

# ERB-RE5R00V Datasheet

[www.digi-electronics.com](http://www.digi-electronics.com)

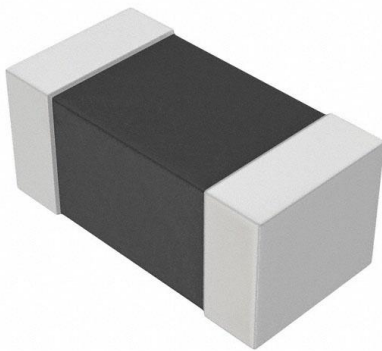

<https://www.DiGi-Electronics.com>

DiGi Electronics Part Number	ERB-RE5R00V-DG
Manufacturer	<a href="#">Panasonic Electronic Components</a>
Manufacturer Product Number	ERB-RE5R00V
Description	FUSE BOARD MOUNT 5A 32VDC 0603
Detailed Description	5 A AC 32 V DC Fuse Board Mount (Cartridge Style Excluded) Surface Mount 0603 (1608 Metric)

This model ERB-RE5R00V is available at DiGi Electronics.

DiGi Electronics offers a global database of semiconductor and electronic component datasheets.

We welcome your inquiries regarding pricing, lead time, or other product-related questions.

 [Request a Quote](#)

 [Datasheet Search](#)



Tel: +00 852-30501935

RFQ Email: [Info@DiGi-Electronics.com](mailto:Info@DiGi-Electronics.com)

DiGi is a global authorized distributor of electronic components.

## Purchase and inquiry

Manufacturer Product Number:

ERB-RE5R00V

Series:

ERB-RE

Mounting Type:

Surface Mount

Current Rating (Amps):

5 A

Response Time:

Fast Blow

Breaking Capacity @ Rated Voltage:

50A

Operating Temperature:

-40°C ~ 125°C

Size / Dimension:

0.063" L x 0.032" W x 0.025" H (1.60mm x 0.81mm x 0.63mm)

Base Product Number:

ERB-RE

Manufacturer:

Panasonic Electronic Components

Product Status:

Active

Fuse Type:

Board Mount (Cartridge Style Excluded)

Voltage Rating - DC:

32 V

Package / Case:

0603 (1608 Metric)

Approval Agency:

cUL, UL

Color:

-

DC Cold Resistance:

0.019 Ohms

## Environmental & Export classification

RoHS Status:

ROHS3 Compliant

REACH Status:

REACH Unaffected

HTSUS:

8536.10.0040

Moisture Sensitivity Level (MSL):

1 (Unlimited)

ECCN:

EAR99



# Micro Chip Fuse

## ERB RD, RE, RG type

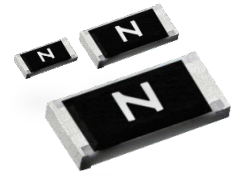

### Features

- Small size
- Fast-acting and withstanding in-rush current characteristics
- RoHS compliant

### Approved safety standards

UL248-14 : File No.E194052  
 c-UL C22.2 No.248-14 : File No.E194052

### Explanation of part numbers

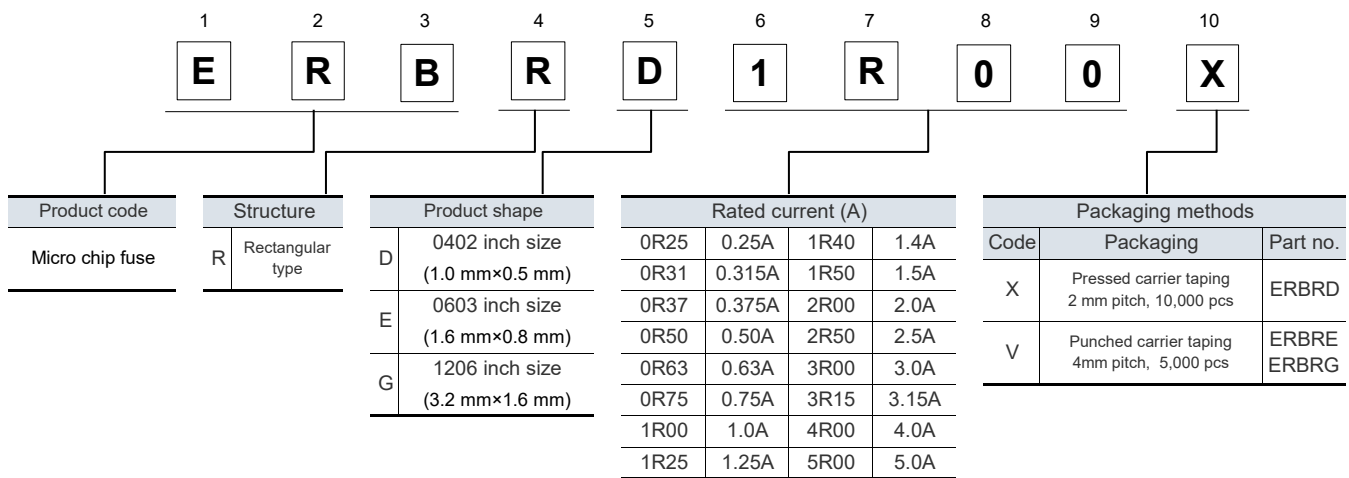

### Construction

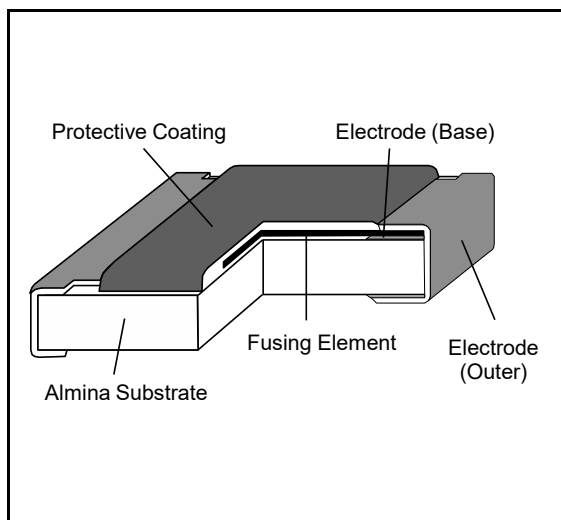

### Dimensions in mm (not to scale)

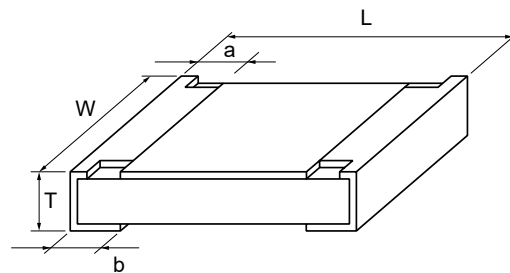

Part No. (inch size)	Dimensions (mm)					Mass (Weight) (g/1000 pcs)
	L	W	a	b	T	
ERBRD (0402)	1.00±0.10	0.50 <sup>+0.10</sup> <sub>-0.05</sub>	0.15±0.10	0.25±0.10	0.39±0.10	0.7
ERBRE (0603)	1.60±0.15	0.80 <sup>+0.15</sup> <sub>-0.05</sub>	0.24±0.15	0.30±0.15	0.54±0.10	2.2
ERBRG (1206)	3.20±0.20	1.60±0.15	0.30±0.20	0.55±0.20	0.65±0.10	10

**Ratings**

● 0402 inch / 1005 mm size : Type ERBRD

Part No.	ERBRD□R□□X													
	0R25	0R31	0R37	0R50	0R63	0R75	1R00	1R25	1R50	2R00	2R50	3R00	4R00	5R00
Rated current (A)	0.25	0.315	0.375	0.5	0.63	0.75	1.0	1.25	1.5	2.0	2.5	3.0	4.0	5.0
Marking code	V	X	Y	F	6	G	H	J	K	N	O	P	S	T
Internal R(mΩ) at 25 °C max.	700	520	440	310	220	190	125	82	70	53	42	37	24	19.5
Fusing current/ Fusing time (at 25 °C)	Rated current ×100 % /4 hours min.													
	Rated current ×200 % / 5 seconds max.													
	Rated current ×300 % /0.2 seconds max.													
Rated voltage (Open circuit voltage) (V)DC	32													
Interrupting rating at rated voltage(A)	35													
Category temp. range (°C)	-40 to +125													

● 0603 inch / 1608 mm size : Type ERBRE

Part No.	ERBRE□R□□V											
	0R50	0R75	1R00	1R25	1R40	1R50	2R00	2R50	3R00	3R15	4R00	5R00
Rated current (A)	0.5	0.75	1.0	1.25	1.4	1.5	2.0	2.5	3.0	3.15	4.0	5.0
Marking code	F	G	H	J	14	K	N	O	P	31	S	T
Internal R(mΩ) at 25 °C max.	330	190	125	94	85	72	51	40	33	32	22	19
Fusing current/ Fusing time (at 25 °C)	Rated current ×100 % /4 hours min.											
	Rated current ×200 % / 5 seconds max.											
	Rated current ×300 % /0.2 seconds max.											
Rated voltage (Open circuit voltage) (V)DC	32											
Interrupting rating at rated voltage(A)	50											
Category temp. range (°C)	-40 to +125											

● 1206 inch / 3216 mm size : Type ERBRG

Part No.	ERBRG□R□□V									
	0R50	0R75	1R00	1R25	1R50	2R00	2R50	3R00	4R00	
Rated current (A)	0.5	0.75	1.0	1.25	1.5	2.0	2.5	3.0	4.0	
Marking code	F	G	H	J	K	N	O	P	S	
Internal R(mΩ) at 25 °C max.	560	340	210	175	115	85	65	45	35	
Fusing current/ Fusing time (at 25 °C)	Rated current ×100 % /4 hours min.									
	Rated current ×200 % / 5 seconds max.									
	Rated current ×300 % /0.2 seconds max.									
Rated voltage (Open circuit voltage) (V)DC	63					32				
Interrupting rating at rated voltage(A)	50									
Category temp. range (°C)	-40 to +125									

\*The thin type is available about 1005 (0402 inch) size. Please contact us for details.

\*Please contact us when another rated current is needed.

**Fusing characteristics (25 °C typical)**

● 0402 inch / 1005 mm size

(Type ERBRD)

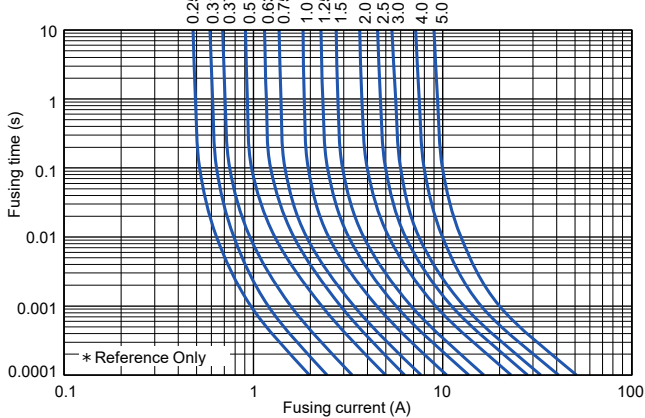

● 0603 inch / 1608 mm size

(Type ERBRE)

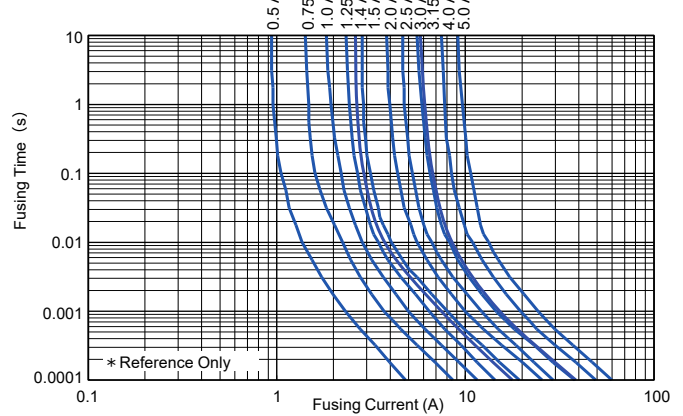

● 1206 inch / 3216mm size

(Type ERBRG)

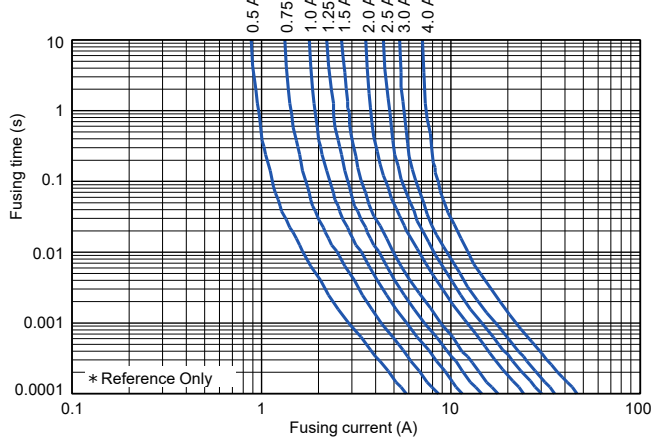

**Performance**

Test Item	Performance requirements	Test conditions
Resistance	Within specified tolerance	25 °C
Resistance to aging heat	±10 %	260 °C±5 °C, 10 s
Rapid change of temperature	±10 %	-40 °C (30 min.) / + 125 °C (30 min.), 5 cycles
Damp heat, Steady state	±10 %	60 °C, 90 % to 95 %RH, 1000 h (no load)
Load life in humidity	±10 %	60 °C, 90 % to 95 %RH, Load: 70 % rated current, 1000 h
Endurance at 70 °C	±10 %	70 °C, Load: 70 % rated current, 1000 h

**Recommended soldering conditions**

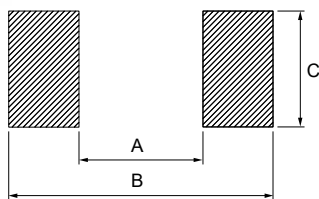

Part no. (inch size)	Dimensions (mm)		
	A	B	C
ERBRD (0402)	0.5 to 0.6	1.4 to 1.6	0.4 to 0.6
ERBRE (0603)	0.7 to 0.9	2.0 to 2.2	0.8 to 1.0
ERBRG (1206)	2.0 to 2.4	4.4 to 5.0	1.2 to 1.8

**Packaging methods (Taping)**

● Standard quantity

Part No.	Size (inch)	Kind of Taping	Pitch (P <sub>1</sub> )	Quantity
ERBRD	0402	Pressed Carrier Taping	2 mm	10,000 pcs / reel
ERBRE	0603	Punched Carrier Taping	4 mm	5,000 pcs / reel
ERBRG	1206			

● Carrier taping

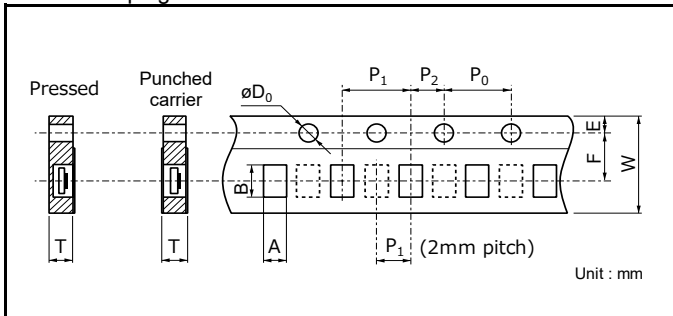

Part no.	A	B	W	F	E
ERBRD	0.68 <sup>+0.10</sup>	1.20 <sup>+0.10</sup>	8.00 <sup>+0.20</sup>	3.50 <sup>+0.05</sup>	1.75 <sup>+0.10</sup>
ERBRE	1.10 <sup>+0.10</sup>	1.90 <sup>+0.10</sup>			
ERBRG	2.00 <sup>+0.15</sup>	3.60 <sup>+0.20</sup>			

Part no.	P <sub>1</sub>	P <sub>2</sub>	P <sub>0</sub>	øD <sub>0</sub>	T
ERBRD	2.00 <sup>+0.10</sup>	2.00 <sup>+0.05</sup>	4.00 <sup>+0.10</sup>	1.50 <sup>+0.10</sup> <sub>0</sub>	0.67 <sup>+0.07</sup>
ERBRE	4.00 <sup>+0.10</sup>				0.78 <sup>+0.07</sup>
ERBRG					0.84 <sup>+0.07</sup>

● Taping reel

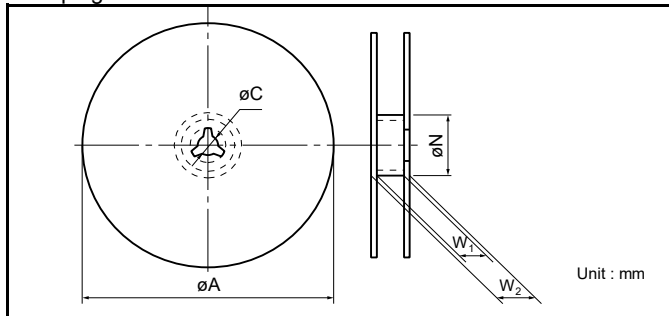

Part no.	øA	øN	øC	W <sub>1</sub>	W <sub>2</sub>
ERBRD ERBRE ERBRG	180.0 <sup>0</sup> <sub>-1.5</sub>	60 <sup>+1.0</sup> <sub>0</sub>	13.0 <sup>+0.2</sup>	9.0 <sup>+1.0</sup> <sub>0</sub>	11.4 <sup>+1.0</sup>

**Recommended soldering conditions**

Recommendations and precautions are described below

● Recommended soldering conditions for reflow

- Reflow soldering shall be performed a maximum of two times.
- Please contact us for additional information when used in conditions other than those specified.
- Please measure the temperature of the terminals and study every kind of solder and printed circuit board for solderability before actual use.

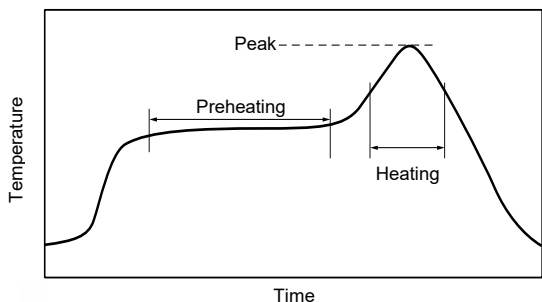

For soldering (Example : Sn/Pb)

	Temperature	Time
Preheating	140 °C to 160 °C	60 s to 120 s
Main heating	Above 200 °C	30 s to 40 s
Peak	235 ± 5 °C	max. 10 s

For lead-free soldering (Example : Sn/Ag/Cu)

	Temperature	Time
Preheating	150 °C to 180 °C	60 s to 120 s
Main heating	Above 230 °C	30 s to 40 s
Peak	max. 260 °C	max. 10 s

● Recommended soldering conditions for flow

	For soldering		For lead-free soldering	
	Temperature	Time	Temperature	Time
Preheating	140 °C to 160 °C	60 s to 120 s	150 °C to 180 °C	60 s to 120 s
Soldering	245±5 °C	20 s to 30 s	max. 260 °C	max. 10 s

«Repair with hand soldering»

- Preheat with a blast of hot air or similar method. Use a soldering iron with a tip temperature of 350 °C or less. Solder each electrode for 3 seconds or less.
- Never touch this product with the tip of a soldering iron.

## Safety and Legal Matters to Be Observed

### Product specifications and applications

- Please be advised that this product and product specifications are subject to change without notice for improvement purposes. Therefore, please request and confirm the latest delivery specifications that explain the specifications in detail before the final design, or purchase or use of the product, regardless of the application. In addition, do not use this product in any way that deviates from the contents of the company's delivery specifications.
- Unless otherwise specified in this catalog or the product specifications, this product is intended for use in general electronic equipment (AV products, home appliances, commercial equipment, office equipment, information and communication equipment, etc.).  
When this product is used for the following special cases, the specification document suited to each application shall be signed/sealed (with Panasonic Industry and the user) in advance..These include applications requiring special quality and reliability, wherein their failures or malfunctions may directly threaten human life or cause harm to the human body (e.g.: space/aircraft equipment, transportation/traffic equipment, combustion equipment, medical equipment, disaster prevention/crime prevention equipment, safety equipment, etc.).

### Safety design and product evaluation

- Please ensure safety through protection circuits, redundant circuits, etc., in the customer's system design so that a defect in our company's product will not endanger human life or cause other serious damage.
- This catalog shows the quality and performance of individual parts. The durability of parts varies depending on the usage environment and conditions. Therefore, please ensure to evaluate and confirm the state of each part after it has been mounted in your product in the actual operating environment before use.  
If you have any doubts about the safety of this product, then please notify us immediately, and be sure to conduct a technical review including the above protection circuits and redundant circuits at your company.

### Laws / Regulations / Intellectual property

- The transportation of dangerous goods as designated by UN numbers, UN classifications, etc., does not apply to this product. In addition, when exporting products, product specifications, and technical information described in this catalog, please comply with the laws and regulations of the countries to which the products are exported, especially those concerning security export control.
- Each model of this product complies with the RoHS Directive (Restriction of the use of hazardous substances in electrical and electronic equipment) (2011/65/EU and (EU) 2015/863). The date of compliance with the RoHS Directive and REACH Regulation varies depending on the product model.  
Further, if you are using product models in stock and are not sure whether or not they comply with the RoHS Directive or REACH Regulation, please contact us by selecting "Sales Inquiry" from the inquiry form.
- During the manufacturing process of this product and any of its components and materials to be used, Panasonic Industry does not intentionally use ozone-depleting substances stipulated in the Montreal Protocol and specific bromine-based flame retardants such as PBBs (Poly-Brominated Biphenyls) / PBDEs (Poly-Brominated Diphenyl Ethers). In addition, the materials used in this product are all listed as existing chemical substances based on the Act on the Regulation of Manufacture and Evaluation of Chemical Substances.
- With regard to the disposal of this product, please confirm the disposal method in each country and region where it is incorporated into your company's product and used.
- The technical information contained in this catalog is intended to show only typical operation and application circuit examples of this product. This catalog does not guarantee that such information does not infringe upon the intellectual property rights of Panasonic Industry or any third party, nor imply that the license of such rights has been granted.
- Design, materials, or process related to technical owned by Panasonic Industry are subject to change without notice.

**Panasonic Industry will assume no liability whatsoever if the use of our company's products deviates from the contents of this catalog or does not comply with the precautions. Please be advised of these restrictions.**

## Matters to Be Observed When Using This Product (Rectangular chip fuse)

### Use environments and cleaning conditions

- This product (Fuses) is not designed for use in specific environments. Using the fuses in the following specific environments or service conditions may affect the performance/reliability. Avoid using it in such specific environments. If you intend to use the fuses in such environments, checking the performance, reliability, etc., of the product sufficiently is your own responsibility.
  - (1) Used in liquid, such as water, oil, chemicals, and organic solvents.
  - (2) Used in a place exposed to direct sunlight, an outdoor place with no shielding, or a dusty place.
  - (3) Used in a place where the product is heavily exposed to sea breeze or a corrosive gas, such as Cl<sub>2</sub>, H<sub>2</sub>S, NH<sub>3</sub>, SO<sub>2</sub>, or NO<sub>x</sub>.
  - (4) Used in an environment where static electricity and electromagnetic waves are strong.
  - (5) Located close to a heating component or a flammable material, such as a vinyl cable placed near the product.
  - (6) Sealed or coated with a resin.
  - (7) Solder flux of the resistor soldered with no-clean type solder, etc., is cleansed with a solvent, water, or a water-soluble cleaner, etc. (Water-soluble flux residues have a particularly large influence on a resistor.)
  - (8) Used in a place where dew concentrates on the product.
  - (9) Used in a contaminated state.  
(Example: Touching the resistor mounted on a printed board leaving sebum on the fuses (improper handling))
- Sealing the fuses with a resin in a resin potting process, damp-proofing process, etc., applies excessive stress to the fuses, which may cause the internal electrodes a connection problem. In such cases, the proper operation of the fuses is not guaranteed. If you intend to use the resistor in such environments, checking the performance, reliability, etc., of the product sufficiently is your own responsibility.
- Do not leave the fuses immersed in a solvent for a long time. When using the fuses immersed in a solvent, confirm the operation of the product mounted on the board.
- When a cleaning solution or cleaning condition for cleaning the printed board or a drying condition for drying the printed board after soldering the fuses is improper, it may have a negative effect on the performance/reliability of the fuses. Confirming these conditions sufficiently is your own responsibility. Also examine the effects of soiled cleaning agent, cleaning residues, and post-cleaning contaminations, and control for these effects properly.

### Response to anomalies and handling conditions

- When the fuses is heating abnormally or emitting a smell, stop using the fuses immediately, for example, turn off the main power supply of the device.  
Also, keep your face and hands away from the product as it may become hot and cause burns.
- The fuses is so thin that it may break easily when subjected to impact. Before putting the fuses in use, confirm that the fuses has not been broken by impact that applied thereto when mounted on the printed board. Applying impact to the fuses or pinching the fuses with a hard tool (pliers, tweezers, etc.) may the fuses or its protective film, which affects its performance. Be careful to avoid such cases.
- Do not reuse a fuses having been used on a printed board and removed therefrom. Do not touch the fuses with your bare hands.
- Be careful not to drop the fuses on the floor, etc. The fuses is likely to suffer mechanical or electrical damage when dropped on the floor. Avoid using said fuses.
- The fuses may have its resistance value changed due to electrostatic discharge (ESD). Take ESD prevention measures when handling the fuses. ESD prevention measures include an environment where static electricity is not likely to be generated (recommended RH: 40% to 60%), by wearing an earth band, conductive gloves, etc., grounding the device in which the fuses is incorporated, and placing a conductive mat, etc., on a work platform.
- Select a rated current for the chip fuse so that a current flowing through the chip fuse, in a normal condition, is 70% or less of the rated current. Do not let a current larger than the rated current flow continuously through the chip fuse.

- Be careful when a pulse current larger than the rated current, such as an inrush current or surge current at the moment of turning on the power supply, briefly flows through the chip fuse. It may cause the chip fuse to fuse off, which is undesirable. Calculate the  $I^2t$  value of the pulse current, and from the  $I^2t$ -t characteristics curve, determine the tolerance of the chip fuse to the number of pulses applied. Based on these  $I^2t$  value and tolerance, make a decision on whether or not to use the chip fuse. Determining the tolerance involves technicalities. Consult our sales staff in advance.
- The product fuses off when carrying a current two times or more of the rated current. Select a product so that the abnormal current generated in the event of a circuit failure of your product is at least twice the rated current of the product. Make sure that the abnormal current does not exceed the maximum cutoff current of the product.
- The chip fuse is intended for use on the secondary side of the power supply. Do not use the fuse on the primary side of the power supply. Keep source voltage applied to the chip fuse equal to or lower than the rated voltage of the chip fuse.
- The load characteristics and fuse characteristics of the chip fuse are affected by the ambient temperature. Before actually using the chip fuse, evaluate and confirm the operation of the chip fuse incorporated in your product while sufficiently taking into consideration the category temperature range.

### Circuit design and circuit board design

- To prevent a case where a transient load (e.g., a pulse for a short period) too large for the product to handle is applied, make sure to evaluate and confirm the operation of the product incorporated in your product. Applying power or voltage (current) larger than the rated power or rated voltage (current) to the fuses may impair its performance and reliability. Make sure to use the fuses with power or voltage (current) equal to or lower than the rated power or rated voltage (current). The product warranty does not cover usage where an excessively large load, such as a pulse current, is applied to the product.
- The fuses may have a high temperature even when used with power equal to or lower than the rated power. Be careful in such cases. Another factor to be considered are effects on the board, peripheral components, etc., and the effects of peripheral components on the fuses. Make sure to confirm first that the temperature of the fuse elements incorporated in your product is equal to or lower than the specified temperature, and then use the fuses.
- Continuously using the chip fuse in a fused state is not allowed.  
When the chip fuse fuses off, immediately turn off the power supply to cut off the current flow.
- When a fuses is used in a high-frequency circuit, the fuses may fail to offer the required characteristics. Check whether the fuses offers the required characteristics in the actual circuit in which the fuses are incorporated.
- Be careful that unusual stress caused by an excessive bend of the printed board is not applied to the fuses. Design the circuit structure such that the fuses is not close to a perforated line for board splitting or on a line with sizable holes bored on the board.
- When a different component is mounted on the board where the fuses has been soldered, be careful that the board does not bend excessively. If necessary, provide the board with backup pins (support pins) to keep it straight.
- Avoid manual board splitting. Use a jig, etc., to break the board so that it does not bend excessively when split apart.

### Mounting conditions

- When the product is used under mounting conditions departing from mounting conditions specified in our specification sheet, the product may be exposed to unexpected stress to fail. Be careful to avoid such a case. When mounting the fuses on a printed board, set the fuses's front and back surfaces in the direction indicated by the tape. Make sure to evaluate and confirm the operation of the fuses incorporated in your product and determine whether the fuses is usable as a component of the product.
- Set soldering conditions for the fuses within the recommended soldering conditions specified by our company. Any time, soldering condition departing from the specified soldering condition, such as a high peak temperature or a long heating may impair the performance/reliability of the fuses. Note that the specified soldering conditions indicate conditions under which degradation of the fuses characteristics does not occur but do not indicate conditions under which stable soldering can be performed. Check and set individual conditions under which stable soldering can be performed.
- Heat the fuses in advance so that a difference between the soldering temperature and the temperature of the fuses surface is reduced to 100 °C or lower. When dipping the soldered fuses in a solvent, etc., to cool fuse elements rapidly, ensure that the temperature difference between the fuses and the solvent is 100 °C or lower during the dipping.

- When soldering the fuses using a soldering iron, apply hot air, etc., to the fuses to heat it sufficiently in advance and then solder the fuses without bringing the soldering iron tip into contact with the product. If the temperature of the soldering iron tip is high, finish the soldering work quickly (within 3 seconds when the temperature of the soldering iron tip is 350 °C or lower). In the case of a fuses with low resistance, the resistor may fail to offer the exactly intended resistance value because of the variation in the solder volume, etc. Make sure to confirm the resistance value of the fuses in the actual circuit configuration.
- Soldering the fuses with too much solder or too little solder results in the poor reliability of the solder connection of the fuses. Use the proper volume of solder in the soldering process. Sufficiently check for the volume of solder used.
- Soldering with high bond strength or special property solder may affect the quality of the fuses. Do not use such solder.
- Use rosin-based solder flux. When using highly active solder flux made mainly of halogen (chlorine, bromine, etc.), flux residues may affect the performance and reliability of the fuses. Check the effects of flux residues before using the solder flux. Do not use highly acidic flux, water-soluble flux, or flux containing fluoride ions. When solder flux sticks to the fuses after the soldering process, the activation energy of the flux may corrode the fuses and cause it to fail. Prevent solder flux from sticking to the fuses.

## Storage conditions

Keeping the product in the following environments or conditions may lead to degradation of its performance, solderability, etc. Do not keep the product in the following environments.

- (1) Stored in a place where the product is heavily exposed to sea breeze or a corrosive gas, such as Cl<sub>2</sub>, H<sub>2</sub>S, NH<sub>3</sub>, SO<sub>2</sub>, or NO<sub>x</sub>.
- (2) Stored in a place where the product is exposed to direct sunlight.
- (3) Stored in a place where a temperature condition of 5 °C to 35 °C and a relative humidity condition of 45% to 85% cannot be maintained.
- (4) Kept in storage for more than one year from the delivery date.

## OUR CERTIFICATE

DiGi provide top-quality products and perfect service for customer worldwide through standardization, technological innovation and continuous improvement. DiGi through third-party certification, we stricly control the quality of products and services. Welcome your RFQ to

Email: [Info@DiGi-Electronics.com](mailto:Info@DiGi-Electronics.com)



Tel: +00 852-30501935

RFQ Email: [Info@DiGi-Electronics.com](mailto:Info@DiGi-Electronics.com)

DiGi is a global authorized distributor of electronic components.