

UNR421F00A Datasheet

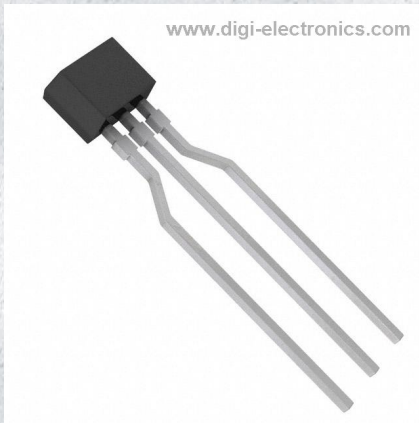

<https://www.DiGi-Electronics.com>

DiGi Electronics Part Number	UNR421F00A-DG
Manufacturer	Panasonic Electronic Components
Manufacturer Product Number	UNR421F00A
Description	TRANS PREBIAS NPN 50V NS-B1
Detailed Description	Pre-Biased Bipolar Transistor (BJT) NPN - Pre-Biased 50 V 100 mA 150 MHz 300 mW Through Hole NS-B1



Tel: +00 852-30501935

RFQ Email: Info@DiGi-Electronics.com

DiGi is a global authorized distributor of electronic components.

Purchase and inquiry

Manufacturer Product Number:

UNR421F00A

Series:

-

Transistor Type:

NPN - Pre-Biased

Voltage - Collector Emitter Breakdown (Max):

50 V

Resistor - Emitter Base (R2):

10 kOhms

Vce Saturation (Max) @ Ib, Ic:

250mV @ 300µA, 10mA

Frequency - Transition:

150 MHz

Mounting Type:

Through Hole

Supplier Device Package:

NS-B1

Manufacturer:

Panasonic Electronic Components

Product Status:

Obsolete

Current - Collector (Ic) (Max):

100 mA

Resistor - Base (R1):

4.7 kOhms

DC Current Gain (hFE) (Min) @ Ic, Vce:

30 @ 5mA, 10V

Current - Collector Cutoff (Max):

500nA

Power - Max:

300 mW

Package / Case:

3-SIP

Base Product Number:

UNR421

Environmental & Export classification

Moisture Sensitivity Level (MSL):

1 (Unlimited)

HTSUS:

8541.21.0075

ECCN:

EAR99

UNR421x Series (UN421x Series)

Silicon NPN epitaxial planar type

For digital circuits

■ Features

- Costs can be reduced through downsizing of the equipment and reduction of the number of parts
- New S type package, allowing supply with the radial taping

■ Resistance by Part Number

	(R ₁)	(R ₂)
• UNR4210 (UN4210)	47 kΩ	—
• UNR4211 (UN4211)	10 kΩ	10 kΩ
• UNR4212 (UN4212)	22 kΩ	22 kΩ
• UNR4213 (UN4213)	47 kΩ	47 kΩ
• UNR4214 (UN4214)	10 kΩ	47 kΩ
• UNR4215 (UN4215)	10 kΩ	—
• UNR4216 (UN4216)	4.7 kΩ	—
• UNR4217 (UN4217)	22 kΩ	—
• UNR4218 (UN4218)	0.51 kΩ	5.1 kΩ
• UNR4219 (UN4219)	1 kΩ	10 kΩ
• UNR421D (UN421D)	47 kΩ	10 kΩ
• UNR421E (UN421E)	47 kΩ	22 kΩ
• UNR421F (UN421F)	4.7 kΩ	10 kΩ
• UNR421K (UN421K)	10 kΩ	4.7 kΩ
• UNR421L (UN421L)	4.7 kΩ	4.7 kΩ

■ Absolute Maximum Ratings T_a = 25°C

Parameter	Symbol	Rating	Unit
Collector-base voltage (Emitter open)	V _{CBO}	50	V
Collector-emitter voltage (Base open)	V _{CEO}	50	V
Collector current	I _C	100	mA
Total power dissipation	P _T	300	mW
Junction temperature	T _j	150	°C
Storage temperature	T _{stg}	-55 to +150	°C

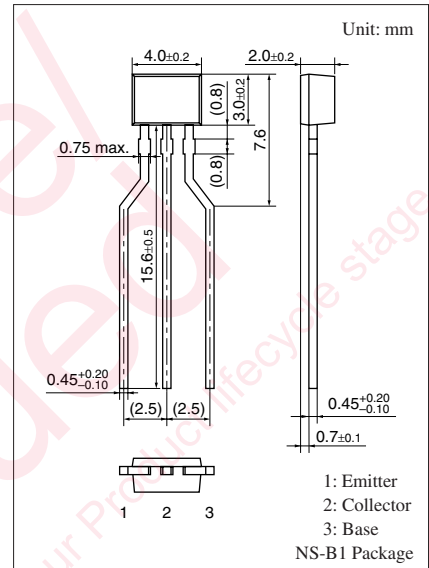

Internal Connection

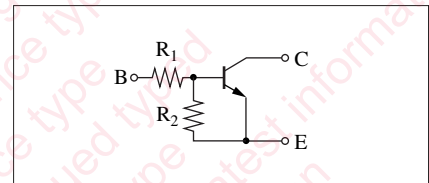

Note) The part numbers in the parenthesis show conventional part number.

■ Electrical Characteristics $T_a = 25^\circ\text{C} \pm 3^\circ\text{C}$

Parameter		Symbol	Conditions	Min	Typ	Max	Unit
Collector-base voltage (Emitter open)		V_{CBO}	$I_C = 10 \mu\text{A}, I_E = 0$	50			V
Collector-emitter voltage (Base open)		V_{CEO}	$I_C = 2 \text{ mA}, I_B = 0$	50			V
Collector-base cutoff current (Emitter open)		I_{CBO}	$V_{CB} = 50 \text{ V}, I_E = 0$			0.1	μA
Collector-emitter cutoff current (Base open)		I_{CEO}	$V_{CE} = 50 \text{ V}, I_B = 0$			0.5	μA
Emitter-base cutoff current (Collector open)	UNR4210/4215/4216/4217	I_{EBO}	$V_{EB} = 6 \text{ V}, I_C = 0$			0.01	mA
	UNR4213					0.1	
	UNR4212/4214/421D/421E					0.2	
	UNR4211					0.5	
	UNR421F/421K					1.0	
	UNR4219					1.5	
	UNR4218/421L					2.0	
Forward current transfer ratio	UNR4218/421K/421L	h_{FE}	$V_{CE} = 10 \text{ V}, I_C = 5 \text{ mA}$	20			—
	UNR4219/421D/421F			30			
	UNR4211			35			
	UNR4212/421E			60			
	UNR4213/4214			80			
	UNR4210*/4215*/4216*/4217*			160		460	
Collector-emitter saturation voltage		$V_{CE(sat)}$	$I_C = 10 \text{ mA}, I_B = 0.3 \text{ mA}$			0.25	V
Output voltage high-level		V_{OH}	$V_{CC} = 5 \text{ V}, V_B = 0.5 \text{ V}, R_L = 1 \text{ k}\Omega$	4.9			V
Output voltage low-level		V_{OL}	$V_{CC} = 5 \text{ V}, V_B = 2.5 \text{ V}, R_L = 1 \text{ k}\Omega$			0.2	V
	UNR4213/421K		$V_{CC} = 5 \text{ V}, V_B = 3.5 \text{ V}, R_L = 1 \text{ k}\Omega$				
	UNR421D		$V_{CC} = 5 \text{ V}, V_B = 10 \text{ V}, R_L = 1 \text{ k}\Omega$				
	UNR421E		$V_{CC} = 5 \text{ V}, V_B = 6 \text{ V}, R_L = 1 \text{ k}\Omega$				
Transition frequency		f_T	$V_{CB} = 10 \text{ V}, I_E = -2 \text{ mA}, f = 200 \text{ MHz}$		150		MHz
Input resistance	UNR4218	R_1		-30%	0.51	+30%	k Ω
	UNR4219				1.0		
	UNR4216/421F/421L				4.7		
	UNR4211/4214/4215/421K				10		
	UNR4212/4217				22		
	UNR4210/4213/421D/421E				47		
Resistance ratio	UNR4218/4219	R_1/R_2		0.08	0.10	0.12	—
	UNR4214			0.17	0.21	0.25	
	UNR421F			0.37	0.47	0.57	
	UNR4211/4212/4213/421L			0.8	1.0	1.2	
	UNR421K			1.70	2.13	2.60	
	UNR421E			1.70	2.14	2.60	
	UNR421D			3.7	4.7	5.7	

Note) 1. Measuring methods are based on JAPANESE INDUSTRIAL STANDARD JIS C 7030 measuring methods for transistors.

2. *: Rank classification

Rank	Q	R	S	No-rank
h_{FE}	160 to 260	210 to 340	290 to 460	160 to 460

Common characteristics chart

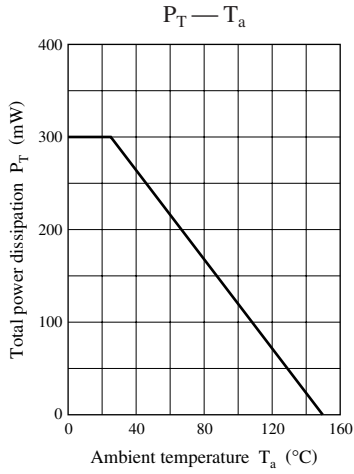

Characteristics charts of UNR4210

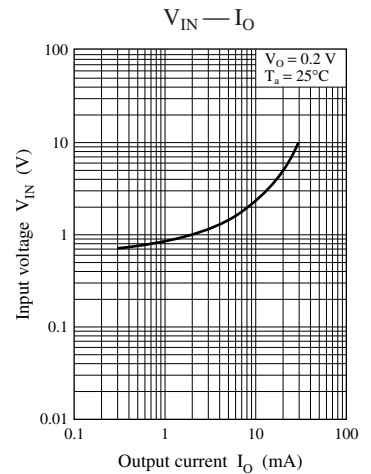
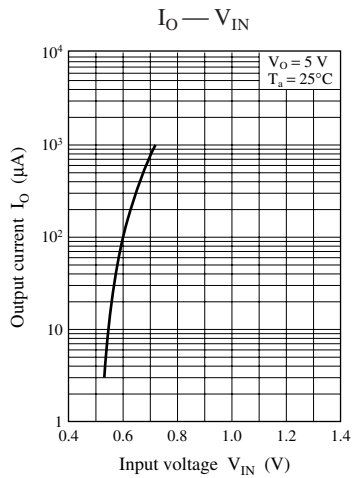
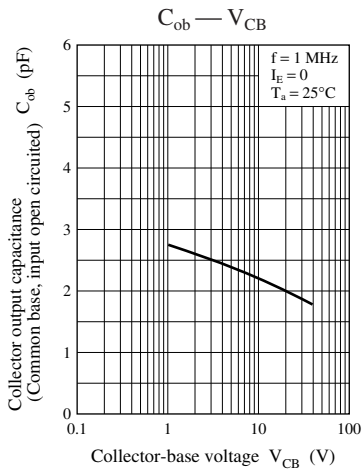
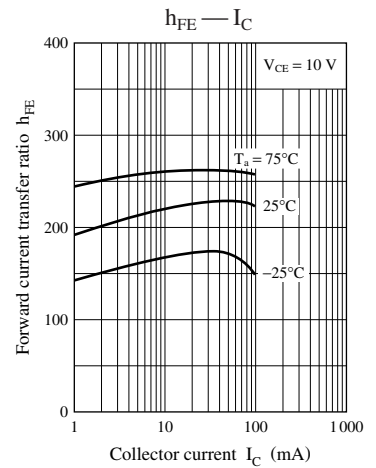
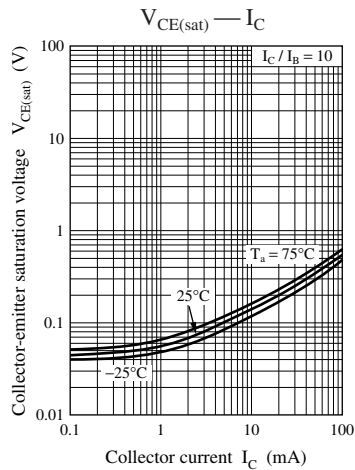
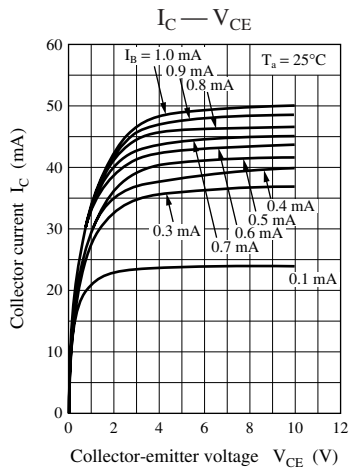

Characteristics charts of UNR4211

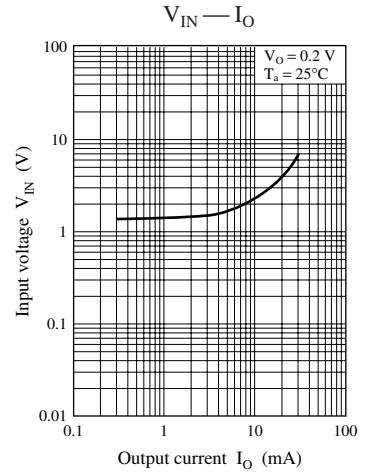
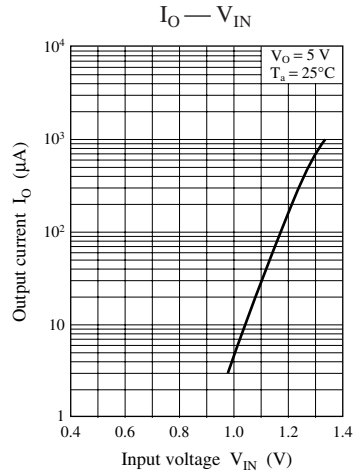
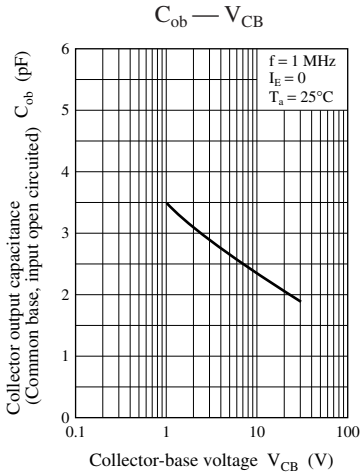
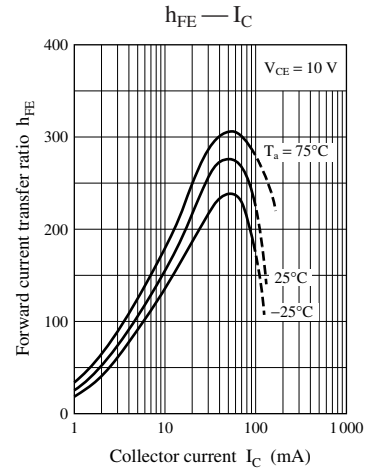
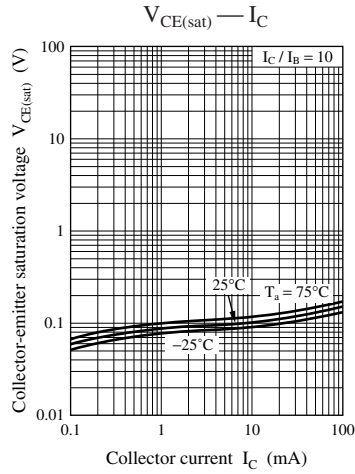
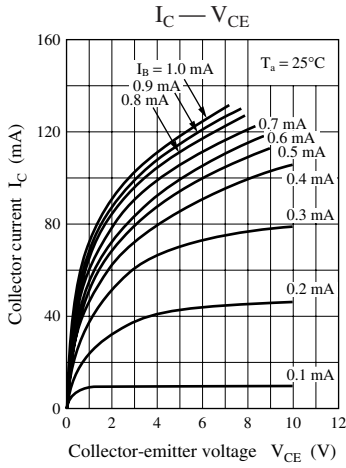

Characteristics charts of UNR4212

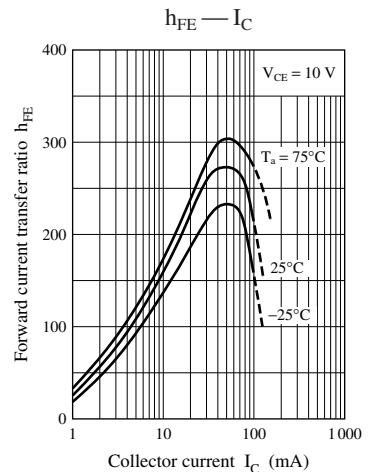
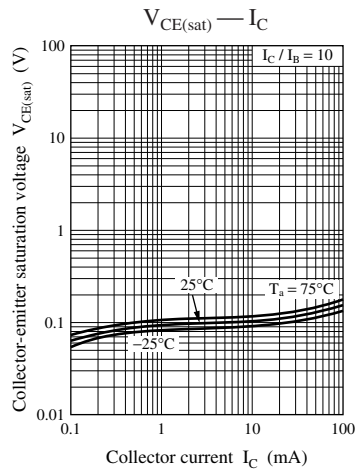
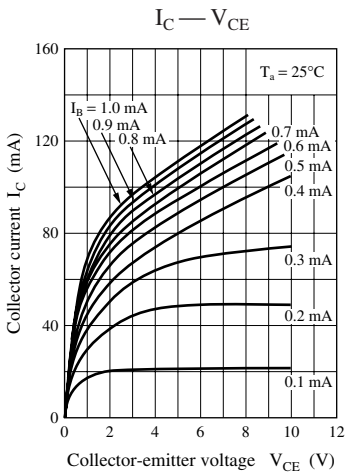

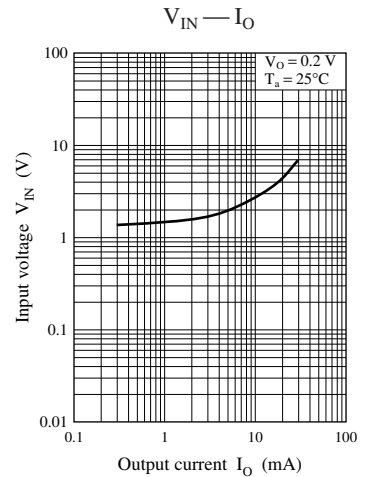
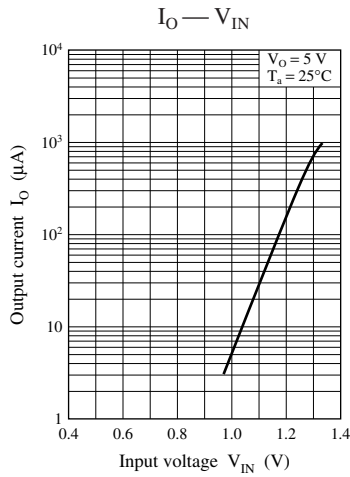
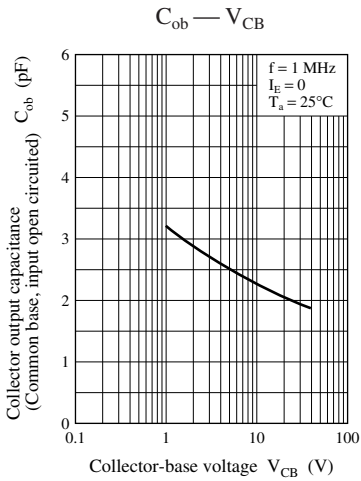

Characteristics charts of UNR4213

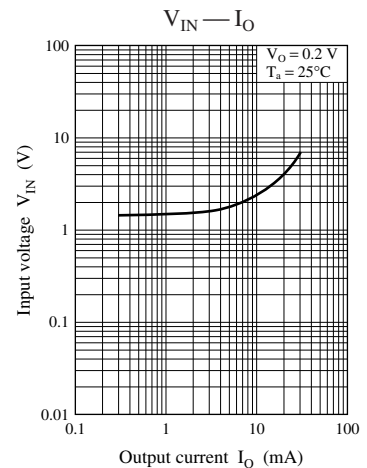
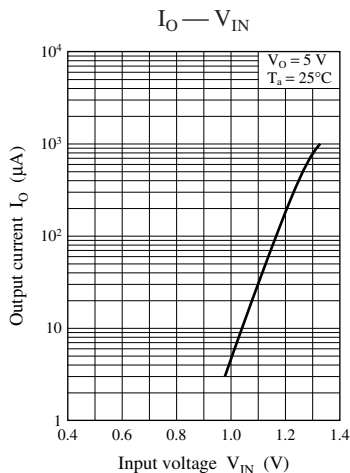
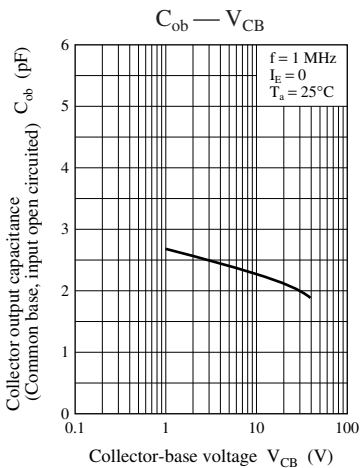
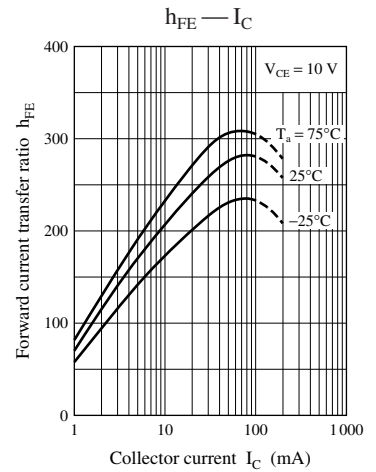
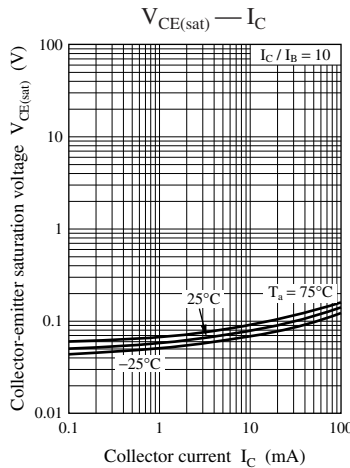
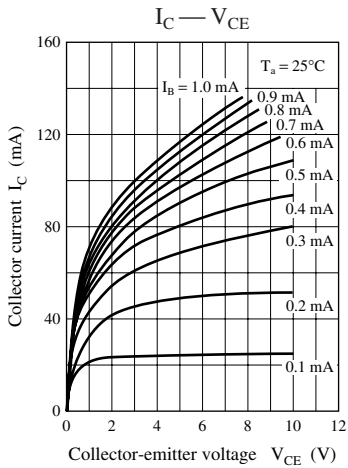

Characteristics charts of UNR4214

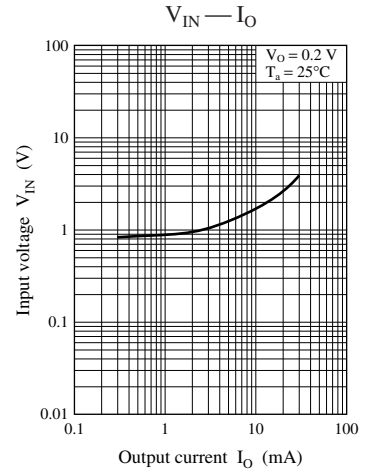
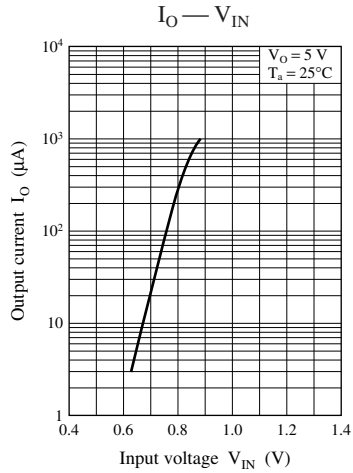
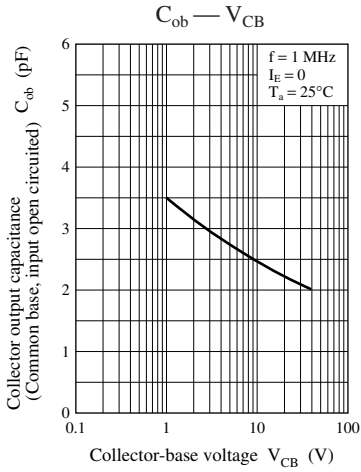
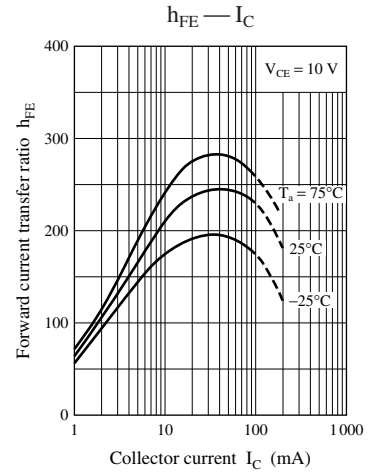
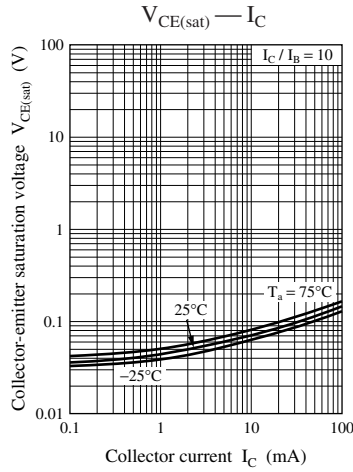
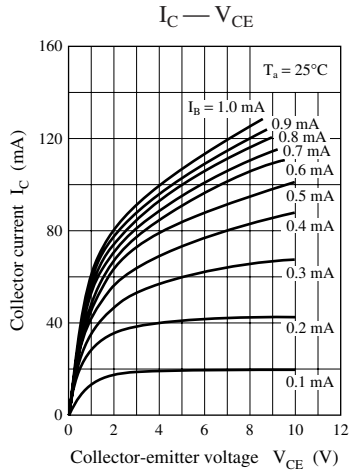

Characteristics charts of UNR4215

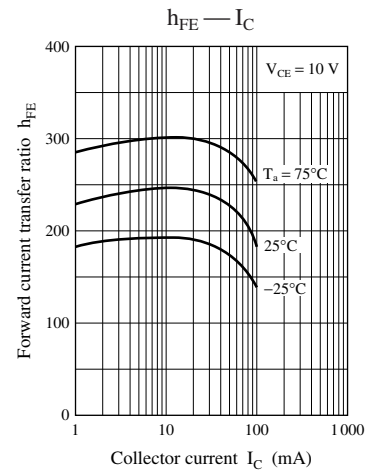
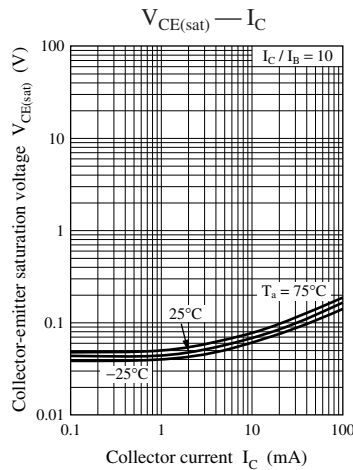
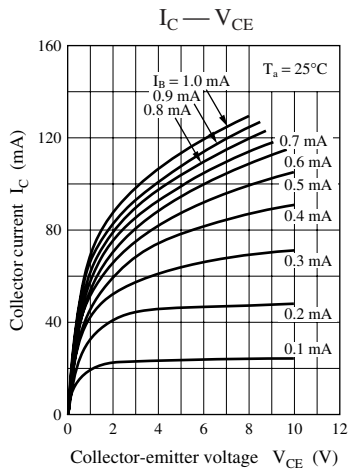

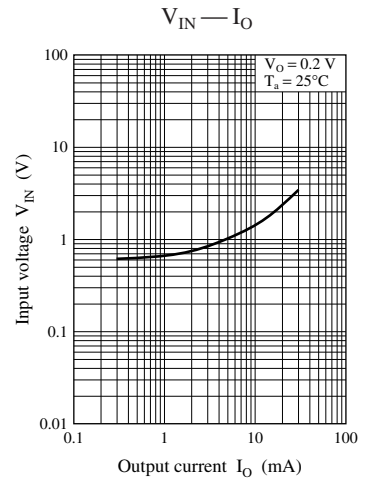
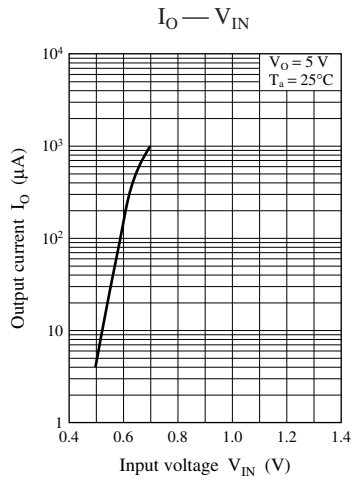
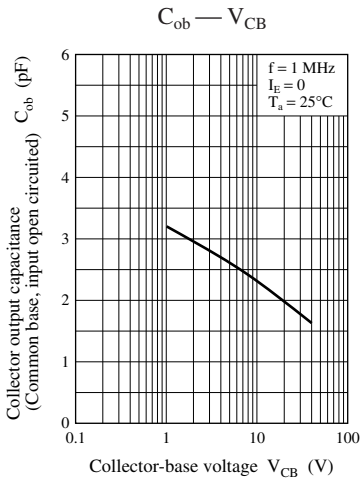

Characteristics charts of UNR4216

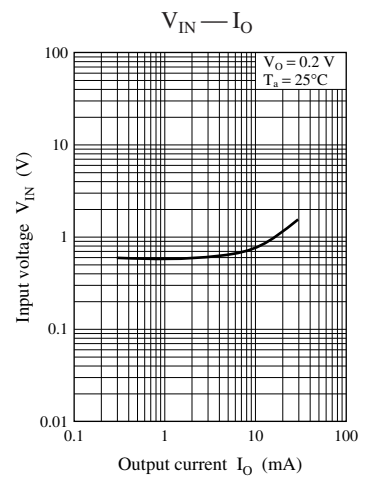
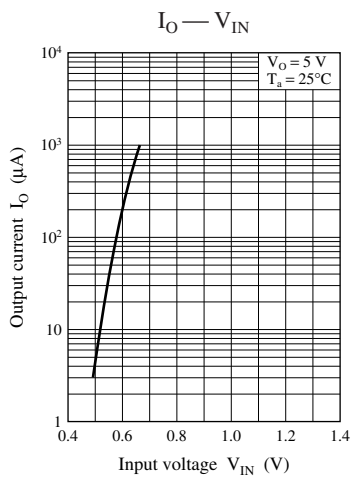
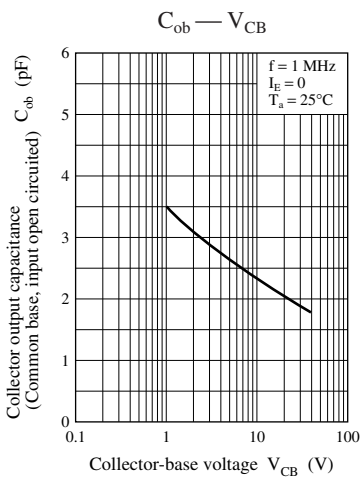
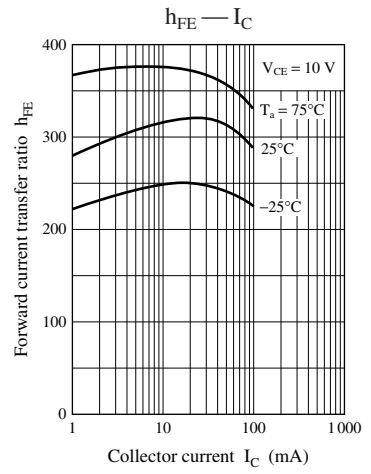
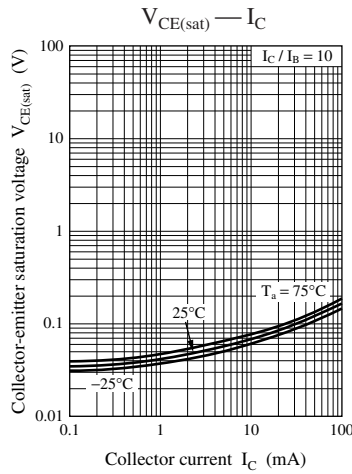
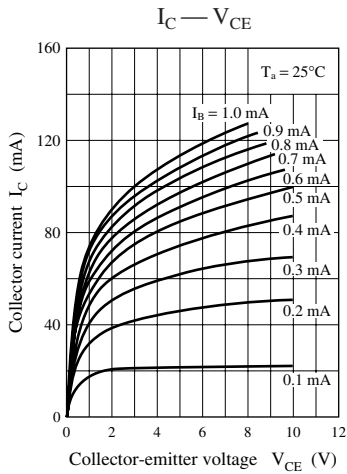

Characteristics charts of UNR4217

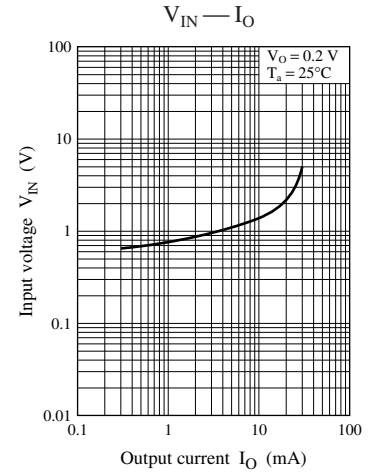
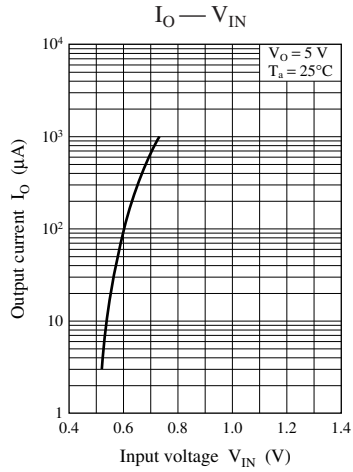
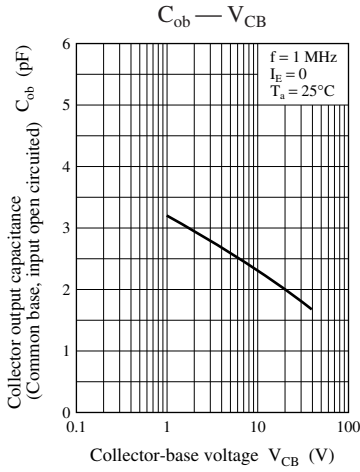
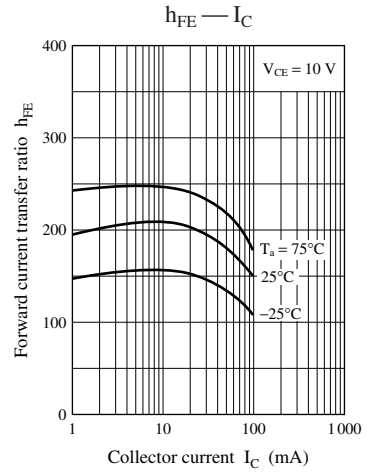
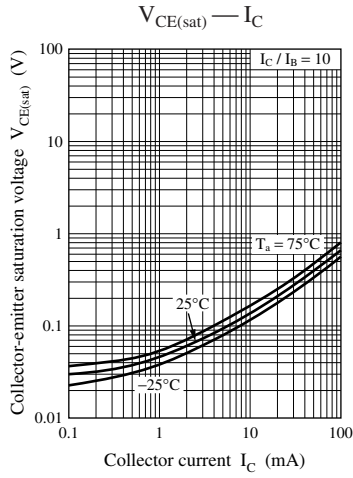
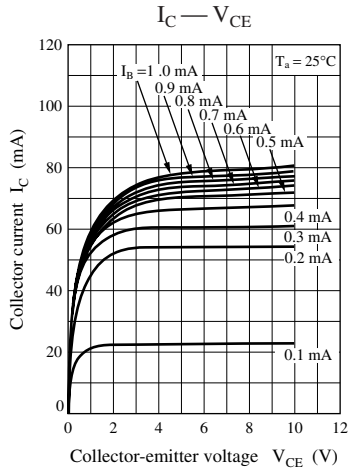

Characteristics charts of UNR4218

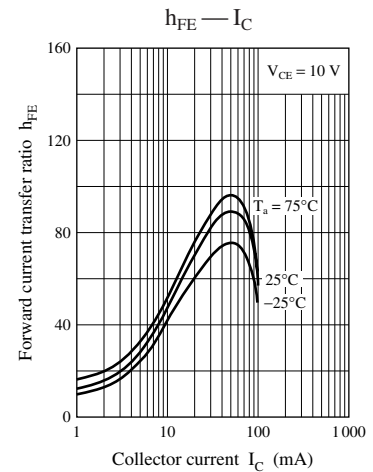
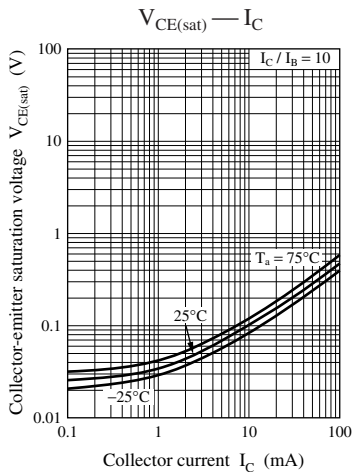
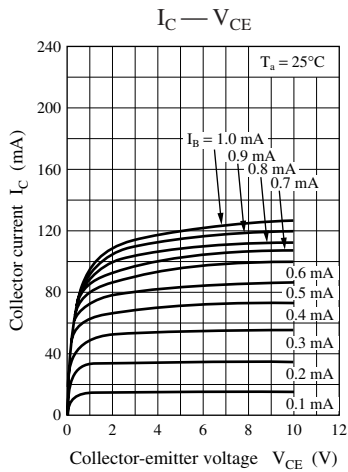

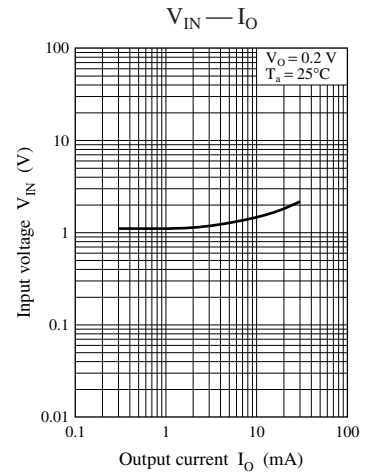
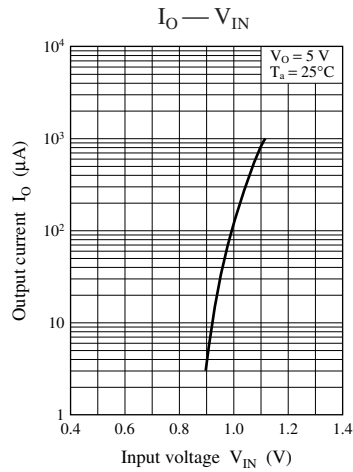
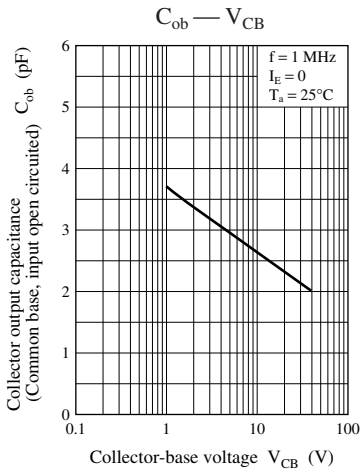

Characteristics charts of UNR4219

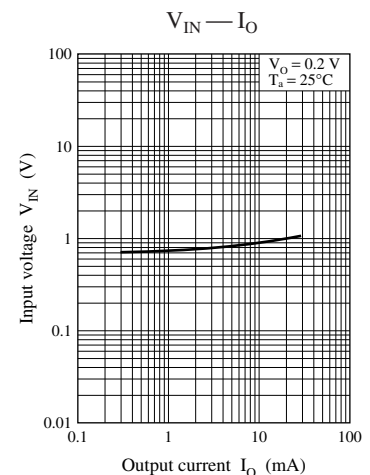
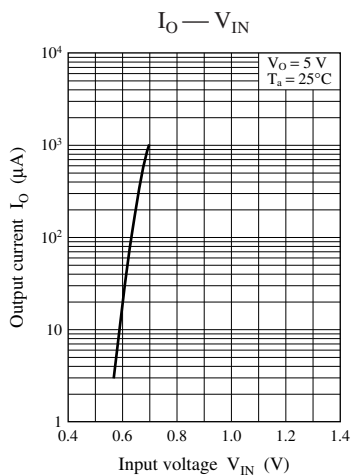
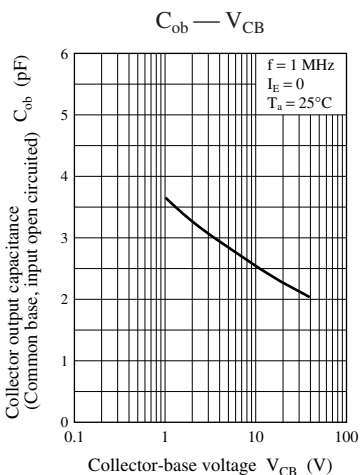
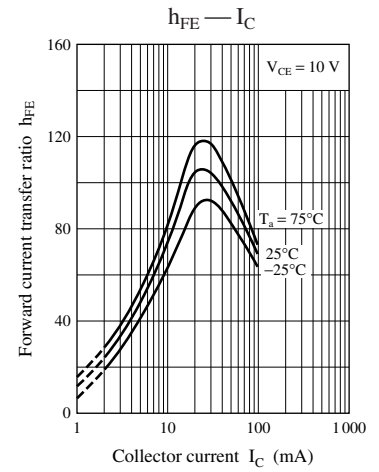
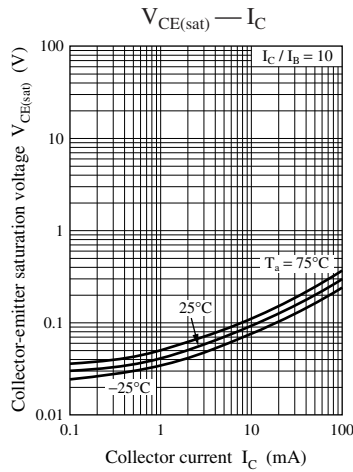
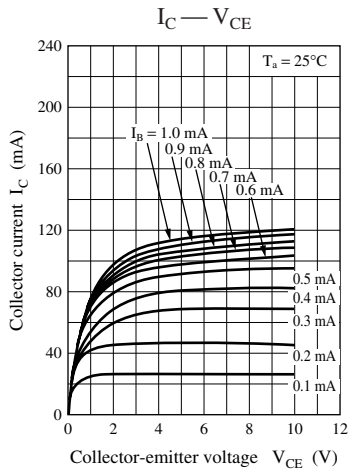

Characteristics charts of UNR421D

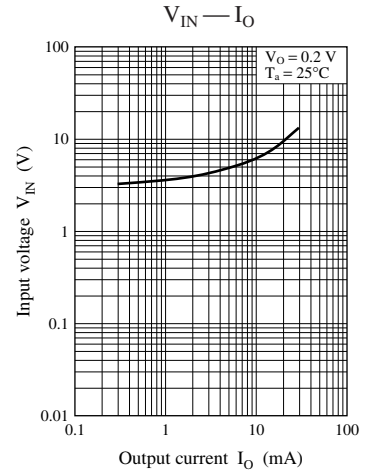
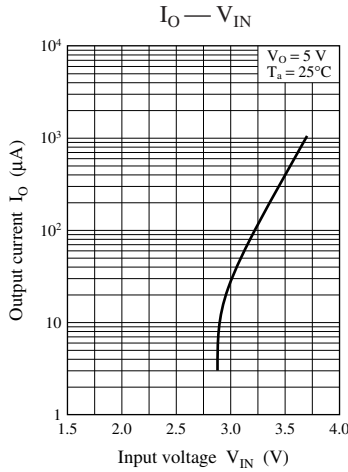
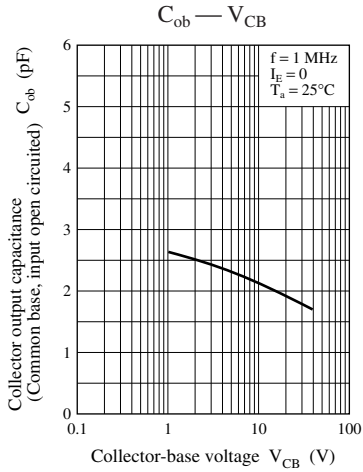
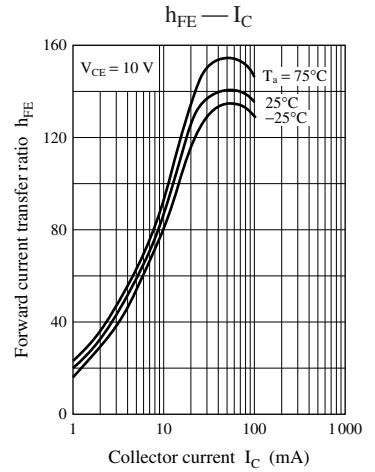
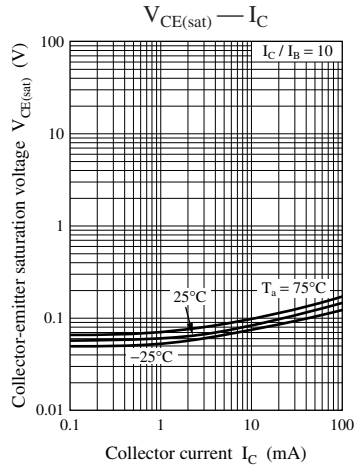
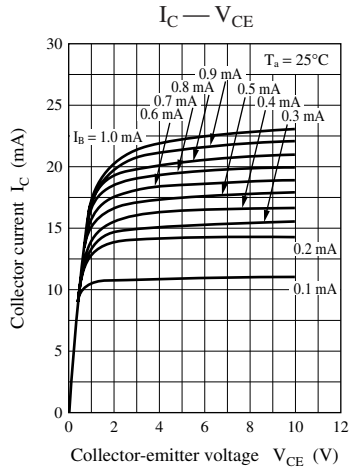

Characteristics charts of UNR421E

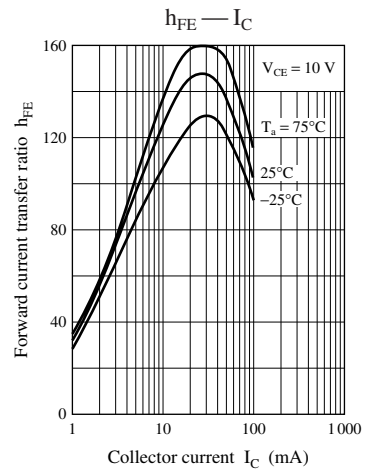
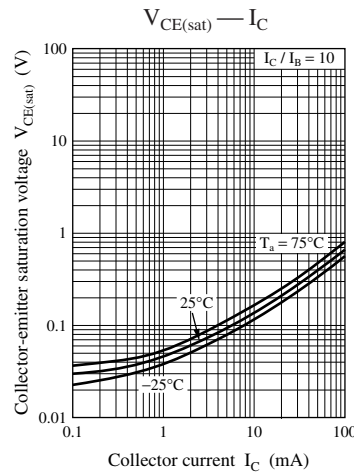
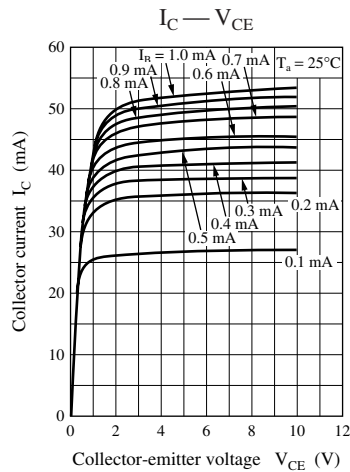

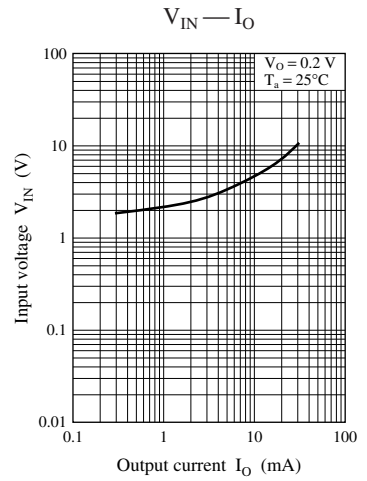
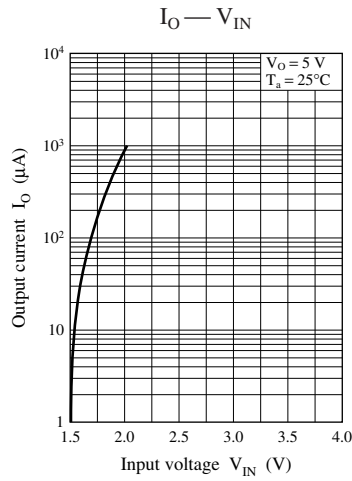
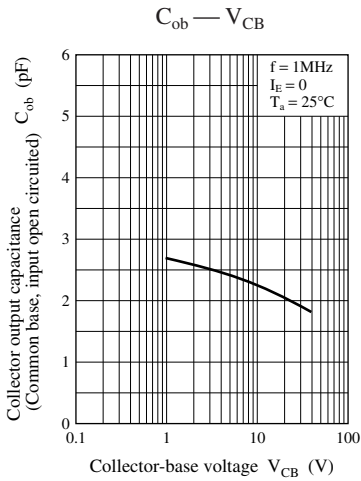

Characteristics charts of UNR421F

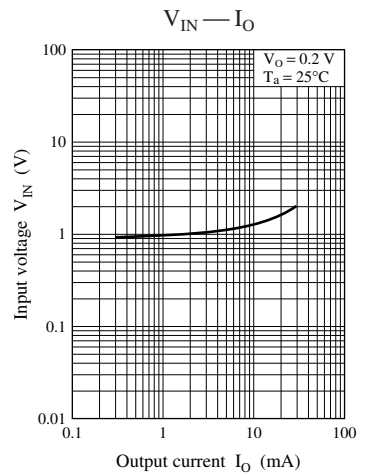
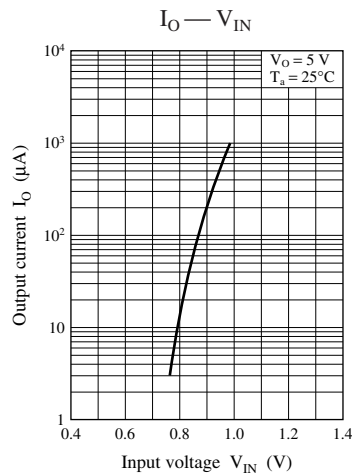
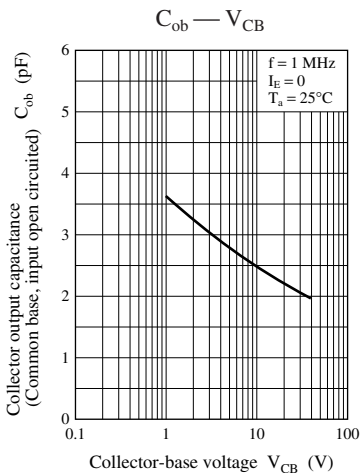
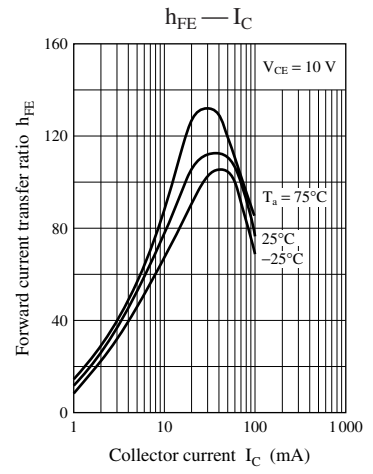
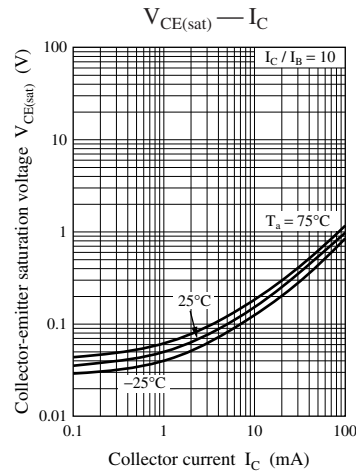
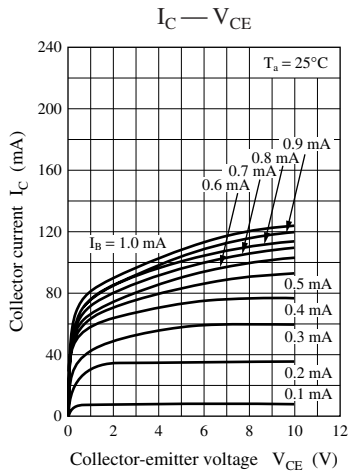

Characteristics charts of UNR421K

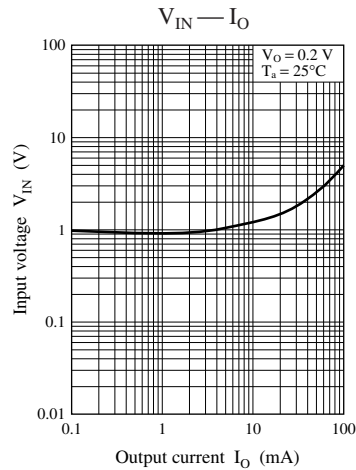
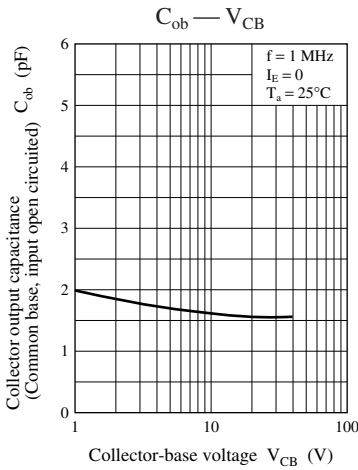
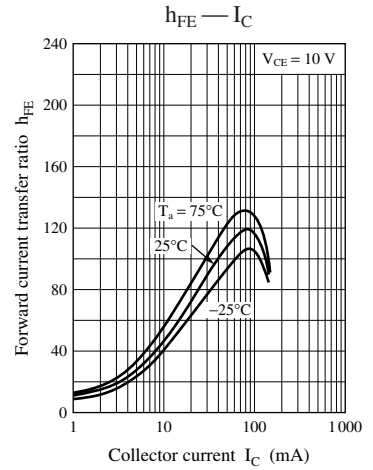
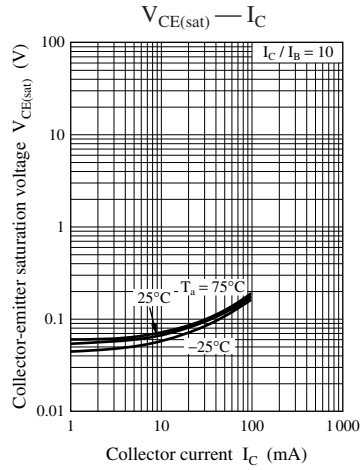
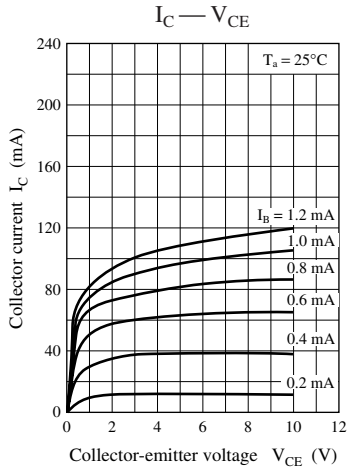

Characteristics charts of UNR421L

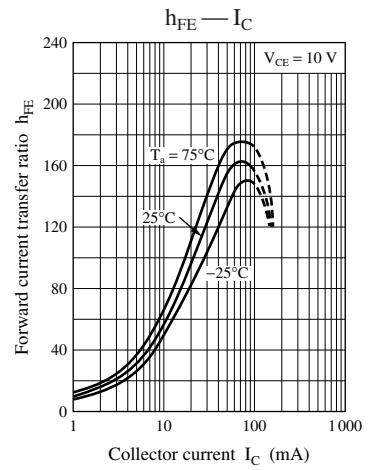
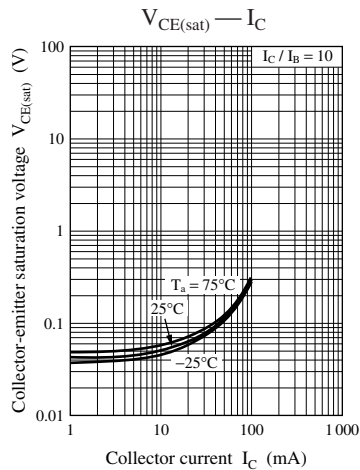
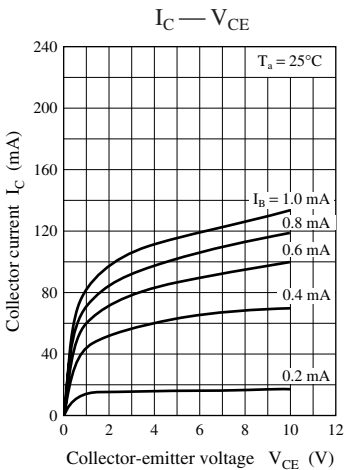

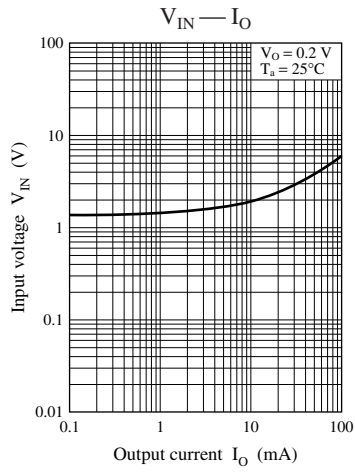
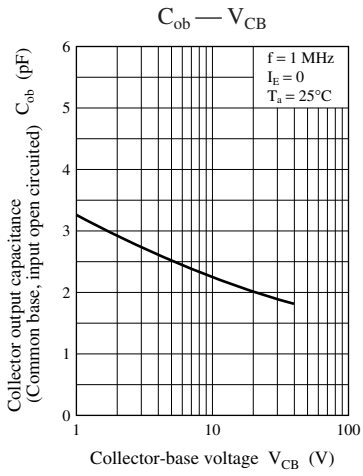

Request for your special attention and precautions in using the technical information and semiconductors described in this book

- (1) If any of the products or technical information described in this book is to be exported or provided to non-residents, the laws and regulations of the exporting country, especially, those with regard to security export control, must be observed.
- (2) The technical information described in this book is intended only to show the main characteristics and application circuit examples of the products, and no license is granted under any intellectual property right or other right owned by our company or any other company. Therefore, no responsibility is assumed by our company as to the infringement upon any such right owned by any other company which may arise as a result of the use of technical information described in this book.
- (3) The products described in this book are intended to be used for standard applications or general electronic equipment (such as office equipment, communications equipment, measuring instruments and household appliances).
Consult our sales staff in advance for information on the following applications:
 - Special applications (such as for airplanes, aerospace, automobiles, traffic control equipment, combustion equipment, life support systems and safety devices) in which exceptional quality and reliability are required, or if the failure or malfunction of the products may directly jeopardize life or harm the human body.
 - Any applications other than the standard applications intended.
- (4) The products and product specifications described in this book are subject to change without notice for modification and/or improvement. At the final stage of your design, purchasing, or use of the products, therefore, ask for the most up-to-date Product Standards in advance to make sure that the latest specifications satisfy your requirements.
- (5) When designing your equipment, comply with the range of absolute maximum rating and the guaranteed operating conditions (operating power supply voltage and operating environment etc.). Especially, please be careful not to exceed the range of absolute maximum rating on the transient state, such as power-on, power-off and mode-switching. Otherwise, we will not be liable for any defect which may arise later in your equipment.
 - Even when the products are used within the guaranteed values, take into the consideration of incidence of break down and failure mode, possible to occur to semiconductor products. Measures on the systems such as redundant design, arresting the spread of fire or preventing glitch are recommended in order to prevent physical injury, fire, social damages, for example, by using the products.
- (6) Comply with the instructions for use in order to prevent breakdown and characteristics change due to external factors (ESD, EOS, thermal stress and mechanical stress) at the time of handling, mounting or at customer's process. When using products for which damp-proof packing is required, satisfy the conditions, such as shelf life and the elapsed time since first opening the packages.
- (7) This book may be not reprinted or reproduced whether wholly or partially, without the prior written permission of Matsushita Electric Industrial Co., Ltd.

OUR CERTIFICATE

DiGi provide top-quality products and perfect service for customer worldwide through standardization, technological innovation and continuous improvement. DiGi through third-party certification, we stricly control the quality of products and services. Welcome your RFQ to

Email: Info@DiGi-Electronics.com



Tel: +00 852-30501935

RFQ Email: Info@DiGi-Electronics.com

DiGi is a global authorized distributor of electronic components.