

TOP256YN Datasheet



<https://www.DiGi-Electronics.com>

DiGi Electronics Part Number	TOP256YN-DG
Manufacturer	Power Integrations
Manufacturer Product Number	TOP256YN
Description	IC OFFLINE SW FLYBACK TO220-7C
Detailed Description	Converter Offline Flyback Topology 66kHz, 132kHz TO-220-7C

This model TOP256YN is available at DiGi Electronics.

DiGi Electronics offers a global database of semiconductor and electronic component datasheets.

We welcome your inquiries regarding pricing, lead time, or other product-related questions.

 [Request a Quote](#)

 [Datasheet Search](#)



Tel: +00 852-30501935

RFQ Email: Info@DiGi-Electronics.com

DiGi is a global authorized distributor of electronic components.

Purchase and inquiry

Manufacturer Product Number:

TOP256YN

Series:

TOPSwitch®-HX

Output Isolation:

Isolated

Voltage - Breakdown:

700V

Voltage - Supply (Vcc/Vdd):

-

Frequency - Switching:

66kHz, 132kHz

Fault Protection:

Current Limiting, Over Temperature, Over Voltage

Operating Temperature:

-40°C ~ 150°C (Tj)

Supplier Device Package:

TO-220-7C

Base Product Number:

TOP256

Manufacturer:

Power Integrations

Product Status:

Active

Internal Switch(s):

Yes

Topology:

Flyback

Duty Cycle:

78%

Power (Watts):

119 W

Control Features:

-

Package / Case:

TO-220-7 Formed Leads, 6 Leads

Mounting Type:

Through Hole

Environmental & Export classification

RoHS Status:

RoHS Compliant

REACH Status:

REACH Unaffected

HTSUS:

8542.39.0001

Moisture Sensitivity Level (MSL):

1 (Unlimited)

ECCN:

EAR99

TOP252-262

TOPSwitch[®]-HX Family

Enhanced EcoSmart[®], Integrated Off-Line Switcher with Advanced Feature Set and Extended Power Range

Product Highlights

Lower System Cost, Higher Design Flexibility

- Multi-mode operation maximizes efficiency at all loads
- New eSIP-7F and eSIP-7C packages
 - Low thermal impedance junction-to-case (2 °C per watt)
 - Low height is ideal for adapters where space is limited
 - Simple mounting using a clip to aid low cost manufacturing
 - Horizontal eSIP-7F package ideal for ultra low height adapter and monitor applications
- Extended package creepage distance from DRAIN pin to adjacent pin and to heat sink
- No heatsink required up to 35 W using P, G and M packages with universal input voltage and up to 48 W at 230 VAC
- Output overvoltage protection (OVP) is user programmable for latching/non-latching shutdown with fast AC reset
 - Allows both primary and secondary sensing
- Line undervoltage (UV) detection prevents turn-off glitches
- Line overvoltage (OV) shutdown extends line surge limit
- Accurate programmable current limit
- Optimized line feed-forward for line ripple rejection
- 132 kHz frequency (254Y-258Y and all E/L packages) reduces transformer and power supply size
 - Half frequency option for video applications
- Frequency jittering reduces EMI filter cost

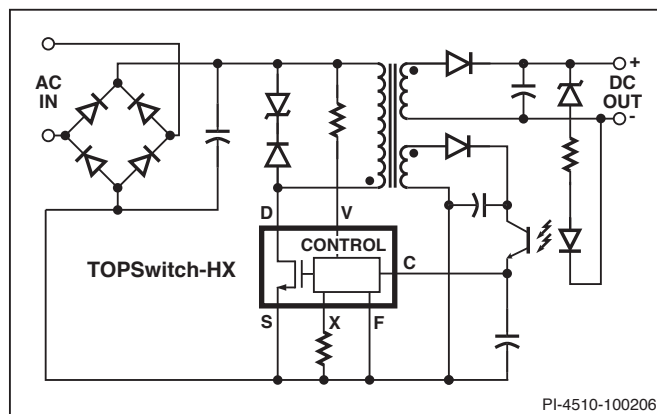

Figure 1. Typical Flyback Application.

- Heatsink is connected to SOURCE for low EMI
- Improved auto-restart delivers <3% of maximum power in short circuit and open loop fault conditions
- Accurate hysteretic thermal shutdown function automatically recovers without requiring a reset
- Fully integrated soft-start for minimum start-up stress
- Extended creepage between DRAIN and all other pins improves field reliability

Output Power Table

Product ⁵	230 VAC ±15% ⁴			85-265 VAC			Product ⁵	230 VAC ±15%		85-265 VAC	
	Adapter ¹	Open Frame ²	Peak ³	Adapter ¹	Open Frame ²	Peak ³		Adapter ¹	Open Frame ²	Adapter ¹	Open Frame ²
TOP252PN/GN	9 W	15 W	21 W	6 W	10 W	13 W	TOP252EN	10 W	21 W	6 W	13 W
TOP252MN			21 W			13 W	TOP253EN	21 W	43 W	13 W	29 W
TOP253PN/GN	15 W	25 W	38 W	9 W	15 W	25 W	TOP254EN/YN	30 W	62 W	20 W	43 W
TOP253MN			43 W			29 W	TOP255EN/YN	40 W	81 W	26 W	57 W
TOP254PN/GN	16 W	28 W	47 W	11 W	20 W	30 W	TOP255LN	40 W	81 W	26 W	57 W
TOP254MN			62 W			40 W	TOP256EN/YN ⁷	60 W	119 W	40 W	86 W
TOP255PN/GN	19 W	30 W	54 W	13 W	22 W	35 W	TOP256LN	60 W	88 W	40 W	64 W
TOP255MN			81 W			52 W	TOP257EN/YN	85 W	157 W	55 W	119 W
TOP256PN/GN	21 W	34 W	63 W	15 W	26 W	40 W	TOP257LN	85 W	105 W	55 W	78 W
TOP256MN			98 W			64 W	TOP258EN/YN	105 W	195 W	70 W	148 W
TOP257PN/GN	25 W	41 W	70 W	19 W	30 W	45 W	TOP258LN	105 W	122 W	70 W	92 W
TOP257MN			119 W			78 W	TOP259EN/YN	128 W	238 W	80 W	171 W
TOP258PN/GN	29 W	48 W	77 W	22 W	35 W	50 W	TOP259LN	128 W	162 W	80 W	120 W
TOP258MN			140 W			92 W	TOP260EN/YN	147 W	275 W	93 W	200 W
							TOP260LN	147 W	190 W	93 W	140 W
							TOP261EN/YN	177 W	333 W	118 W	254 W
							TOP261LN	177 W	244 W	118 W	177 W
							TOP262EN ⁶	177 W	333 W	118 W	254 W
							TOP262LN ⁶	177 W	244 W	118 W	177 W

Table 1. Output Power Table. (for notes see page 2).

TOP252-262

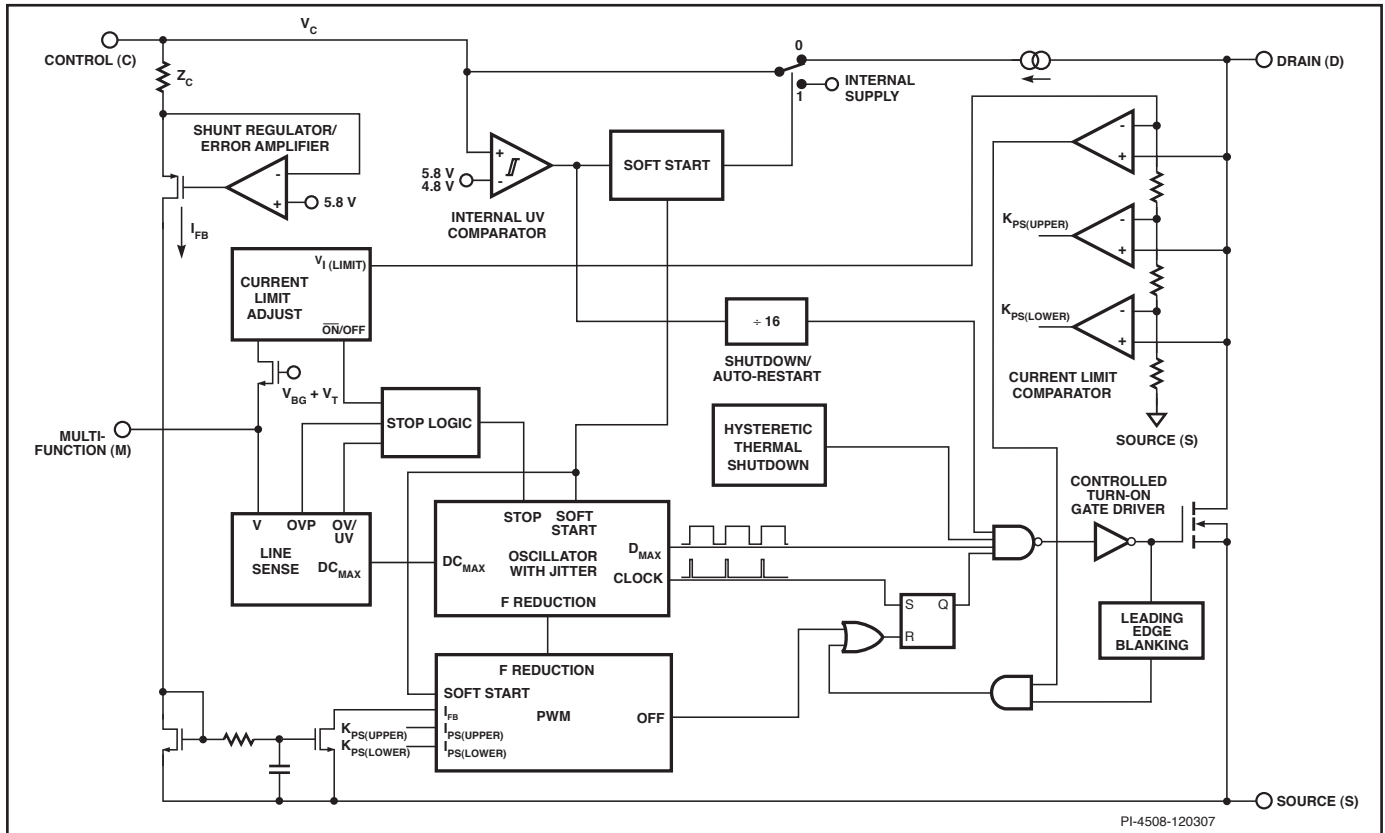

Figure 3a. Functional Block Diagram (P and G Packages).

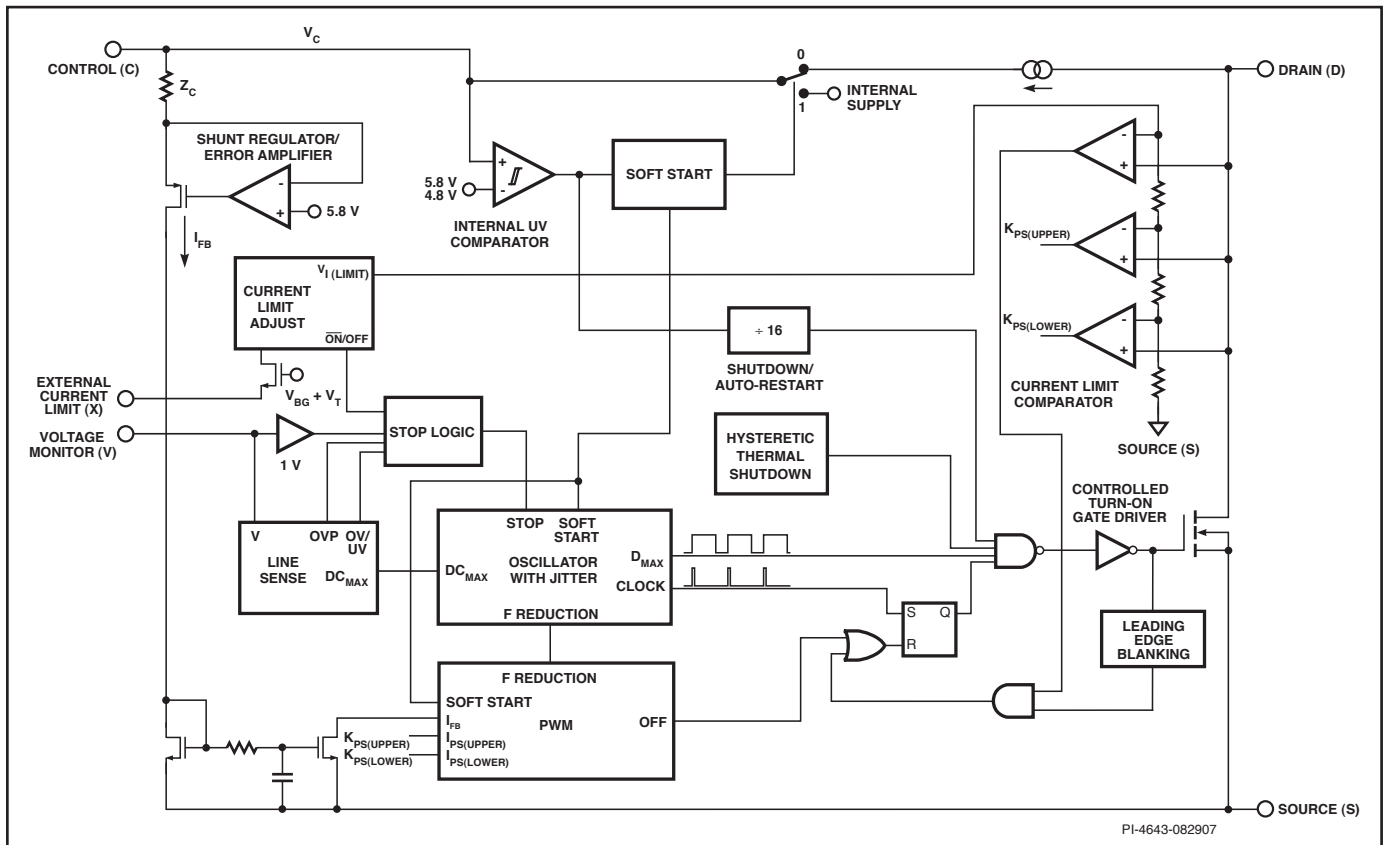

Figure 3b. Functional Block Diagram (M Package).

TOP252-262

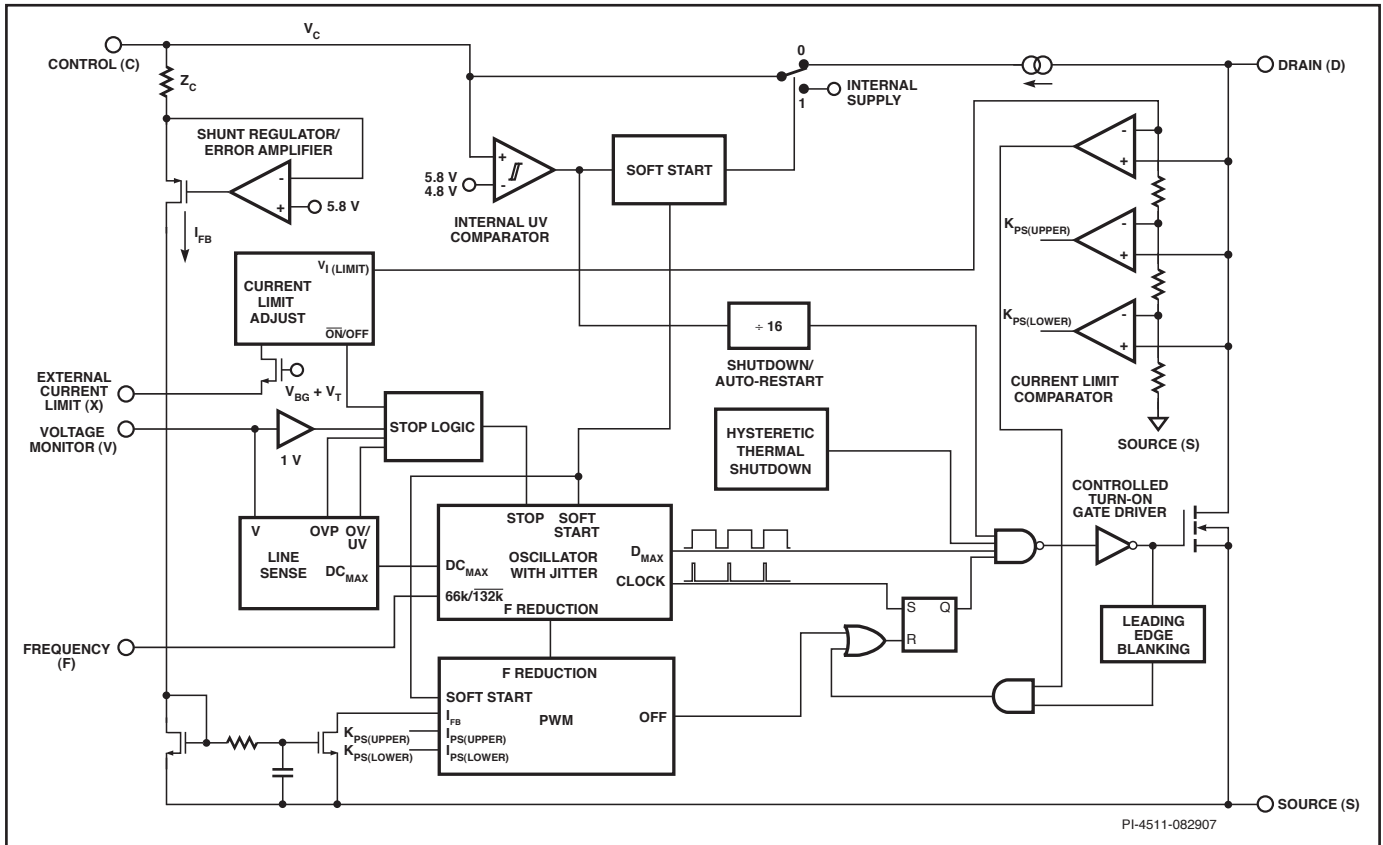

Figure 3c. Functional Block Diagram (TOP254-258 YN Package and all eSIP Packages).

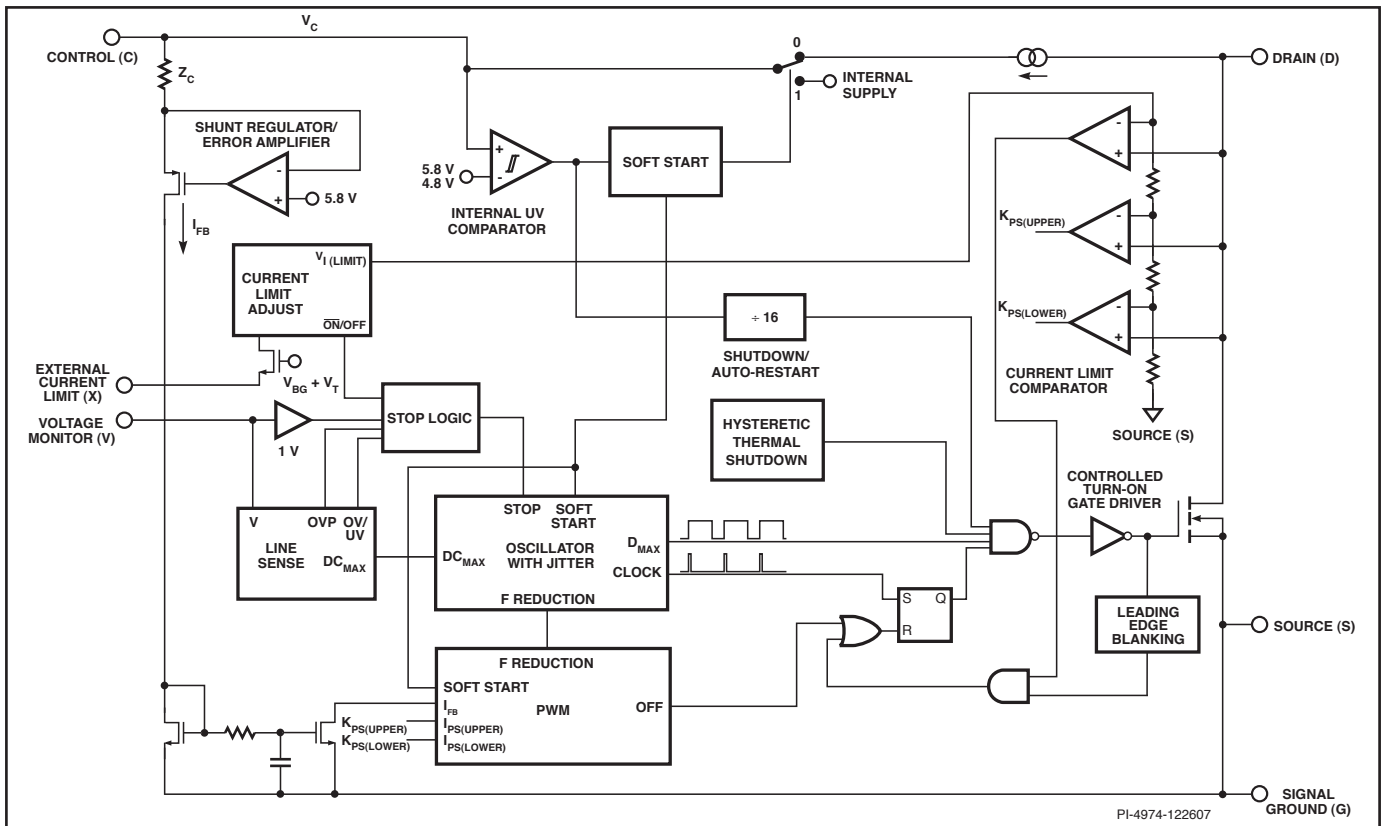

Figure 3d. Functional Block Diagram TOP259YN, TOP260YN, TOP261YN.

TOP252-262

Pin Functional Description

DRAIN (D) Pin:

High-voltage power MOSFET DRAIN pin. The internal start-up bias current is drawn from this pin through a switched high-voltage current source. Internal current limit sense point for drain current.

CONTROL (C) Pin:

Error amplifier and feedback current input pin for duty cycle control. Internal shunt regulator connection to provide internal bias current during normal operation. It is also used as the connection point for the supply bypass and auto-restart/compensation capacitor.

EXTERNAL CURRENT LIMIT (X) Pin (Y, M, E and L package):

Input pin for external current limit adjustment and remote ON/OFF. A connection to SOURCE pin disables all functions on this pin.

VOLTAGE MONITOR (V) Pin (Y & M package only):

Input for OV, UV, line feed forward with DC_{MAX} reduction, output overvoltage protection (OVP), remote ON/OFF and device reset. A connection to the SOURCE pin disables all functions on this pin.

MULTI-FUNCTION (M) Pin (P & G packages only):

This pin combines the functions of the VOLTAGE MONITOR (V) and EXTERNAL CURRENT LIMIT (X) pins of the Y package into one pin. Input pin for OV, UV, line feed forward with DC_{MAX}

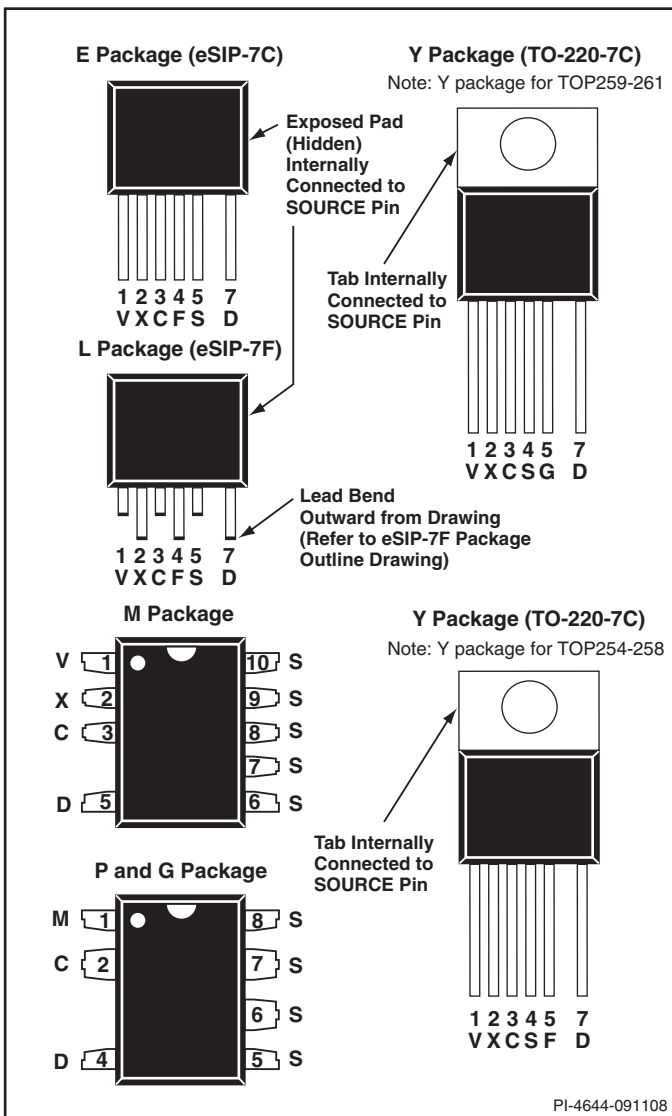

Figure 4. Pin Configuration (Top View).

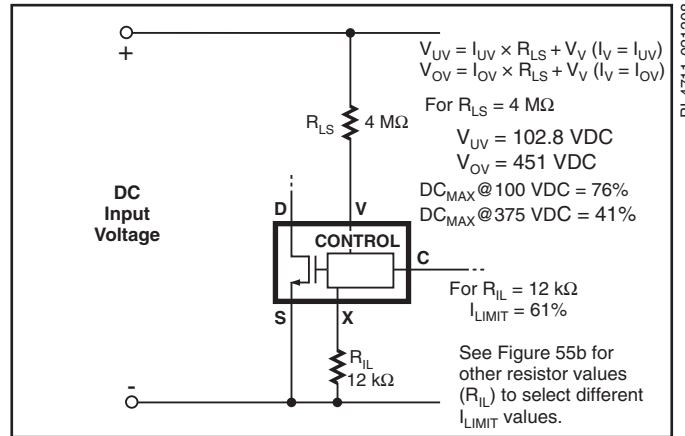

Figure 5. TOP254-258 Y and All M/E/L Package Line Sense and Externally Set Current Limit.

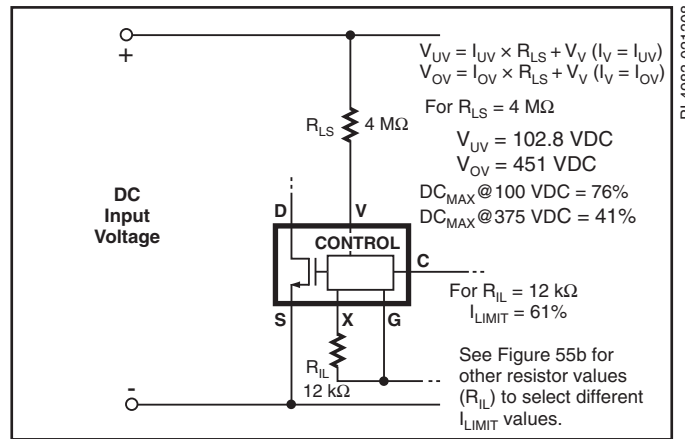

Figure 6. TOP259-261 Y Package Line Sense and External Current Limit.

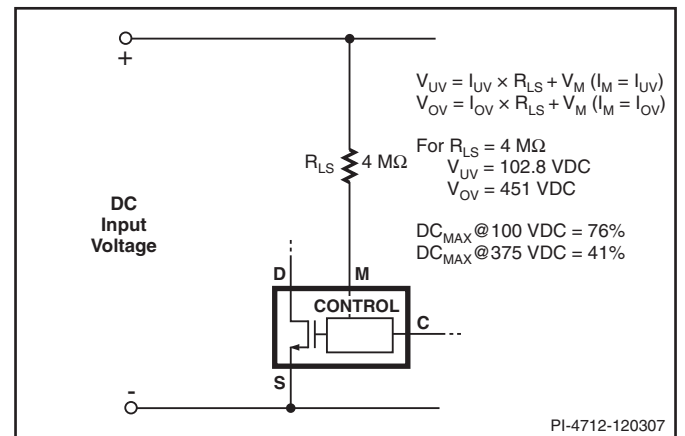

Figure 7. P/G Package Line Sense.

OUR CERTIFICATE

DiGi provide top-quality products and perfect service for customer worldwide through standardization, technological innovation and continuous improvement. DiGi through third-party certification, we strictly control the quality of products and services. Welcome your RFQ to

Email: Info@DiGi-Electronics.com



Tel: +00 852-30501935

RFQ Email: Info@DiGi-Electronics.com

DiGi is a global authorized distributor of electronic components.