

# BWCS00231715R68G00 Datasheet

[www.digi-electronics.com](http://www.digi-electronics.com)



<https://www.DiGi-Electronics.com>

DiGi Electronics Part Number	BWCS00231715R68G00-DG
Manufacturer	<a href="#">Pulse Electronics</a>
Manufacturer Product Number	BWCS00231715R68G00
Description	FIXED IND 680NH 190MA 2.2OHM SMD
Detailed Description	680 nH Unshielded Drum Core, Wirewound Inductor 190 mA 2.2Ohm Max Nonstandard



Tel: +00 852-30501935

RFQ Email: [Info@DiGi-Electronics.com](mailto:Info@DiGi-Electronics.com)

DiGi is a global authorized distributor of electronic components.



## Purchase and inquiry

**Manufacturer Product Number:**

BWCS00231715R68G00

**Series:**

BWCS

**Type:**

Drum Core, Wirewound

**Inductance:**

680 nH

**Current Rating (Amps):**

190 mA

**Shielding:**

Unshielded

**Q @ Freq:**

23 @ 50MHz

**Ratings:**

-

**Inductance Frequency - Test:**

25 MHz

**Mounting Type:**

Surface Mount

**Supplier Device Package:**

0907

**Height - Seated (Max):**

0.060" (1.52mm)

**Manufacturer:**

Pulse Electronics

**Product Status:**

Active

**Material - Core:**

Ceramic

**Tolerance:**

±2%

**Current - Saturation (Isat):**

-

**DC Resistance (DCR):**

2.2Ohm Max

**Frequency - Self Resonant:**

188MHz

**Operating Temperature:**

-40°C ~ 125°C

**Features:**

-

**Package / Case:**

Nonstandard

**Size / Dimension:**

0.093" L x 0.068" W (2.35mm x 1.73mm)

## Environmental & Export classification

**RoHS Status:**

ROHS3 Compliant

**REACH Status:**

REACH Unaffected

**HTSUS:**

8504.50.8000

**Moisture Sensitivity Level (MSL):**

1 (Unlimited)

**ECCN:**

EAR99

# SMD Wire Wound Ceramic Chip Inductors - BWCS Series

## BWCS Series



Due to accurate wire winding technology, these chip inductors are designed for filtering, impedance matching, resonance and choke circuits for RF designer. Both standard series custom designs are available.

### Features

- RoHS Compliant
- Ceramic body and wire wound construction provide high SRFs
- Exceptional Q values even at high frequencies
- Highest possible SRFs as well as excellent Q values
- The non-magnetic coil form assures utmost thermal stability, predictability and batch consistency
- CS series is standard for RF designers

### Applications

- RF products for cellular phone
- GPS receiver
- Base Station
- Repeater
- Wireless LAN/ mouse/ keyboard/ earphone
- Remote control
- Security system and other RF modules

### Product Identification

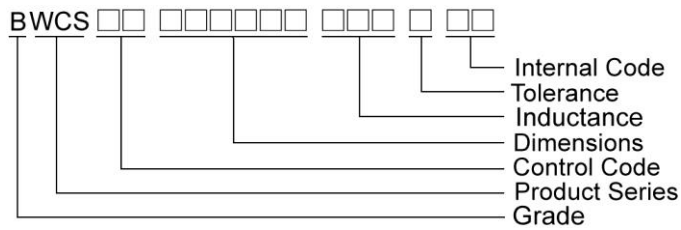

### Shape and Dimensions / Recommended Pattern

**BWCS00060404**

**BWCS00120707**

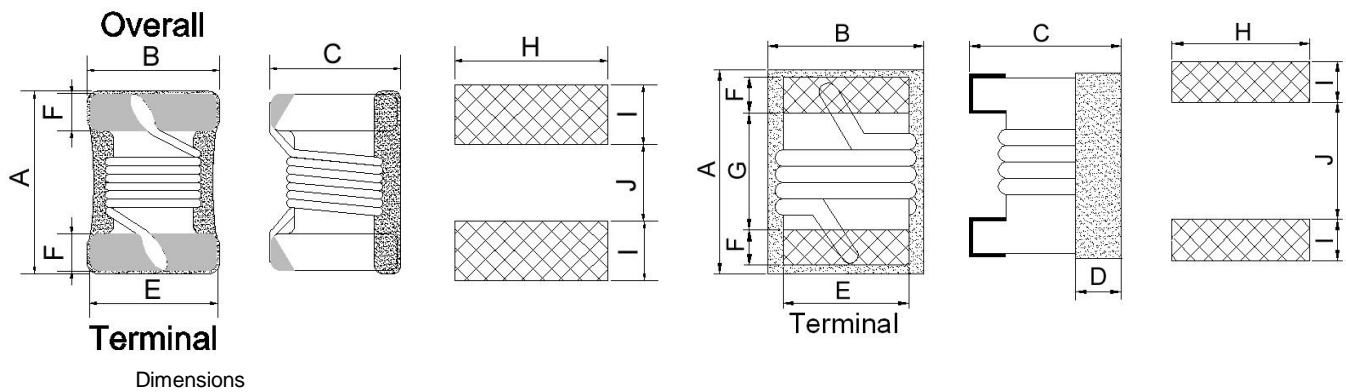

		A Max	B Max	C Max	D	E	F	G	H	I	J
<b>BWCS00060404</b>	inch	0.023	0.018	0.018	-	0.015	0.004	-	0.018	0.007	0.009
	mm	0.58	0.46	0.45	-	0.38	0.1	-	0.46	0.18	0.23
<b>BWCS00120707</b>	inch	0.047	0.025	0.026	0.010	0.020	0.009	0.022	0.026	0.014	0.018
	mm	1.19	0.64	0.66	0.25	0.51	0.23	0.56	0.66	0.36	0.46

## SMD Wire Wound Ceramic Chip Inductors - BWCS Series

**BWCS00161008/ 231715/ 292821**

**BWCS00493834**

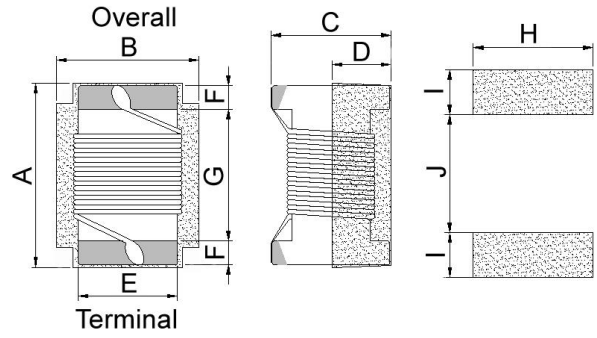
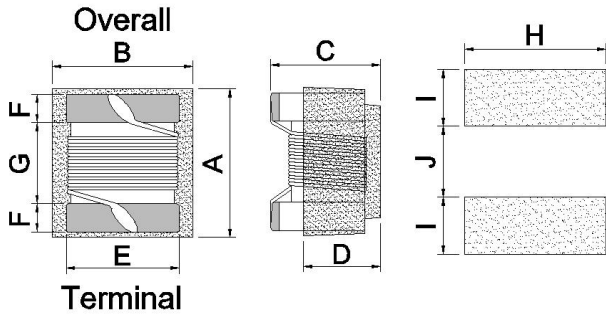

Dimensions

		A	B	C	D	E	F	G	H	I	J
<b>BWCS00161008</b>	mm	1.6 <sup>+0.2</sup> <sub>-0.1</sub>	1.02±0.1	0.82 <sup>+0.2</sup> <sub>-0.1</sub>	0.51	0.76	0.33	0.86	1.02	0.64	0.64
		A Max	B Max	C Max	D	E	F	G	H	I	J
<b>BWCS00231715</b>	inch	0.093	0.068	0.06	0.028	0.050	0.020	0.040	0.070	0.040	0.030
	mm	2.35	1.73	1.52	0.71	1.27	0.51	1.02	1.78	1.02	0.76
<b>BWCS00292821</b>	inch	0.115	0.110	0.083	0.046	0.080	0.020	0.060	0.100	0.040	0.050
	mm	2.92	2.79	2.1	1.16	2.03	0.51	1.52	2.54	1.02	1.27
<b>BWCS00493834</b>	inch	0.197	0.154	0.135	0.07	0.1	0.025	0.128	0.12	0.045	0.118
	mm	4.95	3.81	3.43	1.78	2.54	0.64	3.25	3.05	1.14	3.00

**SMD Wire Wound Ceramic Chip Inductors - BWCS Series****Electrical Characteristics**

Part Number	Inductance (nH)	Tolerance (±%)	Test Frequency (MHz)	Q Min	SRF (GHz) Typ	RDC (Ω) Max	Irms (mA) Typ
BWCS000604040N5□00	0.5	10	250	4	23.5	0.02	1250
BWCS000604040N6□00	0.6	10	250	6	24.5	0.03	1000
BWCS000604041N2□00	1.2	5	250	13	17.9	0.042	870
BWCS000604041N3□00	1.3	5	250	11	17.6	0.048	820
BWCS000604041N4□00	1.4	5	250	14	17	0.08	630
BWCS000604041N5□00	1.5	5	250	11	17	0.09	600
BWCS000604042N2□00	2.2	5	250	15	16.7	0.07	700
BWCS000604042N3□00	2.3	5	250	18	16.5	0.07	670
BWCS000604042N4□00	2.4	5	250	13	13	0.082	620
BWCS000604042N5□00	2.5	5	250	16	12.5	0.165	440
BWCS000604043N3□00	3.3	5	250	14	12.8	0.08	630
BWCS000604043N4□00	3.4	5	250	11	12.7	0.08	630
BWCS000604043N5□00	3.5	5	250	16	12.4	0.08	630
BWCS000604043N6□00	3.6	5	250	18	12.5	0.105	550
BWCS000604043N7□00	3.7	5	250	15	10.6	0.105	550
BWCS000604043N8□00	3.8	5	250	16	10.2	0.18	420
BWCS000604043N9□00	3.9	5	250	12	11.2	0.24	360
BWCS000604044N8□00	4.8	5	250	17	11	0.096	570
BWCS000604044N9□00	4.9	5	250	18	11.7	0.13	510
BWCS000604045N0□00	5.0	5	250	18	11.5	0.13	510
BWCS000604045N1□00	5.1	5	250	18	11.1	0.13	510
BWCS000604045N2□00	5.2	5	250	18	10	0.17	430
BWCS000604045N3□00	5.3	5	250	18	10.6	0.13	510
BWCS000604045N4□00	5.4	5	250	18	10.2	0.13	510
BWCS000604045N5□00	5.5	5	250	16	9.5	0.285	330
BWCS000604046N7□00	6.7	5	250	18	6.8	0.15	460
BWCS000604046N8□00	6.8	5	250	18	9.5	0.15	460
BWCS000604046N9□00	6.9	5	250	18	9.3	0.15	460
BWCS000604047N0□00	7.0	5	250	18	6.7	0.21	390
BWCS000604047N1□00	7.1	5	250	18	9.5	0.25	390
BWCS000604047N2□00	7.2	5	250	18	9.4	0.25	390
BWCS000604047N3□00	7.3	5	250	18	9.3	0.25	390

**Note: When ordering, please specify tolerance code. Tolerance : J=±5% , K=±10%**

- Operating temperature range—40°C ~ 125°C (Including self - temperature rise)
- Irms for a 15°C temperature rise from 25°C ambient with current
- Measure Equipment :  
L & Q : HP4286A/HP4287A/AgilentE4991/Keysight E4982A  
SRF : Agilent HP8753D/Agilent HP8722ES  
RDC : HP4287A  
Irms : HP4284A+HP42841A/HP4285A+HP42841A

Please be sure to request approval specifications that provide further details of the products. Kindly note that the content of these specifications are subject to change or may be discontinued without prior notice. This product may not be designed/used in medical or high risk applications without Chilisin approval. Please contact our sales department before ordering.

# SMD Wire Wound Ceramic Chip Inductors - BWCS Series

## Electrical Characteristics

Part Number	Inductance (nH)	Tolerance (±%)	Test Frequency (MHz)	Q Min	SRF (GHz) Typ	RDC (Ω) Max	Irms (mA) Typ
BWCS000604047N4□00	7.4	5	250	18	9.1	0.25	390
BWCS000604047N5□00	7.5	5	250	15	6.8	0.34	300
BWCS000604047N6□00	7.6	5	250	17	9.3	0.3	340
BWCS000604047N7□00	7.7	5	250	17	9.2	0.3	340
BWCS000604047N8□00	7.8	5	250	17	9.2	0.3	340
BWCS000604047N9□00	7.9	5	250	17	9.1	0.3	340
BWCS000604048N0□00	8.0	5	250	17	9.2	0.3	340
BWCS000604048N1□00	8.1	5	250	17	9.1	0.3	340
BWCS000604048N2□00	8.2	5	250	17	6.4	0.27	340
BWCS000604048N4□00	8.4	5	250	15	8.9	0.38	300
BWCS000604048N5□00	8.5	5	250	15	8.9	0.38	300
BWCS000604048N7□00	8.7	5	250	15	6.3	0.38	300
BWCS000604049N0□00	9.0	5	250	15	6.4	0.38	300
BWCS000604049N4□00	9.4	5	250	16	6.4	0.4	280
BWCS000604049N6□00	9.6	5	250	16	6.2	0.4	280
BWCS0006040411N□00	11	5	250	16	5.7	0.44	280
BWCS0006040412N□00	12	5	250	17	5.6	0.36	300
BWCS0006040413N□00	13	5	250	16	6.7	0.5	270
BWCS0006040414N□00	14	5	250	16	5.1	0.5	270

**Note:** When ordering, please specify tolerance code. Tolerance : J=±5% , K=±10%

- Operating temperature range – 40°C ~ 125°C (Including self - temperature rise)
- I<sub>rms</sub> for a 15°C temperature rise from 25°C ambient with current
- Measure Equipment :  
 L & Q : HP4286A/HP4287A/AgilentE4991/Keysight E4982A  
 SRF : Agilent HP8753D/Agilent HP8722ES  
 RDC : HP4287A  
 I<sub>rms</sub> : HP4284A+HP42841A/HP4285A+HP42841A

Typical L vs. Frequency

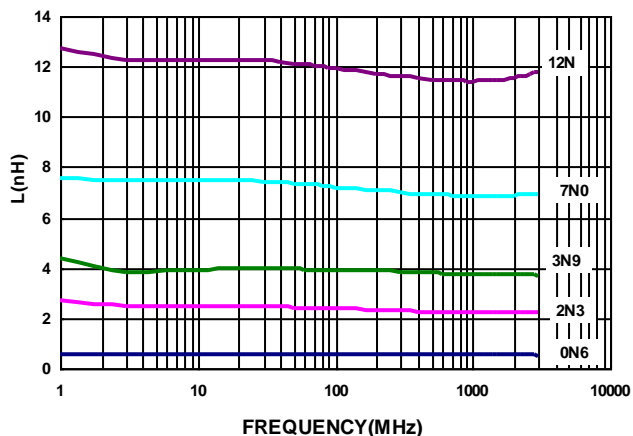

Typical Q vs. Frequency

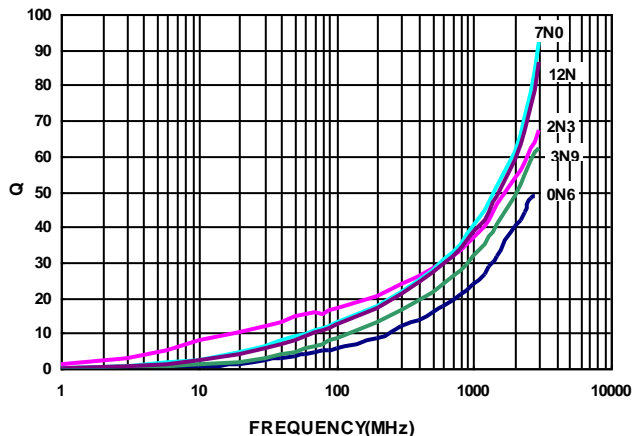

Please be sure to request approval specifications that provide further details of the products. Kindly note that the content of these specifications are subject to change or may be discontinued without prior notice. This product may not be designed/used in medical or high risk applications without Chilisin approval. Please contact our sales department before ordering.



**SMD Wire Wound Ceramic Chip Inductors - BWCS Series****Electrical Characteristics**

Part Number	Inductance (nH)	Tolerance (±%)	Test Frequency (MHz)	Q Min	SRF (GHz) Min	RDC (Ω) Max	Irms (mA) Max
BWCS001207071N0□00	1.0	10 / 5 / ±0.1nH	250	16	12.7	0.045	1360
BWCS001207071N2□00	1.2	10 / 5 / ±0.1nH	250	10	10.4	0.140	640
BWCS001207071N3□00	1.3	10 / ±0.1nH	250	10	10.4	0.140	640
BWCS001207071N9□00	1.9	10 / 5 / ±0.1nH	250	16	11.3	0.070	1040
BWCS001207072N0□00	2.0	10 / 5 / ±0.1nH	250	16	11.1	0.070	1040
BWCS001207072N2□00	2.2	10 / 5 / ±0.1nH	250	19	10.8	0.070	960
BWCS001207072N4□00	2.4	10 / 5 / ±0.1nH	250	15	10.5	0.068	790
BWCS001207072N5□00	2.5	10 / 5 / ±0.1nH	250	13	10.4	0.150	640
BWCS001207072N7□00	2.7	10 / 5 / ±0.1nH	250	16	10.4	0.120	640
BWCS001207073N3□00	3.3	10 / 5 / 3	250	19	7.00	0.066	840
BWCS001207073N6□00	3.6	10 / 5 / 3	250	19	6.80	0.066	840
BWCS001207073N9□00	3.9	10 / 5 / 3	250	19	6.00	0.066	840
BWCS001207074N3□00	4.3	10 / 5 / 3	250	18	6.00	0.091	700
BWCS001207074N7□00	4.7	10 / 5 / 3	250	15	4.77	0.130	640
BWCS001207075N1□00	5.1	10 / 5 / 3	250	20	4.80	0.083	800
BWCS001207075N6□00	5.6	10 / 5 / 3	250	20	4.80	0.083	760
BWCS001207075N8□00	5.8	10 / 5 / 3	250	20	4.80	0.083	760
BWCS001207076N2□00	6.2	10 / 5 / 3	250	20	4.80	0.083	760
BWCS001207076N8□00	6.8	10 / 5 / 3	250	20	4.80	0.083	680
BWCS001207077N3□00	7.3	10 / 5 / 3	250	20	4.80	0.12	680
BWCS001207077N5□00	7.5	10 / 5 / 3	250	22	4.80	0.10	680
BWCS001207078N2□00	8.2	10 / 5 / 3	250	22	4.40	0.10	680
BWCS001207078N7□00	8.7	10 / 5 / 3	250	18	4.10	0.20	480
BWCS001207079N0□00	9.0	10 / 5 / 3	250	22	4.16	0.10	680
BWCS001207079N1□00	9.1	10 / 5 / 3	250	22	4.16	0.10	680
BWCS001207079N5□00	9.5	10 / 5 / 3	250	18	4.00	0.20	480
BWCS0012070710N□00	10	10 / 5 / 3 / 2	250	21	3.90	0.20	480
BWCS0012070711N□00	11	10 / 5 / 3 / 2	250	24	3.68	0.12	640
BWCS0012070712N□00	12	10 / 5 / 3 / 2	250	24	3.60	0.12	640
BWCS0012070713N□00	13	10 / 5 / 3 / 2	250	24	3.45	0.21	440
BWCS0012070715N□00	15	10 / 5 / 3 / 2	250	24	3.28	0.17	560
BWCS0012070716N□00	16	10 / 5 / 3 / 2	250	24	3.10	0.22	560

**Note: When ordering, please specify tolerance code. Tolerance : B=±0.1nH , G=±2% , H=±3% , J=±5% , K=±10%**

- Operating temperature range – 40°C ~ 125°C (Including self - temperature rise)
- I<sub>rms</sub> for a 15°C temperature rise from 25°C ambient with current
- Measure Equipment :
  - L & Q : Agilent E4991A+Agilent HP16197A
  - SRF : Agilent HP8753D/Agilent HP8722ES
  - RDC : HP4287A
  - I<sub>rms</sub> : HP4284A+HP42841A/HP4285A+HP42841A

## SMD Wire Wound Ceramic Chip Inductors – BWCS Series

### Electrical Characteristics

Part Number	Inductance (nH)	Tolerance (±%)	Test Frequency (MHz)	Q Min	SRF (GHz) Min	RDC (Ω) Max	Irms (mA) Max
BWCS0012070718N□00	18	10 / 5 / 3 / 2	250	25	3.10	0.23	420
BWCS0012070719N□00	19	10 / 5 / 3 / 2	250	24	3.04	0.20	480
BWCS0012070720N□00	20	10 / 5 / 3 / 2	250	25	3.00	0.25	420
BWCS0012070722N□00	22	10 / 5 / 3 / 2	250	25	2.80	0.30	400
BWCS0012070723N□00	23	10 / 5 / 3 / 2	250	22	2.72	0.30	400
BWCS0012070724N□00	24	10 / 5 / 3 / 2	250	25	2.70	0.30	400
BWCS0012070727N□00	27	10 / 5 / 3 / 2	250	24	2.48	0.30	400
BWCS0012070730N□00	30	10 / 5 / 3 / 2	250	25	2.35	0.35	400
BWCS0012070733N□00	33	10 / 5 / 3 / 2	250	24	2.35	0.40	400
BWCS0012070736N□00	36	10 / 5 / 3 / 2	250	24	2.32	0.44	320
BWCS0012070739N□00	39	10 / 5 / 3 / 2	250	25	2.10	0.55	200
BWCS0012070740N□00	40	10 / 5 / 3 / 2	250	24	2.24	0.65	320
BWCS0012070743N□00	43	10 / 5 / 3 / 2	250	25	2.03	0.81	100
BWCS0012070747N□00	47	10 / 5 / 3 / 2	250	20	2.10	0.83	150
BWCS0012070751N□00	51	10 / 5 / 3 / 2	250	25	1.75	0.82	100
BWCS0012070756N□00	56	10 / 5 / 3 / 2	250	22	1.76	0.97	100
BWCS0012070768N□00	68	10 / 5 / 3 / 2	250	22	1.62	1.12	100
BWCS0012070782N□00	82	10 / 5 / 3 / 2	250	20	1.26	1.55	50
BWCS00120707R10□00	100	10 / 5 / 3 / 2	250	20	1.16	2.00	30
BWCS00120707R18□00	180	10 / 5 / 3 / 2	100	8	0.70	2.70	50
BWCS00120707R22□00	220	10 / 5 / 3 / 2	100	8	0.70	4.00	50

**Note:** When ordering, please specify tolerance code. Tolerance : B=±0.1nH , G=±2% , H=±3% , J=±5% , K=±10%

- Operating temperature range – 40°C ~ 125°C (Including self - temperature rise)
- Irms for a 15°C temperature rise from 25°C ambient with current
- Measure Equipment :  
 L & Q : Agilent E4991A+Agilent HP16197A  
 SRF : Agilent HP8753D/Agilent HP8722ES  
 RDC : HP4287A  
 Irms : HP4284A+HP42841A/HP4285A+HP42841A

Typical **L** vs. **F** Frequency

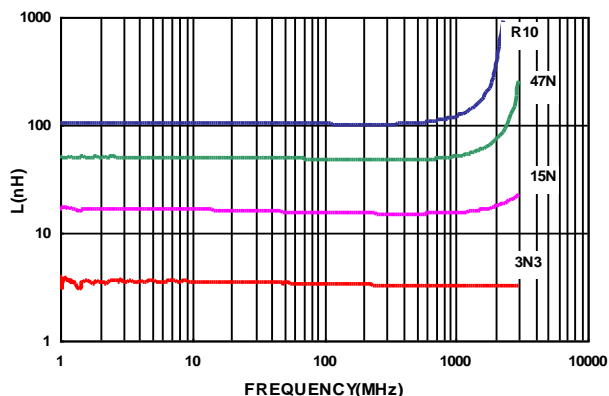

Typical **Q** vs. **F** Frequency

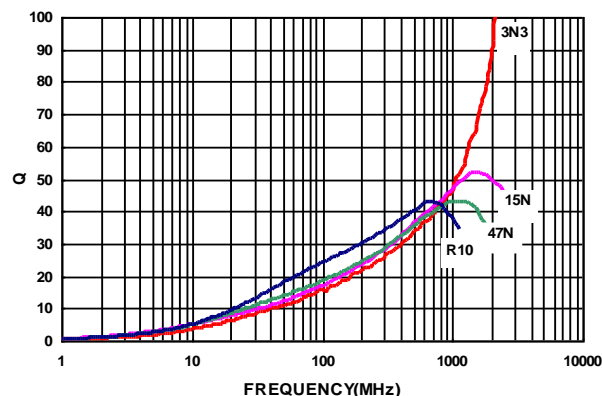

Please be sure to request approval specifications that provide further details of the products. Kindly note that the content of these specifications are subject to change or may be discontinued without prior notice. This product may not be designed/used in medical or high risk applications without Chilisin approval. Please contact our sales department before ordering.



**SMD Wire Wound Ceramic Chip Inductors – BWCS Series****Electrical Characteristics**

Part Number	Inductance (nH)	Tolerance (±%)	Test Frequency (MHz)	Q Min	SRF (MHz) Min	RDC (Ω) Max	I <sub>rms</sub> (mA) Max	Color
BWCS001610081N6□00	1.6	10 / 5 / ±0.1nH	250	24	12500	0.030	700	Red
BWCS001610081N8□00	1.8	10 / 5 / ±0.1nH	250	16	12500	0.045	700	Black
BWCS001610082N2□00	2.2	10 / 5 / ±0.1nH	250	13	12500	0.250	700	Yellow
BWCS001610083N3□00	3.3	10 / 5 / 3 / 2	250	35	5900	0.045	700	Blue
BWCS001610083N6□00	3.6	10 / 5 / 3 / 2	250	22	5900	0.063	700	Red
BWCS001610083N9□00	3.9	10 / 5 / 3 / 2	250	22	6900	0.080	700	Brown
BWCS001610084N3□00	4.3	10 / 5 / 3 / 2	250	22	5900	0.063	700	Orange
BWCS001610084N7□00	4.7	10 / 5 / 3 / 2	250	20	5800	0.116	700	Violet
BWCS001610085N1□00	5.1	10 / 5 / 3 / 2	250	20	5700	0.140	700	Green
BWCS001610085N6□00	5.6	10 / 5 / 3 / 2	250	20	5800	0.170	700	Yellow
BWCS001610086N3□00	6.3	10 / 5 / 3 / 2	250	20	5700	0.140	700	White
BWCS001610086N8□00	6.8	10 / 5 / 3 / 2	250	27	5800	0.110	700	Red
BWCS001610087N5□00	7.5	10 / 5 / 3 / 2	250	28	4800	0.106	700	Brown
BWCS001610088N2□00	8.2	10 / 5 / 3 / 2	250	28	4700	0.109	700	White
BWCS001610088N7□00	8.7	10 / 5 / 3 / 2	250	28	4600	0.109	700	Yellow
BWCS001610089N1□00	9.1	10 / 5 / 3 / 2	250	28	4800	0.120	700	Violet
BWCS001610089N5□00	9.5	10 / 5 / 3 / 2	250	28	5400	0.135	700	Blue
BWCS0016100810N□00	10	10 / 5 / 3 / 2	250	31	4800	0.130	700	Orange
BWCS0016100811N□00	11	10 / 5 / 3 / 2	250	33	4000	0.086	700	Gray
BWCS0016100812N□00	12	10 / 5 / 3 / 2	250	35	4000	0.130	700	Yellow
BWCS0016100813N□00	13	10 / 5 / 3 / 2	250	30	4000	0.160	700	Black
BWCS0016100815N□00	15	10 / 5 / 3 / 2	250	35	4000	0.170	700	Green
BWCS0016100816N□00	16	10 / 5 / 3 / 2	250	34	3300	0.104	700	White
BWCS0016100818N□00	18	10 / 5 / 3 / 2	250	35	3100	0.170	700	Blue
BWCS0016100820N□00	20	10 / 5 / 3 / 2	250	38	3000	0.190	700	Red
BWCS0016100822N□00	22	10 / 5 / 3 / 2	250	38	3000	0.190	700	Violet
BWCS0016100823N□00	23	10 / 5 / 3 / 2	250	38	2850	0.190	700	Orange
BWCS0016100824N□00	24	10 / 5 / 3 / 2	250	37	2650	0.135	700	Black
BWCS0016100827N□00	27	10 / 5 / 3 / 2	250	40	2800	0.220	600	Gray
BWCS0016100830N□00	30	10 / 5 / 3 / 2	250	37	2250	0.144	600	Brown
BWCS0016100833N□00	33	10 / 5 / 3 / 2	250	40	2300	0.220	600	White
BWCS0016100836N□00	36	10 / 5 / 3 / 2	250	38	2080	0.250	600	Red
BWCS0016100839N□00	39	10 / 5 / 3 / 2	250	40	2200	0.250	600	Black
BWCS0016100843N□00	43	10 / 5 / 3 / 2	250	39	2000	0.280	600	Orange

**Note: When ordering, please specify tolerance code. Tolerance : B=±0.1nH , G=±2% , H=±3% , J=±5% , K=±10%**

- Operating temperature range – 40°C ~ 125°C (Including self - temperature rise)
- I<sub>rms</sub> for a 15°C temperature rise from 25°C ambient with current
- Measure Equipment :  
L & Q : Agilent E4991A+Agilent HP16197A  
SRF : Agilent HP8753D/Agilent E4991A  
RDC : Chroma 16502  
I<sub>rms</sub> : HP4284A+HP42841A/HP4285A+HP42841A

Please be sure to request approval specifications that provide further details of the products. Kindly note that the content of these specifications are subject to change or may be discontinued without prior notice. This product may not be designed/used in medical or high risk applications without Chilisin approval. Please contact our sales department before ordering.

## SMD Wire Wound Ceramic Chip Inductors – BWCS Series

### Electrical Characteristics

Part Number	Inductance (nH)	Tolerance (±%)	Test Frequency (MHz)	Q Min	SRF (MHz) Min	RDC (Ω) Max	Irms (mA) Max	Color
BWCS0016100847N□00	47	10 / 5 / 3 / 2	200	38	2000	0.280	600	Brown
BWCS0016100851N□00	51	10 / 5 / 3 / 2	200	38	1900	0.310	600	Brown
BWCS0016100856N□00	56	10 / 5 / 3 / 2	200	38	1900	0.310	600	Red
BWCS0016100868N□00	68	10 / 5 / 3 / 2	200	37	1700	0.340	600	Orange
BWCS0016100872N□00	72	10 / 5 / 3 / 2	150	34	1700	0.490	400	Yellow
BWCS0016100882N□00	82	10 / 5 / 3 / 2	150	34	1700	0.540	400	Green
BWCS0016100891N□00	91	10 / 5 / 3 / 2	150	34	1400	0.580	400	Black
BWCS00161008R10□00	100	10 / 5 / 3 / 2	150	34	1400	0.580	400	Blue
BWCS00161008R11□00	110	10 / 5 / 3 / 2	150	32	1350	0.610	300	Violet
BWCS00161008R12□00	120	10 / 5 / 3 / 2	150	32	1300	0.750	300	Gray
BWCS00161008R15□00	150	10 / 5 / 3 / 2	150	28	990	0.920	280	White
BWCS00161008R16□00	160	10 / 5 / 3 / 2	100	25	990	1.250	240	Yellow
BWCS00161008R18□00	180	10 / 5 / 3 / 2	100	25	990	1.250	240	Black
BWCS00161008R20□00	200	10 / 5 / 3 / 2	100	25	900	2.100	200	Red
BWCS00161008R21□00	210	10 / 5 / 3 / 2	100	27	895	2.060	200	Gray
BWCS00161008R22□00	220	10 / 5 / 3 / 2	100	25	900	2.100	200	Brown
BWCS00161008R24□00	240	10 / 5 / 3 / 2	100	25	900	2.200	200	Green
BWCS00161008R25□00	250	10 / 5 / 3 / 2	100	25	822	3.550	120	Violet
BWCS00161008R27□00	270	10 / 5 / 3 / 2	100	24	900	2.800	170	Red
BWCS00161008R33□00	330	10 / 5 / 3 / 2	100	25	900	3.890	100	Orange
BWCS00161008R39□00	390	10 / 5 / 3 / 2	100	25	900	4.350	100	Yellow
BWCS00161008R47□00	470	10 / 5 / 3 / 2	100	25	500	4.500	100	Brown
BWCS00161008R56□00	560	10 / 5 / 3 / 2	100	23	460	4.700	90	Blue

**Note: When ordering, please specify tolerance code. Tolerance : B=±0.1nH , G=±2% , H=±3% , J=±5% , K=±10%**

- Operating temperature range – 40°C ~ 125°C (Including self - temperature rise)
- Irms for a 15°C temperature rise from 25°C ambient with current
- Measure Equipment :

L & Q : Agilent E4991A+Agilent HP16197A

SRF : Agilent HP8753D/Agilent E4991A

RDC : Chroma 16502

Irms : HP4284A+HP42841A/HP4285A+HP42841A

**Typical L vs. Frequency**

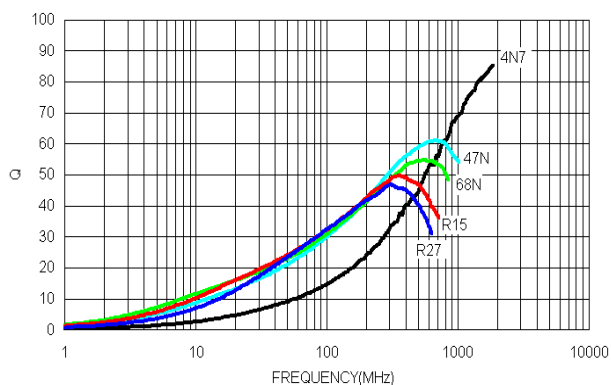

**Typical Q vs. Frequency**

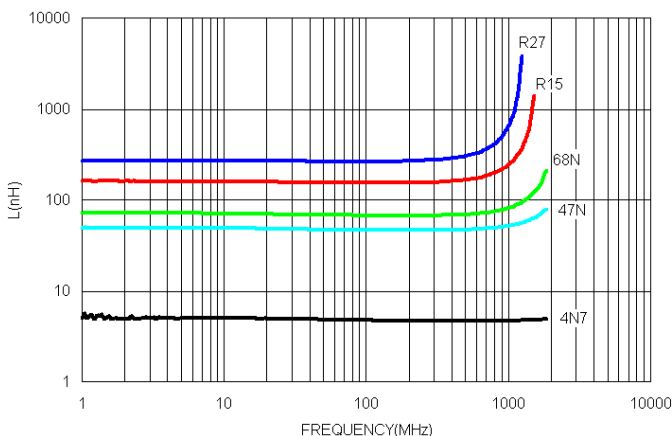

Please be sure to request approval specifications that provide further details of the products. Kindly note that the content of these specifications are subject to change or may be discontinued without prior notice. This product may not be designed/used in medical or high risk applications without Chilisin approval. Please contact our sales department before ordering.

**SMD Wire Wound Ceramic Chip Inductors – BWCS Series****Electrical Characteristics**

Part Number	Inductance (nH)	Tolerance (±%)	Test Frequency (MHz)	Q Min	Test Frequency (MHz)	SRF (MHz) Min	RDC (Ω) Max	Irms (mA) Max	Color
BWCS002317152N7□00	2.7	10 / 5 / 2	250	50	1500	7900	0.06	800	Yellow
BWCS002317152N8□00	2.8	10 / 5 / 2	250	80	1500	7900	0.06	800	Gray
BWCS002317153N0□00	3.0	10 / 5 / 2	250	65	1500	7900	0.06	800	White
BWCS002317153N3□00	3.3	10 / 5 / 2	250	50	1500	7900	0.08	600	Black
BWCS002317155N6□00	5.6	10 / 5 / 2	250	65	1000	5500	0.08	600	Orange
BWCS002317156N8□00	6.8	10 / 5 / 2	250	50	1000	5500	0.11	600	Brown
BWCS002317157N5□00	7.5	10 / 5 / 2	250	50	1000	4500	0.14	600	Green
BWCS002317158N2□00	8.2	10 / 5 / 2	250	50	1000	4700	0.12	600	Red
BWCS0023171510N□00	10	10 / 5 / 2	250	60	500	4200	0.10	600	Blue
BWCS0023171512N□00	12	10 / 5 / 2	250	50	500	4000	0.15	600	Orange
BWCS0023171515N□00	15	10 / 5 / 2	250	50	500	3400	0.17	600	Yellow
BWCS0023171518N□00	18	10 / 5 / 2	250	50	500	3300	0.20	600	Green
BWCS0023171522N□00	22	10 / 5 / 2	250	55	500	2600	0.22	500	Blue
BWCS0023171524N□00	24	10 / 5 / 2	250	50	500	2000	0.22	500	Gray
BWCS0023171527N□00	27	10 / 5 / 2	250	55	500	2500	0.25	500	Violet
BWCS0023171533N□00	33	10 / 5 / 2	250	60	500	2050	0.27	500	Gray
BWCS0023171536N□00	36	10 / 5 / 2	250	55	500	1700	0.27	500	Orange
BWCS0023171539N□00	39	10 / 5 / 2	250	60	500	2000	0.29	500	White
BWCS0023171543N□00	43	10 / 5 / 2	200	60	500	1650	0.34	500	Yellow
BWCS0023171547N□00	47	10 / 5 / 2	200	60	500	1650	0.31	500	Black
BWCS0023171556N□00	56	10 / 5 / 2	200	60	500	1550	0.34	500	Brown
BWCS0023171568N□00	68	10 / 5 / 2	200	60	500	1450	0.38	500	Red
BWCS0023171582N□00	82	10 / 5 / 2	150	65	500	1300	0.42	400	Orange
BWCS0023171591N□00	91	10 / 5 / 2	150	65	500	1200	0.48	400	Black
BWCS00231715R10□00	100	10 / 5 / 2	150	65	500	1200	0.46	400	Yellow
BWCS00231715R11□00	110	10 / 5 / 2	150	50	250	1000	0.48	400	Brown
BWCS00231715R12□00	120	10 / 5 / 2	150	50	250	1100	0.51	400	Green
BWCS00231715R15□00	150	10 / 5 / 2	100	50	250	920	0.56	400	Blue
BWCS00231715R18□00	180	10 / 5 / 2	100	50	250	870	0.64	400	Violet
BWCS00231715R20□00	200	10 / 5 / 2	100	50	250	860	0.68	400	Red
BWCS00231715R22□00	220	10 / 5 / 2	100	50	250	850	0.70	400	Gray
BWCS00231715R24□00	240	10 / 5 / 2	100	44	250	690	1.00	350	Red

**Note: When ordering, please specify tolerance code. Tolerance : G=±2% , J=±5% , K=±10%**

- Operating temperature range – 40°C ~ 125°C (Including self - temperature rise)
- Irms for a 15°C temperature rise from 25°C ambient with current
- Measure Equipment :  
L & Q : Agilent E4991A+Agilent HP16197A  
SRF : Agilent HP8753D/Agilent E4991A  
RDC : Chroma 16502  
Irms : HP4284A+HP42841A/HP4285A+HP42841A

## SMD Wire Wound Ceramic Chip Inductors – BWCS Series

### Electrical Characteristics

Part Number	Inductance (nH)	Tolerance (±%)	Test Frequency (MHz)	Q Min	Test Frequency (MHz)	SRF (MHz) Min	RDC (Ω) Max	Irms (mA) Max	Color
BWCS00231715R25□00	250	10 / 5 / 2	100	45	250	660	1.20	350	Yellow
BWCS00231715R27□00	270	10 / 5 / 2	100	48	250	650	1.00	350	White
BWCS00231715R30□00	300	10 / 5 / 2	100	25	250	450	1.40	310	Orange
BWCS00231715R33□00	330	10 / 5 / 2	100	48	250	600	1.40	310	Black
BWCS00231715R39□00	390	10 / 5 / 2	100	48	250	560	1.50	290	Brown
BWCS00231715R47□00	470	10 / 5 / 2	50	33	100	450	1.76	250	Violet
BWCS00231715R51□00	510	10 / 5 / 2	25	23	50	340	1.90	230	Gray
BWCS00231715R56□00	560	10 / 5 / 2	25	23	50	340	1.90	230	Orange
BWCS00231715R62□00	620	10 / 5 / 2	25	23	50	220	2.20	210	Yellow
BWCS00231715R68□00	680	10 / 5 / 2	25	23	50	188	2.20	190	Green
BWCS00231715R82□00	820	10 / 5 / 2	25	23	50	215	2.35	180	Blue
BWCS002317151R0□00	1000	10 / 5 / 2	25	20	50	100	2.50	170	Gray
BWCS002317151R2□00	1200	10 / 5	7.9	18	25	100	2.50	170	White
BWCS002317151R8□00	1800	10 / 5 / 2	7.9	16	7.9	80	2.50	170	Orange
BWCS002317152R2□00	2200	10 / 5 / 2	7.9	16	7.9	65	3.90	140	Gray
BWCS002317153R3□00	3300	10 / 5 / 2	7.9	15	7.9	40	4.40	90	Red
BWCS002317154R7□00	4700	10 / 5 / 2	7.9	15	7.9	40	6.40	90	Yellow

**Note:** When ordering, please specify tolerance code. Tolerance : G=±2% , J=±5% , K=±10%

- Operating temperature range – 40°C ~ 125°C (Including self - temperature rise)
- I<sub>rms</sub> for a 15°C temperature rise from 25°C ambient with current
- Measure Equipment :  
 L & Q : Agilent E4991A+Agilent HP16197A  
 SRF : Agilent HP8753D/Agilent E4991A  
 RDC : Chroma 16502  
 I<sub>rms</sub> : HP4284A+HP42841A/HP4285A+HP42841A

Typical L vs. Frequency

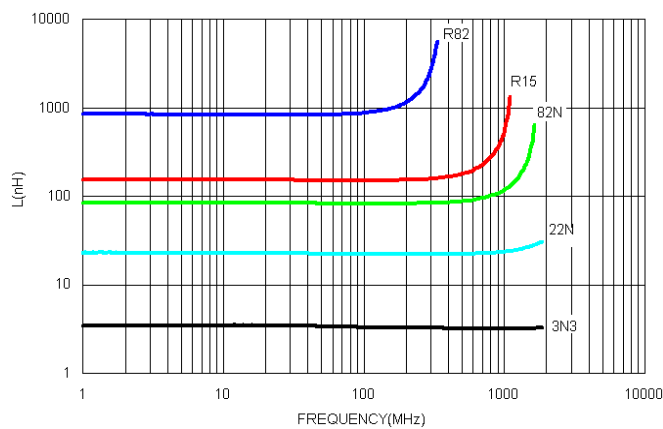

Typical Q vs. Frequency

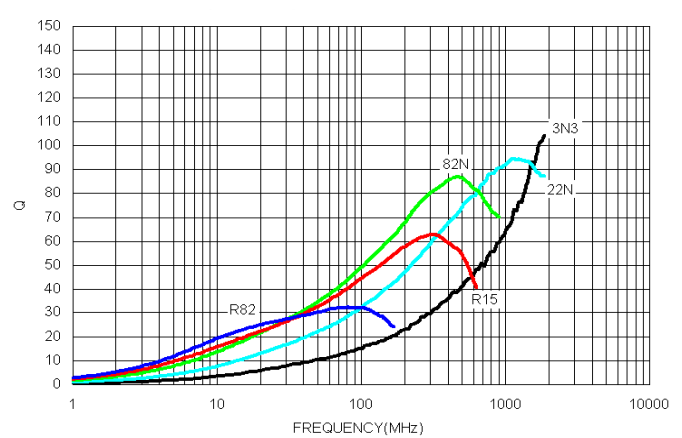

Please be sure to request approval specifications that provide further details of the products. Kindly note that the content of these specifications are subject to change or may be discontinued without prior notice. This product may not be designed/used in medical or high risk applications without Chilisin approval. Please contact our sales department before ordering.



**SMD Wire Wound Ceramic Chip Inductors – BWCS Series****Electrical Characteristics**

Part Number	Inductance (nH)	Tolerance (±%)	Test Frequency (MHz)	Q Min	Test Frequency (MHz)	SRF (MHz)	RDC (Ω)	I <sub>rms</sub> (mA)	Color Coding			offset value (nH)
									1 <sup>ST</sup>	2 <sup>ND</sup>	3 <sup>RD</sup>	
BWCS0029282110N□00	10	10 / 5 / 2	50	50	500	4100	0.08	1000	Brown	Black	Black	-0.4
BWCS0029282112N□00	12	10 / 5 / 2	50	50	500	3300	0.09	1000	Brown	Red	Black	-0.6
BWCS0029282115N□00	15	10 / 5 / 2	50	50	500	2500	0.10	1000	Brown	Green	Black	-0.9
BWCS0029282118N□00	18	10 / 5 / 2	50	50	350	2500	0.11	1000	Brown	Gray	Black	-0.4
BWCS0029282122N□00	22	10 / 5 / 2	50	55	350	2400	0.12	1000	Red	Red	Black	-0.9
BWCS0029282127N□00	27	10 / 5 / 2	50	55	350	1600	0.13	1000	Red	Violet	Black	-1
BWCS0029282133N□00	33	10 / 5 / 2	50	60	350	1600	0.14	1000	Orange	Orange	Black	-1.3
BWCS0029282139N□00	39	10 / 5 / 2	50	60	350	1500	0.15	1000	Orange	White	Black	-1.4
BWCS0029282147N□00	47	10 / 5 / 2	50	65	350	1500	0.16	1000	Yellow	Violet	Black	-1
BWCS0029282156N□00	56	10 / 5 / 2	50	65	350	1300	0.18	1000	Green	Blue	Black	-3.5
BWCS0029282168N□00	68	10 / 5 / 2	50	65	350	1300	0.20	1000	Blue	Gray	Black	-3.5
BWCS0029282182N□00	82	10 / 5 / 2	50	60	350	1000	0.22	1000	Gray	Red	Black	-3.6
BWCS00292821R10□00	100	10 / 5 / 2	25	60	350	1000	0.56	650	Brown	Black	Brown	-6
BWCS00292821R12□00	120	10 / 5 / 2	25	60	350	950	0.63	650	Brown	Red	Brown	-5
BWCS00292821R15□00	150	10 / 5 / 2	25	45	100	850	0.70	580	Brown	Green	Brown	-5
BWCS00292821R18□00	180	10 / 5 / 2	25	45	100	750	0.77	620	Brown	Gray	Brown	-2
BWCS00292821R20□00	200	10 / 5 / 2	25	45	100	700	0.84	500	Red	Black	Brown	0
BWCS00292821R22□00	220	10 / 5 / 2	25	45	100	700	0.84	500	Red	Red	Brown	-15
BWCS00292821R27□00	270	10 / 5 / 2	25	45	100	600	0.91	500	Red	Violet	Brown	-15
BWCS00292821R33□00	330	10 / 5 / 2	25	45	100	570	1.05	450	Orange	Orange	Brown	-20
BWCS00292821R39□00	390	10 / 5 / 2	25	45	100	500	1.12	470	Orange	White	Brown	-25
BWCS00292821R47□00	470	10 / 5 / 2	25	45	100	450	1.19	470	Yellow	Violet	Brown	-35
BWCS00292821R56□00	560	10 / 5 / 2	25	45	100	415	1.33	400	Green	Blue	Brown	-32
BWCS00292821R62□00	620	10 / 5 / 2	25	45	100	375	1.40	300	Blue	Red	Brown	-40
BWCS00292821R68□00	680	10 / 5 / 2	25	45	100	375	1.47	400	Blue	Gray	Brown	-50
BWCS00292821R75□00	750	10 / 5 / 2	25	45	100	360	1.54	360	Violet	Green	Brown	-50
BWCS00292821R82□00	820	10 / 5 / 2	25	45	100	350	1.61	400	Gray	Red	Brown	-55
BWCS00292821R91□00	910	10 / 5 / 2	25	35	50	320	1.68	380	White	Brown	Brown	-80
BWCS002928211R0□00	1000	10 / 5 / 2	25	35	50	290	1.75	370	Brown	Black	Red	-80
BWCS002928211R2□00	1200	10 / 5 / 2	7.9	35	50	250	2.0	310	Brown	Red	Red	-17.8
BWCS002928211R5□00	1500	10 / 5 / 2	7.9	28	50	200	2.3	330	Brown	Green	Red	-29.3
BWCS002928211R8□00	1800	10 / 5 / 2	7.9	28	50	160	2.6	300	Brown	Gray	Red	-42.2

**Note: When ordering, please specify tolerance code. Tolerance : G=±2% , J=±5% , K=±10%**

- Operating temperature range –40°C ~125°C (Including self - temperature rise)
- I<sub>rms</sub> for a 15°C temperature rise from 25°C ambient with current
- Measure Equipment :

L & Q : Agilent E4991A+Agilent HP16197A

SRF : Agilent HP8753D/Agilent E4991A

RDC : Chroma 16502

I<sub>rms</sub> : HP4284A+HP42841A/HP4285A+HP42841A

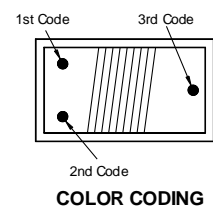

## SMD Wire Wound Ceramic Chip Inductors – BWCS Series

### Electrical Characteristics

Part Number	Inductance (nH)	Tolerance (±%)	Test Frequency (MHz)	Q Min	Test Frequency (MHz)	SRF (MHz)	RDC (Ω)	I <sub>rms</sub> (mA)	Color Coding			offset value (nH)
									1 <sup>ST</sup>	2 <sup>ND</sup>	3 <sup>RD</sup>	
BWCS002928212R2□00	2200	10 / 5 / 2	7.9	28	50	160	2.8	280	Red	Red	Red	-89.6
BWCS002928212R7□00	2700	10 / 5 / 2	7.9	22	25	140	3.2	290	Red	Violet	Red	-75
BWCS002928213R3□00	3300	10 / 5 / 2	7.9	22	25	110	3.4	290	Orange	Orange	Red	-145.6
BWCS002928213R9□00	3900	10 / 5 / 2	7.9	20	25	100	3.6	260	Orange	White	Red	-155.5
BWCS002928214R7□00	4700	10 / 5 / 2	7.9	20	25	90	4.0	260	Yellow	Violet	Red	-227.7
BWCS002928215R6□00	5600	10 / 5 / 2	7.9	18	7.9	45	4.0	240	Green	Blue	Red	0
BWCS002928216R8□00	6800	10 / 5 / 2	7.9	18	7.9	40	4.9	200	Blue	Gray	Red	0
BWCS002928218R2□00	8200	10 / 5 / 2	7.9	18	7.9	25	6.0	170	Gray	Red	Red	0
BWCS00292821100□00	10000	10 / 5 / 2	2.52	18	7.9	25	8.0	150	Brown	Black	Orange	0
BWCS00292821150□00	15000	10 / 5 / 2	2.52	15	7.9	20	11	100	Brown	Green	Orange	0

**Note:** When ordering, please specify tolerance code. Tolerance : G=±2% , J=±5% , K=±10%

- Operating temperature range – 40°C ~ 125°C (Including self - temperature rise)
- I<sub>rms</sub> for a 15°C temperature rise from 25°C ambient with current
- Measure Equipment :  
 L & Q : Agilent E4991A+Agilent HP16197A  
 SRF : Agilent HP8753D/Agilent E4991A  
 RDC : Chroma 16502  
 I<sub>rms</sub> : HP4284A+HP42841A/HP4285A+HP42841A

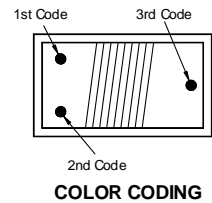

Typical **L** vs. **F** Frequency

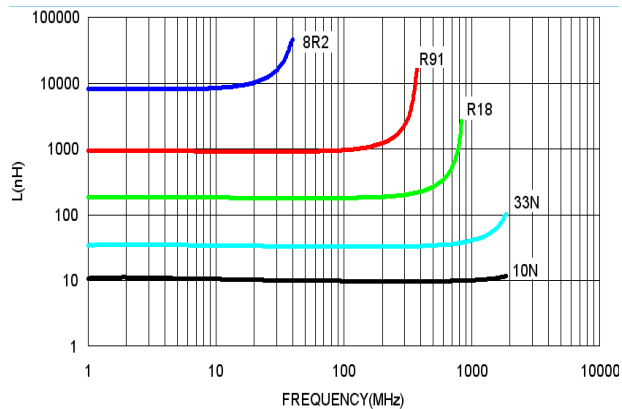

Typical **Q** vs. **F** Frequency

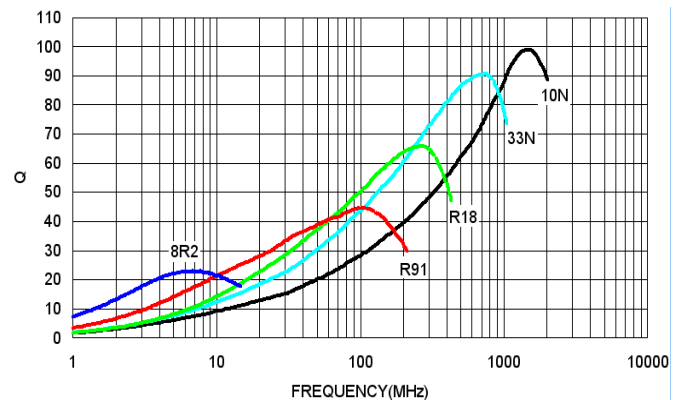

## SMD Wire Wound Ceramic Chip Inductors – BWCS Series

### Electrical Characteristics

Part Number	Inductance (uH)	Tolerance (±%)	Test Frequency (MHz)	Q Min	Test Frequency (MHz)	SRF (MHz) Min	RDC (Ω) Max	Irms (mA) Typ
BWCS004938341R0□00	1.0	5	7.9	60	50	310	1.2	480
BWCS004938341R2□00	1.2	5	7.9	62	50	230	1.2	480
BWCS004938341R5□00	1.5	5 / 2	7.9	65	50	210	1.6	430
BWCS004938341R8□00	1.8	5	7.9	68	50	190	2.0	380
BWCS004938342R2□00	2.2	5 / 2	7.9	63	50	170	2.2	340
BWCS004938342R7□00	2.7	5 / 2	7.9	60	50	160	3.2	300
BWCS004938343R3□00	3.3	5 / 2	7.9	60	50	145	3.8	270
BWCS004938343R9□00	3.9	5 / 2	7.9	61	50	130	5.0	240
BWCS004938344R7□00	4.7	5	7.9	60	50	115	5.4	230
BWCS004938345R6□00	5.6	5	7.9	42	50	100	5.7	220
BWCS004938346R8□00	6.8	5	7.9	32	50	90	6.6	210
BWCS004938348R2□00	8.2	5 / 2	7.9	35	50	80	7.0	200
BWCS00493834100□00	10	5	7.9	27	50	70	7.7	190
BWCS00493834120□00	12	5	2.5	34	10	58	8.7	180
BWCS00493834150□00	15	5 / 2	2.5	32	10	48	9.6	170
BWCS00493834180□00	18	5	2.5	28	10	36	10.5	160
BWCS00493834220□00	22	5 / 2	2.5	28	10	34	11.5	155
BWCS00493834270□00	27	5	2.5	28	10	30	12.5	150
BWCS00493834330□00	33	5 / 2	2.5	20	10	20	13.5	145

**Note:** When ordering, please specify tolerance code. Tolerance : G=±2% , J=±5%

- Operating temperature range—40°C ~ 125°C (Including self - temperature rise)
- Irms for a 15°C temperature rise from 25°C ambient with current
- Measure Equipment :  
 L & Q : HP4286A/HP4287A/AgilentE4991/Keysight E4982A  
 SRF : Agilent HP8753D/Agilent E4991A  
 RDC : Chroma 16502  
 Irms : HP4284A+HP42841A/HP4285A+HP42841A

Typical **L** vs. **F** Frequency

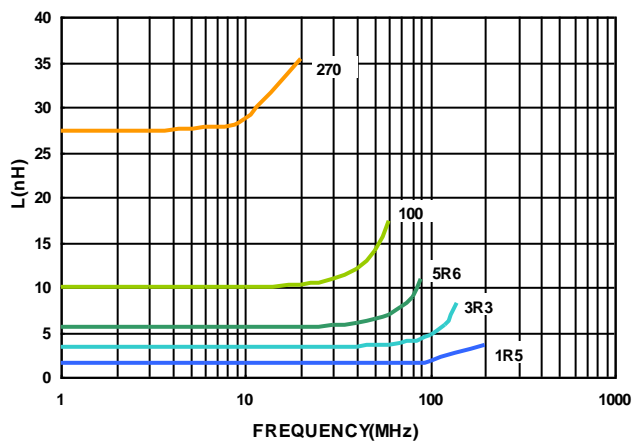

Typical **Q** vs. **F** Frequency

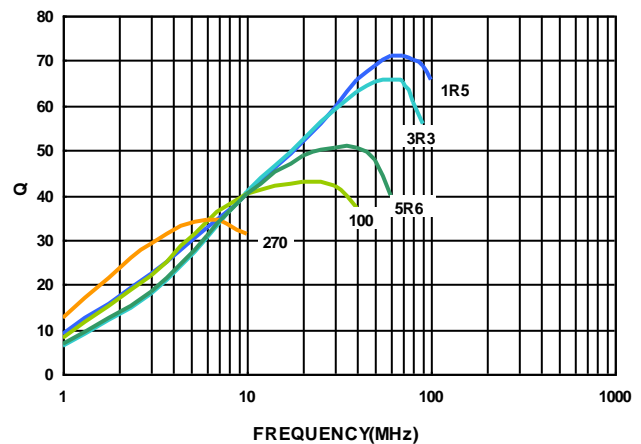

Please be sure to request approval specifications that provide further details of the products. Kindly note that the content of these specifications are subject to change or may be discontinued without prior notice. This product may not be designed/used in medical or high risk applications without Chilisin approval. Please contact our sales department before ordering.

# SMD Wire Wound Ceramic Chip Inductors - BWCS Series

## Packaging Specifications

### Tape Dimensions

Figure 1

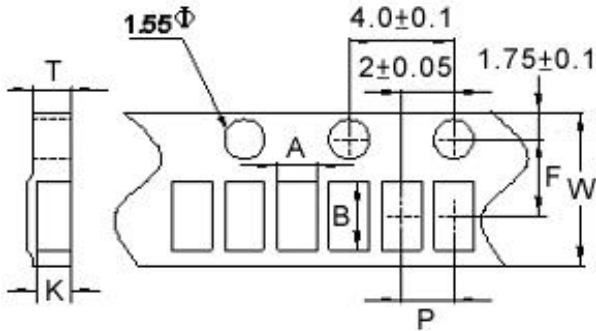

Figure 2

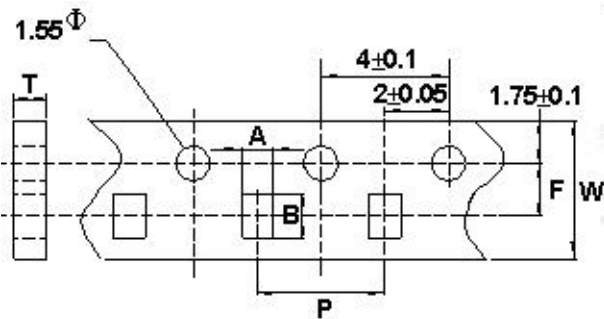
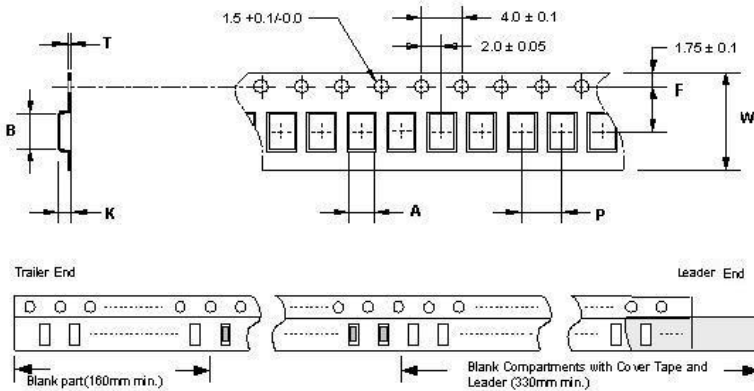
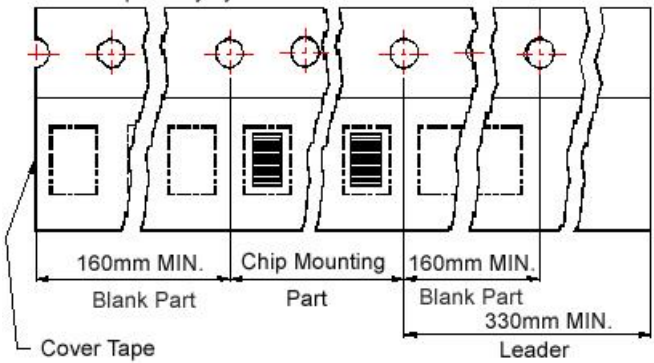

Figure 3



### Tape Material

Carrier Tape: Paper  
Cover Tape: Polystyrene



Carrier Tape: Paper  
Cover Tape: Polystyrene

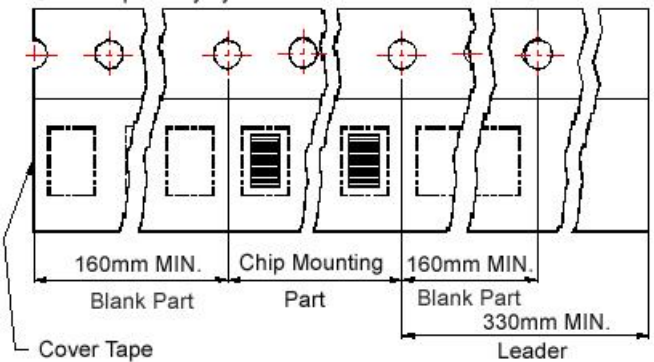

### Reel Dimensions

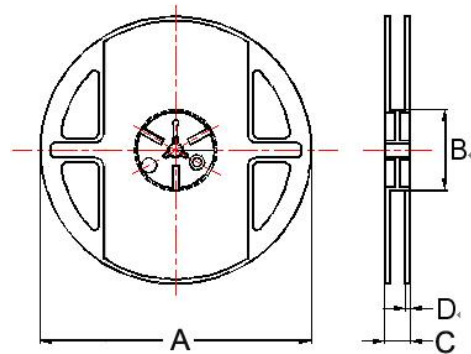

### Dimensions in mm

TYPE	Fig.	Tape Dimensions							Reel Dimensions				Quantity PCS / Reel
		A	B	T	W	P	F	K	A	B	C	D	
BWCS00060404	1	0.47	0.60	0.65	8	2	3.5	0.45	178	60	12	1.5	4000
BWCS00120707	1	0.67	1.20	0.75	8	2	3.5	0.59	178	60	12	1.5	4000
BWCS00161008	2	1.25	1.90	1.05	8	4	3.5	-	178	60	12	1.5	4000
BWCS00231715	3	1.85	2.45	0.23	8	4	3.5	1.70	178	60	12	1.5	2000
BWCS00292821	3	2.80	2.95	0.23	8	4	3.5	2.20	178	60	12	1.5	2000
BWCS00493834	3	3.90	4.90	0.30	12	8	5.5	3.20	178	60	16	1.4	600



## OUR CERTIFICATE

DiGi provide top-quality products and perfect service for customer worldwide through standardization, technological innovation and continuous improvement. DiGi through third-party certification, we stricly control the quality of products and services. Welcome your RFQ to

Email: [Info@DiGi-Electronics.com](mailto:Info@DiGi-Electronics.com)



Tel: +00 852-30501935

RFQ Email: [Info@DiGi-Electronics.com](mailto:Info@DiGi-Electronics.com)

DiGi is a global authorized distributor of electronic components.