

P1167.105NLT Datasheet

www.digi-electronics.com



<https://www.DiGi-Electronics.com>

DiGi Electronics Part Number	P1167.105NLT-DG
Manufacturer	Pulse Electronics
Manufacturer Product Number	P1167.105NLT
Description	FIXED IND 1MH 190MA 4.93 OHM SMD
Detailed Description	1 mH Shielded Wirewound Inductor 190 mA 4.93Ohm Max Nonstandard



Tel: +00 852-30501935

RFQ Email: Info@DiGi-Electronics.com

DiGi is a global authorized distributor of electronic components.

Purchase and inquiry

Manufacturer Product Number:

P1167.105NLT

Series:

P1167NL

Type:

Wirewound

Inductance:

1 mH

Current Rating (Amps):

190 mA

Shielding:

Shielded

Q @ Freq:

-

Ratings:

-

Inductance Frequency - Test:

100 kHz

Mounting Type:

Surface Mount

Supplier Device Package:

-

Height - Seated (Max):

0.177" (4.50mm)

Manufacturer:

Pulse Electronics

Product Status:

Active

Material - Core:

-

Tolerance:

±20%

Current - Saturation (Isat):

190mA

DC Resistance (DCR):

4.93Ohm Max

Frequency - Self Resonant:

1.8MHz

Operating Temperature:

-40°C ~ 130°C

Features:

-

Package / Case:

Nonstandard

Size / Dimension:

0.297" L x 0.297" W (7.54mm x 7.54mm)

Environmental & Export classification

RoHS Status:

ROHS3 Compliant

REACH Status:

REACH Unaffected

HTSUS:

8504.50.4000

Moisture Sensitivity Level (MSL):

1 (Unlimited)





ECCN:

EAR99

SMT Power Inductors

Shielded Drum Core - P1167NL Series



-  **Height:** 4.8mm Max
-  **Footprint:** 7.5mm x 7.5mm Max
-  **Current Rating:** up to 3.5A
-  **Inductance Range:** 1.8 μ H to 750 μ H

Electrical Specifications @ 25°C - Operating Temperature -40°C to +130°C

Part ^{2,3} Number	Inductance @ 0A _{DC} (μ H \pm 20%)	Inductance @ I _{rated} (μ H) MIN	I _{rated} ⁵ (A _{DC})	DCR (m Ω)		Saturation ⁶ Current -25% (A)	Heating ⁷ Current +40°C (A)	Core Loss ⁸ Factor (K2)	SRF (MHz)
				TYP	MAX				
P1167.272NL	2.7*	1.8	3.5	13	16	3.5	3.6	590	>40
P1167.362NL	3.6*	2.3	3.1	15	20	3.1	3.4	690	>40
P1167.452NL	4.5*	2.9	2.6	25	30	2.9	2.6	770	>40
P1167.542NL	5.4*	3.5	2.5	27	33	2.7	2.5	840	>40
P1167.632NL	6.3*	4.1	2.4	30	35	2.5	2.4	900	36
P1167.103NL	10	7.5	2.0	42	50	2.1	2.0	1100	26
P1167.123NL	12	9.0	1.9	46	57	1.9	1.9	1200	24
P1167.153NL	15	11.3	1.7	53	66	1.7	1.8	1300	20
P1167.183NL **	18	13.5	1.5	59	73	1.5	1.7	1400	18
P1167.223NL	22	16.5	1.4	87	105	1.4	1.4	1700	17
P1167.273NL	27	20.3	1.2	100	130	1.2	1.3	1800	15
P1167.333NL	33	24.8	1.1	139	170	1.1	1.1	2000	13
P1167.393NL **	39	29.3	1.0	156	200	1.0	1.0	2200	12
P1167.473NL	47	35.3	0.94	173	220	0.94	1.0	2400	10
P1167.563NL	56	42	0.86	225	270	0.86	0.86	2600	9.2
P1167.683NL	68	51	0.78	251	310	0.78	0.81	2900	8.8
P1167.823NL	82	61.5	0.7	282	350	0.7	0.77	3200	8.0
P1167.104NL	100	75	0.63	317	390	0.63	0.72	3500	6.2
P1167.124NL **	120	90	0.57	418	530	0.57	0.63	3900	6.1
P1167.154NL	150	113	0.52	497	610	0.52	0.58	4300	5.6
P1167.184NL	180	135	0.47	635	820	0.47	0.51	4800	4.5
P1167.224NL	220	165	0.43	745	930	0.43	0.47	5200	4.3
P1167.274NL	270	203	0.39	840	1040	0.39	0.44	5700	3.8
P1167.334NL	330	248	0.35	1162	1470	0.35	0.38	6400	3.0
P1167.394NL **	390	293	0.32	1237	1570	0.32	0.37	6900	2.8
P1167.474NL	470	353	0.29	1688	2180	0.29	0.31	7600	2.6
P1167.564NL **	560	420	0.26	2240	2960	0.26	0.27	8300	2.4
P1167.684NL	680	510	0.23	2402	3180	0.23	0.26	9300	2.1
P1167.824NL	820	615	0.21	2702	3500	0.21	0.25	10000	2.0
P1167.105NL	1000	750	0.19	3703	4930	0.19	0.21	11000	1.8

* Inductance is at 0A_{DC} tolerance on indicated part numbers is \pm 30%; tolerance is \pm 20% on all other parts.

** Contact Pulse for availability

SMT Power Inductors

Shielded Drum Core - P1167NL Series



Mechanical

Schematic

P1167.XXXNL

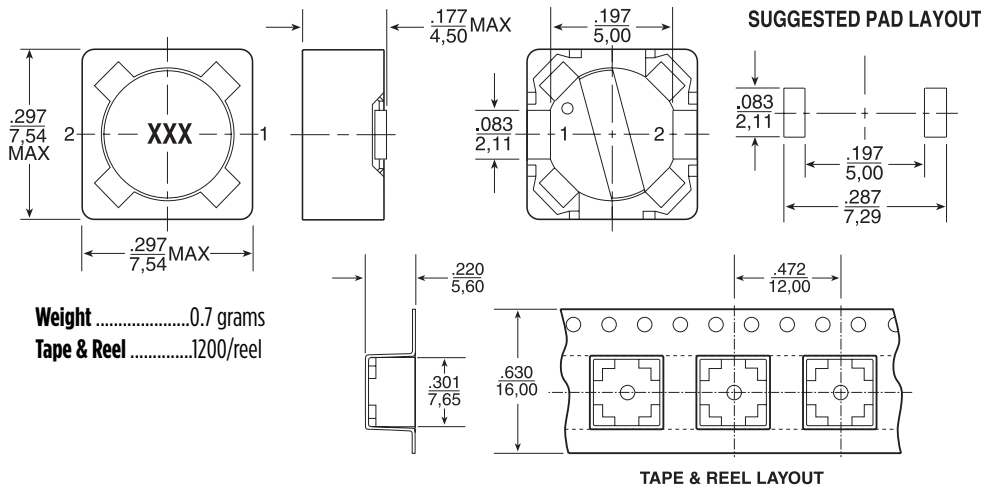

Weight0.7 grams
Tape & Reel1200/reel

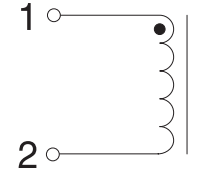

Dimensions: $\frac{\text{Inches}}{\text{mm}}$
Unless otherwise specified,
all tolerances are: $\pm \frac{.010}{0,25}$

Notes:

1. Unless otherwise specified, all testing is made at 100kHz, 0.1VAC.
2. Optional Tape & Reel packaging can be ordered by adding a "T" suffix to the part number (i.e P1166.102NL becomes P1166.102NLT). Pulse complies with industry standard Tape and Tape & Reel specification EIA481.
3. The "NL" suffix indicates an RoHS-compliant part number. Non-NL suffixed parts are not necessarily RoHS compliant, but are electrically and mechanically equivalent to NL versions. If a part number does not have the "NL" version, but an RoHS compliant version is required, please contact Pulse for availability.
4. Temperature of the component (ambient plus temperature rise) must be within specified operating temperature range.
5. The rated current (I_{rated}) as listed is either the saturation current or the heating current depending on which value is lower.
6. The saturation current, I_{sat}, is the current at which the component inductance drops by the indicated percentage (typical) at an ambient temperature of 25C. This current is determined by placing the component in the specified ambient environment and applying a short duration pulse current (to eliminate self-heating effects) to the component.
7. The heating current, I_{dc}, is the DC current required to raise the component temperature by the indicated delta (approximately). The heating current is determined by mounting the component on a typical PCB and applying current for 30 minutes. The temperature is measured by placing the thermocouple on top of the unit under test.

8. In high volt*time (Et) or ripple current applications, additional heating in the component can occur due to core losses in the inductor which may necessitate derating the current in order to limit the temperature rise of the component. In order to determine the approximate total loss (or temperature rise) for a given application, both copper losses and core losses should be taken into account.

Estimated Temperature Rise:

$$\text{Trise} = [\text{Total loss (mW)} / K0]^{.833} (^\circ\text{C})$$

$$\text{Total Loss} = \text{Copper loss} + \text{Core loss (mW)}$$

$$\text{Copper loss} = I_{\text{RMS}}^2 \times \text{DCR (Typical)} \text{ (mW)}$$

$$I_{\text{RMS}} = [I_{\text{DC}}^2 + \Delta I^2 / 12]^{1/2} \text{ (A)}$$

$$\text{Core loss} = K1 \times f \text{ (kHz)}^{1.25} \times B_{\text{ac}} \text{ (Ga)}^{2.38} \text{ (mW)}$$

$$B_{\text{ac}} \text{ (peak to peak flux density)} = K2 \times \Delta I \text{ (Ga)}$$

$$[= K2/L \text{ (\mu H)} \times Et \text{ (V-\mu Sec)} \text{ (Ga)}]$$

where f varies between 25kHz and 1MHz, and B_{ac} is less than 2500 Gauss.

K2 is a core size and winding dependent value and is given for each p/n in the preceding datasheets. K0 & K1 are platform and material dependant constants and are given in the table below for each platform.

SMT Power Inductors

Shielded Drum Core - P1167NL Series



Part No.	Trise Factor (K0)	Core Loss Factor (K1)
PG0085/86	2.3	5.29E-10
PG0087	5.8	15.2E-10
PG0040/41	0.8	2.80E-10
P1174	0.8	6.47E-10
PF0601	4.6	14.0E-10
PF0464	3.6	24.7E-10
PF0465	3.6	33.4E-10
P1166	1.9	29.6E-10
P1167	2.1	42.2E-10
PF0560NL	5.5	136E-10
P1168/69	4.8	184E-10
P1170/71	4.3	201E-10
P1172/73	5.6	411E-10
PF0552NL	8.3	201E-10
PF0553NL	7.1	411E-10

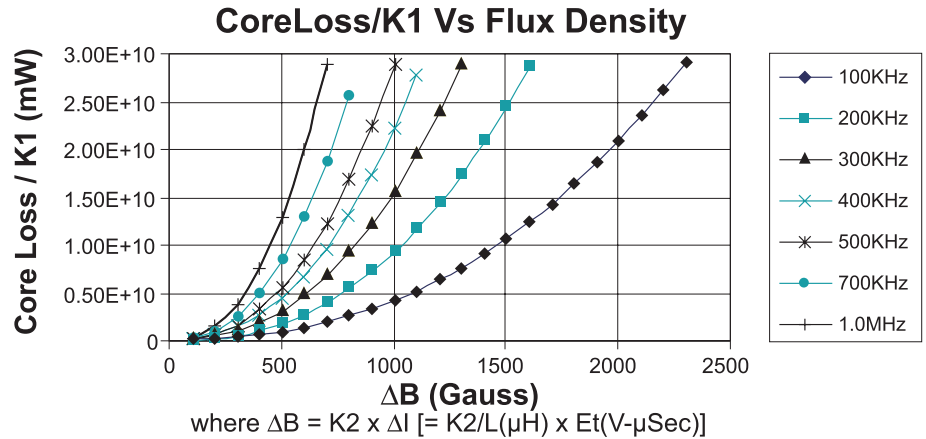

Take note that the component's temperature rise varies depending on the system condition. It is suggested that the component be tested at the system level, to verify the temperature rise of the component during system operation.

For More Information

Pulse Worldwide Headquarters

15255 Innovation Drive Ste 100
San Diego, CA 92128
U.S.A.

Pulse Europe

Pulse Electronics GmbH
Am Rottland 12
58540 Meinerzhagen
Germany

Pulse China Headquarters

Pulse Electronics (ShenZhen) CO., LTD
D708, Shenzhen Academy of
Aerospace Technology,
The 10th Keji South Road,
Nanshan District, Shenzhen,
P.R. China 518057

Pulse North China

Room 2704/2705
Super Ocean Finance Ctr.
2067 Yan An Road West
Shanghai 200336
China

Pulse South Asia

3 Fraser Street 0428
DUO Tower
Singapore 189352

Pulse North Asia

1F., No.111 Xiyuan Road
Zhongli District
Taoyuan City 32057
Taiwan (R.O.C)

Tel: 858 674 8100
Fax: 858 674 8262

Tel: 49 2354 777 100
Fax: 49 2354 777 168

Tel: 86 755 33966678
Fax: 86 755 33966700

Tel: 86 21 62787060
Fax: 86 2162786973

Tel: 65 6287 8998
Fax: 65 6280 0080

Tel: 886 3 4356768
Fax: 886 3 4356820

Performance warranty of products offered on this data sheet is limited to the parameters specified. Data is subject to change without notice. Other brand and product names mentioned herein may be trademarks or registered trademarks of their respective owners. © Copyright, 2019. Pulse Electronics, Inc. All rights reserved.

OUR CERTIFICATE

DiGi provide top-quality products and perfect service for customer worldwide through standardization, technological innovation and continuous improvement. DiGi through third-party certification, we strictly control the quality of products and services. Welcome your RFQ to

Email: Info@DiGi-Electronics.com



Tel: +00 852-30501935

RFQ Email: Info@DiGi-Electronics.com

DiGi is a global authorized distributor of electronic components.