

# PG0016.152NL Datasheet



DiGi Electronics Part Number	PG0016.152NL-DG
Manufacturer	<a href="#">Pulse Electronics</a>
Manufacturer Product Number	PG0016.152NL
Description	FIXED IND 1.5UH 4A 16 MOHM SMD
Detailed Description	1.5 $\mu$ H Unshielded Wirewound Inductor 4 A 16mOhm 2420 (6050 Metric)

<https://www.DiGi-Electronics.com>



Tel: +00 852-30501935

RFQ Email: [Info@DiGi-Electronics.com](mailto:Info@DiGi-Electronics.com)

DiGi is a global authorized distributor of electronic components.

## Purchase and inquiry

Manufacturer Product Number:

PG0016.152NL

Series:

PG0016NL

Type:

Wirewound

Inductance:

1.5  $\mu$ H

Current Rating (Amps):

4 A

Shielding:

Unshielded

Q @ Freq:

-

Ratings:

-

Features:

-

Package / Case:

2420 (6050 Metric)

Size / Dimension:

0.236" L x 0.213" W (6.00mm x 5.40mm)

Manufacturer:

Pulse Electronics

Product Status:

Active

Material - Core:

-

Tolerance:

$\pm$ 15%

Current - Saturation (Isat):

6.1A

DC Resistance (DCR):

16mOhm

Frequency - Self Resonant:

-

Operating Temperature:

-40°C ~ 130°C

Mounting Type:

Surface Mount

Supplier Device Package:

-

Height - Seated (Max):

0.191" (4.85mm)

## Environmental & Export classification

RoHS Status:

ROHS3 Compliant

REACH Status:

REACH Unaffected

HTSUS:

8504.50.8000

Moisture Sensitivity Level (MSL):

1 (Unlimited)

ECCN:





EAR99



# SMT POWER INDUCTORS

## Unshielded Drum Core – PG0016NL Series



-  **Current Rating:** up to 8.5A
-  **Inductance Range:** 0.33μH to 220μH
-  **Height:** 4.85 mm Max
-  **Footprint:** 6.0mm x 5.4mm MAX

### Electrical Specifications @ 25°C — Operating Temperature -40°C to +130°C<sup>6</sup>

Part <sup>5</sup> Number	Inductance @I <sub>rated</sub> <sup>1</sup> (μH TYP)	I <sub>rated</sub> <sup>2</sup> (A)	DCR (mΩ)	Inductance @ 0A <sub>dc</sub> (μH ± 15%)	Saturation Current <sup>3</sup> I <sub>sat</sub> (A TYP)	Heating Current <sup>4</sup> I <sub>dc</sub> (A TYP)
PG0016.331NL	0.29	8.5	4.3	0.33	13	8.5
PG0016.561NL	0.48	6.6	6.5	0.56	10	6.6
PG0016.681NL	0.68	6.0	7.0	0.68	8.0	6.0
PG0016.821NL	0.71	6.0	11	0.82	7.8	6.0
PG0016.102NL	1.0	4.5	13	1.0	6.8	4.5
PG0016.152NL	1.3	4.0	16	1.5	6.1	4.0
PG0016.222NL	2.1	3.2	23	2.2	5.0	3.2
PG0016.272NL	2.7	2.9	25	2.7	4.2	2.9
PG0016.332NL	3.1	2.6	30	3.3	4.0	2.6
PG0016.472NL	4.2	2.3	34	4.7	3.3	2.3
PG0016.682NL	6.1	1.8	55	6.8	2.9	1.8
PG0016.822NL	7.4	1.7	60	8.2	2.6	1.7
PG0016.103NL	10	1.5	80	10	2.3	1.5
PG0016.123NL	12	1.4	120	12	2.1	1.4
PG0016.153NL	14	1.3	140	15	1.8	1.3
PG0016.183NL	18	1.2	150	18	1.6	1.2
PG0016.223NL	21	1.1	180	22	1.6	1.1
PG0016.273NL	27	0.97	200	27	1.4	0.97
PG0016.333NL	33	0.88	230	33	1.3	0.88
PG0016.393NL	39	0.80	320	39	1.1	0.80
PG0016.473NL	46	0.72	370	47	1.0	0.72
PG0016.563NL	56	0.68	420	56	0.95	0.68
PG0016.683NL	68	0.61	530	68	0.80	0.61
PG0016.823NL	82	0.58	600	82	0.70	0.58
PG0016.104NL	100	0.52	840	100	0.70	0.52
PG0016.124NL	120	0.48	930	120	0.60	0.48
PG0016.154NL	150	0.40	1250	150	0.55	0.40
PG0016.184NL	180	0.38	1400	180	0.50	0.38
PG0016.224NL	217	0.35	1600	220	0.50	0.35

### Mechanical

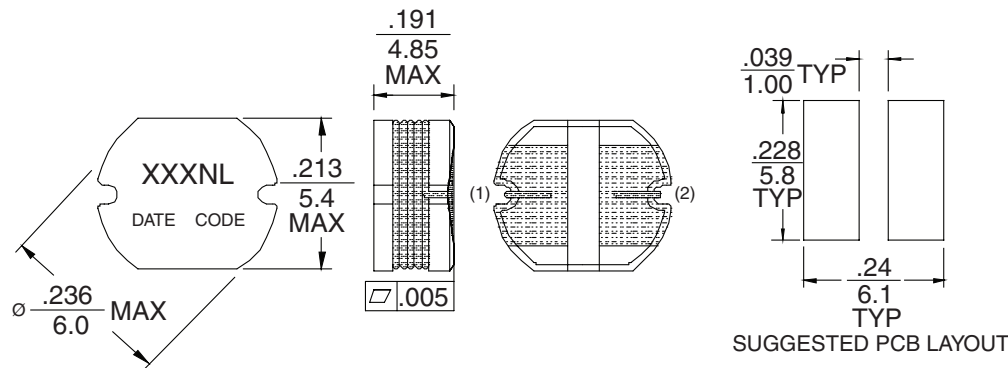

### Schematic

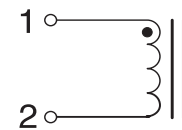

Weight . . . . . 0.46 grams  
Tape & Reel . . . . 1400pcs/reel

Dimensions:  $\frac{\text{Inches}}{\text{mm}}$   
Unless otherwise specified,  
all tolerances are  $\pm \frac{.004}{0,10}$

# SMT POWER INDUCTORS

## Unshielded Drum Core – PG0016NL Series



### NOTES:

1. Inductance at Irated is a typical inductance value for the component taken at rated current.
2. The rated current listed is the lower of the saturation current @ 25°C or the heating current.
3. The saturation current, Isat, is the current at which the component inductance drops by 10% (typ.) at an ambient temperature of 25°C. This current is determined by placing the component in the specified ambient environment and applying a short duration pulse current (to eliminate self-heating effects) to the component.
4. The heating current, IDC, is the DC current required to raise the component temperature by approximately 40°C. The heating current is determined by mounting the component on a typical PCB and applying current for 30 minutes.
5. Optional Tape & Reel packaging can be ordered by adding a "T" suffix to the part number (i.e. PG0016.331NL becomes PG0016.331NLT). Pulse complies to industry standard tape and reel specification EIA481.
6. The temperature of the component (ambient plus temperature rise) must be within the stated operating temperature range.

### Typical Inductance vs. Current Characteristics

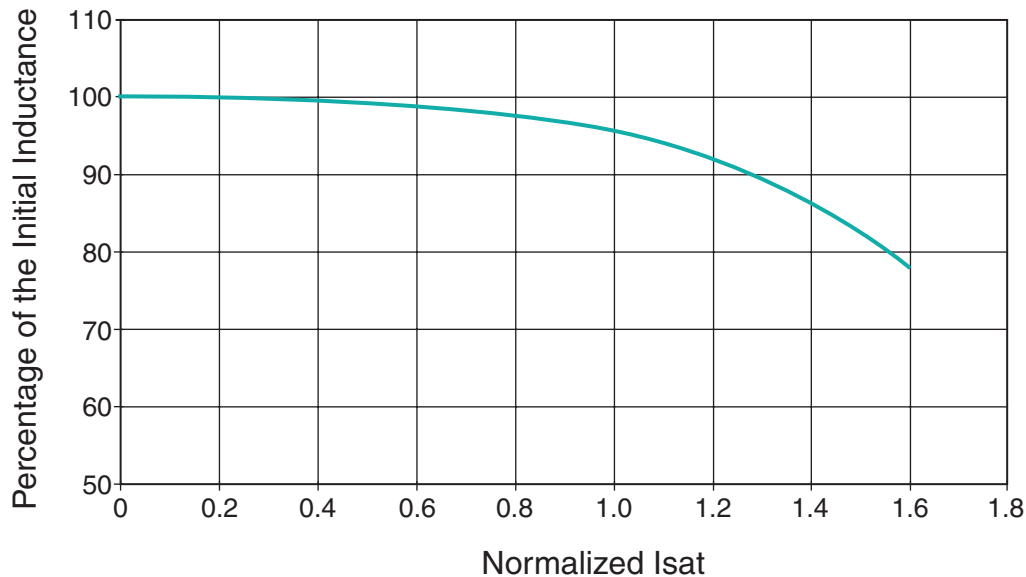

### For More Information:

#### Pulse Worldwide Headquarters

12220 World Trade Dr.  
San Diego, CA 92128  
U.S.A.

[www.pulseeng.com](http://www.pulseeng.com)

Tel: 858 674 8100  
Fax: 858 674 8262

#### Pulse Europe

Einsteinstrasse 1  
D-71083 Herrenberg  
Germany

Tel: 49 7032 7806 0

Fax: 49 7032 7806 135

#### Pulse China Headquarters

B402, Shenzhen Academy of  
Aerospace Technology Bldg.  
10th Kejinan Rd.  
High-Tech Zone  
Nanshan District  
Shenzen, PR China 518057

TEL: 86 755 33966678

FAX: 86 755 33966700

#### Pulse North China

Room 1503  
XinYin Building  
No. 888 YiShan Rd.  
Shanghai 200233  
China

Tel: 86 21 54643211/2

Fax: 86 21 54643210

#### Pulse South Asia

135 Joo Seng Rd.  
#03-02  
PM Industrial Bldg.  
Singapore 368363

TEL: 65 6287 8998

FAX: 65 6280 0080

#### Pulse North Asia

No. 26, Kao Ching Rd.  
Yang Mei Chen  
Taoyuan Hsien  
Taiwan  
R. O. C.

Tel: 886 3 4643715

Fax: 886 3 4641911

Performance warranty of products offered on this data sheet is limited to the parameters specified. Data is subject to change without notice. Other brand and product names mentioned herein may be trademarks or registered trademarks of their respective owners.

© Copyright, 2009. Pulse Engineering, Inc. All rights reserved.

[www.pulseeng.com](http://www.pulseeng.com)

P683.A (5/09)



## OUR CERTIFICATE

DiGi provide top-quality products and perfect service for customer worldwide through standardization, technological innovation and continuous improvement. DiGi through third-party certification, we stricly control the quality of products and services. Welcome your RFQ to

Email: [Info@DiGi-Electronics.com](mailto:Info@DiGi-Electronics.com)



Tel: +00 852-30501935

RFQ Email: [Info@DiGi-Electronics.com](mailto:Info@DiGi-Electronics.com)

DiGi is a global authorized distributor of electronic components.