

R591702610 Datasheet

www.digi-electronics.com



<https://www.DiGi-Electronics.com>

DiGi Electronics Part Number	R591702610-DG
Manufacturer	Radiall USA, Inc.
Manufacturer Product Number	R591702610
Description	IC RF SWITCH SP6T 26.5GHZ MODULE
Detailed Description	RF Switch IC General Purpose SP6T 50Ohm Module

This model R591702610 is available at DiGi Electronics.

DiGi Electronics offers a global database of semiconductor and electronic component datasheets.

We welcome your inquiries regarding pricing, lead time, or other product-related questions.

 [Request a Quote](#)

 [Datasheet Search](#)



Tel: +00 852-30501935

RFQ Email: Info@DiGi-Electronics.com

DiGi is a global authorized distributor of electronic components.

Purchase and inquiry

Manufacturer Product Number:

R591702610

Series:

-

RF Type:

General Purpose

Circuit:

SP6T

Isolation:

55dB (min)

Test Frequency:

26.5GHz

IIP3:

-

Impedance:

50Ohm

Operating Temperature:

-40°C ~ 85°C

Supplier Device Package:

Module

Manufacturer:

Radiall USA, Inc.

Product Status:

Active

Topology:

-

Frequency Range:

0Hz ~ 26.5GHz

Insertion Loss:

0.6dB (Max)

P1dB:

-

Features:

-

Voltage - Supply:

10.2V ~ 13V

Package / Case:

Module, SMA Connectors

Environmental & Export classification

RoHS Status:

ROHS3 Compliant

Moisture Sensitivity Level (MSL):

Not Applicable

PAGE 1/8

ISSUE 09-02-18

SERIES SPnT

PART NUMBER R591 XXX XXX

SPnT Coaxial Subminiature Switches DC to 6 GHz, DC to 26.5 GHz, DC to 40 GHz

R591 RADIALL coaxial subminiature switches have a typical operating life exceeding 25 million cycles. Excellent RF & repeatability characteristics along with a guaranteed life of 10 million cycles make these switches ideal for Automated Test Equipment (ATE) and other measurement applications. These miniature switches are also an excellent choice for Mil/Aero applications due to their small size, light weight, as well as outstanding shock and vibration handling capabilities.

PART NUMBER SELECTION

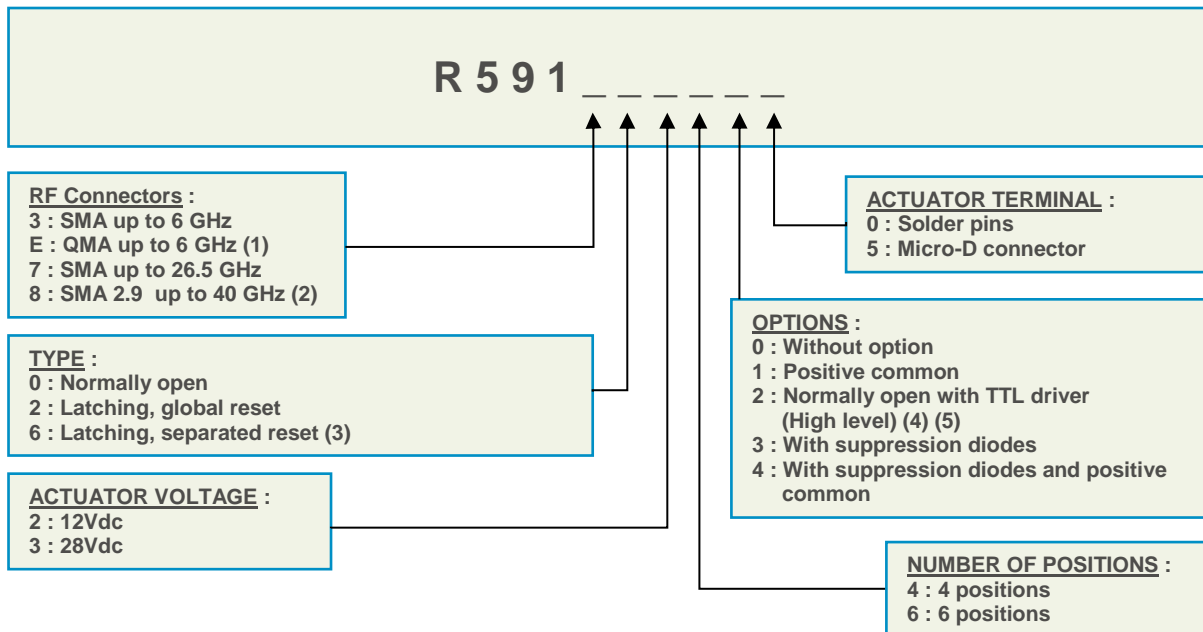

- (1) The "QLF" trademark (quick lock formula®) standard applies to QMA and QN series and guarantees the full interchangeability between suppliers using this trademark. Using QLF certified connectors also guarantees the specified level of RF performances.
- (2) Connector SMA2.9 is equivalent to "K Connector®", registered trademark of Anritsu
- (3) Available with "solder pins" models only
- (4) Polarity is not relevant to application for switches with TTL driver
- (5) Suppression diodes are already included with TTL option



PICTURE





PAGE 2/8

ISSUE 09-02-18

SERIES SPnT

PART NUMBER R591 XXX XXX

GENERAL SPECIFICATIONS

Operating mode		Normally open		Latching	
Nominal operating voltage (Vdc) (across operating temperature range)		12 (10.2 / 13)	28 (21 / 30)	12 (10.2 / 13)	28 (21 / 30)
Coil resistance (+/-10%) (Ohms)		48	250	60	285
Nominal operating current at 23°C (mA)		250	110	200	98
Average power		See Power Rating Chart on final page			
TTL input	High Level	2.2 to 5.5 Volts			
	Low Level	0 to 0.8 V			
Switching time max (ms)		10			
Life min for	SMA / QMA	10 million cycles			
	SMA 2.9	2 million cycles			
Connectors		SMA – QMA – SMA 2.9			
Actuator terminals	Solder Pins	Solder pins double row connector for wrapping, soldering (250°C max / 30 sec), or connecting to 2.54 mm pitch female connector.			
	9 pin micro-D	9 pin micro-D receptacle M83513/07-A according to MIL-C-85513.			
Operating temperature range (°C)		-40 to +85			
Storage temperature range (°C)		-55 to +85			
Sine vibration (According to MIL STD 202, Method 204D, Cond. D)		10-2000 Hz, 20g	operating		
Random vibration (According to MIL STD 202, Method 214A, Profile I, Cond. F)		50-2000 Hz, 20.71grms	operating		
Shock (According to MIL STD 202, Method 213B, Cond. C)		100g / 6 ms, ½ sine	operating		

RF PERFORMANCES

Connectors	Frequency Range GHz	V.S.W.R. (max)	Insertion Loss (max) dB	Isolation (min) dB	Max. average power (W) (1)	Impedance Ohms	
SMA / QMA	DC – 6	DC – 3	1.20	0.20	80	250	50
		3 – 6	1.30	0.30	70	170	
SMA	DC – 26.5	DC – 3	1.20	0.20	80	250	50
		3 – 8	1.30	0.30	70	150	
		8 – 12.4	1.40	0.40	60	120	
		12.4 – 18	1.50	0.50	60	100	
		18 – 26.5	1.60	0.60	55	40	
SMA2.9	DC – 40	DC – 3	1.20	0.20	80	60	50
		3 – 8	1.30	0.30	70	35	
		8 – 12.4	1.40	0.40	60	30	
		12.4 – 18	1.50	0.50	60	25	
		18 – 26.5	1.70	0.70	55	15	
		26.5 – 40	2.20	1.10	45	5	

TYPICAL RF PERFORMANCES
Insertion Loss and Isolation :

- 26.5GHz model with SMA connector
— 40GHz model with SMA2.9 connector

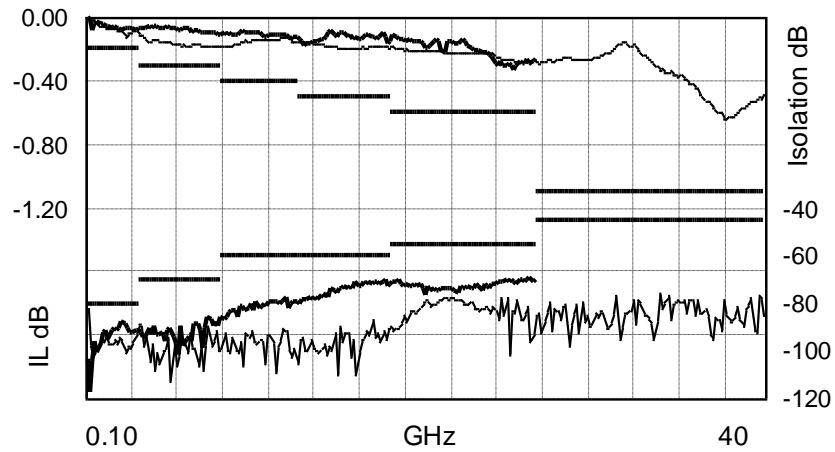

V.S.W.R :

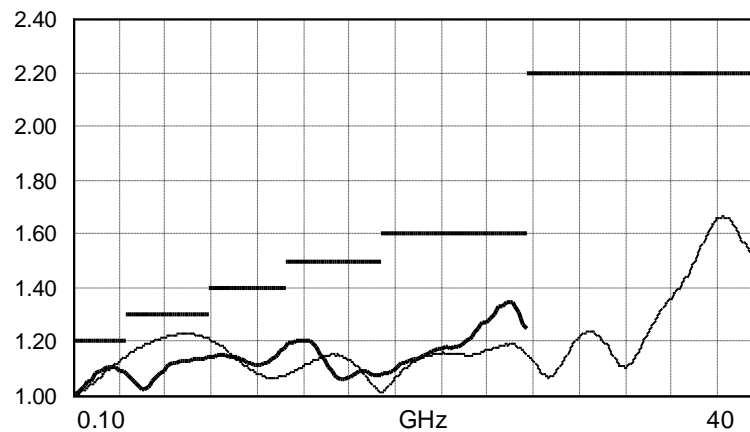
- 26.5GHz model with SMA connector
— 40GHz model with SMA2.9 connector

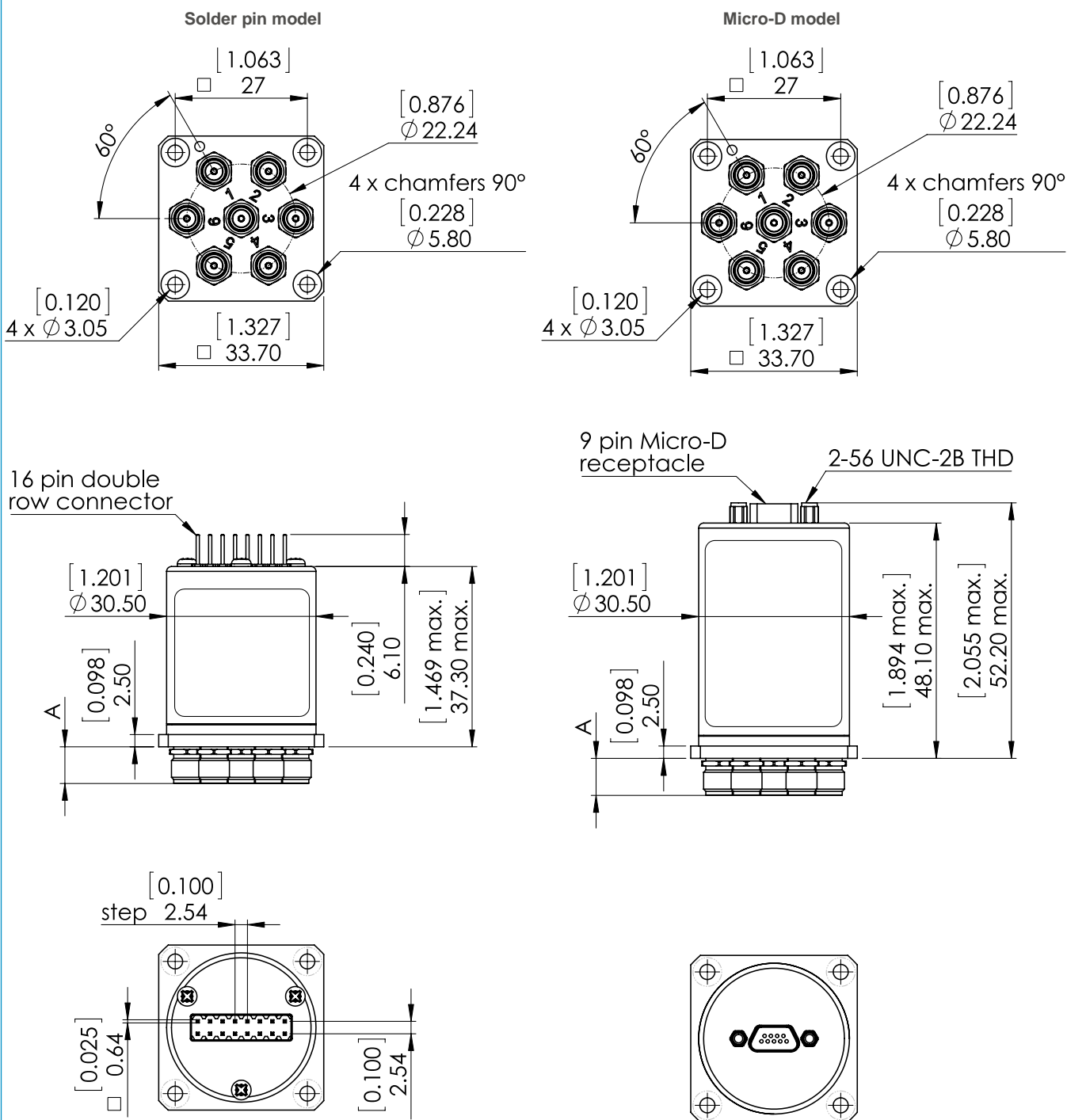

PAGE 4/8	ISSUE 09-02-18	SERIES SPnT	PART NUMBER R591 XXX XXX
----------	----------------	-------------	--------------------------

TYPICAL OUTLINE DRAWING



All dimensions are in millimetres.[inches]
General tolerances: ±0.5 mm [0.02 in]

Connectors	SMA	SMA2.9	QMA
A max (mm / inches)	7.7 / 0.303	6.7 / 0.264	10.8 / 0.425

Ways 3 and 6 are not connected for SP4T

R591 SERIES ELECTRICAL SCHEMATICS

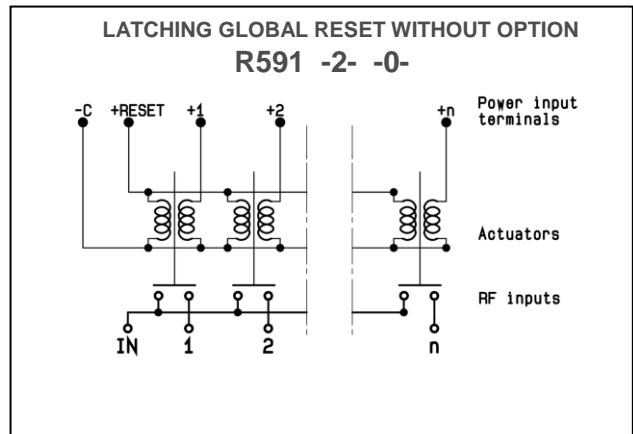
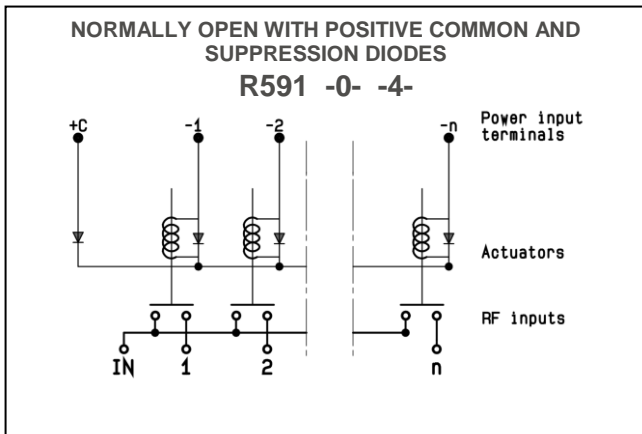
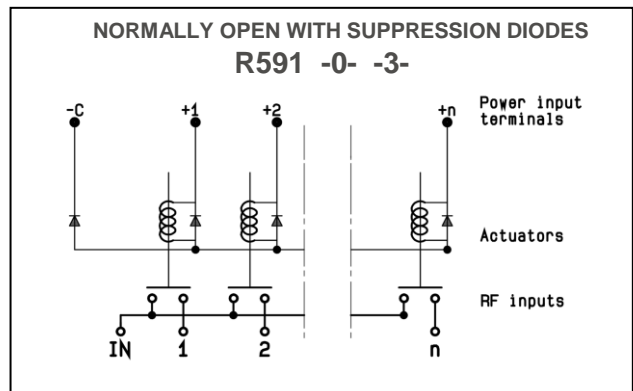
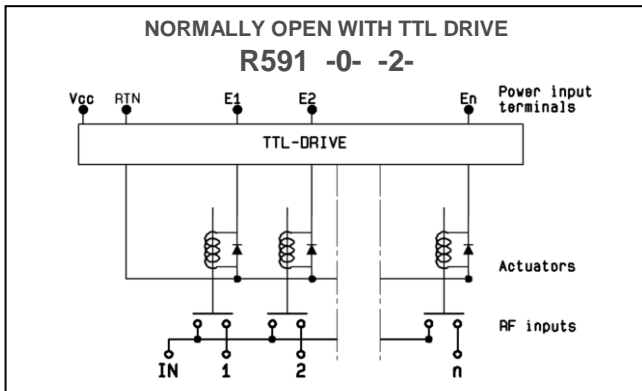
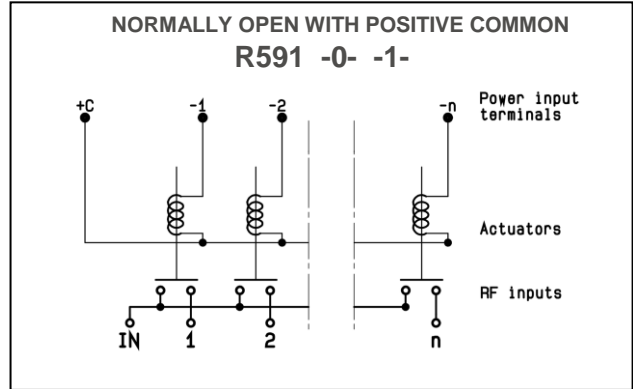
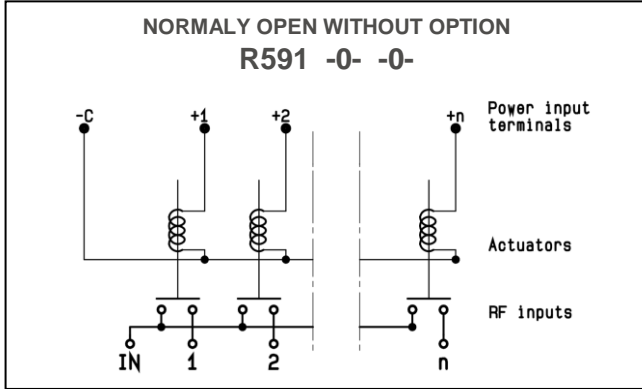

LATCHING GLOBAL RESET WITH POSITIVE COMMON
R591 -2- -1-

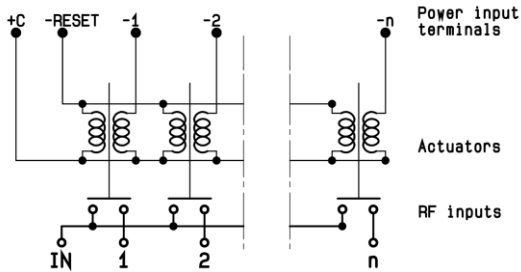

LATCHING GLOBAL RESET WITH SUPPRESSION DIODES
R591 -2- -3-

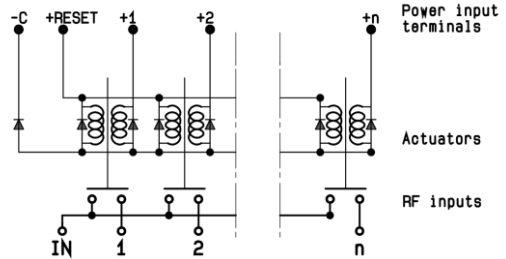

LATCHING GLOBAL RESET WITH POSITIVE COMMON AND SUPPRESSION DIODES
R591 -2- -4-

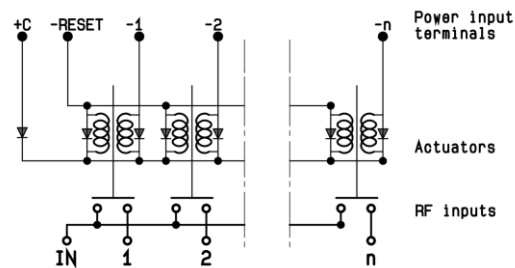

LATCHING SEPARATED RESET WITHOUT OPTION
R591 -6- -0-

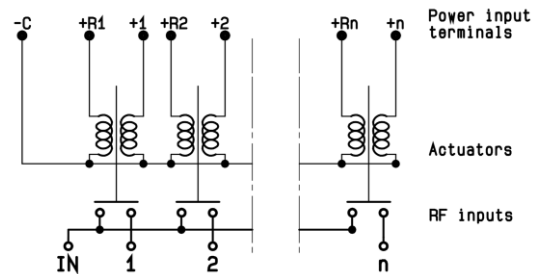

LATCHING SEPARATED RESET WITH POSITIVE COMMON
R591 -6- -1-

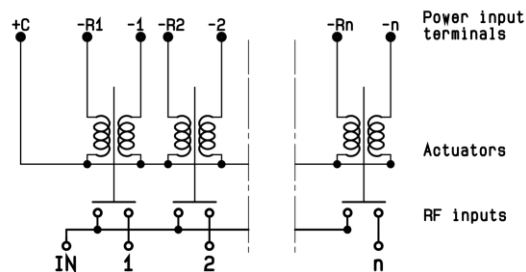

LATCHING SEPARATED RESET WITH SUPPRESSION DIODES
R591 -6- -3-

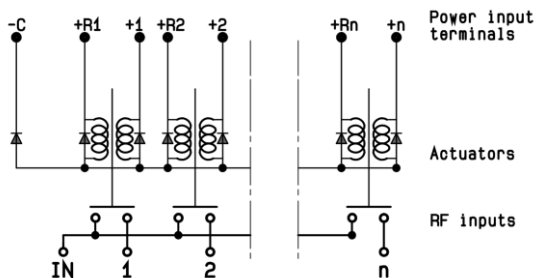

LATCHING SEPARATED RESET WITH POSITIVE COMMON AND SUPPRESSION DIODES
R591 -6- -4-

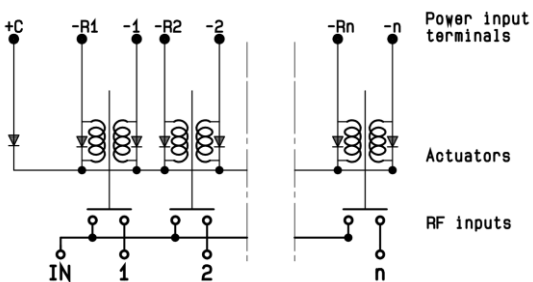

PAGE 7/8	ISSUE 09-02-18	SERIES SPnT	PART NUMBER R591 XXX XXX
----------	----------------	-------------	--------------------------

Pin identification

Solder pins (Top view) *

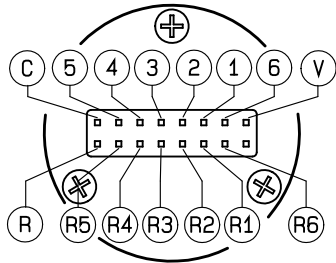

9 pin Micro-D (Top view)

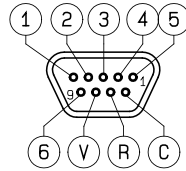

* : Compatible with 2.54 pitch double row 16 contacts female connector

Type		PIN														
		C	V	1	2	3	4	5	6	R	R1	R2	R3	R4	R5	R6
Normally open	Negative common	-C	NC	+1	+2	+3	+4	+5	+6	NC	NC	NC	NC	NC	NC	NC
	Positive common	+C	NC	-1	-2	-3	-4	-5	-6	NC	NC	NC	NC	NC	NC	NC
Latching	Negative common	-C	NC	+1	+2	+3	+4	+5	+6	+reset	NC	NC	NC	NC	NC	NC
global reset	Positive common	+C	NC	-1	-2	-3	-4	-5	-6	-reset	NC	NC	NC	NC	NC	NC
Latching	Negative common	-C	NC	+1	+2	+3	+4	+5	+6	NC	+res.1	+res.2	+res.3	+res.4	+res.5	+res.6
individual reset	Positive common	+C	NC	-1	-2	-3	-4	-5	-6	NC	-res.1	-res.2	-res.3	-res.4	-res.5	-res.6
Normally open with TTL drive		RTN	Vcc	E1	E2	E3	E4	E5	E6	NC	NC	NC	NC	NC	NC	NC

NC stand for "Not Connected"
Pin R : Reset all paths
Ways 3 and 6 are not connected for SP4T

PAGE 8/8

ISSUE 09-02-18

SERIES SPnT

PART NUMBER R591 XXX XXX

POWER RATING CHART

This graph is based on the following conditions :

- Ambient temperature : + 25°C
- Sea level
- V.S.W.R. : 1 and cold switching

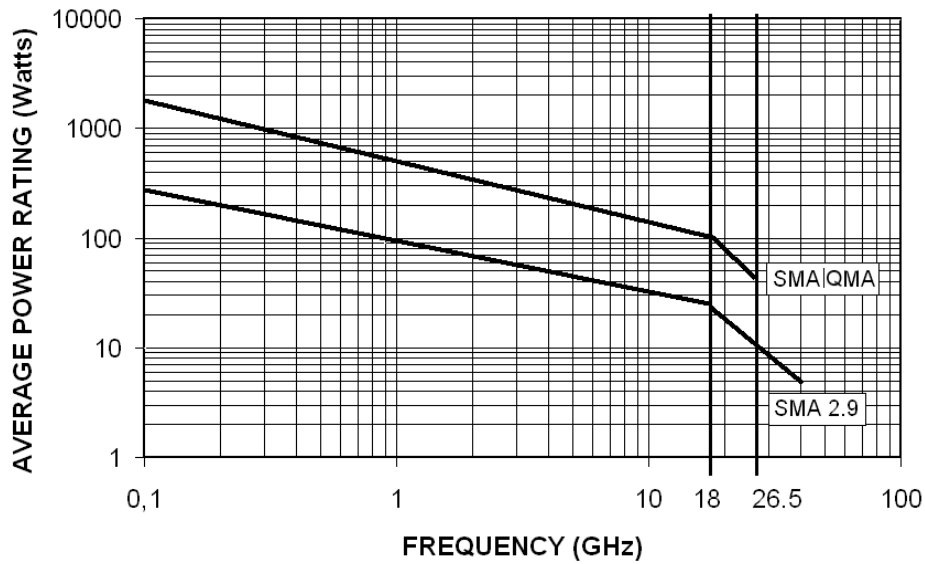
DERATING FACTOR VERSUS V.S.W.R.

The average power input must be reduced for load V.S.W.R. above 1.

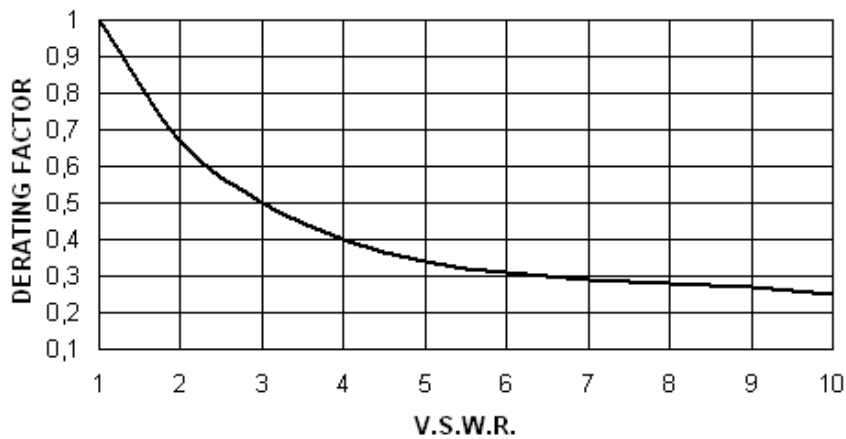

OUR CERTIFICATE

DiGi provide top-quality products and perfect service for customer worldwide through standardization, technological innovation and continuous improvement. DiGi through third-party certification, we stricly control the quality of products and services. Welcome your RFQ to

Email: Info@DiGi-Electronics.com



Tel: +00 852-30501935

RFQ Email: Info@DiGi-Electronics.com

DiGi is a global authorized distributor of electronic components.