

551MILFT Datasheet

www.digi-electronics.com

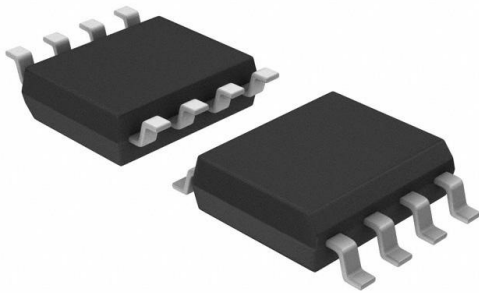

<https://www.DiGi-Electronics.com>

DiGi Electronics Part Number	551MILFT-DG
Manufacturer	Renesas Electronics Corporation
Manufacturer Product Number	551MILFT
Description	IC CLK BUFFER 1:4 160MHZ 8SOIC
Detailed Description	Clock Fanout Buffer (Distribution) IC 1:4 160 MHz 8-SOIC (0.154", 3.90mm Width)



Tel: +00 852-30501935

RFQ Email: Info@DiGi-Electronics.com

DiGi is a global authorized distributor of electronic components.

Purchase and inquiry

Manufacturer Product Number:

551MILFT

Series:

ClockBlocks™

Type:

Fanout Buffer (Distribution)

Ratio - Input:Output:

1:4

Input:

CMOS

Frequency - Max:

160 MHz

Operating Temperature:

-40°C ~ 85°C

Package / Case:

8-SOIC (0.154", 3.90mm Width)

Base Product Number:

551M

Manufacturer:

Renesas Electronics Corporation

Product Status:

Active

Number of Circuits:

1

Differential - Input:Output:

No/No

Output:

CMOS

Voltage - Supply:

3V ~ 5.5V

Mounting Type:

Surface Mount

Supplier Device Package:

8-SOIC

Environmental & Export classification

RoHS Status:

ROHS3 Compliant

REACH Status:

REACH Unaffected

HTSUS:

8542.39.0001

Moisture Sensitivity Level (MSL):

1 (Unlimited)

ECCN:

EAR99



1 TO 4 CLOCK BUFFER

ICS551

Description

The ICS551 is a low cost, high-speed single input to four output clock buffer. Part of IDT's ClockBlocks™ family, this is our lowest cost, small clock buffer.

See the ICS552-02B for monolithic dual version of the ICS551 in a 20 pin QSOP.

IDT makes many non-PLL and PLL based low skew output devices as well as Zero Delay Buffers to synchronize clocks. Contact IDT for all of your clocking needs.

Features

- Low skew (250 ps) outputs
- Pb-free packaging
- Low cost clock buffer
- Packaged in 8-pin SOIC
- Input/Output clock frequency up to 160 MHz
- Non-inverting output clock
- Ideal for networking clocks
- Operating Voltages of 3.3 and 5.0 V
- Output Enable mode tri-states outputs
- Advanced, low power CMOS process
- Commercial and industrial temperature versions

Block Diagram

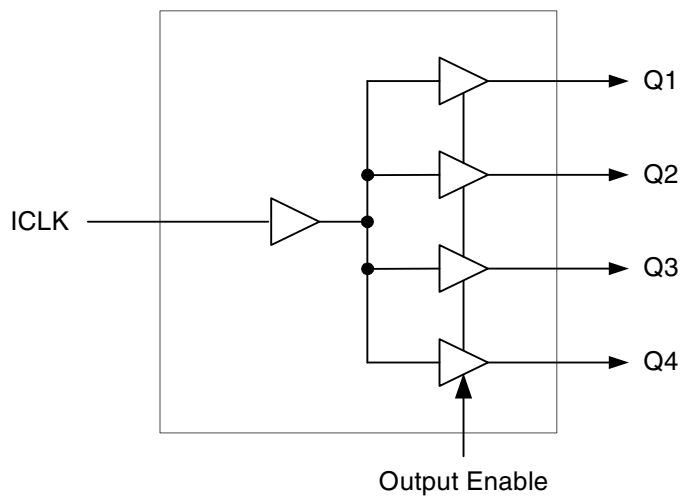

Pin Assignment

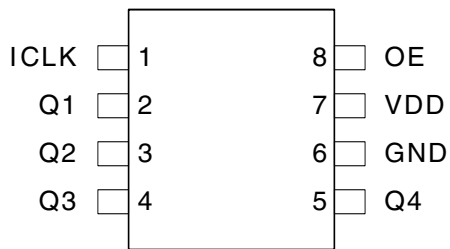

8 Pin (150 mil) SOIC

Pin Descriptions

Pin Number	Pin Name	Pin Type	Pin Description
1	ICLK	Input	Clock input. Internal pull-up resistor.
2	Q1	Output	Clock output 1.
3	Q2	Output	Clock output 2.
4	Q3	Output	Clock output 3.
5	Q4	Output	Clock output 4.
6	GND	Power	Connect to ground.
7	VDD	Power	Connect to 3.3 V or 5.0 V.
8	OE	Input	Output Enable. Tri-states outputs when low. Internal pull-up resistor.

External Components

A minimum number of external components are required for proper operation. A decoupling capacitor of 0.01 μ F should be connected between VDD on pin 7 and GND on pin 6, as close to the device as possible. A 33 Ω series terminating resistor may be used on each clock output if the trace is longer than 1 inch.

Absolute Maximum Ratings

Stresses above the ratings listed below can cause permanent damage to the ICS551. These ratings, which are standard values for IDT commercially rated parts, are stress ratings only. Functional operation of the device at these or any other conditions above those indicated in the operational sections of the specifications is not implied. Exposure to absolute maximum rating conditions for extended periods can affect product reliability. Electrical parameters are guaranteed only over the recommended operating temperature range.

Item	Rating
Supply Voltage, VDD	7 V
All Inputs and Outputs	-0.5 V to VDD+0.5 V
Ambient Operating Temperature, Commercial	0 to +70° C
Ambient Operating Temperature, Industrial	-40 to +85° C
Storage Temperature	-65 to +150° C
Junction Temperature	125° C
Soldering Temperature	260° C

Recommended Operation Conditions

Parameter	Min.	Typ.	Max.	Units
Ambient Operating Temperature	-40	–	+85	°C
Power Supply Voltage (measured in respect to GND)	+3.0		+5.5	V

DC Electrical Characteristics

VDD=3.3 V ±10% , Ambient temperature -40 to +85 °C, unless stated otherwise

Parameter	Symbol	Conditions	Min.	Typ.	Max.	Units
Operating Voltage	VDD		3.0		3.6	V
Input High Voltage, ICLK	V _{IH}	Note 1	VDD/2+0.7		3.8	V
Input Low Voltage, ICLK	V _{IL}	Note 1			VDD/2-0.7	V
Input High Voltage, OE	V _{IH}		2		VDD	V
Input Low Voltage, OE	V _{IL}				0.8	V
Output High Voltage	V _{OH}	I _{OH} = -25 mA	2.4			V
Output Low Voltage	V _{OL}	I _{OL} = 25 mA			0.4	V
Output High Voltage (CMOS Level)	V _{OH}	I _{OH} = -12 mA	VDD-0.4			V
Operating Supply Current	IDD	No load, 135 MHz		18		mA
Nominal Output Impedance	Z _O			20		Ω
Internal Pull-up Resistor	R _{PU}	OE		500		kΩ
Input Capacitance	C _{IN}	OE pin		5		pF
Short Circuit Current	I _{OS}			±50		mA

VDD = 5 V ±10% , Ambient temperature -40 to +85 °C, unless stated otherwise

Parameter	Symbol	Conditions	Min.	Typ.	Max.	Units
Operating Voltage	VDD		4.5		5.5	V
Input High Voltage, ICLK	V _{IH}	Note 1	VDD/2+1		5.5	V
Input Low Voltage, ICLK	V _{IL}	Note 1			VDD/2-1	V
Input High Voltage, OE	V _{IH}		2		VDD	V
Input Low Voltage, OE	V _{IL}				0.8	V
Output High Voltage	V _{OH}	I _{OH} = -35 mA	2.4			V
Output Low Voltage	V _{OL}	I _{OL} = 35 mA			0.4	V
Output High Voltage (CMOS Level)	V _{OH}	I _{OH} = -12 mA	VDD-0.4			V
Operating Supply Current	IDD	No load, 135 MHz		35		mA
Nominal Output Impedance	Z _O			20		Ω
Internal Pull-up Resistor	R _{PU}	OE		220		kΩ
Input Capacitance	C _{IN}	OE pin		5		pF
Short Circuit Current	I _{OS}			±80		mA

Notes: 1. Nominal switching threshold is VDD/2.

AC Electrical Characteristics

VDD = 3.3 V ±10%, Ambient Temperature -40 to +85 °C, unless stated otherwise

Parameter	Symbol	Conditions	Min.	Typ.	Max.	Units
Input Frequency			0		160	MHz
Output Frequency		15 pF load, Note 4			160	MHz
Output Clock Rise Time	t _{OR}	0.8 to 2.0 V			1.0	ns
Output Clock Fall Time	t _{OF}	2.0 to 0.8 V			1.0	ns
Propagation Delay	Note 1	135 MHz	2	4	8	ns
Output to Output Skew	Note 2	Rising edges at VDD/2			250	ps

VDD = 5 V ±10%, Ambient Temperature -40 to +85 °C, unless stated otherwise

Parameter	Symbol	Conditions	Min.	Typ.	Max.	Units
Input Frequency			0		135	MHz
Output Frequency		15 pF load, Note 4			135	MHz
Output Clock Rise Time	t _{OR}	0.8 to 2.0 V			1.0	ns
Output Clock Fall Time	t _{OF}	2.0 to 0.8 V			1.0	ns
Propagation Delay	Note 1	135 MHz	1.5	3	6	ns
Output to Output Skew	Note 2	Rising edges at VDD/2			250	ps

Notes:

1. With rail to rail input clock.
2. Between any 2 outputs with equal loading.
3. Duty cycle on outputs will match incoming clock duty cycle. Consult IDT for tight duty cycle clock generators.
4. With external series resistor of 33Ω positioned close to each output pin.

Marking Diagram (ICS551MLF)

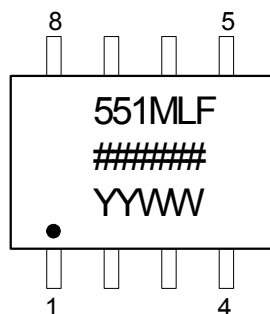

Marking Diagram (ICS551MLN)

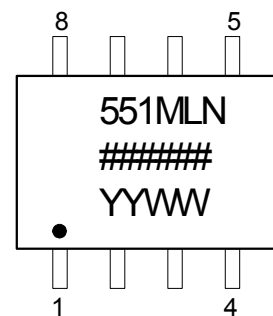

Marking Diagram (ICS551MILF)

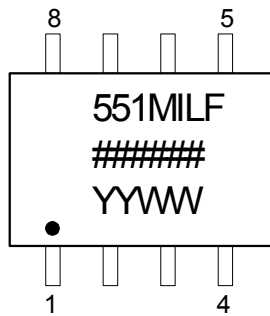

Notes:

1. ##### is the lot number.
2. YYWW is the last two digits of the year and week that the part was assembled.
3. "LF" denotes Pb (lead) free package.
4. Bottom marking: (origin)
Origin = country of origin if not USA.

ICS551

1 TO 4 CLOCK BUFFER

FAN OUT BUFFER

Package Outline and Package Dimensions (8-pin SOIC, 150 Mil. Narrow Body)

Package dimensions are kept current with JEDEC Publication No. 95

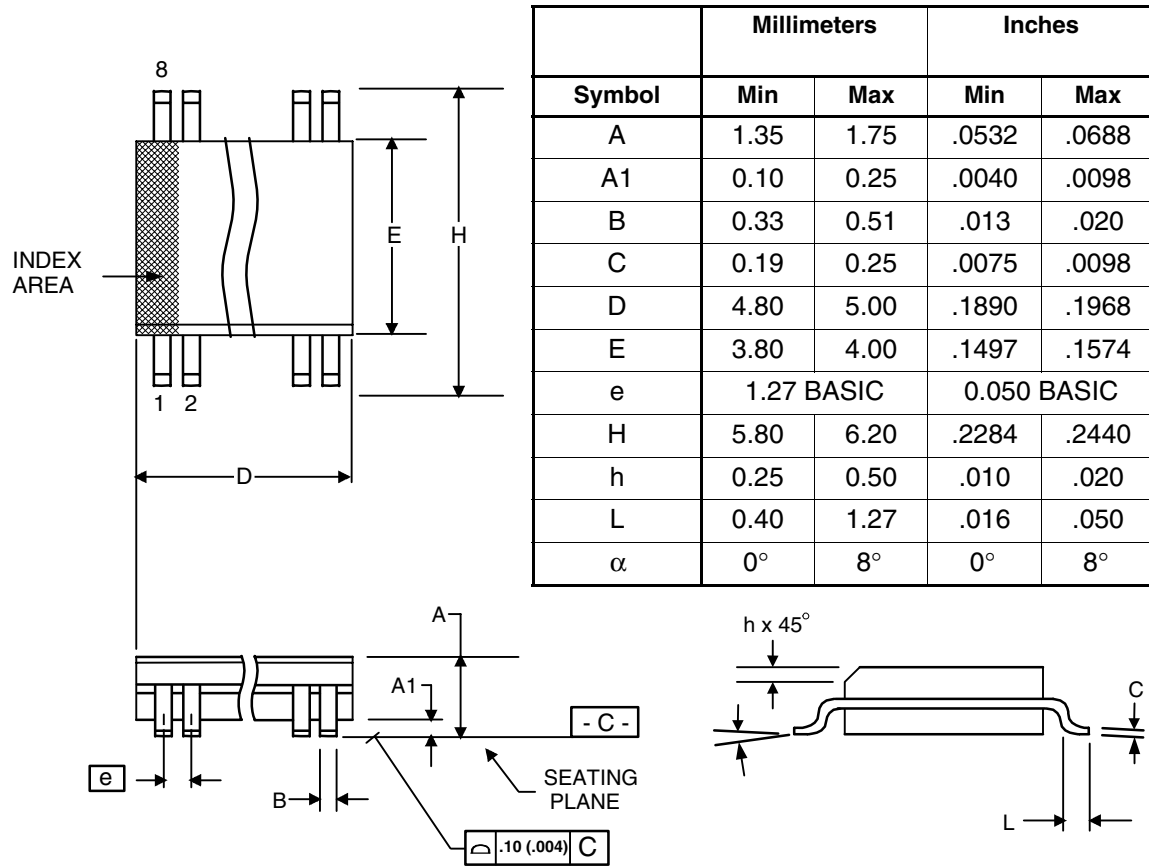

Ordering Information

Part / Order Number	Marking	Shipping Packaging	Package	Temperature
551MLF	551MLF	Tubes	8-pin SOIC	0 to +70 °C
551MLFT	551MLF	Tape and Reel	8-pin SOIC	0 to +70 °C
551MLN	551MLN	Tubes	8-pin SOIC	0 to +70 °C
551MLNT	551MLN	Tape and Reel	8-pin SOIC	0 to +70 °C
551MILF	551MILF	Tubes	8-pin SOIC	-40 to +85 °C
551MILFT	551MILF	Tape and Reel	8-pin SOIC	-40 to +85 °C

"LF" suffix to the part number are the Pb-Free configuration and are RoHS compliant.

"LN" denotes parts that are Pb free and annealed.

While the information presented herein has been checked for both accuracy and reliability, Integrated Device Technology (IDT) assumes no responsibility for either its use or for the infringement of any patents or other rights of third parties, which would result from its use. No other circuits, patents, or licenses are implied. This product is intended for use in normal commercial applications. Any other applications such as those requiring extended temperature range, high reliability, or other extraordinary environmental requirements are not recommended without additional processing by IDT. IDT reserves the right to change any circuitry or specifications without notice. IDT does not authorize or warrant any IDT product for use in life support devices or critical medical instruments.

ICS551

1 TO 4 CLOCK BUFFER

FAN OUT BUFFER

IMPORTANT NOTICE AND DISCLAIMER

RENESAS ELECTRONICS CORPORATION AND ITS SUBSIDIARIES (“RENESAS”) PROVIDES TECHNICAL SPECIFICATIONS AND RELIABILITY DATA (INCLUDING DATASHEETS), DESIGN RESOURCES (INCLUDING REFERENCE DESIGNS), APPLICATION OR OTHER DESIGN ADVICE, WEB TOOLS, SAFETY INFORMATION, AND OTHER RESOURCES “AS IS” AND WITH ALL FAULTS, AND DISCLAIMS ALL WARRANTIES, EXPRESS OR IMPLIED, INCLUDING, WITHOUT LIMITATION, ANY IMPLIED WARRANTIES OF MERCHANTABILITY, FITNESS FOR A PARTICULAR PURPOSE, OR NON-INFRINGEMENT OF THIRD-PARTY INTELLECTUAL PROPERTY RIGHTS.

These resources are intended for developers who are designing with Renesas products. You are solely responsible for (1) selecting the appropriate products for your application, (2) designing, validating, and testing your application, and (3) ensuring your application meets applicable standards, and any other safety, security, or other requirements. These resources are subject to change without notice. Renesas grants you permission to use these resources only to develop an application that uses Renesas products. Other reproduction or use of these resources is strictly prohibited. No license is granted to any other Renesas intellectual property or to any third-party intellectual property. Renesas disclaims responsibility for, and you will fully indemnify Renesas and its representatives against, any claims, damages, costs, losses, or liabilities arising from your use of these resources. Renesas' products are provided only subject to Renesas' Terms and Conditions of Sale or other applicable terms agreed to in writing. No use of any Renesas resources expands or otherwise alters any applicable warranties or warranty disclaimers for these products.

(Disclaimer Rev.1.01)

Corporate Headquarters

TOYOSU FORESIA, 3-2-24 Toyosu,
Koto-ku, Tokyo 135-0061, Japan
www.renesas.com

Trademarks

Renesas and the Renesas logo are trademarks of Renesas Electronics Corporation. All trademarks and registered trademarks are the property of their respective owners.

Contact Information

For further information on a product, technology, the most up-to-date version of a document, or your nearest sales office, please visit www.renesas.com/contact-us/.

OUR CERTIFICATE

DiGi provide top-quality products and perfect service for customer worldwide through standardization, technological innovation and continuous improvement. DiGi through third-party certification, we stricly control the quality of products and services. Welcome your RFQ to

Email: Info@DiGi-Electronics.com



Tel: +00 852-30501935

RFQ Email: Info@DiGi-Electronics.com

DiGi is a global authorized distributor of electronic components.