

EL5444CS-T7 Datasheet

www.digi-electronics.com

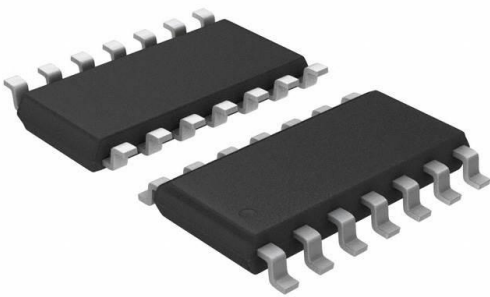

DiGi Electronics Part Number	EL5444CS-T7-DG
Manufacturer	Renesas Electronics Corporation
Manufacturer Product Number	EL5444CS-T7
Description	IC OPAMP VFB 4 CIRCUIT 14SOIC
Detailed Description	Voltage Feedback Amplifier 4 Circuit Rail-to-Rail 14-SOIC

<https://www.DiGi-Electronics.com>



Tel: +00 852-30501935

RFQ Email: Info@DiGi-Electronics.com

DiGi is a global authorized distributor of electronic components.

Purchase and inquiry

Manufacturer Product Number:

EL5444CS-T7

Series:

-

Amplifier Type:

Voltage Feedback

Output Type:

Rail-to-Rail

Gain Bandwidth Product:

60 MHz

Current - Input Bias:

2 nA

Current - Supply:

7mA (x4 Channels)

Voltage - Supply Span (Min):

4.75 V

Operating Temperature:

-40°C ~ 85°C

Package / Case:

14-SOIC (0.154", 3.90mm Width)

Base Product Number:

EL5444

Manufacturer:

Renesas Electronics Corporation

Product Status:

Obsolete

Number of Circuits:

4

Slew Rate:

200V/ μ s

-3db Bandwidth:

100 MHz

Voltage - Input Offset:

25 mV

Current - Output / Channel:

120 mA

Voltage - Supply Span (Max):

5.25 V

Mounting Type:

Surface Mount

Supplier Device Package:

14-SOIC

Environmental & Export classification

RoHS Status:

RoHS non-compliant

REACH Status:

REACH Unaffected

HTSUS:

8542.33.0001

Moisture Sensitivity Level (MSL):

1 (Unlimited)

ECCN:

EAR99



100MHz Single-Supply Rail-to-Rail Amplifiers

The EL5144 series amplifiers are voltage-feedback, high speed, rail-to-rail amplifiers designed to operate on a single +5V supply. They offer unity gain stability with an unloaded -3dB bandwidth of 100MHz. The input common-mode voltage range extends from the negative rail to within 1.5V of the positive rail. Driving a 75Ω double terminated coaxial cable, the EL5144 series amplifiers drive to within 150mV of either rail. The 200V/μs slew rate and 0.1%/0.1° differential gain/differential phase makes these parts ideal for composite and component video applications. With their voltage-feedback architecture, these amplifiers can accept reactive feedback networks, allowing them to be used in analog filtering applications. These amplifiers will source 90mA and sink 65mA.

The EL5146 and EL5246 have a power-savings disable feature. Applying a standard TTL low logic level to the CE (Chip Enable) pin reduces the supply current to 2.6μA within 10ns. Turn-on time is 500ns, allowing true break-before-make conditions for multiplexing applications. Allowing the CE pin to float or applying a high logic level will enable the amplifier.

For applications where board space is critical, singles are offered in a 5-pin SOT-23 package, duals in 8- and 10-pin MSOP packages, and quads in a 16-pin QSOP package. Singles, duals, and quads are also available in industry-standard pinouts in SO and PDIP packages. All parts operate over the industrial temperature range of -40°C to +85°C.

Features

- Rail-to-rail output swing
- -3dB bandwidth = 100MHz
- Single-supply +5V operation
- Power-down to 2.6μA
- Large input common-mode range $0V < V_{CM} < 3.5V$
- Diff gain/phase = 0.1%/0.1°
- Low power 35mW per amplifier
- Space-saving SOT23-5, MSOP8 & 10, & QSOP16 packages
- Pb-Free available (RoHS compliant)

Applications

- Video amplifiers
- 5V analog signal processing
- Multiplexers
- Line drivers
- Portable computers
- High speed communications
- Sample & hold amplifiers
- Comparators

EL5144, EL5146, EL5244, EL5246, EL5444**Ordering Information**

PART NUMBER	PACKAGE	TAPE & REEL	PKG. DWG. #
EL5144CW-T7	5-Pin SOT-23*	7" (3K pcs)	MDP0038
EL5144CW-T7A	5-Pin SOT-23*	7" (250 pcs)	MDP0038
EL5144CWZ-T7 (See Note)	5-Pin SOT-23* (Pb-free)	7" (3K pcs)	MDP0038
EL5144CWZ-T7A (See Note)	5-Pin SOT-23* (Pb-free)	7" (250 pcs)	MDP0038
EL5146CN	8-Pin PDIP	-	MDP0031
EL5146CS	8-Pin SOIC	-	MDP0027
EL5146CS-T7	8-Pin SOIC	7"	MDP0027
EL5146CS-T13	8-Pin SOIC	13"	MDP0027
EL5146CSZ (See Note)	8-Pin SOIC (Pb-free)	-	MDP0027
EL5146CSZ-T7 (See Note)	8-Pin SOIC (Pb-free)	7"	MDP0027
EL5146CSZ-T13 (See Note)	8-Pin SOIC (Pb-free)	13"	MDP0027
EL5244CN	8-Pin PDIP	-	MDP0031
EL5244CS	8-Pin SOIC	-	MDP0027
EL5244CS-T7	8-Pin SOIC	7"	MDP0027
EL5244CS-T13	8-Pin SOIC	13"	MDP0027
EL5244CSZ (See Note)	8-Pin SOIC (Pb-free)	-	MDP0027
EL5244CSZ-T7 (See Note)	8-Pin SOIC (Pb-free)	7"	MDP0027
EL5244CSZ-T13 (See Note)	8-Pin SOIC (Pb-free)	13"	MDP0027
EL5244CY	8-Pin MSOP	-	MDP0043
EL5244CY-T13	8-Pin MSOP	13"	MDP0043
EL5244CYZ (See Note)	8-Pin MSOP (Pb-free)	-	MDP0043
EL5244CYZ-T7 (See Note)	8-Pin MSOP (Pb-free)	7"	MDP0043
EL5244CYZ-T13 (See Note)	8-Pin MSOP (Pb-free)	13"	MDP0043
EL5246CN	14-Pin PDIP	-	MDP0031
EL5246CS	14-Pin SOIC	-	MDP0027
EL5246CS-T7	14-Pin SOIC	7"	MDP0027
EL5246CS-T13	14-Pin SOIC	13"	MDP0027
EL5246CSZ (See Note)	14-Pin SOIC (Pb-free)	-	MDP0027
EL5246CSZ-T7 (See Note)	14-Pin SOIC (Pb-free)	7"	MDP0027
EL5246CSZ-T13 (See Note)	14-Pin SOIC (Pb-free)	13"	MDP0027
EL5246CY	10-Pin MSOP	-	MDP0043
EL5246CY-T13	10-Pin MSOP	13"	MDP0043

Ordering Information (Continued)

PART NUMBER	PACKAGE	TAPE & REEL	PKG. DWG. #
EL5246CYZ (See Note)	10-Pin MSOP (Pb-free)	-	MDP0043
EL5246CYZ-T7 (See Note)	10-Pin MSOP (Pb-free)	7"	MDP0043
EL5246CYZ-T13 (See Note)	10-Pin MSOP (Pb-free)	13"	MDP0043
EL5444CN	14-Pin PDIP	-	MDP0031
EL5444CS	14-Pin SOIC	-	MDP0027
EL5444CS-T7	14-Pin SOIC	7"	MDP0027
EL5444CS-T13	14-Pin SOIC	13"	MDP0027
EL5444CSZ (See Note)	14-Pin SOIC (Pb-free)	-	MDP0027
EL5444CSZ-T7 (See Note)	14-Pin SOIC (Pb-free)	7"	MDP0027
EL5444CSZ-T13 (See Note)	14-Pin SOIC (Pb-free)	13"	MDP0027
EL5444CU	16-Pin QSOP	-	MDP0040
EL5444CU-T13	16-Pin QSOP	13"	MDP0040
EL5444CUZ (See Note)	16-Pin QSOP (Pb-free)	-	MDP0040
EL5444CUZ-T7 (See Note)	16-Pin QSOP (Pb-free)	7"	MDP0040
EL5444CUZ-T13 (See Note)	16-Pin QSOP (Pb-free)	13"	MDP0040

*EL5144CW symbol is .Jxxx where xxx represents date

NOTE: Intersil Pb-free products employ special Pb-free material sets; molding compounds/die attach materials and 100% matte tin plate termination finish, which are RoHS compliant and compatible with both SnPb and Pb-free soldering operations. Intersil Pb-free products are MSL classified at Pb-free peak reflow temperatures that meet or exceed the Pb-free requirements of IPC/JEDEC J STD-020.

EL5144, EL5146, EL5244, EL5246, EL5444

Pinouts

EL5144
(5-PIN SOT-23)
TOP VIEW

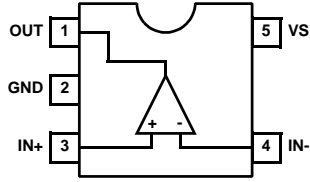

EL5146 & EL5146
(8-PIN SO, PDIP)
TOP VIEW

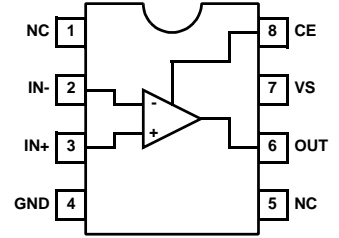

EL5244
(8-PIN SOIC, PDIP, MSOP)
TOP VIEW

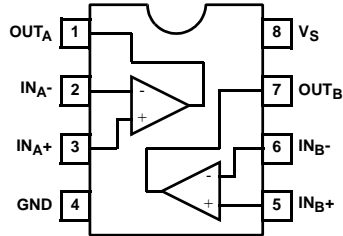

EL5246
(10-PIN MSOP)
TOP VIEW

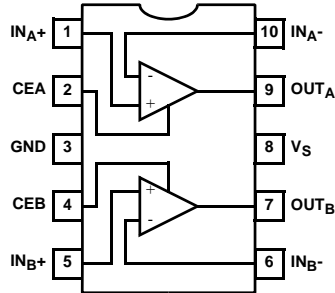

EL5246
(14-PIN SOIC, PDIP)
TOP VIEW

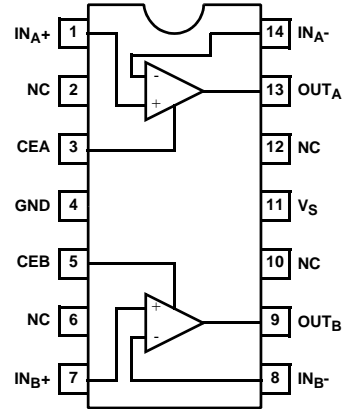

EL5444
(14-PIN SOIC, PDIP)
TOP VIEW

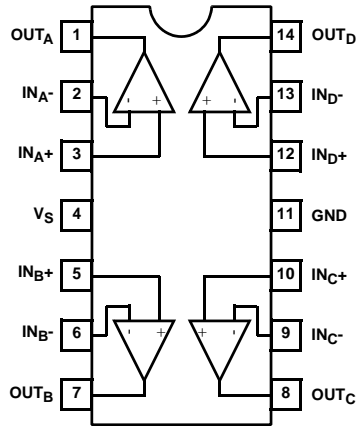

EL5444
(16-PIN QSOP)
TOP VIEW

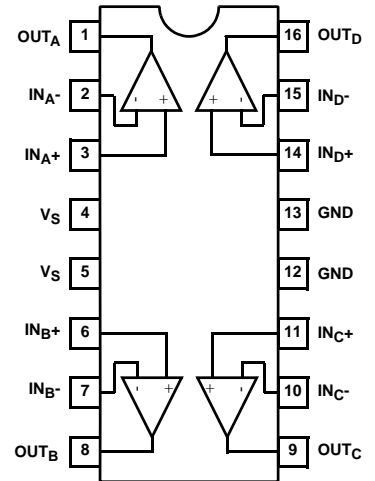

EL5144, EL5146, EL5244, EL5246, EL5444**Absolute Maximum Ratings** ($T_A = 25^\circ\text{C}$)

Supply Voltage between V_S and GND+6V	Pin Voltages GND -0.5V to V_S +0.5V
Maximum Continuous Output Current 50mA	Storage Temperature-65°C to +150°C
Power Dissipation See Curves	Operating Temperature-40°C to +85°C

CAUTION: Stresses above those listed in "Absolute Maximum Ratings" may cause permanent damage to the device. This is a stress only rating and operation of the device at these or any other conditions above those indicated in the operational sections of this specification is not implied.

IMPORTANT NOTE: All parameters having Min/Max specifications are guaranteed. Typical values are for information purposes only. Unless otherwise noted, all tests are at the specified temperature and are pulsed tests, therefore: $T_J = T_C = T_A$

Electrical Specifications $V_S = +5\text{V}$, $\text{GND} = 0\text{V}$, $T_A = 25^\circ\text{C}$, $\text{CE} = +2\text{V}$, unless otherwise specified.

PARAMETER	DESCRIPTION	CONDITIONS	MIN	TYP	MAX	UNIT
AC PERFORMANCE						
d_G	Differential Gain Error (Note 1)	$G = 2$, $R_L = 150\Omega$ to 2.5V, $R_F = 1\text{k}\Omega$		0.1		%
d_P	Differential Phase Error (Note 1)	$G = 2$, $R_L = 150\Omega$ to 2.5V, $R_F = 1\text{k}\Omega$		0.1		°
BW	Bandwidth	-3dB, $G = 1$, $R_L = 10\text{k}\Omega$, $R_F = 0$		100		MHz
		-3dB, $G = 1$, $R_L = 150\Omega$, $R_F = 0$		60		MHz
BW1	Bandwidth	$\pm 0.1\text{dB}$, $G = 1$, $R_L = 150\Omega$ to GND, $R_F = 0$		8		MHz
GBWP	Gain Bandwidth Product			60		MHz
SR	Slew Rate	$G = 1$, $R_L = 150\Omega$ to GND, $R_F = 0$, $V_O = 0.5\text{V}$ to 3.5V	150	200		V/ μs
t_s	Settling Time	to 0.1%, $V_{OUT} = 0\text{V}$ to 3V		35		ns
DC PERFORMANCE						
A_{VOL}	Open Loop Voltage Gain	$R_L = \text{no load}$, $V_{OUT} = 0.5\text{V}$ to 3V	54	65		dB
		$R_L = 150\Omega$ to GND, $V_{OUT} = 0.5\text{V}$ to 3V	40	50		dB
V_{OS}	Offset Voltage	$V_{CM} = 1\text{V}$, SOT23-5 and MSOP packages			25	mV
		$V_{CM} = 1\text{V}$, All other packages			15	mV
$T_{C}V_{OS}$	Input Offset Voltage Temperature Coefficient			10		mV/ $^\circ\text{C}$
I_B	Input Bias Current	$V_{CM} = 0\text{V}$ & 3.5V		2	100	nA
INPUT CHARACTERISTICS						
CMIR	Common Mode Input Range	$\text{CMRR} \geq 47\text{dB}$	0		3.5	V
CMRR	Common Mode Rejection Ratio	DC, $V_{CM} = 0$ to 3.0V	50	60		dB
		DC, $V_{CM} = 0$ to 3.5V	47	60		dB
R_{IN}	Input Resistance			1.5		$\text{G}\Omega$
C_{IN}	Input Capacitance			1.5		pF
OUTPUT CHARACTERISTICS						
V_{OP}	Positive Output Voltage Swing	$R_L = 150\Omega$ to 2.5V (Note 2)	4.70	4.85		V
		$R_L = 150\Omega$ to GND (Note 2)	4.20	4.65		V
		$R_L = 1\text{k}\Omega$ to 2.5V (Note 2)	4.95	4.97		V
V_{ON}	Negative Output Voltage Swing	$R_L = 150\Omega$ to 2.5V (Note 2)		0.15	0.30	V
		$R_L = 150\Omega$ to GND (Note 2)		0		V
		$R_L = 1\text{k}\Omega$ to 2.5V (Note 2)		0.03	0.05	V
$+I_{OUT}$	Positive Output Current	$R_L = 10\Omega$ to 2.5V	60	90	120	mA
$-I_{OUT}$	Negative Output Current	$R_L = 10\Omega$ to 2.5V	-50	-65	-80	mA
ENABLE (EL5146 & EL5246 ONLY)						

EL5144, EL5146, EL5244, EL5246, EL5444**Electrical Specifications** $V_S = +5V$, $GND = 0V$, $T_A = 25^\circ C$, $CE = +2V$, unless otherwise specified. (Continued)

PARAMETER	DESCRIPTION	CONDITIONS	MIN	TYP	MAX	UNIT
t_{EN}	Enable Time	EL5146, EL5246		500		ns
t_{DIS}	Disable Time	EL5146, EL5246		10		ns
I_{IHCE}	CE pin Input High Current	$CE = 5V$, EL5146, EL5246		0.003	1	mA
I_{ILCE}	CE pin Input Low Current	$CE = 0V$, EL5146, EL5246		-1.2	-3	mA
V_{IHCE}	CE pin Input High Voltage for Power Up	EL5146, EL5246	2.0			V
V_{ILCE}	CE pin Input Low Voltage for Power Down	EL5146, EL5246			0.8	V
SUPPLY						
I_{SON}	Supply Current - Enabled (per amplifier)	No load, $V_{IN} = 0V$, $CE = 5V$		7	8.8	mA
I_{SOFF}	Supply Current - Disabled (per amplifier)	No load, $V_{IN} = 0V$, $CE = 0V$		2.6	5	mA
PSOR	Power Supply Operating Range		4.75	5.0	5.25	V
PSRR	Power Supply Rejection Ratio	DC, $V_S = 4.75V$ to $5.25V$	50	60		dB

NOTES:

- Standard NTSC test, AC signal amplitude = $286mV_{P-P}$, $f = 3.8MHz$, V_{OUT} is swept from 0.8V to 3.4V, R_L is DC-coupled.
- R_L is total load resistance due to feedback resistor and load resistor.

EL5144, EL5146, EL5244, EL5246, EL5444

Typical Performance Curves

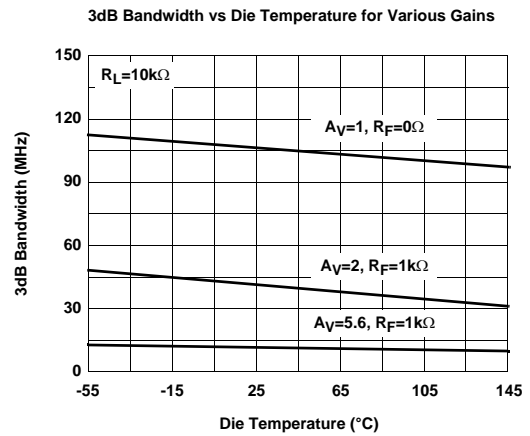
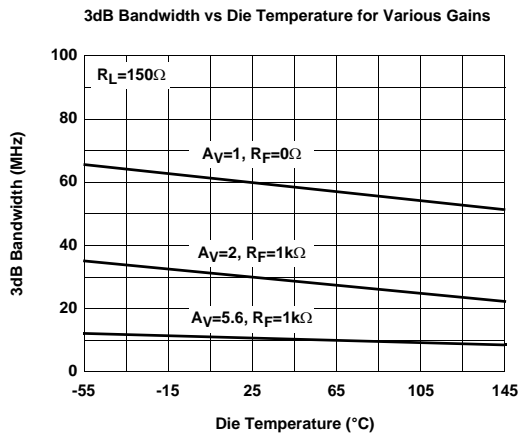
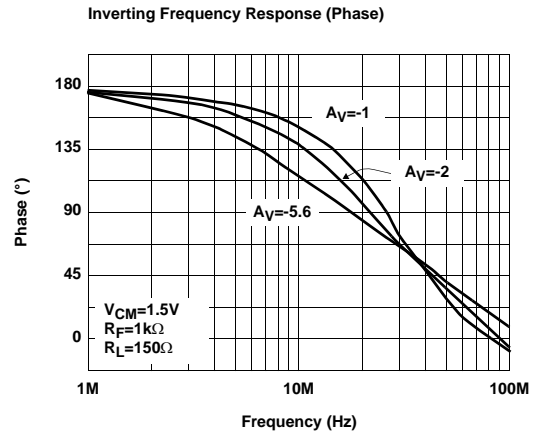
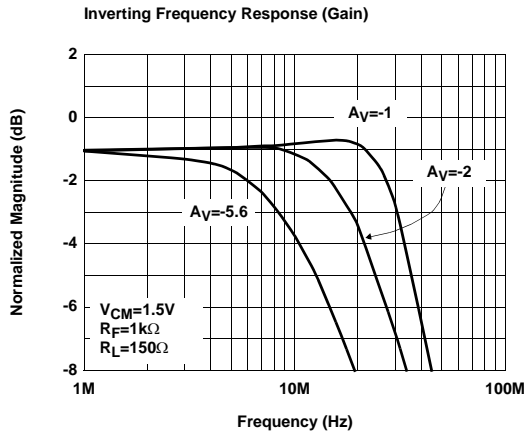
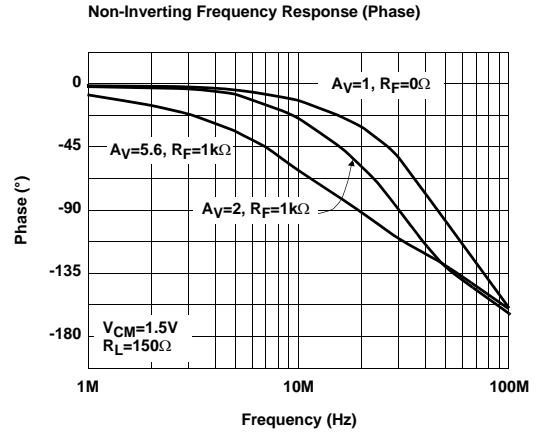
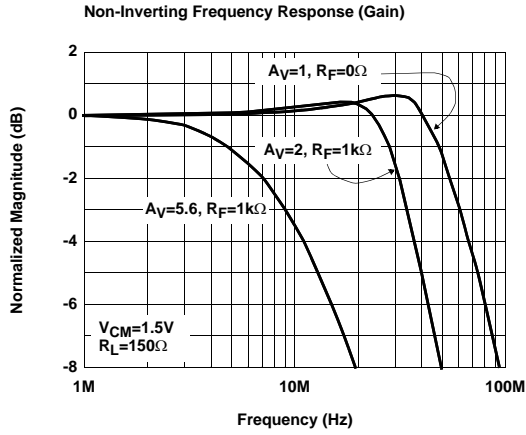

EL5144, EL5146, EL5244, EL5246, EL5444

Typical Performance Curves (Continued)

Frequency Response for Various R_L

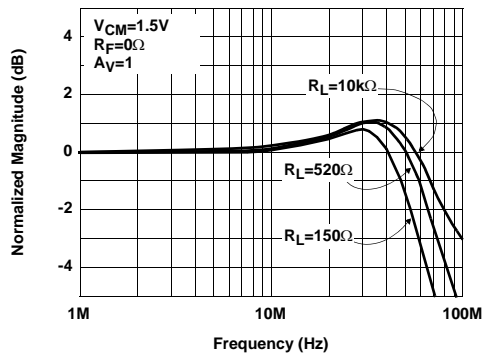

Frequency Response for Various C_L

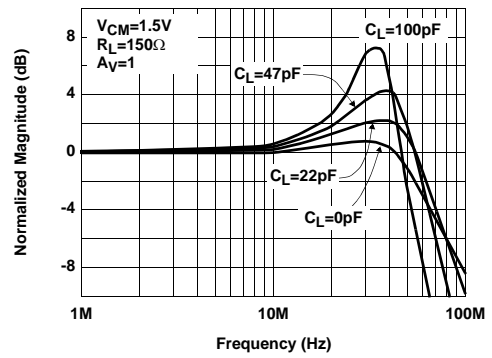

Frequency Response for Various R_F and R_G

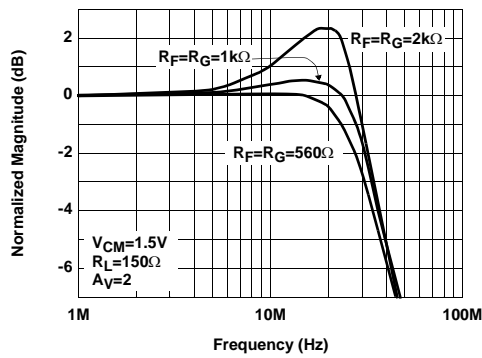

Group Delay vs Frequency

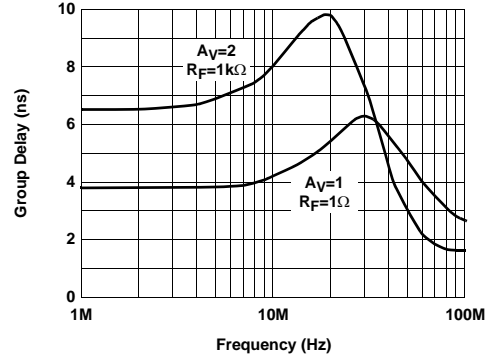

Open Loop Gain and Phase vs Frequency

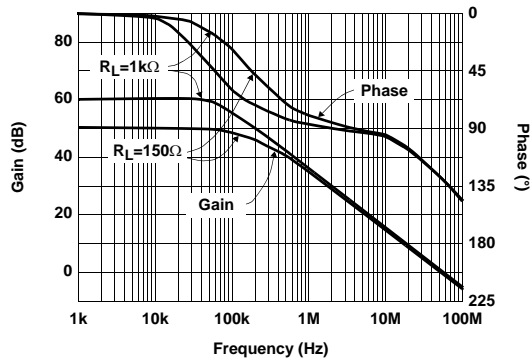

Open Loop Voltage Gain vs Die Temperature

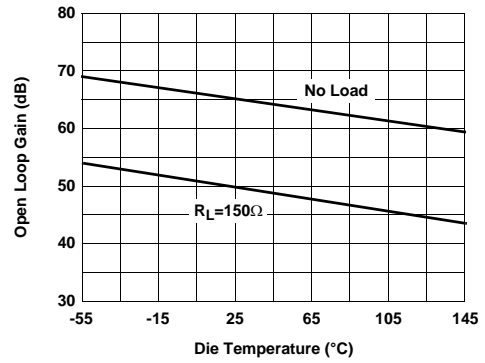

EL5144, EL5146, EL5244, EL5246, EL5444

Typical Performance Curves (Continued)

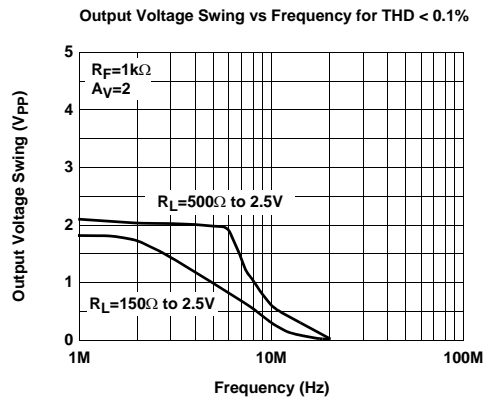
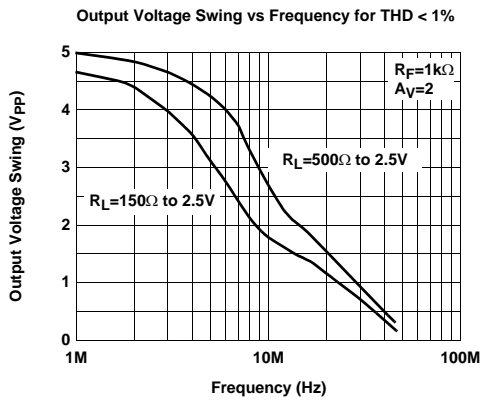
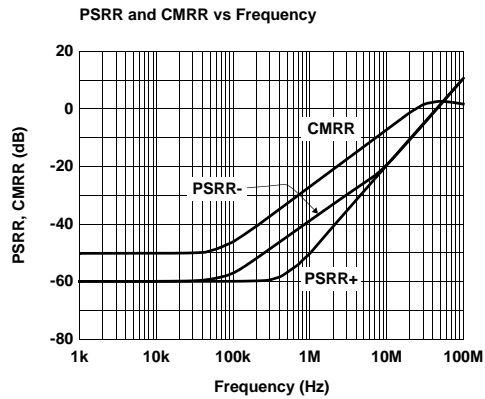
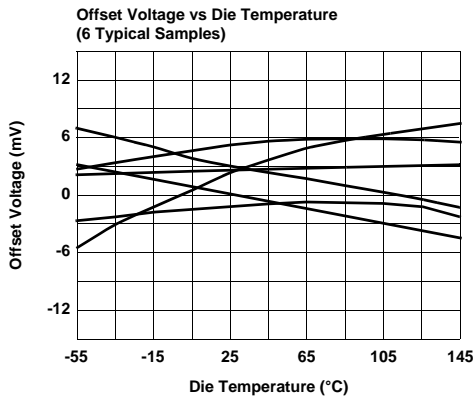
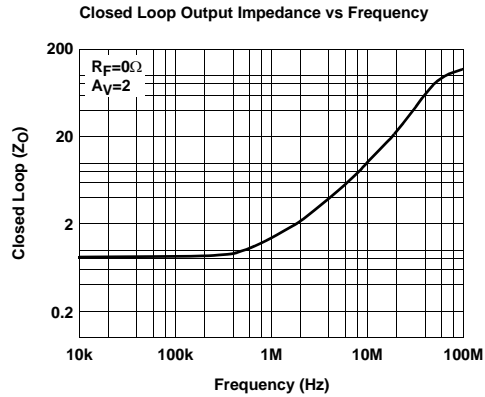
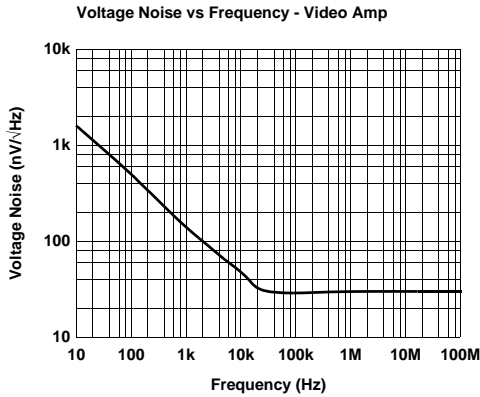

EL5144, EL5146, EL5244, EL5246, EL5444

Typical Performance Curves (Continued)

Large Signal Pulse Response (Single Supply)

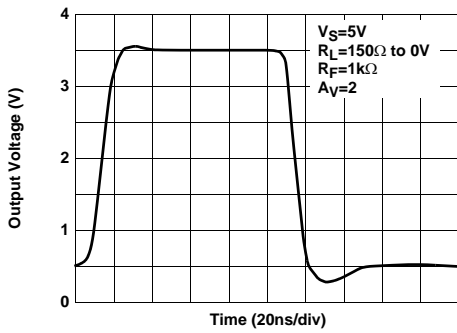

Small Signal Pulse Response (Single Supply)

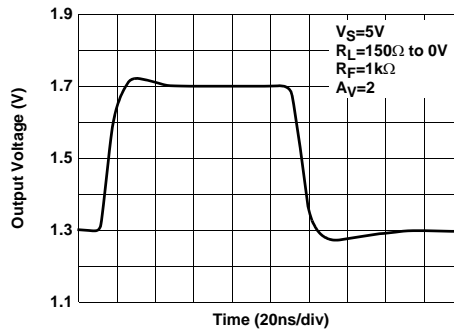

Large Signal Pulse Response (Split Supplies)

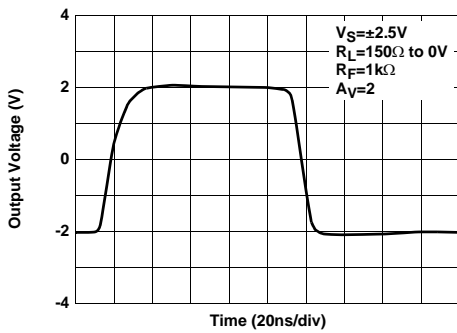

Small Signal Pulse Response (Split Supply)

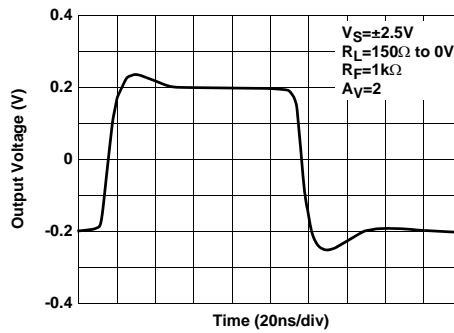

Settling Time vs Settling Accuracy

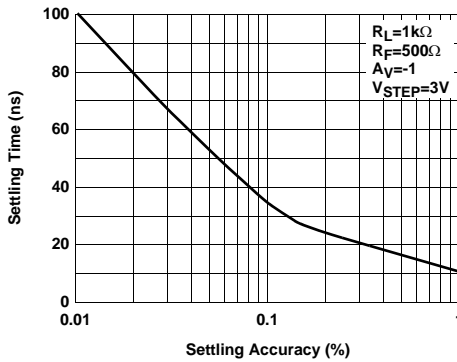

Slew Rate vs Die Temperature

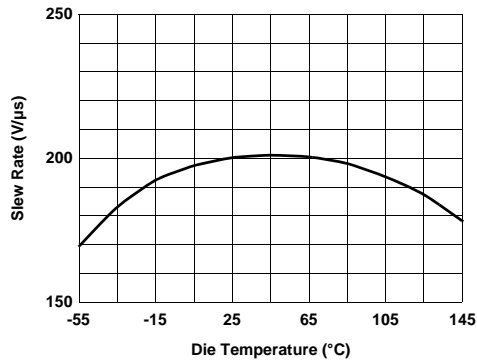

EL5144, EL5146, EL5244, EL5246, EL5444

Typical Performance Curves (Continued)

Differential Gain for R_L Tied to 0V

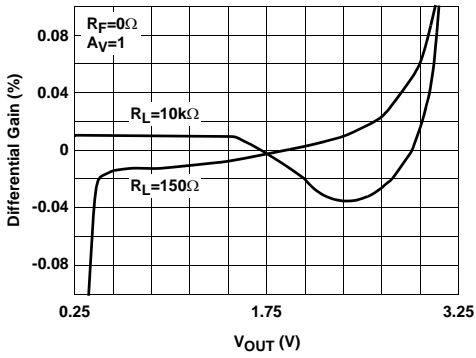

Differential Phase for R_L Tied to 0V

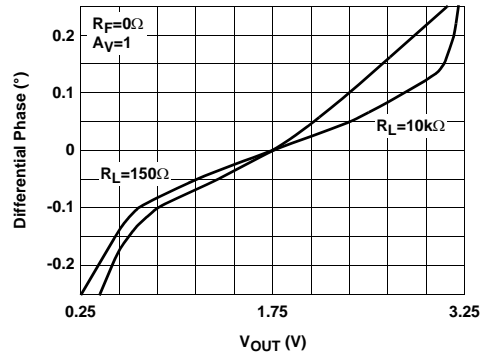

Differential Gain for R_L Tied to 2.5V

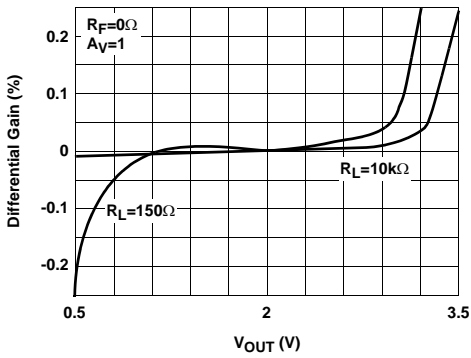

Differential Phase for R_L Tied to 2.5V

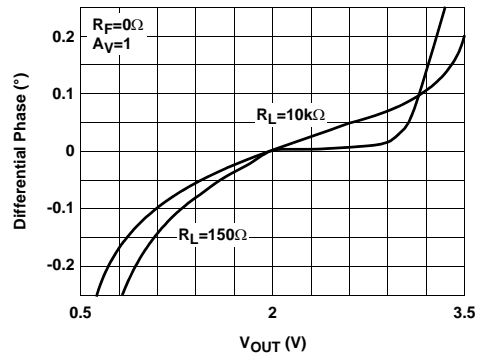

Differential Gain for R_L Tied to 0V

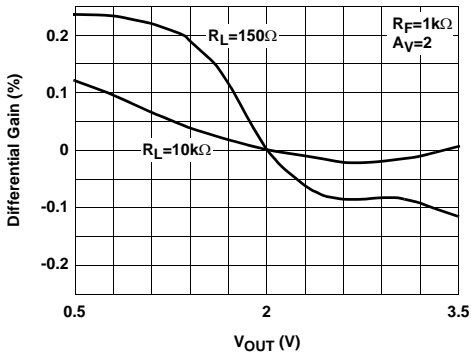

Differential Phase for R_L Tied to 0V

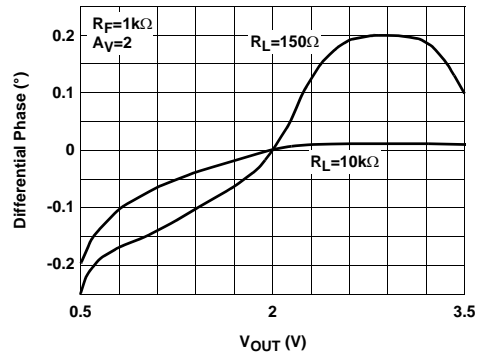

EL5144, EL5146, EL5244, EL5246, EL5444

Typical Performance Curves (Continued)

Differential Gain for R_L Tied to 2.5V

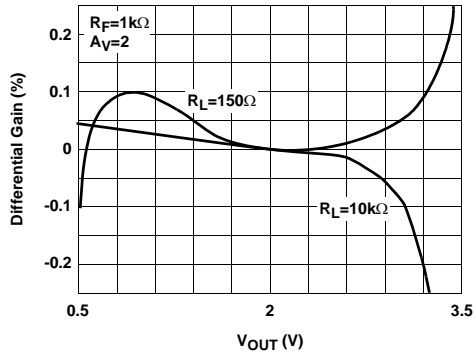

Differential Phase for R_L Tied to 2.5V

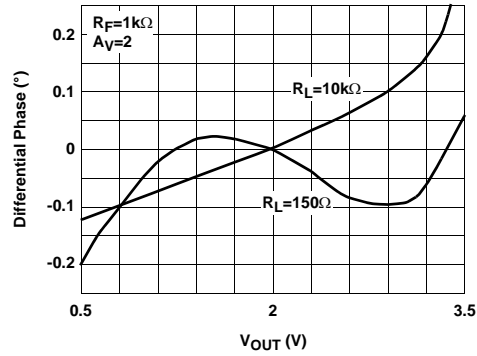

2nd and 3rd Harmonic Distortion vs Frequency

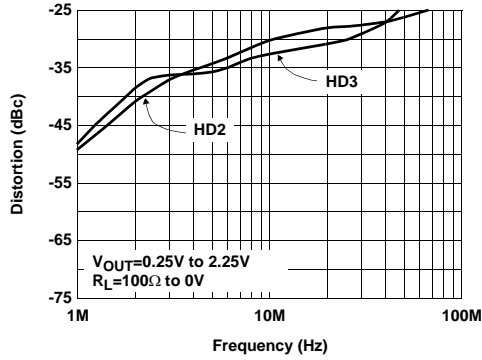

2nd and 3rd Harmonic Distortion vs Frequency

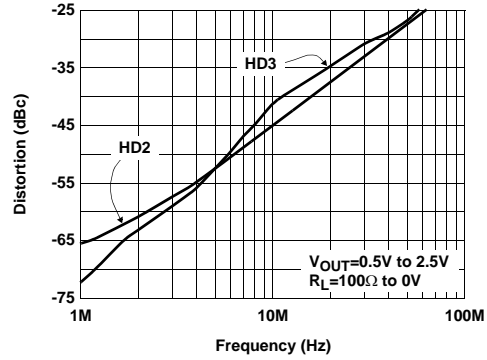

2nd and 3rd Harmonic Distortion vs. Frequency

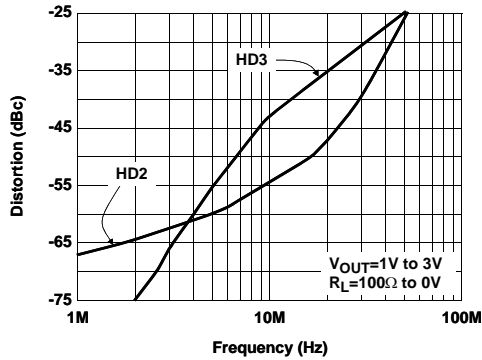

Channel to Channel Crosstalk - Duals and Quads (Worst Channel)

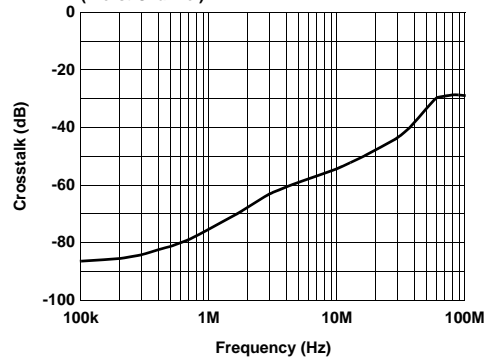

EL5144, EL5146, EL5244, EL5246, EL5444

Typical Performance Curves (Continued)

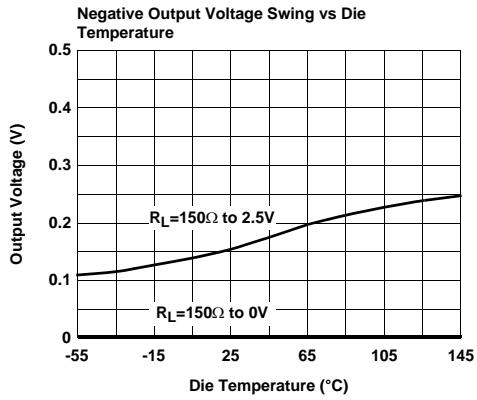
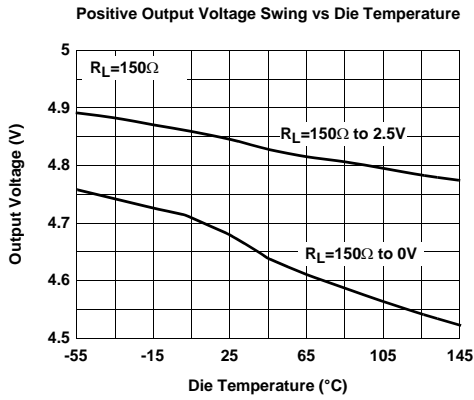
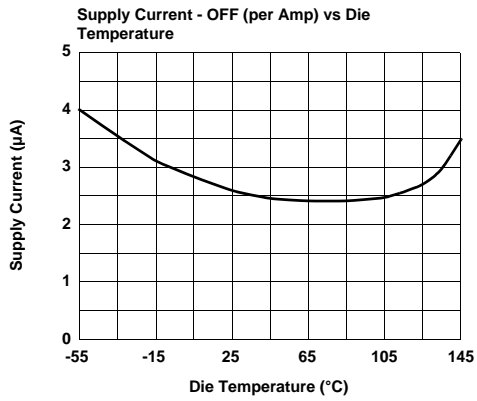
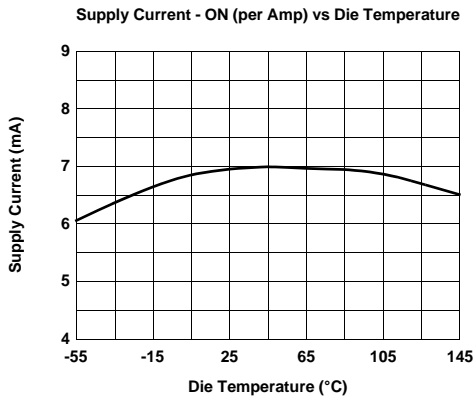
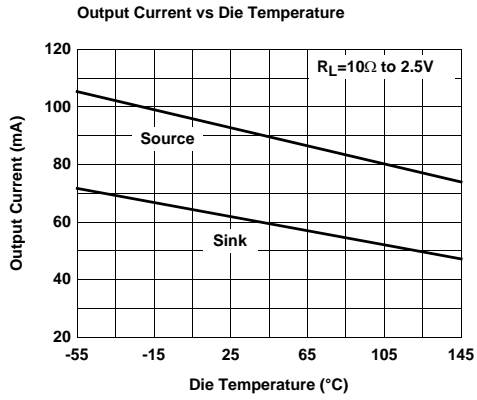
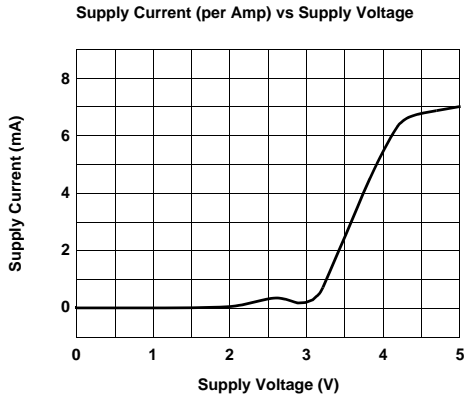

EL5144, EL5146, EL5244, EL5246, EL5444

Typical Performance Curves (Continued)

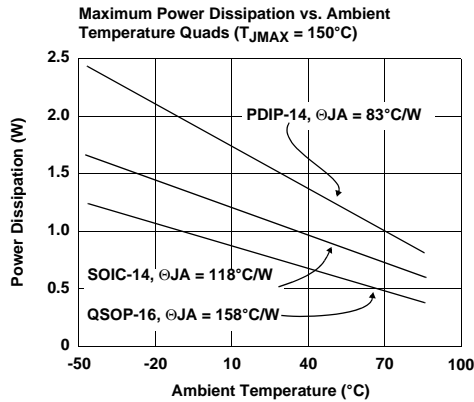
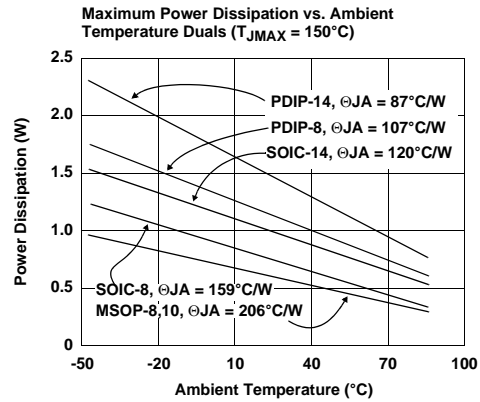
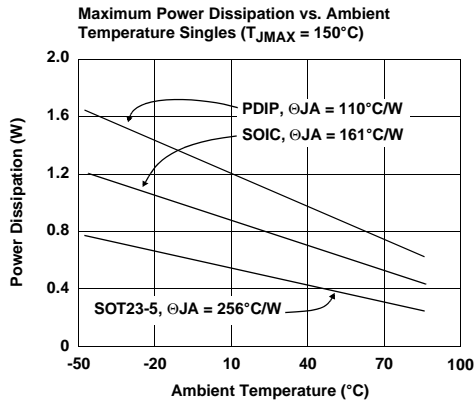
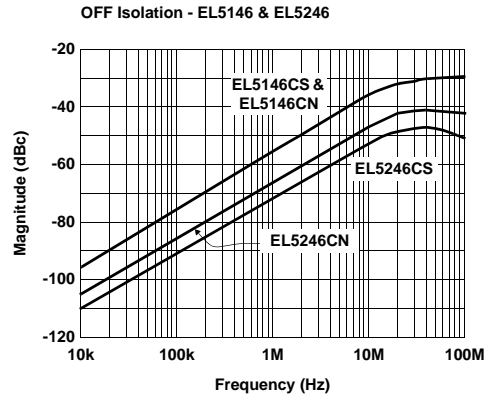
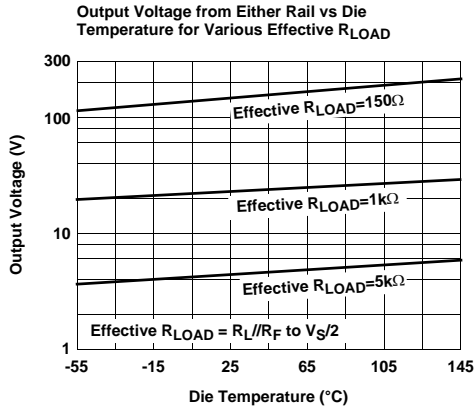

EL5144, EL5146, EL5244, EL5246, EL5444**Pin Descriptions**

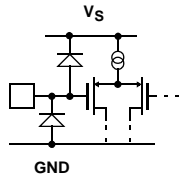
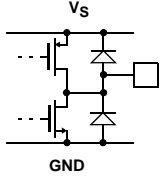
5-PIN SOT23	8-PIN SO/PDIP	8-PIN SO/PDIP/ MSOP	16-PIN MSOP	14-PIN SO/PDIP	14-PIN SO/PDIP	16-PIN QSOP	NAME	FUNCTION	EQUIVALENT CIRCUIT
5	7	8	8	11	4	4,5	VS	Positive Power Supply	
2	4	4	3	4	11	12,13	GND	Ground or Negative Power Supply	
3	3						IN+	Noninverting Input	 <p>Circuit 1</p>
4	2						IN-	Inverting Input	(Reference Circuit 1)
1	6						OUT	Amplifier Output	 <p>Circuit 2</p>
		3	1	1	3	3	INA+	Amplifier A Noninverting Input	(Reference Circuit 1)
		2	10	14	2	2	INA-	Amplifier A Inverting Input	(Reference Circuit 1)
		1	9	13	1	1	OUTA	Amplifier A Output	(Reference Circuit 2)
		5	5	7	5	6	INB+	Amplifier B Noninverting Input	(Reference Circuit 1)
		6	6	8	6	7	INB-	Amplifier B Inverting Input	(Reference Circuit 1)
		7	7	9	7	8	OUTB	Amplifier B Output	(Reference Circuit 2)
					10	11	INC+	Amplifier C Noninverting Input	(Reference Circuit 1)
					9	10	INC-	Amplifier C Inverting Input	(Reference Circuit 1)
					8	9	OUTC	Amplifier C Output	(Reference Circuit 2)
					12	14	IND+	Amplifier D Noninverting Input	(Reference Circuit 1)
					13	15	IND-	Amplifier D Inverting Input	(Reference Circuit 1)

EL5144, EL5146, EL5244, EL5246, EL5444**Pin Descriptions** (Continued)

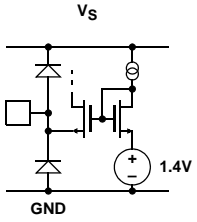
5-PIN SOT23	8-PIN SO/PDIP	8-PIN SO/PDIP/ MSOP	16-PIN MSOP	14-PIN SO/PDIP	14-PIN SO/PDIP	16-PIN QSOP	NAME	FUNCTION	EQUIVALENT CIRCUIT
					14	16	OUTD	Amplifier D Output	(Reference Circuit 2)
	8						CE	Enable (Enabled when high)	 <p>Circuit 3</p>
			2	3			CEA	Enable Amplifier A (Enabled when high)	(Reference Circuit 3)
			4	5			CEB	Enable Amplifier B (Enabled when high)	(Reference Circuit 3)
	1,5			2,6, 10,12			NC	No Connect. Not internally connected.	

Description of Operation and Applications Information**Product Description**

The EL5144 series is a family of wide bandwidth, single supply, low power, rail-to-rail output, voltage feedback operational amplifiers. The family includes single, dual, and quad configurations. The singles and duals are available with a power down pin to reduce power to 2.6 μ A typically. All the amplifiers are internally compensated for closed loop feedback gains of +1 or greater. Larger gains are acceptable but bandwidth will be reduced according to the familiar Gain-Bandwidth Product.

Connected in voltage follower mode and driving a high impedance load, the EL5144 series has a -3dB bandwidth of 100MHz. Driving a 150 Ω load, they have a -3dB bandwidth of 60MHz while maintaining a 200V/ μ s slew rate. The input common mode voltage range includes ground while the output can swing rail to rail.

Power Supply Bypassing and Printed Circuit Board Layout

As with any high-frequency device, good printed circuit board layout is necessary for optimum performance. Ground plane construction is highly recommended. Lead lengths should be as short as possible. The power supply pin must be well bypassed to reduce the risk of oscillation. For normal single supply operation, where the GND pin is connected to the ground plane, a single 4.7 μ F tantalum capacitor in parallel with a 0.1 μ F ceramic capacitor from V_S to GND will

suffice. This same capacitor combination should be placed at each supply pin to ground if split supplies are to be used. In this case, the GND pin becomes the negative supply rail.

For good AC performance, parasitic capacitance should be kept to a minimum. Use of wire wound resistors should be avoided because of their additional series inductance. Use of sockets, particularly for the SO package, should be avoided if possible. Sockets add parasitic inductance and capacitance that can result in compromised performance.

Input, Output, and Supply Voltage Range

The EL5144 series has been designed to operate with a single supply voltage of 5V. Split supplies can be used so long as their total range is 5V.

The amplifiers have an input common mode voltage range that includes the negative supply (GND pin) and extends to within 1.5V of the positive supply (V_S pin). They are specified over this range.

The output of the EL5144 series amplifiers can swing rail to rail. As the load resistance becomes lower in value, the ability to drive close to each rail is reduced. However, even with an effective 150 Ω load resistor connected to a voltage halfway between the supply rails, the output will swing to within 150mV of either rail.

EL5144, EL5146, EL5244, EL5246, EL5444

Figure 1 shows the output of the EL5144 series amplifier swinging rail to rail with $R_F = 1k\Omega$, $A_V = +2$ and $R_L = 1M\Omega$. Figure 2 is with $R_L = 150\Omega$.

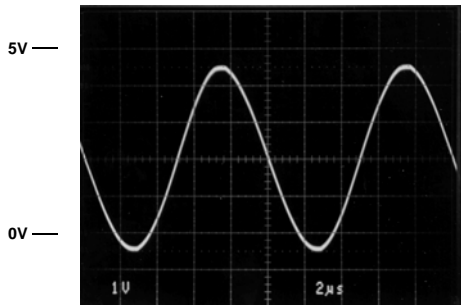
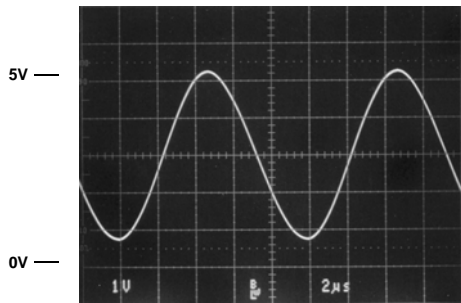
**FIGURE 1.****FIGURE 2.****Choice of Feedback Resistor, R_F**

These amplifiers are optimized for applications that require a gain of +1. Hence, no feedback resistor is required. However, for gains greater than +1, the feedback resistor forms a pole with the input capacitance. As this pole becomes larger, phase margin is reduced. This causes ringing in the time domain and peaking in the frequency domain. Therefore, R_F has some maximum value that should not be exceeded for optimum performance. If a large value of R_F must be used, a small capacitor in the few picofarad range in parallel with R_F can help to reduce this ringing and peaking at the expense of reducing the bandwidth.

As far as the output stage of the amplifier is concerned, $R_F + R_G$ appear in parallel with R_L for gains other than +1. As this combination gets smaller, the bandwidth falls off. Consequently, R_F also has a minimum value that should not be exceeded for optimum performance.

For $A_V = +1$, $R_F = 0\Omega$ is optimum. For $A_V = -1$ or +2 (noise gain of 2), optimum response is obtained with R_F between 300Ω and $1k\Omega$. For $A_V = -4$ or +5 (noise gain of 5), keep R_F between 300Ω and $15k\Omega$.

Video Performance

For good video signal integrity, an amplifier is required to maintain the same output impedance and the same frequency response as DC levels are changed at the output. This can be difficult when driving a standard video load of 150Ω , because of the change in output current with DC level. A look at the Differential Gain and Differential Phase curves for various supply and loading conditions will help you obtain optimal performance. Curves are provided for $A_V = +1$ and +2, and $R_L = 150\Omega$ and $10k\Omega$ tied both to ground as well as 2.5V. As with all video amplifiers, there is a common mode sweet spot for optimum differential gain/differential phase. For example, with $A_V = +2$ and $R_L = 150\Omega$ tied to 2.5V, and the output common mode voltage kept between 0.8V and 3.2V, dG/dP is a very low 0.1%/0.1°. This condition corresponds to driving an AC-coupled, double terminated 75Ω coaxial cable. With $A_V = +1$, $R_L = 150\Omega$ tied to ground, and the video level kept between 0.85V and 2.95V, these amplifiers provide dG/dP performance of 0.05%/0.20°. This condition is representative of using the EL5144 series amplifier as a buffer driving a DC coupled, double terminated, 75Ω coaxial cable. Driving high impedance loads, such as signals on computer video cards, gives similar or better dG/dP performance as driving cables.

Driving Cables and Capacitive Loads

The EL5144 series amplifiers can drive $50pF$ loads in parallel with 150Ω with 4dB of peaking and $100pF$ with 7dB of peaking. If less peaking is desired in these applications, a small series resistor (usually between 5Ω and 50Ω) can be placed in series with the output to eliminate most peaking. However, this will obviously reduce the gain slightly. If your gain is greater than 1, the gain resistor (R_G) can then be chosen to make up for any gain loss which may be created by this additional resistor at the output. Another method of reducing peaking is to add a "snubber" circuit at the output. A snubber is a resistor in a series with a capacitor, 150Ω and $100pF$ being typical values. The advantage of a snubber is that it does not draw DC load current.

When used as a cable driver, double termination is always recommended for reflection-free performance. For those applications, the back-termination series resistor will decouple the EL5144 series amplifier from the cable and allow extensive capacitive drive. However, other applications may have high capacitive loads without a back-termination resistor. Again, a small series resistor at the output can reduce peaking.

Disable/Power-Down

The EL5146 and EL5246 amplifiers can be disabled, placing its output in a high-impedance state. Turn off time is only 10ns and turn on time is around 500ns. When disabled, the amplifier's supply current is reduced to $2.6\mu A$ typically, thereby effectively eliminating power consumption. The amplifier's power down can be controlled by standard TTL or CMOS signal levels at the CE pin. The applied logic signal is

EL5144, EL5146, EL5244, EL5246, EL5444

relative to the GND pin. Letting the CE pin float will enable the amplifier. Hence, the 8-pin PDIP and SOIC single amps are pin compatible with standard amplifiers that don't have a power down feature.

Short Circuit Current Limit

The EL5144 series amplifiers do not have internal short circuit protection circuitry. Short circuit current of 90mA sourcing and 65mA sinking typically will flow if the output is trying to drive high or low but is shorted to half way between the rails. If an output is shorted indefinitely, the power dissipation could easily increase such that the part will be destroyed. Maximum reliability is maintained if the output current never exceeds $\pm 50\text{mA}$. This limit is set by internal metal interconnect limitations. Obviously, short circuit conditions must not remain or the internal metal connections will be destroyed.

Power Dissipation

With the high output drive capability of the EL5144 series amplifiers, it is possible to exceed the 150°C Absolute Maximum junction temperature under certain load current conditions. Therefore, it is important to calculate the maximum junction temperature for the application to determine if load conditions or package type need to be modified for the amplifier to remain in the safe operating area.

The maximum power dissipation allowed in a package is determined according to:

$$PD_{MAX} = \frac{T_{JMAX} - T_{AMAX}}{\theta_{JA}}$$

where:

T_{JMAX} = Maximum junction temperature

T_{AMAX} = Maximum ambient temperature

θ_{JA} = Thermal resistance of the package

PD_{MAX} = Maximum power dissipation in the package

The maximum power dissipation actually produced by an IC is the total quiescent supply current times the total power supply voltage, plus the power in the IC due to the load, or:

$$PD_{MAX} = N \times \left[V_S \times I_{SMAX} + (V_S - V_{OUT}) \times \frac{V_{OUT}}{R_L} \right]$$

where:

N = Number of amplifiers in the package

V_S = Total supply voltage

I_{SMAX} = Maximum supply current per amplifier

V_{OUT} = Maximum output voltage of the application

R_L = Load resistance tied to ground

If we set the two PD_{MAX} equations equal to each other, we can solve for R_L :

$$R_L = \frac{V_{OUT} \times (V_S - V_{OUT})}{\left(\frac{T_{JMAX} - T_{AMAX}}{N \times \theta_{JA}} \right) - (V_S \times I_{SMAX})}$$

Assuming worst case conditions of $T_A = +85^\circ\text{C}$, $V_{OUT} = V_S/2V$, $V_S = 5.5V$, and $I_{SMAX} = 8.8\text{mA}$ per amplifier, below is a table of all packages and the minimum R_L allowed.

PART	PACKAGE	MINIMUM R_L
EL5144CW	SOT23-5	37
EL5146CS	SOIC-8	21
EL5146CN	PDIP-8	14
EL5244CS	SOIC-8	48
EL5244CN	PDIP-8	30
EL5244CY	MSOP-8	69
EL5246CY	MSOP-10	69
EL5246CS	SOIC-14	34
EL5246CN	PDIP-14	23
EL5444CU	QSOP-16	139
EL5444CS	SOIC-14	85
EL5444CN	PDIP-14	51

EL5144 Series Comparator Application

The EL5144 series amplifier can be used as a very fast, single supply comparator. Most op amps used as a comparator allow only slow speed operation because of output saturation issues. The EL5144 series amplifier doesn't suffer from output saturation issues. Figure 3 shows the amplifier implemented as a comparator. Figure 4 is a

EL5144, EL5146, EL5244, EL5246, EL5444

graph of propagation delay vs. overdrive as a square wave is presented at the input of the comparator.

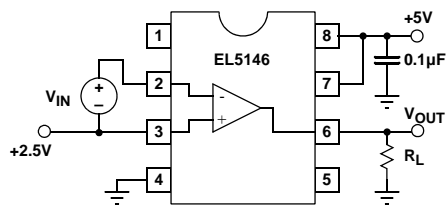

FIGURE 3.

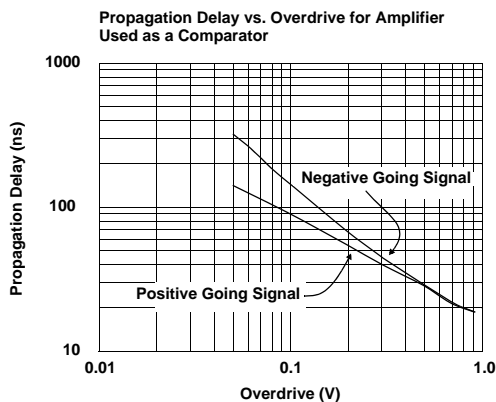

FIGURE 4.

Multiplexing with the EL5144 Series Amplifier

Besides normal power down usage, the CE pin on the EL5146 and EL5246 series amplifiers also allow for multiplexing applications. Figure 5 shows an EL5246 with its outputs tied together, driving a back terminated 75Ω video load. A 3V_{P-P} 10MHz sine wave is applied at Amp A input, and a 2.4V_{P-P} 5MHz square wave to Amp B. Figure 6 shows the SELECT signal that is applied, and the resulting output waveform at V_{OUT}. Observe the break-before-make operation of the multiplexing. Amp A is on and V_{IN1} is being passed through to the output of the amplifier. Then Amp A turns off in about 10ns. The output decays to ground with an R_LC_L time constants. 500ns later, Amp B turns on and V_{IN2} is passed through to the output. This break-before-make operation ensures that more than one amplifier isn't trying to drive the bus at the same time. Notice the outputs are tied

directly together. Isolation resistors at each output are not necessary.

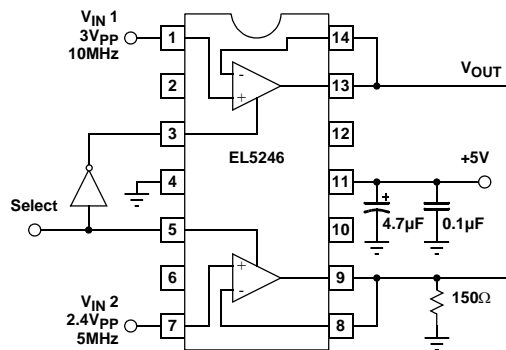

FIGURE 5.

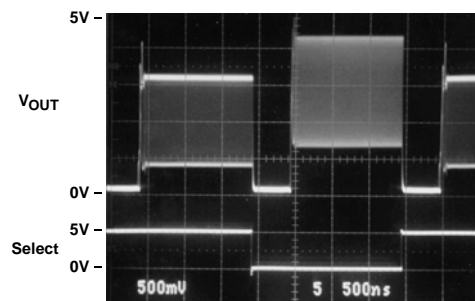

FIGURE 6.

Free Running Oscillator Application

Figure 7 is an EL5144 configured as a free running oscillator. To first order, R_{OSC} and C_{OSC} determine the frequency of oscillation according to:

$$F_{OSC} = \frac{0.72}{R_{OSC} \times C_{OSC}}$$

For rail to rail output swings, maximum frequency of oscillation is around 15MHz. If reduced output swings are acceptable, 25MHz can be achieved. Figure 8 shows the

EL5144, EL5146, EL5244, EL5246, EL5444

oscillator for $R_{OSC} = 510\Omega$, $C_{OSC} = 240\text{pF}$ and $F_{OSC} = 6\text{MHz}$.

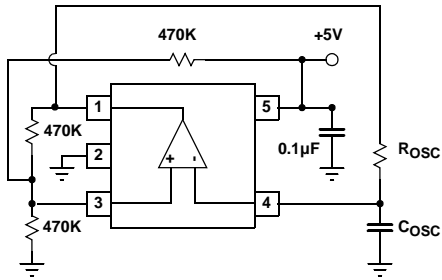

FIGURE 7.

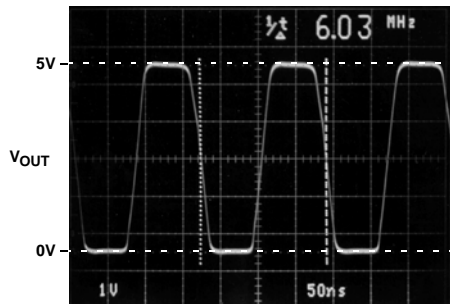

FIGURE 8.

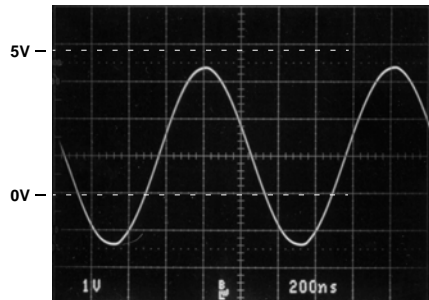

FIGURE 9.

All Intersil U.S. products are manufactured, assembled and tested utilizing ISO9000 quality systems.
Intersil Corporation's quality certifications can be viewed at www.intersil.com/design/quality

Intersil products are sold by description only. Intersil Corporation reserves the right to make changes in circuit design, software and/or specifications at any time without notice. Accordingly, the reader is cautioned to verify that data sheets are current before placing orders. Information furnished by Intersil is believed to be accurate and reliable. However, no responsibility is assumed by Intersil or its subsidiaries for its use; nor for any infringements of patents or other rights of third parties which may result from its use. No license is granted by implication or otherwise under any patent or patent rights of Intersil or its subsidiaries.

For information regarding Intersil Corporation and its products, see www.intersil.com

OUR CERTIFICATE

DiGi provide top-quality products and perfect service for customer worldwide through standardization, technological innovation and continuous improvement. DiGi through third-party certification, we stricly control the quality of products and services. Welcome your RFQ to

Email: Info@DiGi-Electronics.com



Tel: +00 852-30501935

RFQ Email: Info@DiGi-Electronics.com

DiGi is a global authorized distributor of electronic components.