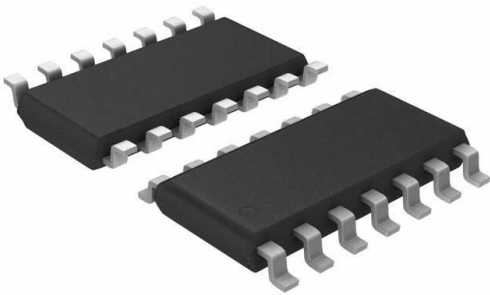


ISL55004IBZ Datasheet

www.digi-electronics.com



DiGi Electronics Part Number	ISL55004IBZ-DG
Manufacturer	Renesas Electronics Corporation
Manufacturer Product Number	ISL55004IBZ
Description	IC OPAMP VFB 4 CIRCUIT 14SOIC
Detailed Description	Voltage Feedback Amplifier 4 Circuit 14-SOIC

<https://www.DiGi-Electronics.com>



Tel: +00 852-30501935

RFQ Email: Info@DiGi-Electronics.com

DiGi is a global authorized distributor of electronic components.

Purchase and inquiry

Manufacturer Product Number:

ISL55004IBZ

Series:

-

Amplifier Type:

Voltage Feedback

Output Type:

-

Gain Bandwidth Product:

70 MHz

Current - Input Bias:

600 nA

Current - Supply:

8.5mA (x4 Channels)

Voltage - Supply Span (Min):

4.5 V

Operating Temperature:

-40°C ~ 85°C

Package / Case:

14-SOIC (0.154", 3.90mm Width)

Base Product Number:

ISL55004

Manufacturer:

Renesas Electronics Corporation

Product Status:

Obsolete

Number of Circuits:

4

Slew Rate:

300V/ μ s

-3db Bandwidth:

200 MHz

Voltage - Input Offset:

1.2 mV

Current - Output / Channel:

140 mA

Voltage - Supply Span (Max):

30 V

Mounting Type:

Surface Mount

Supplier Device Package:

14-SOIC

Environmental & Export classification

RoHS Status:

ROHS3 Compliant

REACH Status:

REACH Unaffected

HTSUS:

8542.33.0001

Moisture Sensitivity Level (MSL):

3 (168 Hours)

ECCN:

EAR99

ISL55004

High Supply Voltage 200MHz Unity-Gain Stable Operational Amplifier

 FN6219
 Rev 2.00
 July 27, 2006

The ISL55004 is a high speed, low power, low cost monolithic operational amplifier. The ISL55004 is unity-gain stable and features a 300V/ μ s slew rate and 200MHz bandwidth while requiring only 8.5mA of supply current per amplifier.

The power supply operating range of the ISL55004 is from ± 15 V down to ± 2.5 V. For single-supply operation, the ISL55004 operates from 30V down to 5V.

The ISL55004 also features an extremely wide output voltage swing of -12.75V/+13.4V with $V_S = \pm 15$ V and $R_L = 1k\Omega$.

At a gain of +1, the ISL55004 has a -3dB bandwidth of 200MHz with a phase margin of 55°. Because of its conventional voltage-feedback topology, the ISL55004 allow the use of reactive or non-linear elements in its feedback network. This versatility combined with low cost and 140mA of output-current drive makes the ISL55004 an ideal choice for price-sensitive applications requiring low power and high speed.

The ISL55004 is in a 14 Ld SO (0.150") package and specified for operation over the full -40°C to +85°C temperature range.

Ordering Information

PART NUMBER	PART MARKING	TAPE & REEL	PACKAGE	PKG. DWG. #
ISL55004IB	55004IB	-	14 Ld SO (0.150")	MDP0027
ISL55004IB-T7	55004IB	7"	14 Ld SO (0.150")	MDP0027
ISL55004IB-T13	55004IB	13"	14 Ld SO (0.150")	MDP0027
ISL55004IBZ (See Note)	55004IBZ	-	14 Ld SO (0.150") (Pb-Free)	MDP0027
ISL55004IBZ-T7 (See Note)	55004IBZ	7"	14 Ld SO (0.150") (Pb-Free)	MDP0027
ISL55004IBZ-T13 (See Note)	55004IBZ	13"	14 Ld SO (0.150") (Pb-Free)	MDP0027

NOTE: Intersil Pb-free plus anneal products employ special Pb-free material sets; molding compounds/die attach materials and 100% matte tin plate termination finish, which are RoHS compliant and compatible with both SnPb and Pb-free soldering operations. Intersil Pb-free products are MSL classified at Pb-free peak reflow temperatures that meet or exceed the Pb-free requirements of IPC/JEDEC J STD-020.

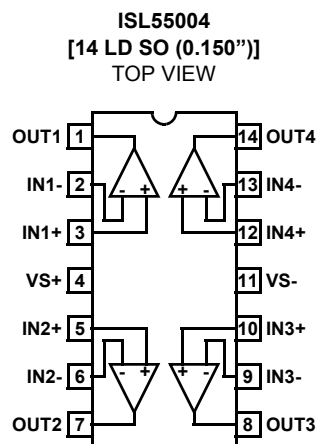
Features

- 200MHz -3dB bandwidth
- Unity-gain stable
- Low supply current: 8.5mA per amplifier
- Wide supply range: ± 2.5 V to ± 15 V dual-supply and 5V to 30V single-supply
- High slew rate: 300V/ μ s
- Fast settling: 75ns to 0.1% for a 10V step
- Wide output voltage swing: -12.75V/+13.4V with $V_S = \pm 15$ V, $R_L = 1k\Omega$
- Enhanced replacement for EL2444
- Pb-free plus anneal available (RoHS compliant)

Applications

- Video amplifiers
- Single-supply amplifiers
- Active filters/integrators
- High speed sample-and-hold
- High speed signal processing
- ADC/DAC buffers
- Pulse/RF amplifiers
- Pin diode receivers
- Log amplifiers
- Photo multiplier amplifiers
- Difference amplifiers

Pinout



ISL55004

Absolute Maximum Ratings ($T_A = 25^\circ\text{C}$)

Supply Voltage (V_S) $\pm 16.5\text{V}$ or 33V
 Input Voltage (V_{IN}) $\pm V_S$
 Differential Input Voltage (dV_{IN}) $\pm 10\text{V}$
 Continuous Output Current 60mA

Power Dissipation (P_D) See Curves
 Operating Temperature Range (T_A) -40°C to $+85^\circ\text{C}$
 Operating Junction Temperature (T_J) $+150^\circ\text{C}$
 Storage Temperature (T_{ST}) -65°C to $+150^\circ\text{C}$

CAUTION: Stresses above those listed in "Absolute Maximum Ratings" may cause permanent damage to the device. This is a stress only rating and operation of the device at these or any other conditions above those indicated in the operational sections of this specification is not implied.

IMPORTANT NOTE: All parameters having Min/Max specifications are guaranteed. Typical values are for information purposes only. Unless otherwise noted, all tests are at the specified temperature and are pulsed tests, therefore: $T_J = T_C = T_A$

DC Electrical Specifications $V_S = \pm 15\text{V}$, $A_V = +1$, $R_L = 1\text{k}\Omega$, $T_A = 25^\circ\text{C}$, unless otherwise specified.

PARAMETER	DESCRIPTION	CONDITION	MIN	TYP	MAX	UNIT
V_{OS}	Input Offset Voltage	$V_S = \pm 15\text{V}$		1.2	5	mV
TCV_{OS}	Average Offset Voltage Drift (Note 1)			17		$\mu\text{V}/^\circ\text{C}$
I_B	Input Bias Current	$V_S = \pm 15\text{V}$		0.6	3.5	μA
I_{OS}	Input Offset Current	$V_S = \pm 15\text{V}$		0.2	2	μA
TCI_{OS}	Average Offset Current Drift (Note 1)			0.2		$\text{nA}/^\circ\text{C}$
A_{VOL}	Open-loop Gain	$V_S = \pm 15\text{V}$, $V_{OUT} = \pm 10\text{V}$, $R_L = 1\text{k}\Omega$	12000	21000		V/V
PSRR	Power Supply Rejection Ratio	$V_S = \pm 5\text{V}$ to $\pm 15\text{V}$	75	100		dB
CMRR	Common-mode Rejection Ratio	$V_{CM} = \pm 10\text{V}$, $V_{OUT} = 0\text{V}$	75	90		dB
CMIR	Common-mode Input Range	$V_S = \pm 15\text{V}$		13		V
V_{OUT}	Output Voltage Swing	V_{O+} , $R_L = 1\text{k}\Omega$	13.25	13.4		V
		V_{O-} , $R_L = 1\text{k}\Omega$	-12.6	-12.75		V
		V_{O+} , $R_L = 150\Omega$	9.6	10.7		V
		V_{O-} , $R_L = 150\Omega$	-8.3	-9.4		V
I_{SC}	Output Short Circuit Current		80	140		mA
I_S	Supply Current (per amplifier)	$V_S = \pm 15\text{V}$, no load		8.5	9.25	mA
R_{IN}	Input Resistance		2.0	3.2		$\text{M}\Omega$
C_{IN}	Input Capacitance	$A_V = +1$		1		pF
R_{OUT}	Output Resistance	$A_V = +1$		50		$\text{m}\Omega$
PSOR	Power Supply Operating Range	Dual supply	± 2.25		± 15	V
		Single supply	4.5		30	V

NOTE:

1. Measured from T_{MIN} to T_{MAX} .

AC Electrical Specifications $V_S = \pm 15\text{V}$, $A_V = +1$, $R_L = 1\text{k}\Omega$, $T_A = 25^\circ\text{C}$, unless otherwise specified.

PARAMETER	DESCRIPTION	CONDITION	MIN	TYP	MAX	UNIT
BW	-3dB Bandwidth ($V_{OUT} = 0.4V_{PP}$)	$V_S = \pm 15\text{V}$, $A_V = +1$		200		MHz
		$V_S = \pm 15\text{V}$, $A_V = -1$		55		MHz
		$V_S = \pm 15\text{V}$, $A_V = +2$		53		MHz
		$V_S = \pm 15\text{V}$, $A_V = +5$		17		MHz
GBWP	Gain Bandwidth Product	$V_S = \pm 15\text{V}$		70		MHz
PM	Phase Margin	$R_L = 1\text{k}\Omega$, $C_L = 5\text{pF}$		55		$^\circ$
SR	Slew Rate (Note 1)		260	300		$\text{V}/\mu\text{s}$

ISL55004

AC Electrical Specifications $V_S = \pm 15V$, $A_V = +1$, $R_L = 1k\Omega$, $T_A = 25^\circ C$, unless otherwise specified. (Continued)

PARAMETER	DESCRIPTION	CONDITION	MIN	TYP	MAX	UNIT
FPBW	Full-power Bandwidth (Note 2)	$V_S = \pm 15V$		9.5		MHz
t_S	Settling to +0.1% ($A_V = +1$)	$V_S = \pm 15V$, 10V step		75		ns
dG	Differential Gain (Note 3)	NTSC/PAL		0.01		%
dP	Differential Phase	NTSC/PAL		0.05		°
eN	Input Noise Voltage	10kHz		12		nV/ \sqrt{Hz}
iN	Input Noise Current	10kHz		1.5		pA/ \sqrt{Hz}

NOTES:

- Slew rate is measured on rising edge.
- For $V_S = \pm 15V$, $V_{OUT} = 10V_{PP}$, for $V_S = \pm 5V$, $V_{OUT} = 5V_{PP}$. Full-power bandwidth is based on slew rate measurement using $FPBW = SR/(2\pi * V_{PEAK})$.
- Video performance measured at $V_S = \pm 15V$, $A_V = +2$ with two times normal video level across $R_L = 150\Omega$. This corresponds to standard video levels across a back-terminated 75Ω load. For other values or R_L , see curves.

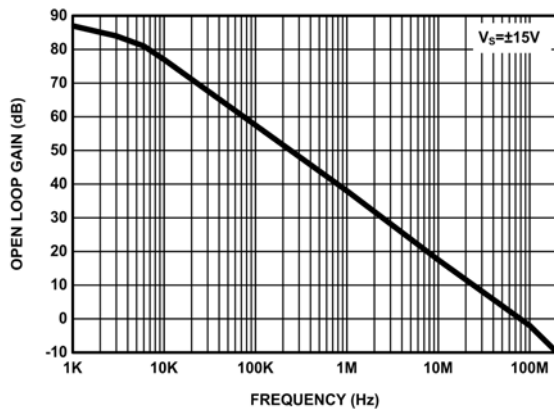
Typical Performance Curves

FIGURE 1. OPEN-LOOP GAIN vs FREQUENCY

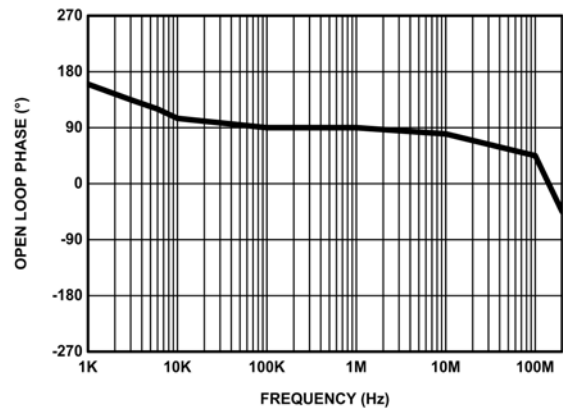


FIGURE 2. OPEN-LOOP PHASE vs FREQUENCY

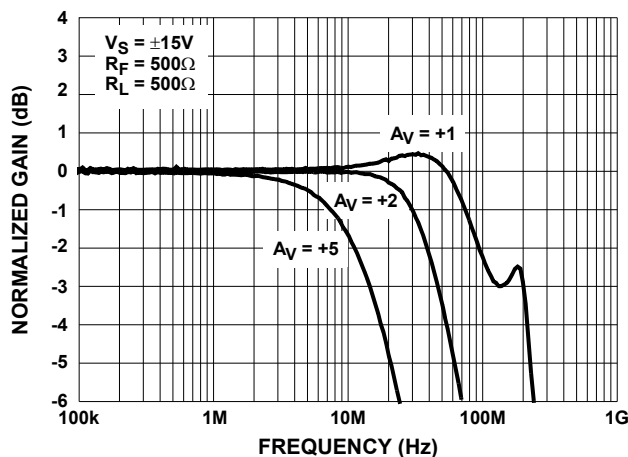


FIGURE 3. GAIN vs FREQUENCY FOR VARIOUS NON-INVERTING GAIN SETTINGS

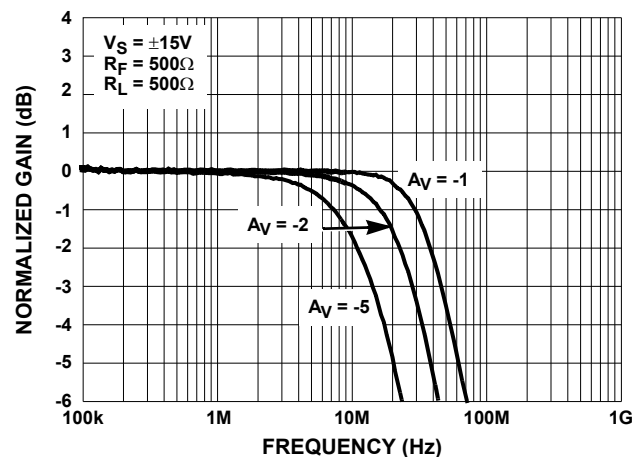


FIGURE 4. GAIN vs FREQUENCY FOR VARIOUS INVERTING GAIN SETTINGS

ISL55004

Typical Performance Curves (Continued)

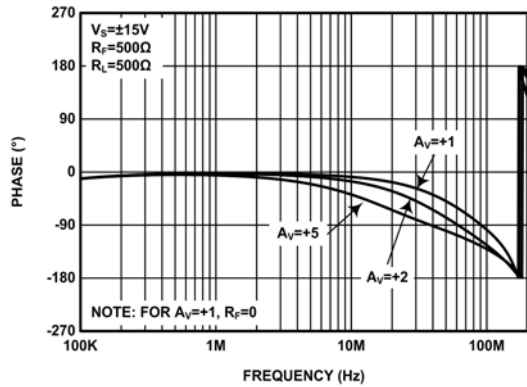


FIGURE 5. PHASE vs FREQUENCY FOR VARIOUS NON-INVERTING GAIN SETTINGS

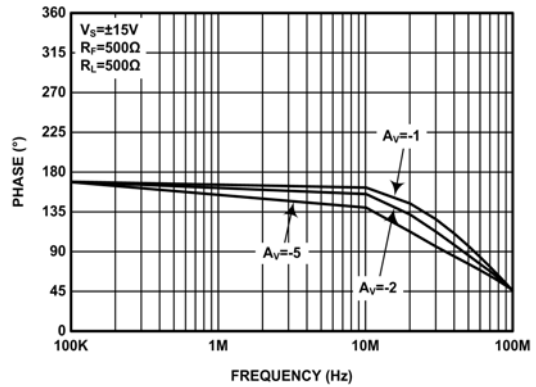


FIGURE 6. PHASE vs FREQUENCY FOR VARIOUS INVERTING GAIN SETTINGS

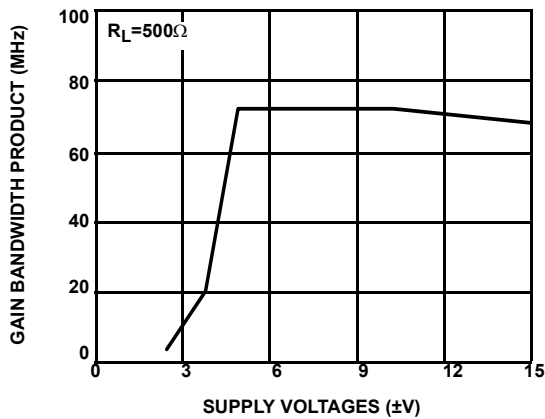


FIGURE 7. GAIN BANDWIDTH PRODUCT vs SUPPLY

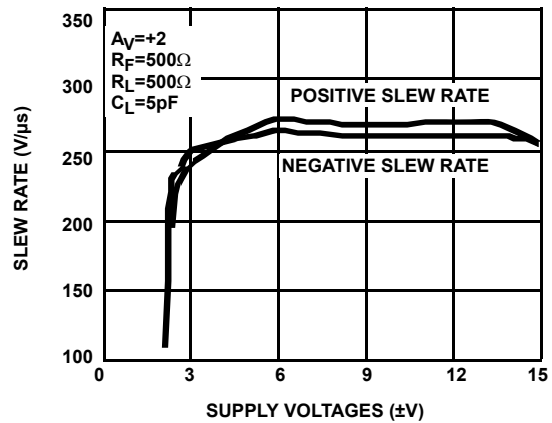


FIGURE 8. SLEW RATE vs SUPPLY

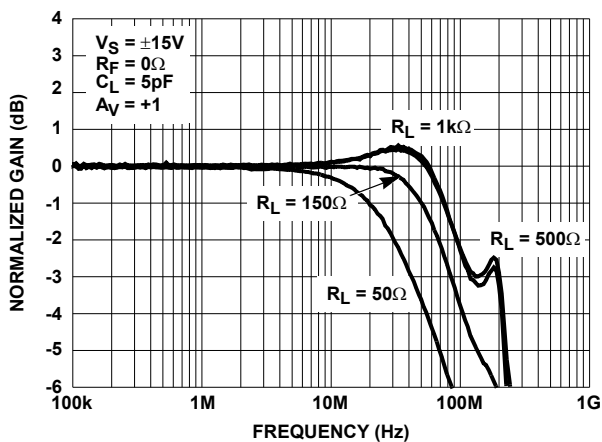


FIGURE 9. GAIN vs FREQUENCY FOR VARIOUS R_{LOAD} ($A_V = +1$)

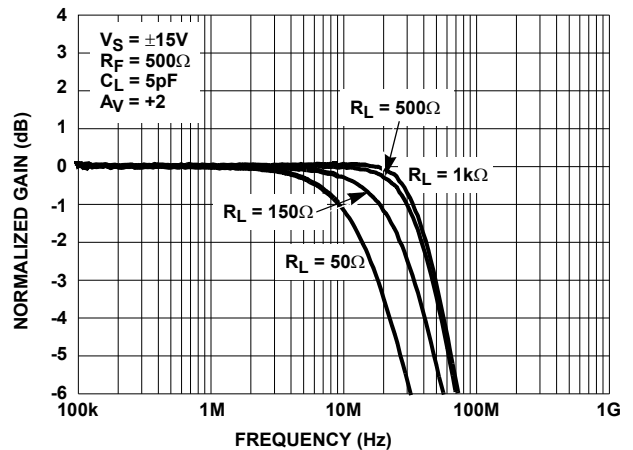


FIGURE 10. GAIN vs FREQUENCY FOR VARIOUS R_{LOAD} ($A_V = +2$)

ISL55004

Typical Performance Curves (Continued)

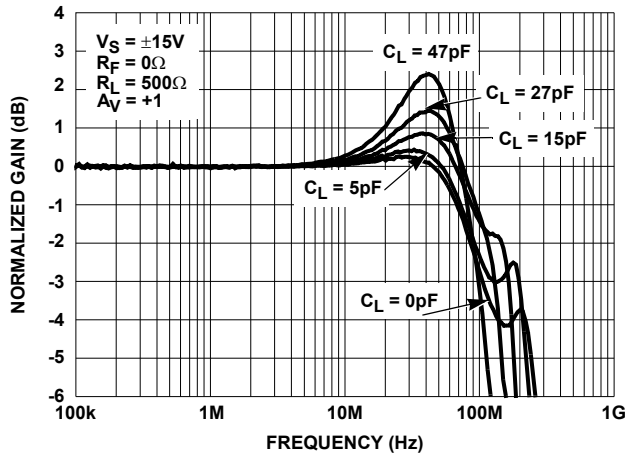


FIGURE 11. GAIN vs FREQUENCY FOR VARIOUS C_{LOAD} ($A_V = +1$)

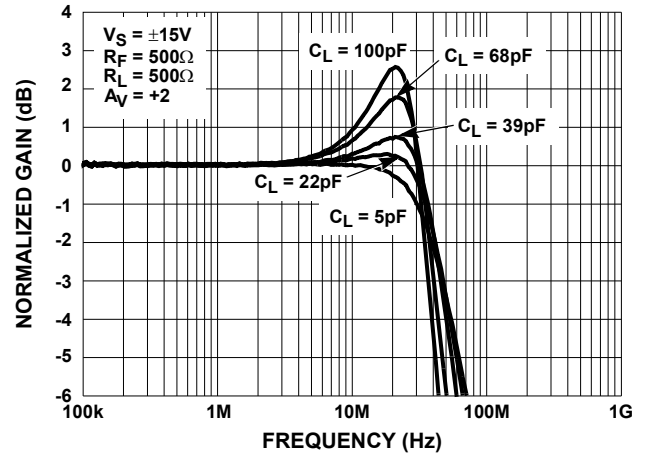


FIGURE 12. GAIN vs FREQUENCY FOR VARIOUS C_{LOAD} ($A_V = +2$)

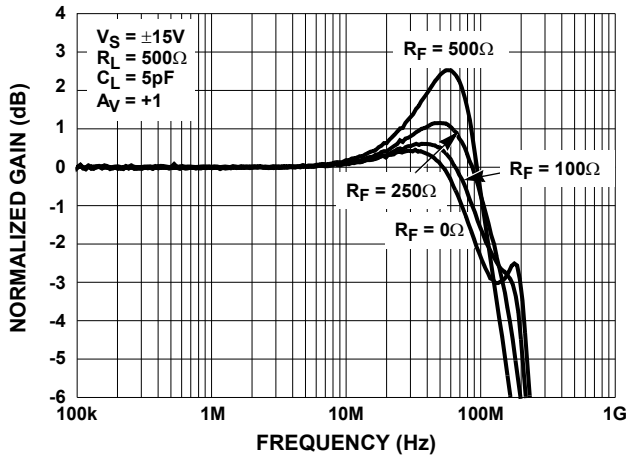


FIGURE 13. GAIN vs FREQUENCY FOR VARIOUS $R_{FEEDBACK}$ ($A_V = +1$)

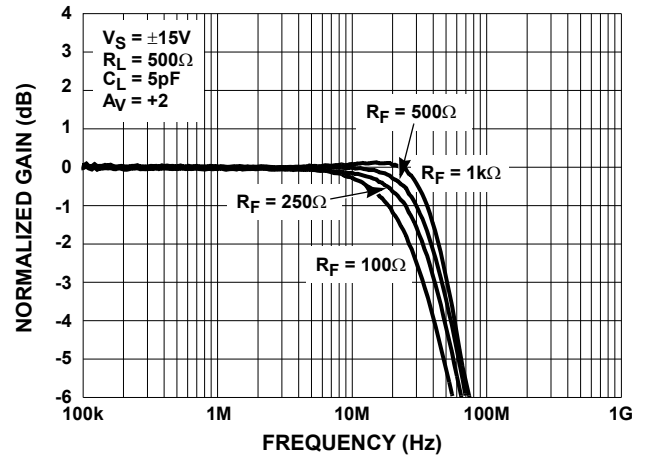


FIGURE 14. GAIN vs FREQUENCY FOR VARIOUS $R_{FEEDBACK}$ ($A_V = +2$)

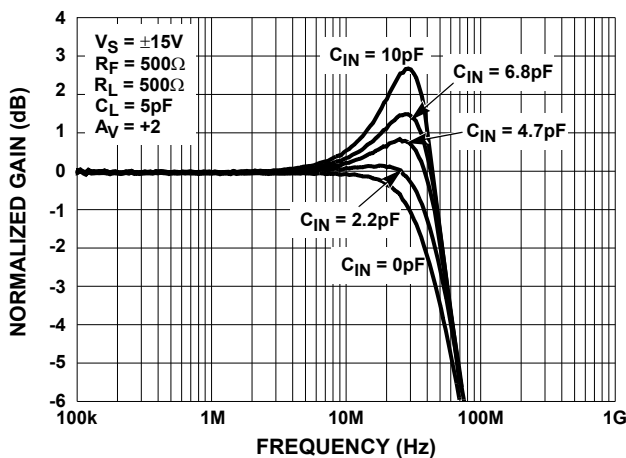


FIGURE 15. GAIN vs FREQUENCY FOR VARIOUS INVERTING INPUT CAPACITANCE (C_{IN})

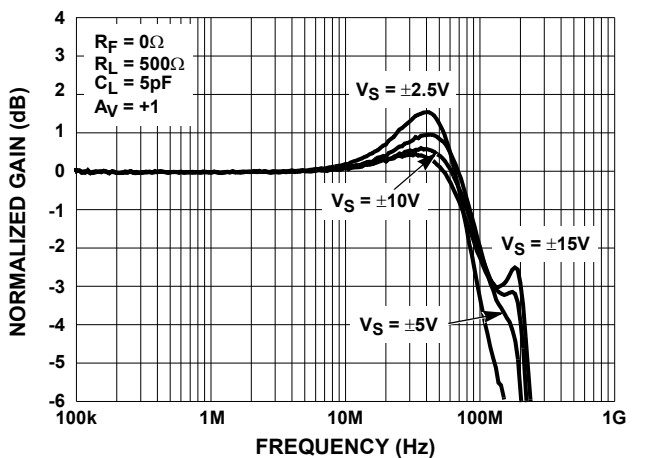


FIGURE 16. GAIN vs FREQUENCY FOR VARIOUS SUPPLY SETTINGS

ISL55004

Typical Performance Curves (Continued)

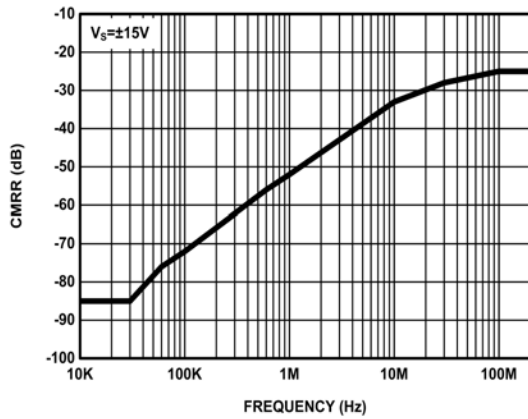


FIGURE 17. COMMON-MODE REJECTION RATIO (CMRR)

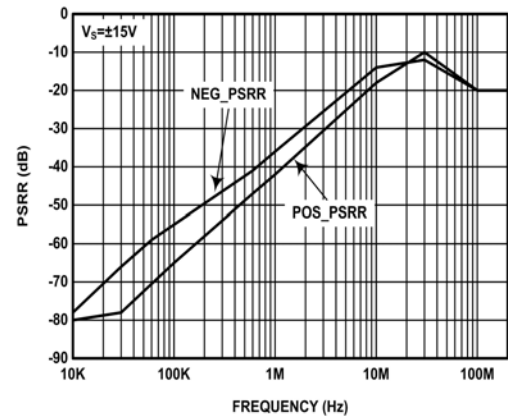


FIGURE 18. POWER SUPPLY REJECTION RATIO (PSRR)

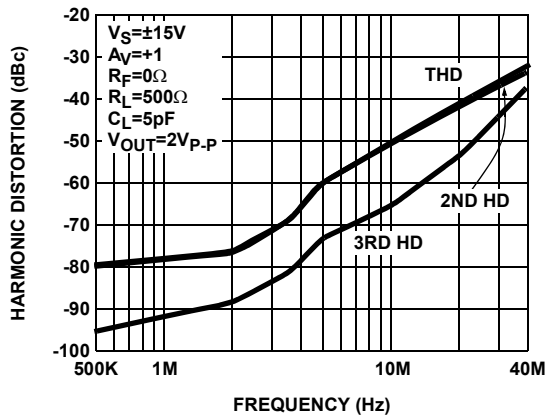


FIGURE 19. HARMONIC DISTORTION vs FREQUENCY ($A_V = +1$)

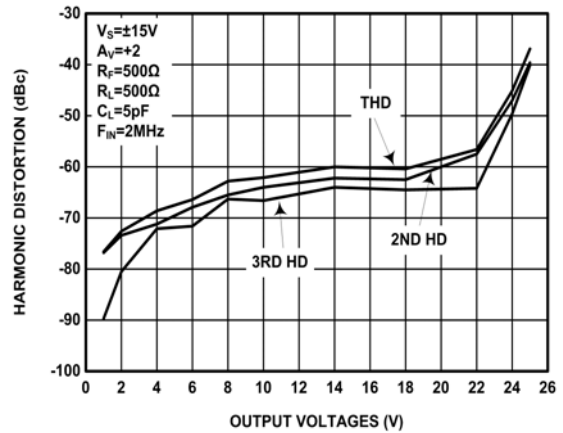


FIGURE 20. HARMONIC DISTORTION vs OUTPUT VOLTAGE ($A_V = +2$)

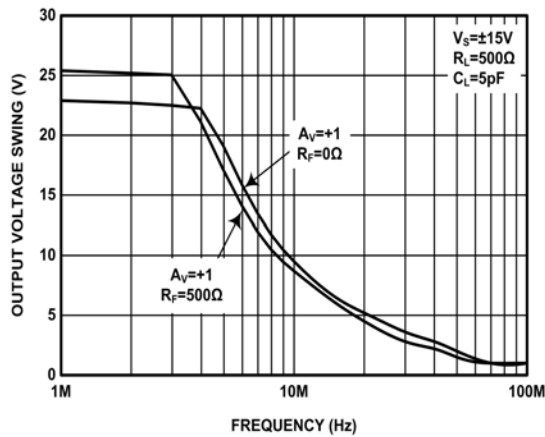


FIGURE 21. OUTPUT SWING vs FREQUENCY FOR VARIOUS GAIN SETTINGS

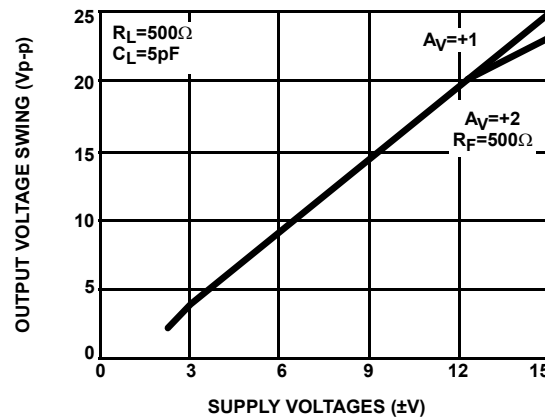


FIGURE 22. OUTPUT SWING vs SUPPLY VOLTAGE FOR VARIOUS GAIN SETTINGS

ISL55004

Typical Performance Curves (Continued)

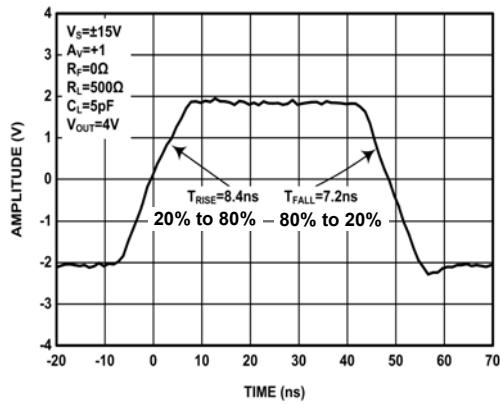


FIGURE 23. LARGE SIGNAL RISE AND FALL TIMES

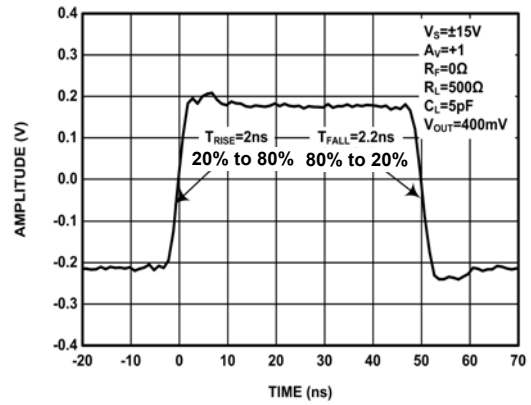


FIGURE 24. SMALL SIGNAL RISE AND FALL TIMES

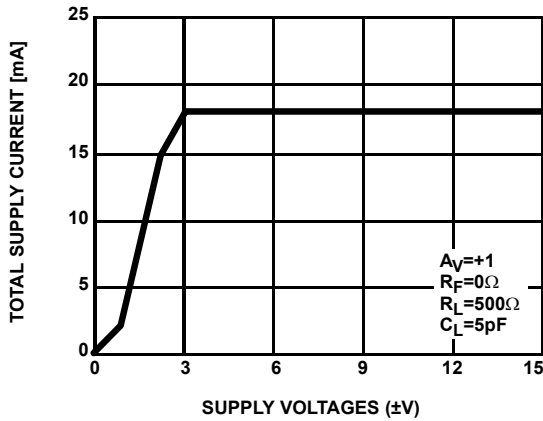


FIGURE 25. SUPPLY CURRENT vs SUPPLY VOLTAGE

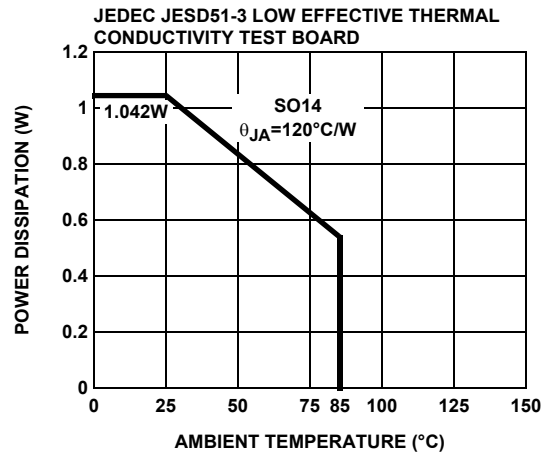


FIGURE 26. PACKAGE POWER DISSIPATION vs AMBIENT TEMPERATURE

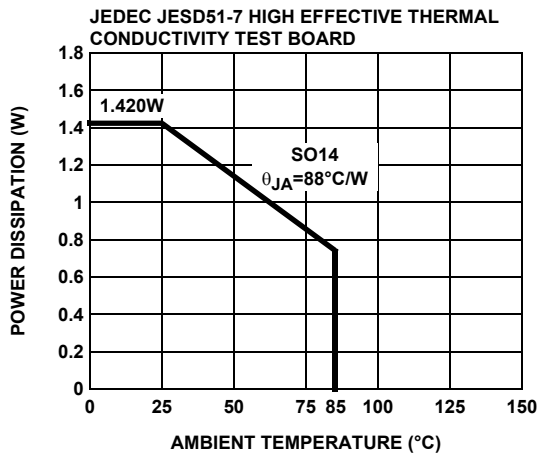


FIGURE 27. PACKAGE POWER DISSIPATION vs AMBIENT TEMPERATURE

ISL55004

Product Description

The ISL55004 is a wide bandwidth, low power, and low offset voltage feedback operational amplifier. This device is internally compensated for closed loop gain of +1 or greater. Connected in voltage follower mode and driving a 500Ω load, the -3dB bandwidth is around a 200MHz. Driving a 150Ω load and a gain of 2, the bandwidth is about 90MHz while maintaining a 300V/μs slew rate.

The ISL55004 is designed to operate with supply voltage from +15V to -15V. That means for single supply application, the supply voltage is from 0V to 30V. For split supplies application, the supply voltage is from ±15V. The amplifier has an input common-mode voltage range from 1.5V above the negative supply (V_{S-} pin) to 1.5V below the positive supply (V_{S+} pin). If the input signal is outside the above specified range, it will cause the output signal to be distorted.

The outputs of the ISL55004 can swing from -12.75V to +13.4V for $V_S = \pm 15V$. As the load resistance becomes lower, the output swing is lower.

Choice of Feedback Resistor and Gain Bandwidth Product

For applications that require a gain of +1, no feedback resistor is required. Just short the output pin to the inverting input pin. For gains greater than +1, the feedback resistor forms a pole with the parasitic capacitance at the inverting input. As this pole becomes smaller, the amplifier's phase margin is reduced. This causes ringing in the time domain and peaking in the frequency domain. Therefore, R_F can't be very big for optimum performance. If a large value of R_F must be used, a small capacitor in the few Pico Farad range in parallel with R_F can help to reduce the ringing and peaking at the expense of reducing the bandwidth. For gain of +1, $R_F = 0$ is optimum. For the gains other than +1, optimum response is obtained with R_F with proper selection of R_F and R_G (see Figures 15 and 16 for selection).

Video Performance

For good video performance, an amplifier is required to maintain the same output impedance and the same frequency response as DC levels are changed at the output. This is especially difficult when driving a standard video load of 150Ω, because of the change in output current with DC level. The dG and dP of this device is about 0.01% and 0.05°, while driving 150Ω at a gain of 2. Driving high impedance loads would give a similar or better dG and dP performance.

Driving Capacitive Loads and Cables

The ISL55004 can drive 47pF loads in parallel with 500Ω with less than 3dB of peaking at gain of +1 and as much as 100pF at a gain of +2 with under 3dB of peaking. If less peaking is desired in applications, a small series resistor (usually between 5Ω to 50Ω) can be placed in series with the output to eliminate most peaking. However, this will reduce the gain slightly. If the gain setting is greater than 1, the gain resistor R_G can then be

chosen to make up for any gain loss which may be created by the additional series resistor at the output.

When used as a cable driver, double termination is always recommended for reflection-free performance. For those applications, a back-termination series resistor at the amplifier's output will isolate the amplifier from the cable and allow extensive capacitive drive. However, other applications may have high capacitive loads without a back-termination resistor. Again, a small series resistor at the output can help to reduce peaking.

Output Drive Capability

The ISL55004 does not have internal short circuit protection circuitry. It has a typical short circuit current of 140mA. If the output is shorted indefinitely, the power dissipation could easily overheat the die or the current could eventually compromise metal integrity. Maximum reliability is maintained if the output current never exceeds ±60mA. This limit is set by the design of the internal metal interconnect. Note that in transient applications, the part is robust.

Short circuit protection can be provided externally with a back match resistor in series with the output placed close as possible to the output pin. In video applications this would be a 75Ω resistor and will provide adequate short circuit protection to the device. Care should still be taken not to stress the device with a short at the output.

Power Dissipation

With the high output drive capability of the ISL55004, it is possible to exceed the 150°C absolute maximum junction temperature under certain load current conditions. Therefore, it is important to calculate the maximum junction temperature for an application to determine if load conditions or package types need to be modified to assure operation of the amplifier in a safe operating area.

The maximum power dissipation allowed in a package is determined according to:

$$PD_{MAX} = \frac{T_{JMAX} - T_{AMAX}}{\theta_{JA}}$$

Where:

- T_{JMAX} = Maximum junction temperature
- T_{AMAX} = Maximum ambient temperature
- θ_{JA} = Thermal resistance of the package

The maximum power dissipation actually produced by an IC is the total quiescent supply current times the total power supply voltage, plus the power in the IC due to the load, or:

For sourcing:

$$PD_{MAX} = V_S \times I_{SMAX} + \sum_{i=1}^n (V_S - V_{OUTi}) \times \frac{V_{OUTi}}{R_{Li}}$$

ISL55004

For sinking:

$$PD_{MAX} = V_S \times I_{SMAX} + \sum_{i=1}^n (V_{OUTi} - V_S) \times I_{LOADi}$$

Where:

- V_S = Supply voltage
- I_{SMAX} = Maximum quiescent supply current
- V_{OUT} = Maximum output voltage of the application
- R_{LOAD} = Load resistance tied to ground
- I_{LOAD} = Load current
- N = number of amplifiers (max = 4)

By setting the two PD_{MAX} equations equal to each other, we can solve the output current and R_{LOAD} to avoid the device overheat.

Caution: For supply voltages greater than 20V, the maximum power dissipation at 85°C ambient temperature could be exceeded. For higher supply voltages the maximum ambient temperature must be de-rated according to the Package Power Dissipation curve Figure 27. The maximum power dissipation is highly dependent upon the thermal conductivity of the PCB. For lower thermal conductivity boards use Figure 26.

Power Supply Bypassing Printed Circuit Board Layout

As with any high frequency device, a good printed circuit board layout is necessary for optimum performance. Lead lengths should be as short as possible. The power supply pin must be well bypassed to reduce the risk of oscillation. For normal single supply operation, where the V_S - pin is connected to the ground plane, a single 4.7µF tantalum capacitor in parallel with a 0.1µF ceramic capacitor from V_S+ to GND will suffice. This same capacitor combination should be placed at each supply pin to ground if split supplies are to be used. In this case, the V_S - pin becomes the negative supply rail.

Printed Circuit Board Layout

For good AC performance, parasitic capacitance should be kept to minimum. Use of wire wound resistors should be avoided because of their additional series inductance. Use of sockets should also be avoided if possible. Sockets add parasitic inductance and capacitance that can result in compromised performance. Minimizing parasitic capacitance at the amplifier's inverting input pin is very important. The feedback resistor should be placed very close to the inverting input pin. Strip line design techniques are recommended for the signal traces.

Application Circuits

Sallen Key Low Pass Filter

A common and easy to implement filter taking advantage of the wide bandwidth, low offset and low power demands of the ISL55004. A derivation of the transfer function is provided for convenience (See Figure 28).

Sallen Key High Pass Filter

Again this useful filter benefits from the characteristics of the ISL55004. The transfer function is very similar to the low pass so only the results are presented (See Figure 29).

© Copyright Intersil Americas LLC 2005-2006. All Rights Reserved.

All trademarks and registered trademarks are the property of their respective owners.

For additional products, see www.intersil.com/en/products.html

Intersil products are manufactured, assembled and tested utilizing ISO9001 quality systems as noted in the quality certifications found at www.intersil.com/en/support/qualandreliability.html

Intersil products are sold by description only. Intersil may modify the circuit design and/or specifications of products at any time without notice, provided that such modification does not, in Intersil's sole judgment, affect the form, fit or function of the product. Accordingly, the reader is cautioned to verify that datasheets are current before placing orders. Information furnished by Intersil is believed to be accurate and reliable. However, no responsibility is assumed by Intersil or its subsidiaries for its use; nor for any infringements of patents or other rights of third parties which may result from its use. No license is granted by implication or otherwise under any patent or patent rights of Intersil or its subsidiaries.

For information regarding Intersil Corporation and its products, see www.intersil.com

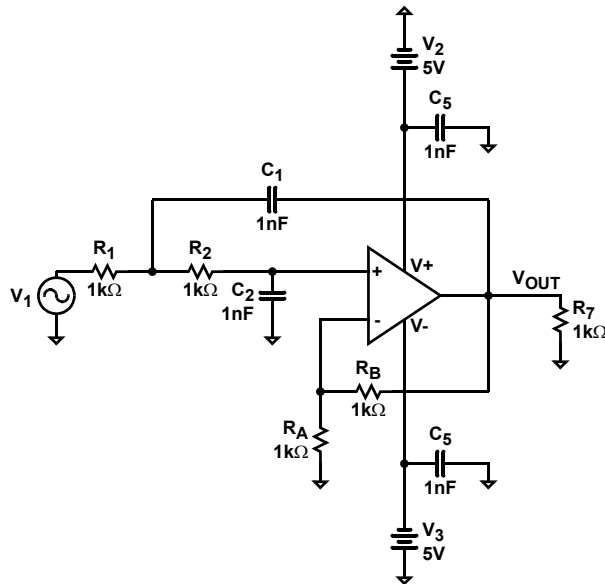


FIGURE 28. SALLEN KEY LOW PASS FILTER

$$K = 1 + \frac{R_B}{R_A}$$

$$V_o = K \frac{1}{R_2 C_2 s + 1} V_1$$

$$\frac{V_1 - V_i}{R_1} + \frac{K - V_1}{R_2} + \frac{V_o - V_i}{C_1 s} = 0$$

$$H(s) = \frac{K}{R_1 C_1 R_2 C_2 s^2 + ((1 - K)R_1 C_1 + R_1 C_2 + R_2 C_2)s + 1}$$

$$H(j\omega) = \frac{1}{1 - \omega^2 R_1 C_1 R_2 C_2 + j\omega((1 - K)R_1 C_1 + R_1 C_2 + R_2 C_2)}$$

$$H_{olp} = K$$

$$\omega_o = \frac{1}{\sqrt{R_1 C_1 R_2 C_2}}$$

$$Q = \frac{1}{(1 - K)\sqrt{\frac{R_1 C_1}{R_2 C_2}} + \sqrt{\frac{R_1 C_2}{R_2 C_1}} + \sqrt{\frac{R_2 C_2}{R_1 C_1}}}$$

Equations simplify if we let all components be equal R=C

$$H_{olp} = K$$

$$\omega_o = \frac{1}{RC}$$

$$Q = \frac{1}{3 - K}$$

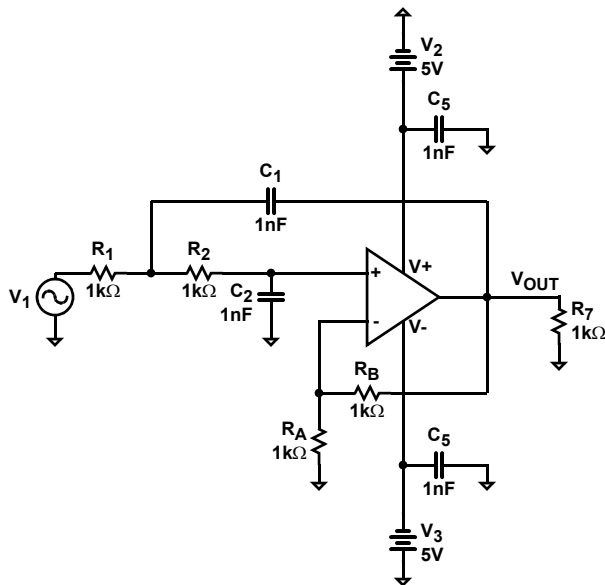


FIGURE 29. SALLEN KEY HIGH PASS FILTER

$$H_{olp} = K$$

$$\omega_o = \frac{1}{\sqrt{R_1 C_1 R_2 C_2}}$$

$$Q = \frac{1}{(1 - K)\sqrt{\frac{R_1 C_1}{R_2 C_2}} + \sqrt{\frac{R_1 C_2}{R_2 C_1}} + \sqrt{\frac{R_2 C_2}{R_1 C_1}}}$$

Equations simplify if we let all components be equal R=C

$$H_{olp} = \frac{K}{4 - K}$$

$$\omega_o = \frac{\sqrt{2}}{RC}$$

$$Q = \frac{\sqrt{2}}{4 - K}$$

ISL55004

Differential Output Instrumentation Amplifier

The addition of a third amplifier to the conventional three amplifier instrumentation amplifier introduces the benefits of differential signal realization, specifically the advantage of using common-mode rejection to remove coupled noise and ground potential errors inherent in remote transmission. This configuration also provides enhanced bandwidth, wider output swing and faster slew rate than conventional three amplifier solutions with only the cost of an additional amplifier and few resistors.

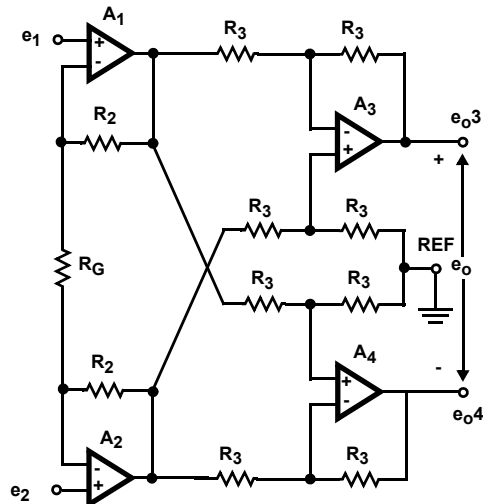


FIGURE 30. DIFFERENTIAL OUTPUT AMPLIFIER

$$e_{o3} = -(1 + 2R_2/R_G)(e_1 - e_2) \quad e_{o4} = (1 + 2R_2/R_G)(e_1 - e_2)$$

$$e_o = -2(1 + 2R_2/R_G)(e_1 - e_2)$$

$$BW = \frac{2f_{C1,2}}{|A_{Di}|} \quad A_{Di} = -2(1 + 2R_2/R_G)$$

Strain Gauge

The strain gauge is an ideal application to take advantage of the moderate bandwidth and high accuracy of the ISL55004. The operation of the circuit is very straightforward. As the strain variable component resistor in the balanced bridge is subjected to increasing strain, its resistance changes, resulting in an imbalance in the bridge. A voltage variation from the referenced high accuracy source is generated and translated to the difference amplifier through the buffer stage. This voltage difference as a function of the strain is converted into an output voltage.

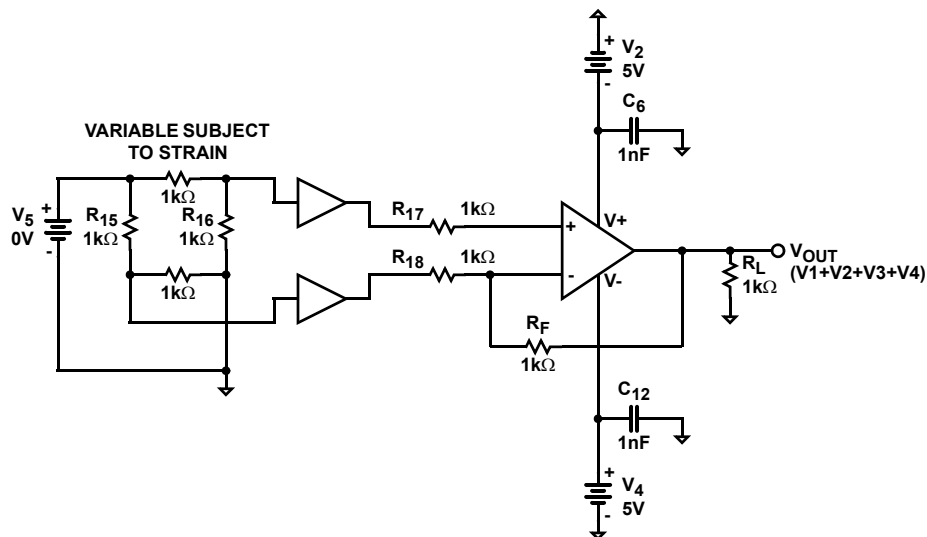
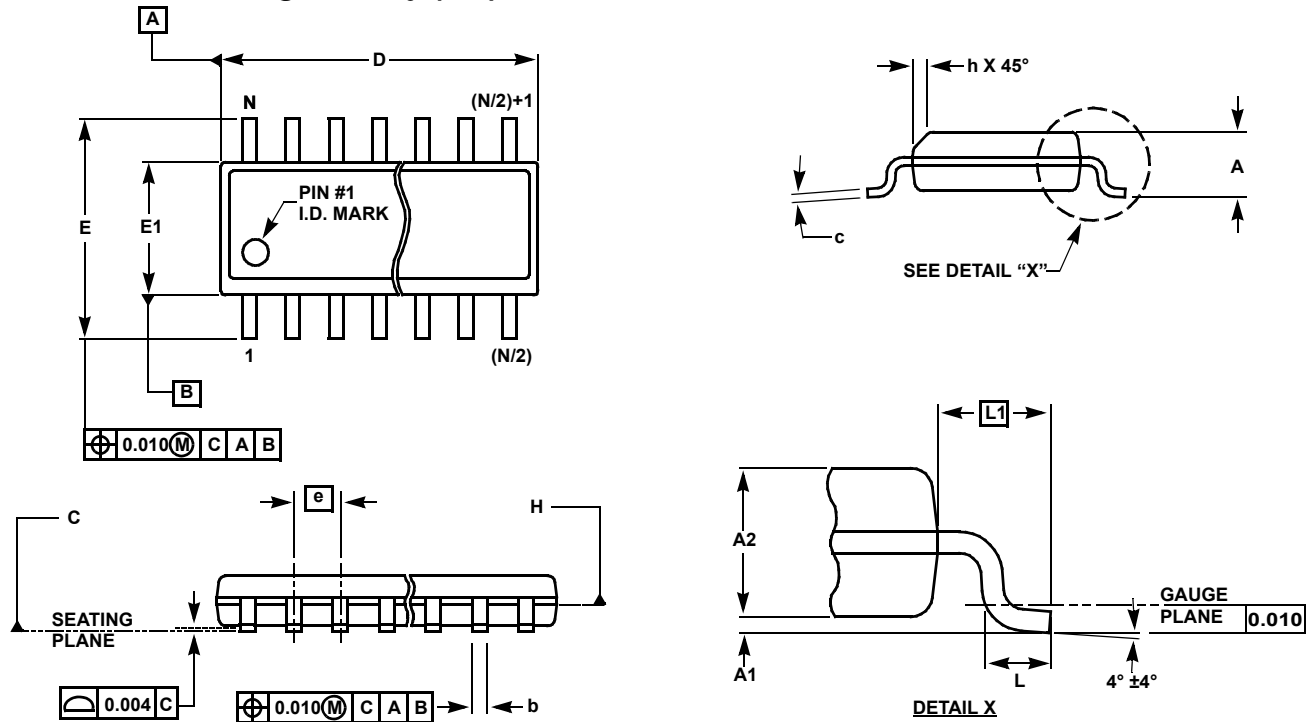


FIGURE 31. STRAIN GAUGE

ISL55004

Small Outline Package Family (SO)

MDP0027
SMALL OUTLINE PACKAGE FAMILY (SO)

SYMBOL	SO-8	SO-14	SO16 (0.150")	SO16 (0.300") (SOL-16)	SO20 (SOL-20)	SO24 (SOL-24)	SO28 (SOL-28)	TOLERANCE	NOTES
A	0.068	0.068	0.068	0.104	0.104	0.104	0.104	MAX	-
A1	0.006	0.006	0.006	0.007	0.007	0.007	0.007	±0.003	-
A2	0.057	0.057	0.057	0.092	0.092	0.092	0.092	±0.002	-
b	0.017	0.017	0.017	0.017	0.017	0.017	0.017	±0.003	-
c	0.009	0.009	0.009	0.011	0.011	0.011	0.011	±0.001	-
D	0.193	0.341	0.390	0.406	0.504	0.606	0.704	±0.004	1, 3
E	0.236	0.236	0.236	0.406	0.406	0.406	0.406	±0.008	-
E1	0.154	0.154	0.154	0.295	0.295	0.295	0.295	±0.004	2, 3
e	0.050	0.050	0.050	0.050	0.050	0.050	0.050	Basic	-
L	0.025	0.025	0.025	0.030	0.030	0.030	0.030	±0.009	-
L1	0.041	0.041	0.041	0.056	0.056	0.056	0.056	Basic	-
h	0.013	0.013	0.013	0.020	0.020	0.020	0.020	Reference	-
N	8	14	16	16	20	24	28	Reference	-

Rev. L 2/01

NOTES:

1. Plastic or metal protrusions of 0.006" maximum per side are not included.
2. Plastic interlead protrusions of 0.010" maximum per side are not included.
3. Dimensions "D" and "E1" are measured at Datum Plane "H".
4. Dimensioning and tolerancing per ASME Y14.5M-1994

OUR CERTIFICATE

DiGi provide top-quality products and perfect service for customer worldwide through standardization, technological innovation and continuous improvement. DiGi through third-party certification, we stricly control the quality of products and services. Welcome your RFQ to

Email: Info@DiGi-Electronics.com



Tel: +00 852-30501935

RFQ Email: Info@DiGi-Electronics.com

DiGi is a global authorized distributor of electronic components.