

RT9721AGB Datasheet

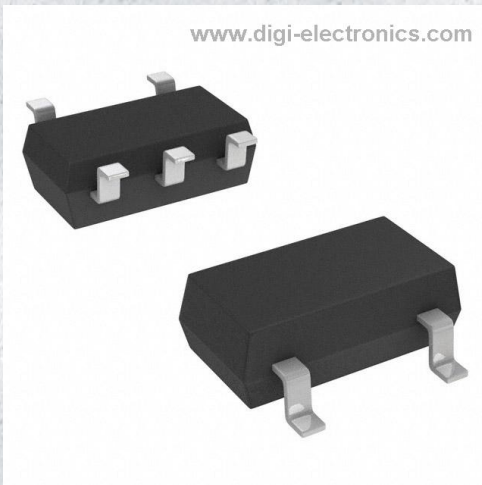

DiGi Electronics Part Number	RT9721AGB-DG
Manufacturer	Richtek USA Inc.
Manufacturer Product Number	RT9721AGB
Description	IC PWR SWITCH N-CHAN 1:1 SOT23-5
Detailed Description	Power Switch/Driver 1:1 N-Channel 500mA SOT-23-5



Tel: +00 852-30501935

RFQ Email: Info@DiGi-Electronics.com

DiGi is a global authorized distributor of electronic components.

Purchase and inquiry

Manufacturer Product Number:

RT9721AGB

Series:

-

Switch Type:

USB Switch

Ratio - Input:Output:

1:1

Output Type:

N-Channel

Voltage - Load:

2.5V ~ 5.5V

Current - Output (Max):

500mA

Input Type:

Non-Inverting

Fault Protection:

Current Limiting (Fixed), Over Temperature, Reverse Current, UVLO

Mounting Type:

Surface Mount

Package / Case:

SC-74A, SOT-753

Manufacturer:

Richtek USA Inc.

Product Status:

Active

Number of Outputs:

1

Output Configuration:

High Side

Interface:

On/Off

Voltage - Supply (Vcc/Vdd):

Not Required

Rds On (Typ):

80mOhm

Features:

Status Flag

Operating Temperature:

-40°C ~ 125°C (TJ)

Supplier Device Package:

SOT-23-5

Base Product Number:

RT9721

Environmental & Export classification

RoHS Status:

ROHS3 Compliant

REACH Status:

REACH Unaffected

HTSUS:

8542.39.0001

Moisture Sensitivity Level (MSL):

3 (168 Hours)

ECCN:

EAR99

80mΩ, 500mA High-Side Power Switches with Flag

General Description

The RT9721A/B are low voltage, single N-MOSFET high-side power switches, optimized for self-powered and bus-powered Universal Serial Bus (USB) applications. The RT9721A/B series provides a charge pump circuitry to drive the internal MOSFET switch; the switch's low $R_{DS(ON)}$, 80mΩ, meets USB voltage drop requirements; and a flag output is available to indicate fault conditions to the local USB controller.

Additional features include soft-start to limit inrush current during plug-in, thermal shutdown to prevent catastrophic switch failure from high-current loads, under-voltage lockout (UVLO) to ensure that the device remains off unless there is a valid input voltage present. The maximum current is limited to typically 750mA in dual ports in accordance with the USB power requirements, lower quiescent current as 50uA making this device ideal for portable battery-operated equipment.

The RT9721A is designed without output auto-discharge function and RT9721B is designed with output auto-discharge function.

The RT9721A/B are available in SOT-23-5 package requiring minimum board space and smallest components.

Ordering Information

RT9721	□	□	□
	—	—	—
	Package Type		
	B : SOT-23-5		
	Lead Plating System		
	G : Green (Halogen Free and Pb Free)		
	Output Discharge Function		
	A : Without Auto-Discharge Function		
	B : With Auto-Discharge Function		

Note :

Richtek products are :

- ▶ RoHS compliant and compatible with the current requirements of IPC/JEDEC J-STD-020.
- ▶ Suitable for use in SnPb or Pb-free soldering processes.

Features

- Compliant to USB Specifications
- Built-In N-MOSFET
 - ▶ Typical $R_{DS(ON)}$: 80mΩ
- Output Can Be Forced to Higher Than Input (Off-State)
- Low Supply Current :
 - ▶ 50μA Typical at Switch On State
 - ▶ 0.1μA Typical at Switch Off State
- Guaranteed 500mA Continuous Load Current
- Wide Input Voltage Ranges : 2.5V to 5.5V
- Open-Drain Fault Flag Output
- Hot Plug-In Application (Soft-Start)
- 2.15V Typical Under-Voltage Lockout (UVLO)
- Current Limiting Protection
- Thermal Shutdown Protection
- Reverse Current Flow Blocking (no body diode)
- UL Approved—E219878 
- RoHS Compliant and Halogen Free

Applications

- USB Bus/Self Powered Hubs
- USB Peripherals
- Notebook, Motherboard PCs

Pin Configurations

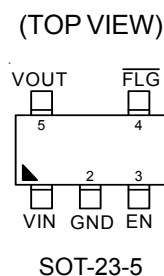

Marking Information

For marking information, contact our sales representative directly or through a Richtek distributor located in your area.

RT9721A/B



Typical Application Circuit

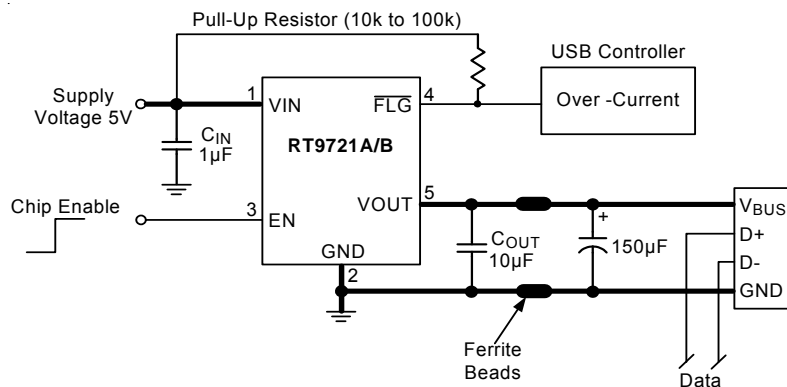

Part Status

Part No	Status	Package Type	Lead plating System
RT9721AGB	Active	SOT-23-5	Green (Halogen Free and Pb Free)
RT9721BGB	Obsolete	SOT-23-5	Green (Halogen Free and Pb Free)

The part status values are defined as follows:

Active: Device is in production and is recommended for new designs.

Lifebuy: The device will be discontinued, and a lifetime-buy period is in effect.

NRND: Not recommended for new designs.

Preview: Device has been announced but is not in production.

Obsolete: Richtek has discontinued the production of the device.

Functional Pin Description

Pin No.	Pin Name	Pin Function
1	VIN	Switch Input Voltage.
2	GND	Ground.
3	EN	Chip Enable (Active High).
4	FLG	Open-Drain Fault Flag Output.
5	VOUT	Switch Output Voltage.

Function Block Diagram

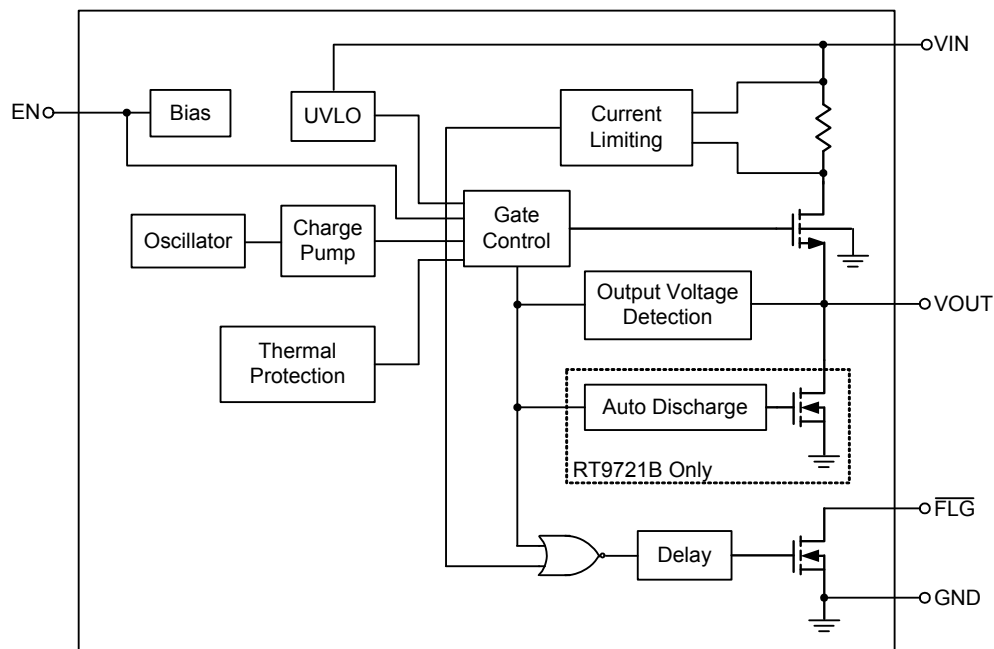

Absolute Maximum Ratings (Note 1)

• Supply Input Voltage, V_{IN}	6V
• EN Input Voltage	-0.3V to 6V
• Flag Voltage	6V
• Power Dissipation, P_D @ $T_A = 25^\circ\text{C}$	
SOT-23-5	0.4W
• Package Thermal Resistance (Note 2)	
SOT-23-5, θ_{JA}	250°C/W
• Lead Temperature (Soldering, 10 sec.)	260°C
• Junction Temperature	150°C
• Storage Temperature Range	-65°C to 150°C
• ESD Susceptibility (Note 3)	
HBM	4kV
MM	400V

Recommended Operating Conditions (Note 4)

• Supply Input Voltage Range, V_{IN}	2.5V to 5.5V
• EN Input Voltage Range	0V to 5.5V
• Junction Temperature Range	-40°C to 125°C
• Ambient Temperature Range	-40°C to 85°C

Electrical Characteristics

($V_{IN} = 5\text{V}$, $C_{IN} = 1\mu\text{F}$, $C_{OUT} = 10\mu\text{F}$, $T_A = 25^\circ\text{C}$, unless otherwise specified)

Parameter		Symbol	Test Conditions	Min	Typ	Max	Unit
Switch On Resistance		$R_{DS(ON)}$	$V_{IN} = 5\text{V}$, $I_{OUT} = 100\text{mA}$	--	80	100	m Ω
Supply Current		I_{SW_ON}	Switch On, $V_{OUT} = \text{Open}$	--	50	70	μA
		I_{SW_OFF}	Switch Off, $V_{OUT} = \text{Open}$	--	0.1	1	
EN Threshold	Logic-Low Voltage	V_{IL}	$V_{IN} = 2.5\text{V to } 5.5\text{V}$, Switch Off	--	--	0.8	V
	Logic-High Voltage	V_{IH}	$V_{IN} = 2.5\text{V to } 5.5\text{V}$, Switch On	2	--	--	V
EN Input Current		I_{EN}	$V_{EN} = 5\text{V}$	--	0.01	0.1	μA
Output Leakage Current		$I_{LEAKAGE}$	$V_{EN} = 0\text{V}$, $R_{LOAD} = 0\Omega$	--	0.5	1	μA
Output Turn-On Rise Time		T_{ON_RISE}	10% to 90% of V_{OUT} Rising	--	200	--	μs
Current Limit Detect Threshold		$I_{LIM_THRES_HOLD}$	I_{OUT} Rising	--	--	1	A
Current Limit		I_{LIM}	$V_{OUT} = 4\text{V}$	500	--	900	mA
$\overline{\text{FLG}}$ Output Resistance		$R_{\overline{\text{FLG}}}$	$I_{SINK} = 1\text{mA}$	--	10	--	Ω
$\overline{\text{FLG}}$ Off Current		$I_{\overline{\text{FLG}}_OFF}$	$V_{\overline{\text{FLG}}} = 5\text{V}$	--	0.01	1	μA
$\overline{\text{FLG}}$ Delay Time (Note 5)		t_D	From fault condition to $\overline{\text{FLG}}$ assertion	5	12	20	ms
Shutdown Auto-Discharge Resistance		$R_{Discharge}$	$V_{EN} = 0\text{V}$	--	100	150	Ω

Parameter	Symbol	Test Conditions	Min	Typ	Max	Unit
Under-Voltage Lockout	V_{UVLO}	V_{IN} Increasing	1.9	2.15	2.4	V
Under-Voltage Hysteresis	ΔV_{UVLO}	V_{IN} Decreasing	--	0.1	--	V
Thermal Shutdown Protection	T_{SD}		--	150	--	°C
Thermal Shutdown Hysteresis	ΔT_{SD}		--	25	--	°C

Note 1. Stresses listed as the above “Absolute Maximum Ratings” may cause permanent damage to the device. These are for stress ratings. Functional operation of the device at these or any other conditions beyond those indicated in the operational sections of the specifications is not implied. Exposure to absolute maximum rating conditions for extended periods may remain possibility to affect device reliability.

Note 2. θ_{JA} is measured in the natural convection at $T_A = 25^\circ\text{C}$ on a low effective single layer thermal conductivity test board of JEDEC 51-3 thermal measurement standard.

Note 3. Devices are ESD sensitive. Handling precaution is recommended.

Note 4. The device is not guaranteed to function outside its operating conditions.

Note 5. The FLAG delay time is input voltage dependent, see “Typical Operating Characteristics” graph for further details.

Typical Operating Characteristics

On Resistance vs. Input Voltage

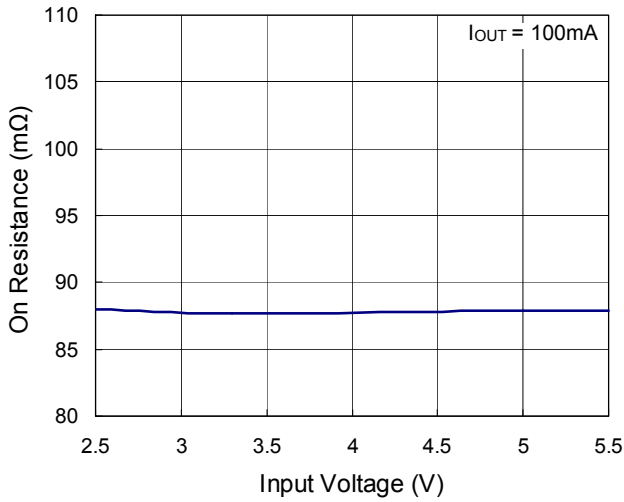

On Resistance vs. Temperature

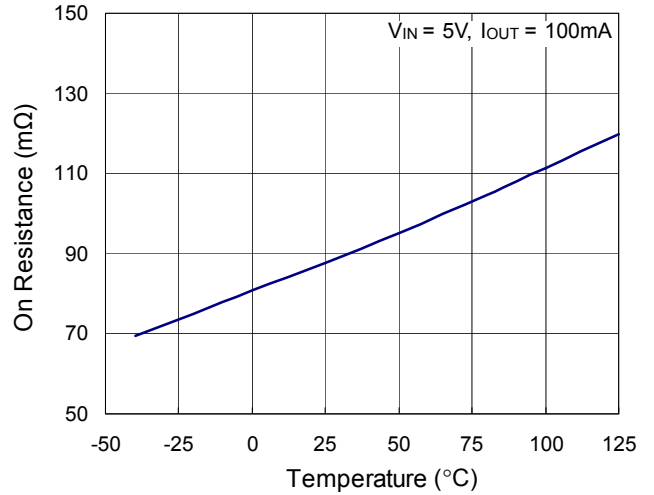

Switch On Supply Current vs. Input Voltage

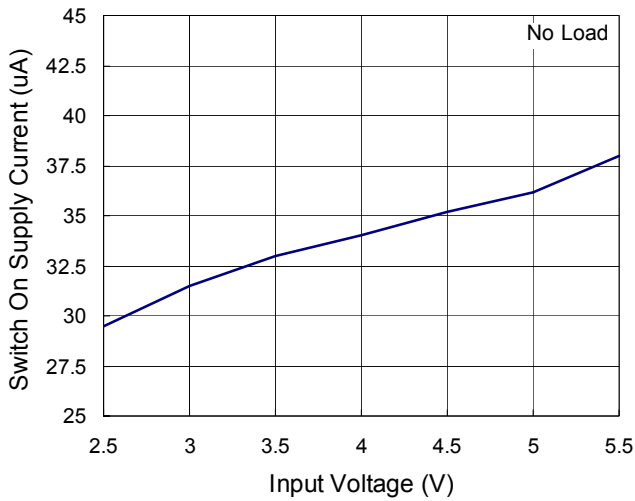

Switch On Supply Current vs. Temperature

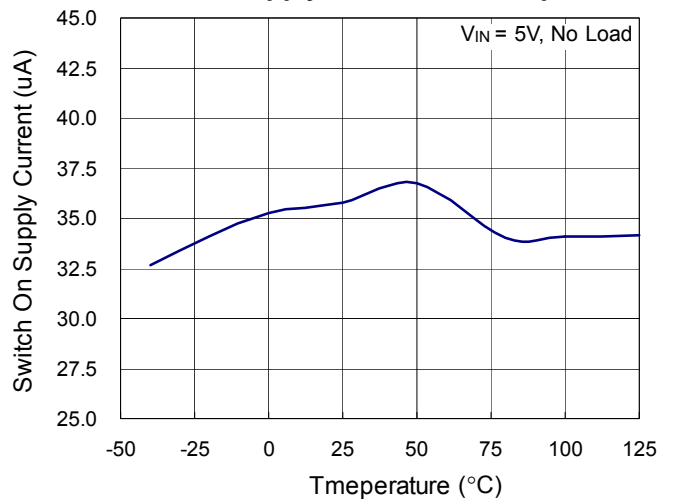

Switch Off Supply Current vs. Input Voltage

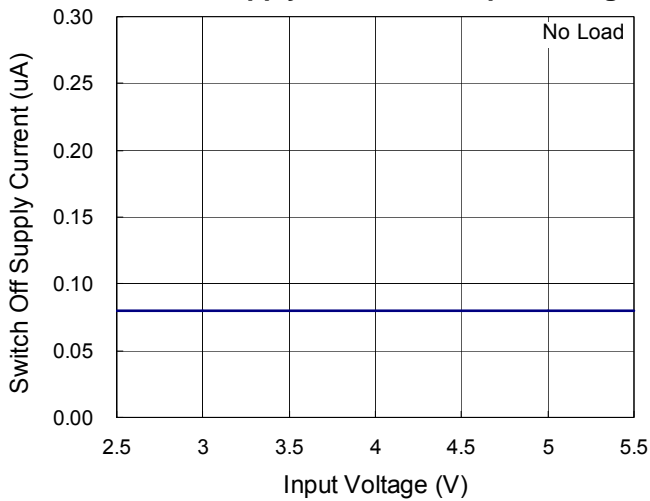

Switch Off Supply Current vs. Temperature

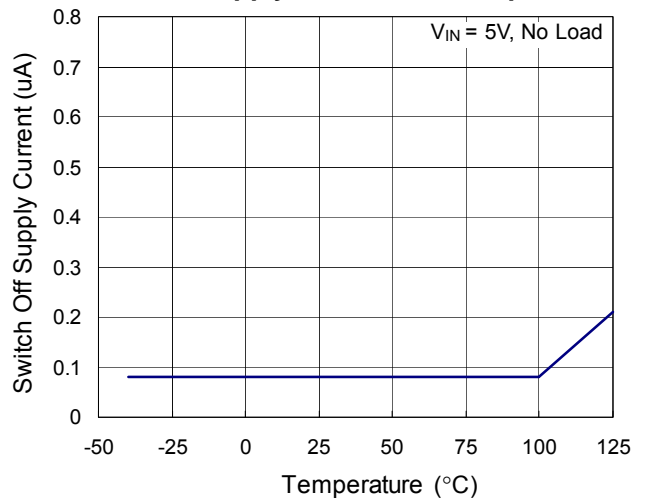

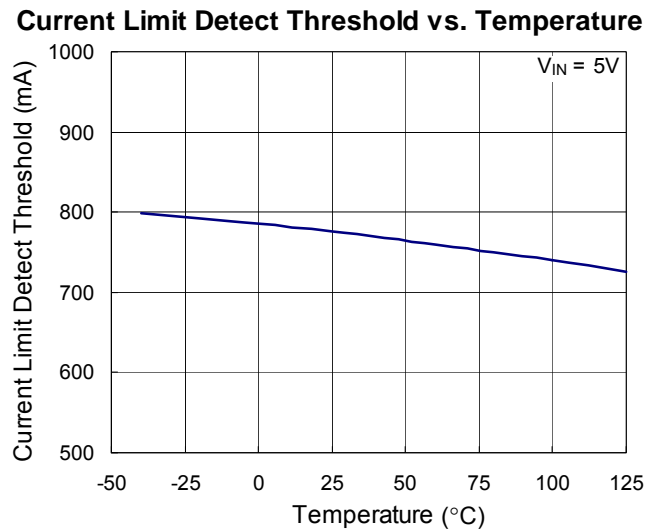
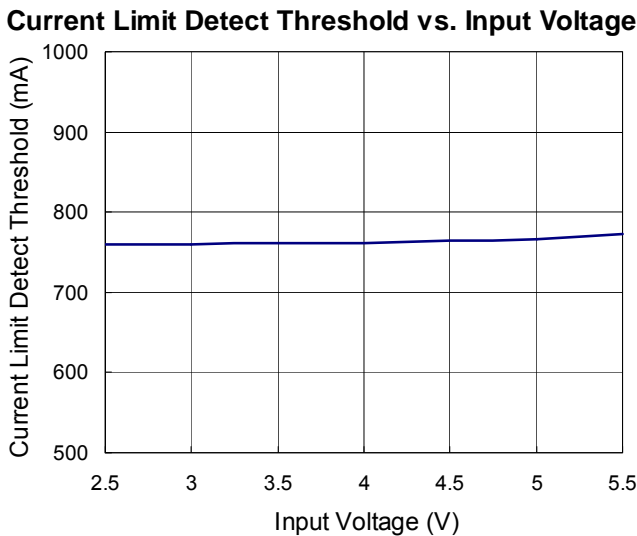
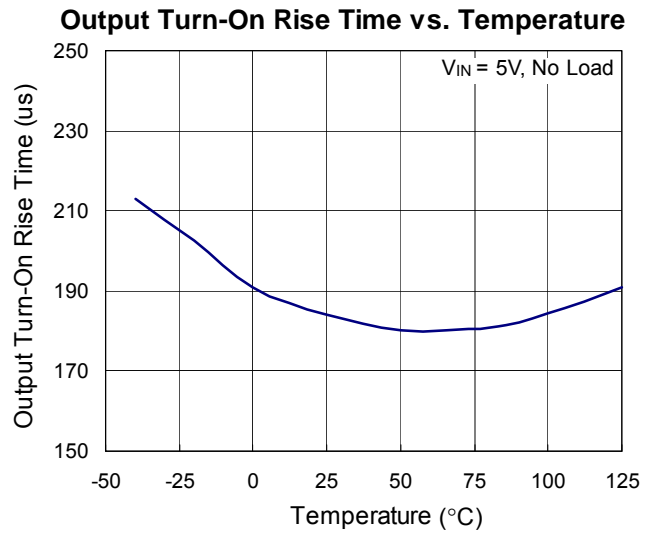
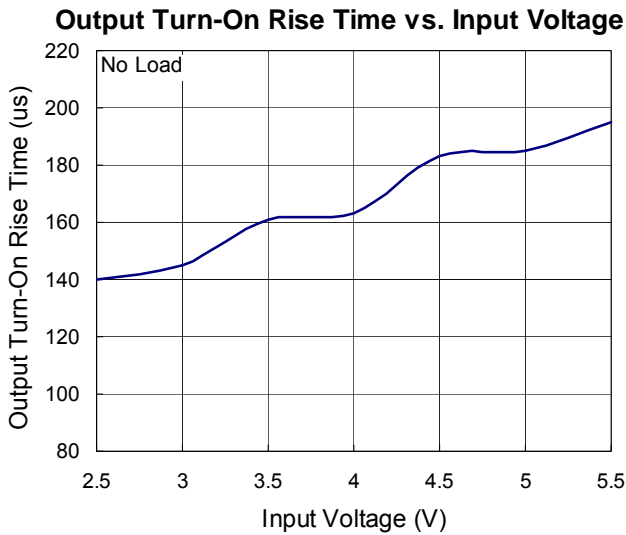
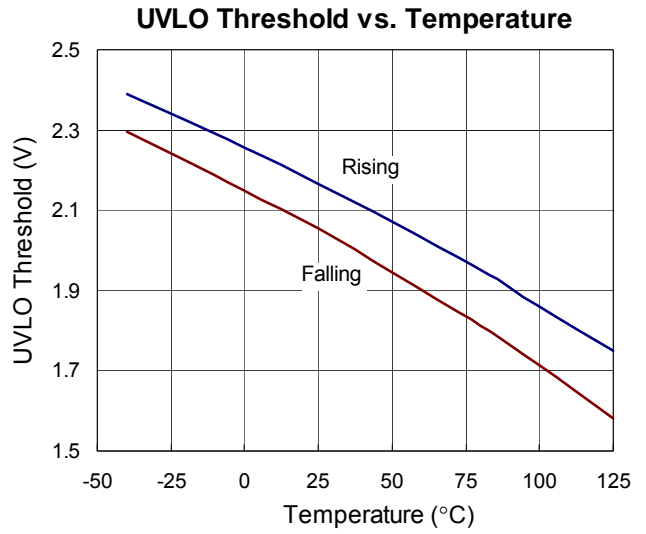
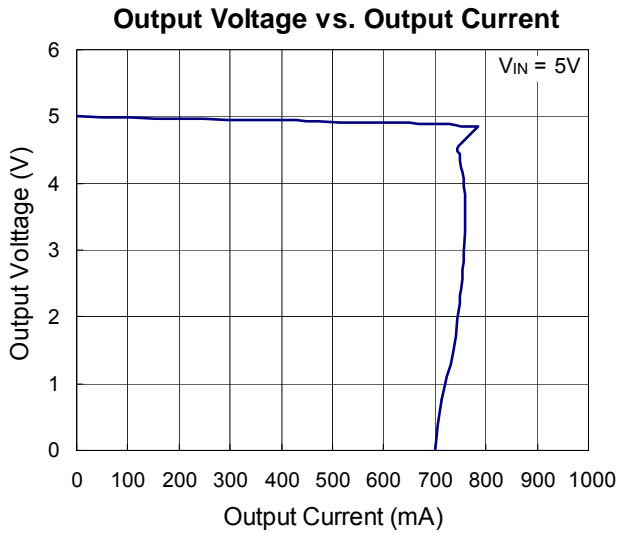

Current Limit vs. Input Voltage

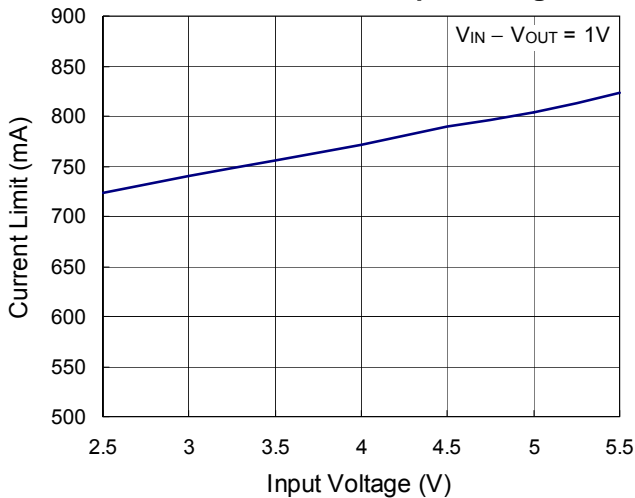

Current Limit vs. Temperature

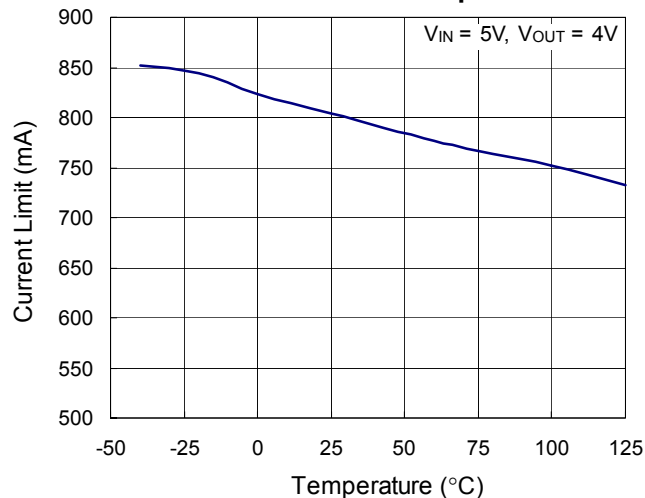

FLAG Delay Time vs. Input Voltage

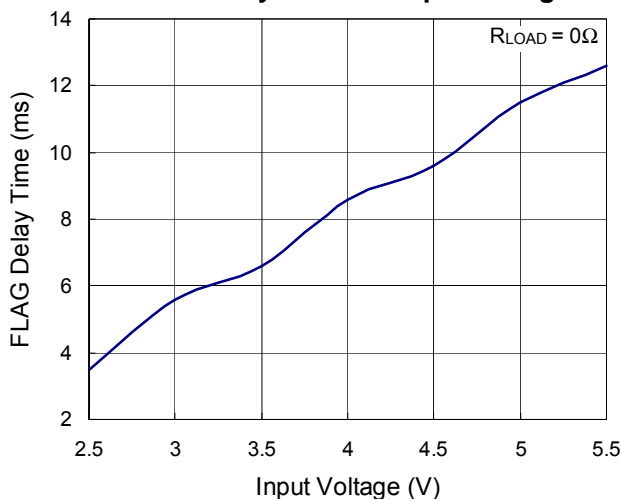

FLAG Delay Time vs. Temperature

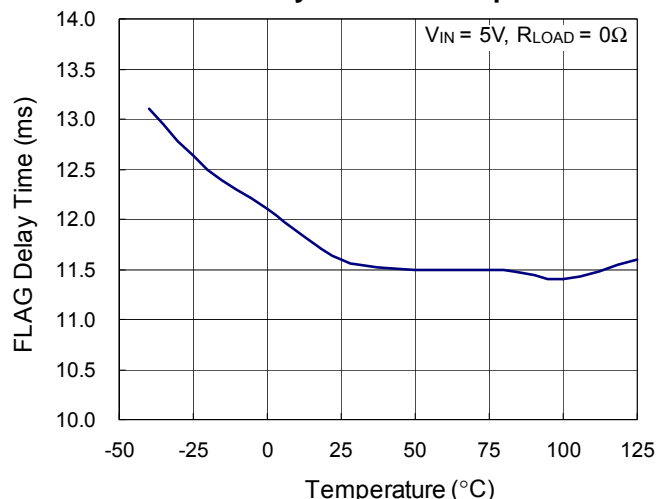

EN Threshold Voltage vs. Input Voltage

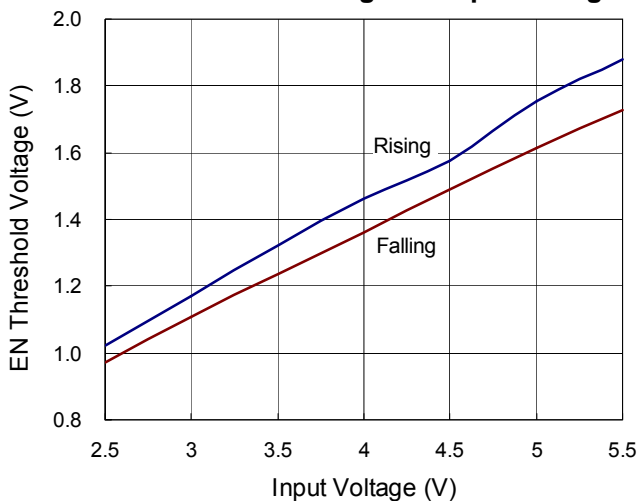

Power On from VIN

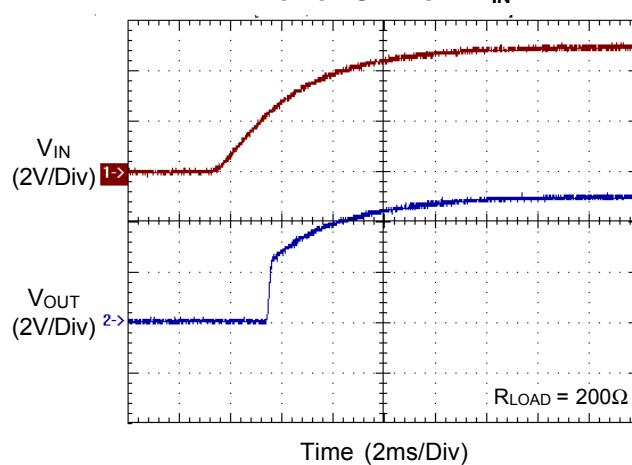

Power Off from V_{IN}

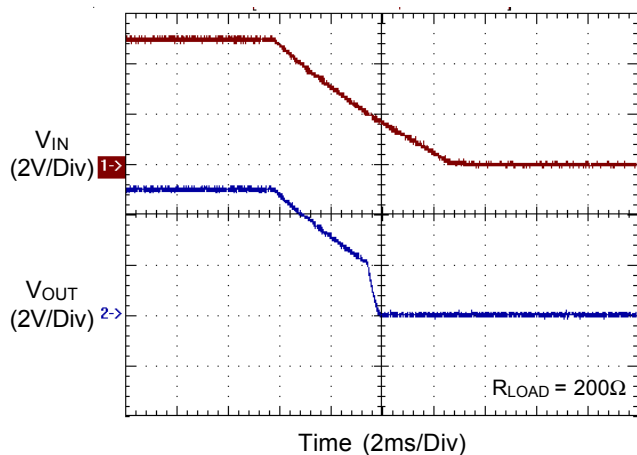

Turn On from EN

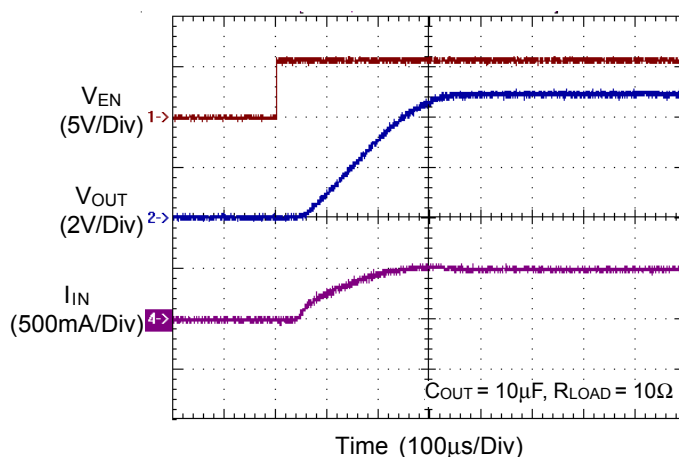

Turn Off from EN

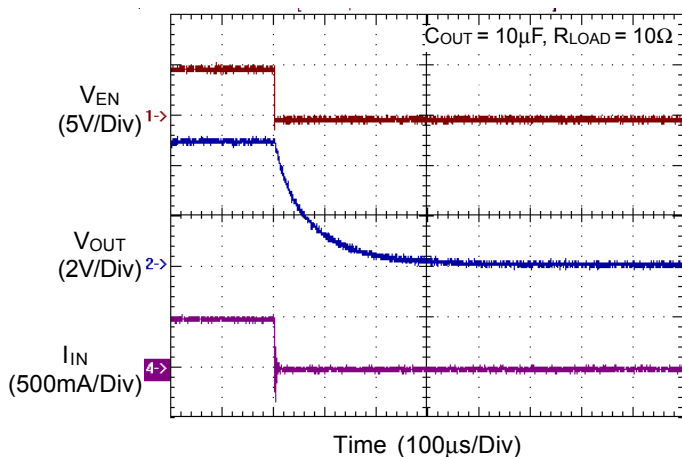

Current Limit Response

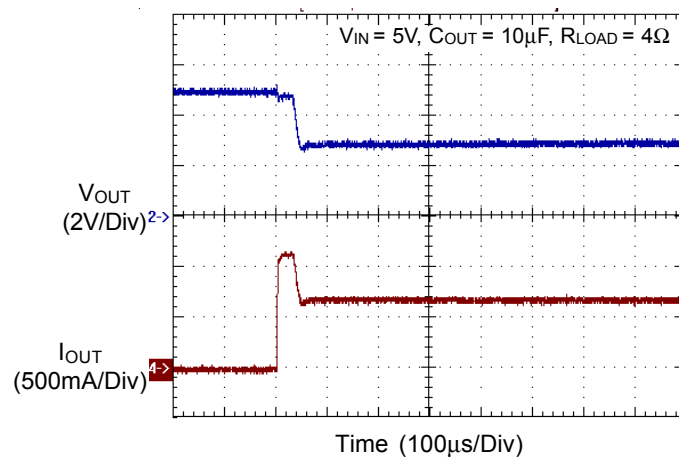

FLAG Response

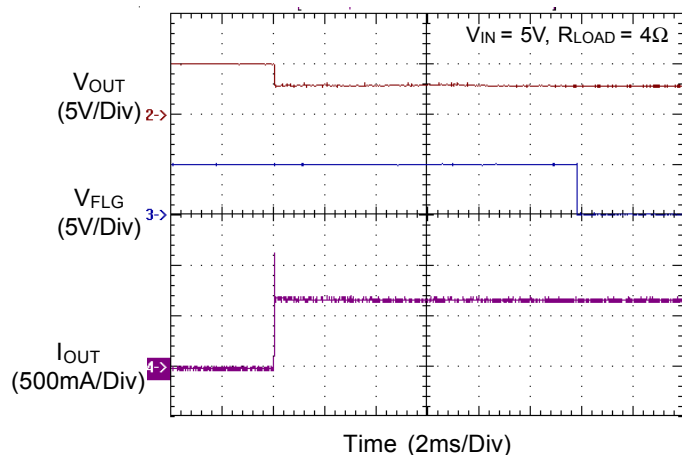

Thermal Shutdown Response

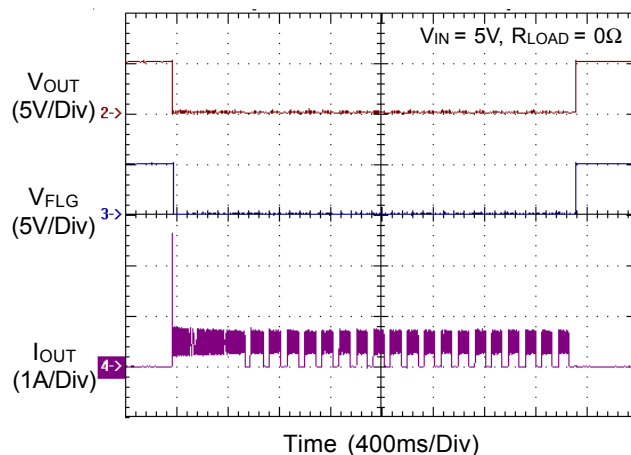

Applications Information

The RT9721A/B are single N-MOSFET high-side power switch with active-high enable input, optimized for self-powered and bus-powered Universal Serial Bus (USB) applications. The RT9721A/B series equipped with a charge pump circuitry to drive the internal N-MOSFET switch; the switch's low $R_{DS(ON)}$, 80m Ω , meets USB voltage drop requirements; and a flag output is available to indicate fault conditions to the local USB controller.

Input and Output

V_{IN} (input) is the power source connection to the internal circuitry and the drain of the MOSFET. V_{OUT} (output) is the source of the MOSFET. In a typical application, current flows through the switch from V_{IN} to V_{OUT} toward the load. If V_{OUT} is greater than V_{IN} , current will flow from V_{OUT} to V_{IN} since the MOSFET is bidirectional when on.

Unlike a normal MOSFET, there is no a parasitic body diode between drain and source of the MOSFET, the RT9721A/B prevent reverse current flow if V_{OUT} being externally forced to a higher voltage than V_{IN} when the chip is disabled ($V_{EN} < 0.8V$).

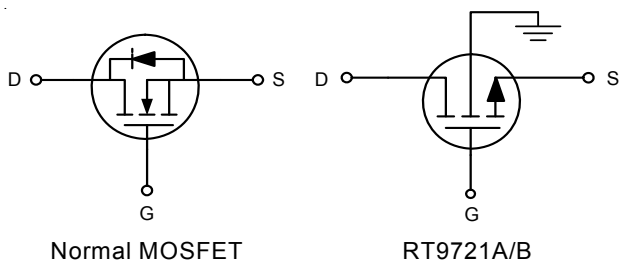

Chip Enable Input

The switch will be disabled when the EN pin is in a logic low condition. During this condition, the internal circuitry and MOSFET are turned off, reducing the supply current to 0.1 μ A typical. The maximum guaranteed voltage for a logic low at the EN pin is 0.8V. A minimum guaranteed voltage of 2V at the EN pin will turn the RT9721A/B on. Floating the input may cause unpredictable operation. EN should not be allowed to go negative with respect to GND.

Soft Start for Hot Plug-In Applications

In order to eliminate the upstream voltage droop caused by the large inrush current during hot-plug events, the

“soft-start” feature effectively isolates the power source from extremely large capacitive loads, satisfying the USB voltage droop requirements.

Fault Flag

The RT9721A/B series provides a \overline{FLG} signal pin which is an N-Channel open drain MOSFET output. This open drain output goes low when $V_{OUT} < V_{IN} - 1V$, current limit or the die temperature exceeds 150°C approximately. The \overline{FLG} output is capable of sinking a 10mA load to typically 200mV above ground. The \overline{FLG} pin requires a pull-up resistor, this resistor should be large in value to reduce energy drain. A 100k Ω pull-up resistor works well for most applications. In the case of an over-current condition, \overline{FLG} will be asserted only after the flag response delay time, t_D , has elapsed. This ensures that \overline{FLG} is asserted only upon valid over-current conditions and that erroneous error reporting is eliminated.

For example, false over-current conditions may occur during hot-plug events when extremely large capacitive loads are connected and causes a high transient inrush current that exceeds the current limit threshold. The \overline{FLG} response delay time t_D is typically 12ms.

Under-Voltage Lockout

Under-voltage lockout (UVLO) prevents the MOSFET switch from turning on until input voltage exceeds approximately 2.15V. If input voltage drops below approximately 2.05V, UVLO turns off the MOSFET switch, \overline{FLG} will be asserted accordingly. Under-voltage detection functions only when the switch is enabled.

Current Limiting Protection

The current limit circuitry prevents damage to the MOSFET switch and the hub downstream port but can deliver load current up to the current limit threshold of typically 700mA through the switch of RT9721A/B series. When a heavy load or short circuit is applied to an enabled switch, a large transient current may flow until the current limit circuitry responds. Once this current limit threshold is exceeded, the device enters constant current mode until the thermal shutdown occurs or the fault is removed.

Thermal Shutdown

Thermal shutdown is employed to protect the device from damage if the die temperature exceeds approximately 150°C. The power switch will auto-recover when the IC is cooling down. The thermal hysteresis temperature is about 25°C.

Universal Serial Bus (USB) & Power Distribution

The goal of USB is to enable devices from different vendors to interoperate in an open architecture. USB features include ease of use for the end user, a wide range of workloads and applications, robustness, synergy with the PC industry, and low-cost implementation. Benefits include self-identifying peripherals, dynamically attachable and reconfigurable peripherals, multiple connections (support for concurrent operation of many devices), support for as many as 127 physical devices, and compatibility with PC Plug-and-Play architecture.

The Universal Serial Bus connects USB devices with a USB host: each USB system has one USB host. USB devices are classified either as hubs, which provide additional attachment points to the USB, or as functions, which provide capabilities to the system (for example, a digital joystick). Hub devices are then classified as either Bus-Power Hubs or Self-Powered Hubs.

A Bus-Powered Hub draws all of the power to any internal functions and downstream ports from the USB connector power pins. The hub may draw up to 500mA from the upstream device. External ports in a Bus-Powered Hub can supply up to 100mA per port, with a maximum of four external ports.

Self-Powered Hub power for the internal functions and downstream ports does not come from the USB, although the USB interface may draw up to 100mA from its upstream connect, to allow the interface to function when the remainder of the hub is powered down. The hub must be able to supply up to 500mA on all of its external downstream ports. Please refer to Universal Serial Specification Revision 2.0 for more details on designing compliant USB hub and host systems.

Over-Current protection devices such as fuses and PTC resistors (also called polyfuse or polyswitch) have slow trip times, high on-resistance, and lack the necessary

circuitry for USB-required fault reporting.

The faster trip time of the RT9721A/B power distribution allow designers to design hubs that can operate through faults. The RT9721A/B have low on-resistance and internal fault-reporting circuitry that help the designer to meet voltage regulation and fault notification requirements.

Because the devices are also power switches, the designer of self-powered hubs has the flexibility to turn off power to output ports. Unlike a normal MOSFET, the devices have controlled rise and fall times to provide the needed inrush current limiting required for the bus-powered hub power switch.

Supply Filter/Bypass Capacitor

A 1uF low-ESR ceramic capacitor from VIN to GND, located at the device is strongly recommended to prevent the input voltage drooping during hot-plug events. However, higher capacitor values will further reduce the voltage droop on the input. Furthermore, without the bypass capacitor, an output short may cause sufficient ringing on the input (from source lead inductance) to destroy the internal control circuitry. The input transient must not exceed 6.5V of the absolute maximum supply voltage even for a short duration.

Output Filter Capacitor

A low-ESR 150uF aluminum electrolytic or tantalum between VOUT and GND is strongly recommended to meet the 330mV maximum droop requirement in the hub VBUS (Per USB 2.0, output ports must have a minimum 120uF of low-ESR bulk capacitance per hub). Standard bypass methods should be used to minimize inductance and resistance between the bypass capacitor and the downstream connector to reduce EMI and decouple voltage droop caused when downstream cables are hot-insertion transients. Ferrite beads in series with VBUS, the ground line and the 0.1μF bypass capacitors at the power connector pins are recommended for EMI and ESD protection. The bypass capacitor itself should have a low dissipation factor to allow decoupling at higher frequencies.

Voltage Drop

The USB specification states a minimum port-output voltage in two locations on the bus, 4.75V output of a

RT9721A/B

RICHTEK

Self-Powered Hub port and 4.4V output of a Bus-Powered Hub port. As with the Self-Powered Hub, all resistive voltage drops for the Bus-Powered Hub must be accounted for to guarantee voltage regulation (see Figure 7-47 of Universal Serial Specification Revision 2.0).

The following calculation determines $V_{OUT(MIN)}$ for multiple ports (N_{PORTS}) ganged together through one switch (if using one switch per port, N_{PORTS} is equal to 1):

$$V_{OUT(MIN)} = 4.75V - [I_L \times (4 \times R_{CONN} + 2 \times R_{CABLE})] - (0.1A \times N_{PORTS} \times R_{SWITCH}) - V_{PCB}$$

Where

R_{CONN} : Resistance of connector contacts (two contacts per connector)

R_{CABLE} : Resistance of upstream cable wires (one 5V and one GND)

R_{SWITCH} : Resistance of power switch (80mΩ typical for RT9721A/B)

V_{PCB} : PCB voltage drop

The USB specification defines the maximum resistance per contact (R_{CONN}) of the USB connector to be 30mΩ and the drop across the PCB and switch to be 100mV. This basically leaves two variables in the equation: the resistance of the switch and the resistance of the cable.

If the hub consumes the maximum current (I_L) of 500mA, the maximum resistance of the cable is 90mΩ.

The resistance of the switch is defined as follows:

$$R_{SWITCH} = \{ 4.75V - 4.4V - [0.5A \times (4 \times 30m\Omega + 2 \times 90m\Omega)] - V_{PCB} \} / (0.1A \times N_{PORTS}) \\ = (200mV - V_{PCB}) / (0.1A \times N_{PORTS})$$

If the voltage drop across the PCB is limited to 100mV, the maximum resistance for the switch is 250mΩ for four ports ganged together. The RT9721A/B, with its maximum 110mΩ on-resistance over temperature, easily meets this requirement.

Thermal Considerations

For continuous operation, do not exceed absolute maximum operation junction temperature. The maximum power dissipation depends on the thermal resistance of IC package, PCB layout, the rate of surroundings airflow

and temperature difference between junction to ambient. The maximum power dissipation can be calculated by following formula:

$$P_{D(MAX)} = (T_{J(MAX)} - T_A) / \theta_{JA}$$

Where $T_{J(MAX)}$ is the maximum operation junction temperature, T_A is the ambient temperature and the θ_{JA} is the junction to ambient thermal resistance.

For recommended operating conditions specification of RT9721A/B, the maximum junction temperature is 125°C. The junction to ambient thermal resistance θ_{JA} is layout dependent. For SOT-23-5 package, the thermal resistance θ_{JA} is 250°C/W on the standard JEDEC 51-3 single layer thermal test board. The maximum power dissipation at $T_A = 25^\circ\text{C}$ can be calculated by following formula:

$$P_{D(MAX)} = (125^\circ\text{C} - 25^\circ\text{C}) / (250^\circ\text{C/W}) = 0.4W \text{ for SOT-23-5 package}$$

The maximum power dissipation depends on operating ambient temperature for fixed $T_{J(MAX)}$ and thermal resistance θ_{JA} . For the RT9721A/B, Figure 1 shows the maximum power dissipation allowed under various ambient temperatures.

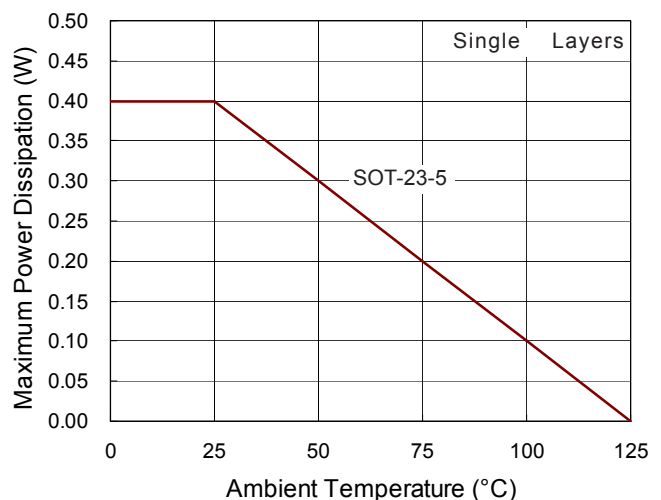

Figure 1. Maximum Power Dissipation Derating Curve

Layout Considerations

For best performance of the RT9721A/B series, the following guidelines must be strictly followed.

- ▶ Input and output capacitors should be placed close to the IC and connected to ground plane to reduce noise coupling.
- ▶ The GND should be connected to a strong ground plane for heat sink.
- ▶ Keep the main current traces as possible as short and wide.

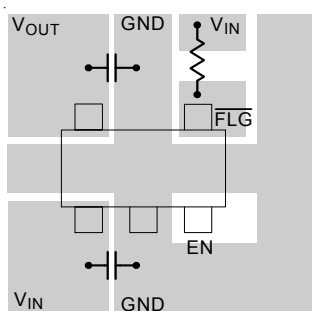
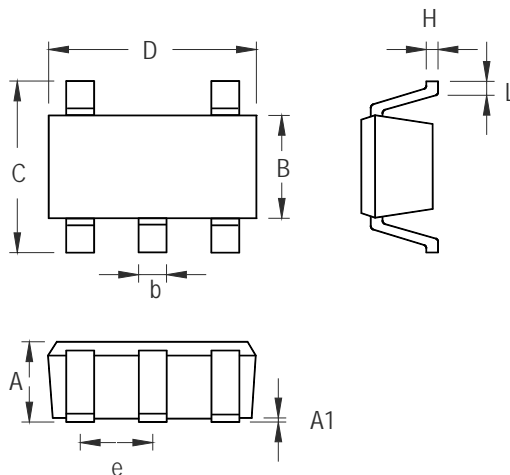

Figure 2

RT9721A/B

RICHTEK

Outline Dimension



Symbol	Dimensions In Millimeters		Dimensions In Inches	
	Min	Max	Min	Max
A	0.889	1.295	0.035	0.051
A1	0.000	0.152	0.000	0.006
B	1.397	1.803	0.055	0.071
b	0.356	0.559	0.014	0.022
C	2.591	2.997	0.102	0.118
D	2.692	3.099	0.106	0.122
e	0.838	1.041	0.033	0.041
H	0.080	0.254	0.003	0.010
L	0.300	0.610	0.012	0.024

SOT-23-5 Surface Mount Package

Richtek Technology Corporation

14F, No. 8, Tai Yuen 1st Street, Chupei City

Hsinchu, Taiwan, R.O.C.

Tel: (8863)5526789

RICHTEK

Richtek products are sold by description only. Richtek reserves the right to change the circuitry and/or specifications without notice at any time. Customers should obtain the latest relevant information and data sheets before placing orders and should verify that such information is current and complete. Richtek cannot assume responsibility for use of any circuitry other than circuitry entirely embodied in a Richtek product. Information furnished by Richtek is believed to be accurate and reliable. However, no responsibility is assumed by Richtek or its subsidiaries for its use; nor for any infringements of patents or other rights of third parties which may result from its use. No license is granted by implication or otherwise under any patent or patent rights of Richtek or its subsidiaries.

OUR CERTIFICATE

DiGi provide top-quality products and perfect service for customer worldwide through standardization, technological innovation and continuous improvement. DiGi through third-party certification, we stricly control the quality of products and services. Welcome your RFQ to

Email: Info@DiGi-Electronics.com



Tel: +00 852-30501935

RFQ Email: Info@DiGi-Electronics.com

DiGi is a global authorized distributor of electronic components.