

RT9741DGV Datasheet

www.digi-electronics.com

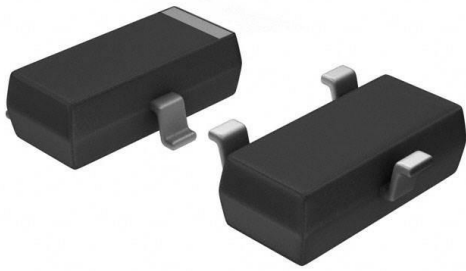

<https://www.DiGi-Electronics.com>

DiGi Electronics Part Number	RT9741DGV-DG
Manufacturer	Richtek USA Inc.
Manufacturer Product Number	RT9741DGV
Description	IC PWR SWITCH N-CHAN 1:1 SOT23-3
Detailed Description	Power Switch/Driver 1:1 N-Channel SOT-23-3



Tel: +00 852-30501935

RFQ Email: Info@DiGi-Electronics.com

DiGi is a global authorized distributor of electronic components.

Purchase and inquiry

Manufacturer Product Number:

RT9741DGV

Series:

-

Switch Type:

USB Switch

Ratio - Input:Output:

1:1

Output Type:

N-Channel

Voltage - Load:

2.7V ~ 5.5V

Current - Output (Max):

-

Input Type:

-

Fault Protection:

-

Mounting Type:

Surface Mount

Package / Case:

TO-236-3, SC-59, SOT-23-3

Manufacturer:

Richtek USA Inc.

Product Status:

Obsolete

Number of Outputs:

1

Output Configuration:

High Side

Interface:

On/Off

Voltage - Supply (Vcc/Vdd):

Not Required

Rds On (Typ):

-

Features:

-

Operating Temperature:

-40°C ~ 85°C (TA)

Supplier Device Package:

SOT-23-3

Base Product Number:

RT9741

Environmental & Export classification

RoHS Status:

ROHS3 Compliant

REACH Status:

REACH Unaffected

HTSUS:

0000.00.0000

Moisture Sensitivity Level (MSL):

3 (168 Hours)

ECCN:

OBSOLETE

100mΩ, 1.5A/0.7A High-Side Power Switches

General Description

The RT9741 is a cost-effective, low-voltage, single N-MOSFET high-side Power Switch IC for USB application. Low switch-on resistance (typ. 100mΩ) and low supply current (typ. 50μA) are realized in this IC.

The RT9741 integrates an over-current protection circuit, a short fold back circuit, a thermal shutdown circuit and an under-voltage lockout circuit for overall protection. Furthermore, the chip also integrates an embedded delay function to prevent miss-operation from happening due to inrush-current. The RT9741 is an ideal solution for USB power supply and can support flexible applications since it is available in the SOT-23-3 package.

Ordering Information

RT9741	□	□	□
	—	—	—
	Package Type		
	V : SOT-23-3		
	Lead Plating System		
	G : Green (Halogen Free and Pb Free)		
	Output Current		
	A : 1.5A		
	C : 0.7A		

Note :

Richtek products are :

- ▶ RoHS compliant and compatible with the current requirements of IPC/JEDEC J-STD-020.
- ▶ Suitable for use in SnPb or Pb-free soldering processes.

Features

- 100mΩ (typ.) N-MOSFET Switch
- Operating Range : 2.7V to 5.5V
- Reverse Blocking Current
- Under-Voltage Lockout
- Thermal Protection with Foldback
- Over-Current Protection
- Short-Circuit Protection
- RoHS Compliant and Halogen Free

Applications

- USB Peripherals
- Notebook PCs

Marking Information

RT9741AGV

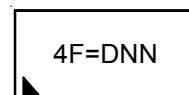

4F= : Product Code
DNN : Date Code

RT9741CGV

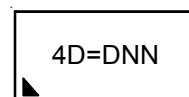

4D= : Product Code
DNN : Date Code

Simplified Application Circuit

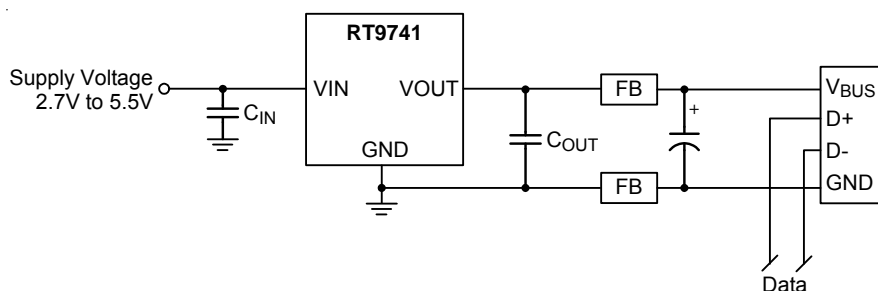

RT9741

RICHTEK

Pin Configurations

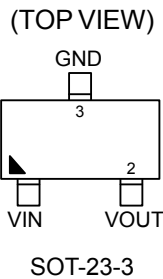

Functional Pin Description

Pin No.	Pin Name	Pin Description
1	VIN	Power Input.
2	VOUT	Output Voltage.
3	GND	Ground.

Function Block Diagram

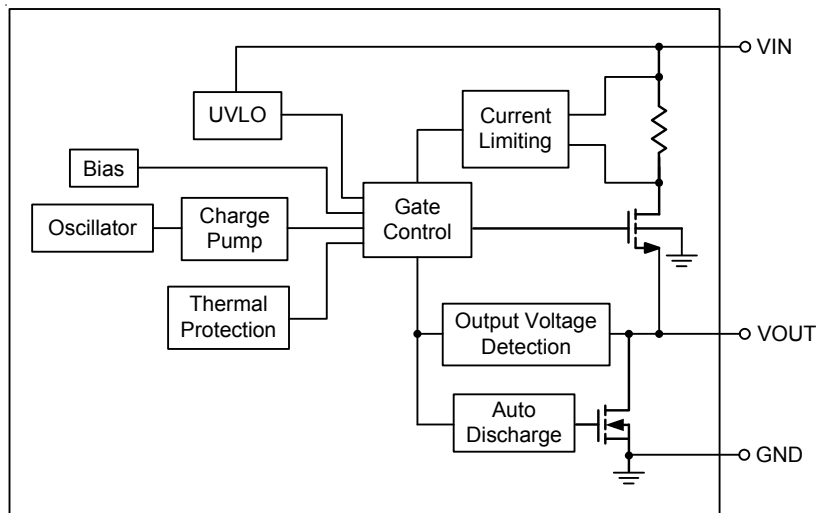

Operation

Charge Pumps and Drivers

An internal charge pump supplies power to the driver circuit and provides the necessary voltage to pull the gate of the MOSFET above the source. The driver controls the gate voltage of the power switch.

Current Limit

The RT9741 continuously monitors the output current for over-current protection to protect the system power, the power switch, and the load from damage during output short circuit. When an overload or short circuit occurs, the current-sense circuitry sends a control signal to the driver. The driver reduces the gate voltage and drives the power MOSFET into its saturation region, which switches the output into a constant-current mode and holds the current constant until the thermal shutdown occurs or the fault is removed.

Under-Voltage Lockout

A voltage-sense circuit monitors the input voltage. When the input voltage is below approximately 1.3V, UVLO turns off the MOSFET switch.

Thermal Shutdown

The RT9741 continuously monitors the operating temperature of the power switch for over-temperature protection. The RT9741 turns off the power switch to prevent the device from damage if the junction temperature rises to approximately 120°C due to over-current or short-circuit conditions.

The pass element turns on again after the junction temperature cools to 80°C. The

RT9741 lowers its OTP trip level from 120°C to 100°C when output short circuit occurs ($V_{OUT} < 1V$).

Absolute Maximum Ratings (Note 1)

• Supply Input Voltage, V_{IN} -----	6V
• Power Dissipation, P_D @ $T_A = 25^\circ\text{C}$ SOT-23-3 -----	0.41W
• Package Thermal Resistance (Note 2) SOT-23-3, θ_{JA} -----	243.3°C/W
• Junction Temperature -----	150°C
• Lead Temperature (Soldering, 10 sec.) -----	260°C
• Storage Temperature Range -----	-65°C to 150°C
• ESD Susceptibility (Note 3) HBM (Human Body Model) -----	2kV

Recommended Operating Conditions (Note 4)

• Supply Input Voltage, V_{IN} -----	2.7V to 5.5V
• Junction Temperature Range -----	-40°C to 125°C
• Ambient Temperature Range -----	-40°C to 85°C

Electrical Characteristics

($V_{IN} = 5\text{V}$, $C_{IN} = 1\mu\text{F}$, $C_{OUT} = 10\mu\text{F}$, $T_A = 25^\circ\text{C}$, unless otherwise specified)

Parameter	Symbol	Test Conditions	Min	Typ	Max	Unit
Input Quiescent Current	I_Q	Switch On, $V_{OUT} = \text{Open}$	--	50	70	μA
Switch On-Resistance	RT9741A	$R_{DS(ON)}$ $V_{IN} = 5\text{V}$, $I_{OUT} = 1.3\text{A}$	--	100	120	$\text{m}\Omega$
	RT9741C		$V_{IN} = 5\text{V}$, $I_{OUT} = 0.6\text{A}$	--	120	
Current Limit	RT9741A	I_{LIM} $V_{OUT} = 4\text{V}$	1.5	2	--	A
	RT9741C		0.7	1	--	
Short Current	RT9741A	I_{SC_FB} $V_{OUT} = 0\text{V}$, Measured Prior to Thermal Shutdown	--	1.4	--	A
	RT9741C		--	0.7	--	
Output Turn-On Rising Time	T_{ON_RISE}	10% to 90% of V_{OUT} Rising	--	200	--	μs
Under-Voltage Lockout	V_{UVLO}	V_{IN} Rising	1.3	1.7	2.1	V
Under-Voltage Hysteresis	ΔV_{UVLO}	V_{IN} Decreasing	--	0.1	--	V
Thermal Shutdown Protection	T_{SD}	$V_{OUT} > 1\text{V}$	--	120	--	$^\circ\text{C}$
		$V_{OUT} = 0\text{V}$	--	100	--	
Thermal Shutdown Hysteresis	ΔT_{SD}	$V_{OUT} = 0\text{V}$	--	20	--	$^\circ\text{C}$

Note 1. Stresses beyond those listed "Absolute Maximum Ratings" may cause permanent damage to the device. These are stress ratings only, and functional operation of the device at these or any other conditions beyond those indicated in the operational sections of the specifications is not implied. Exposure to absolute maximum rating conditions may affect device reliability.

Note 2. θ_{JA} is measured at $T_A = 25^\circ\text{C}$ on a high effective thermal conductivity four-layer test board per JEDEC 51-7.

Note 3. Devices are ESD sensitive. Handling precaution is recommended.

Note 4. The device is not guaranteed to function outside its operating conditions.

RT9741

RICHTEK

Typical Application Circuit

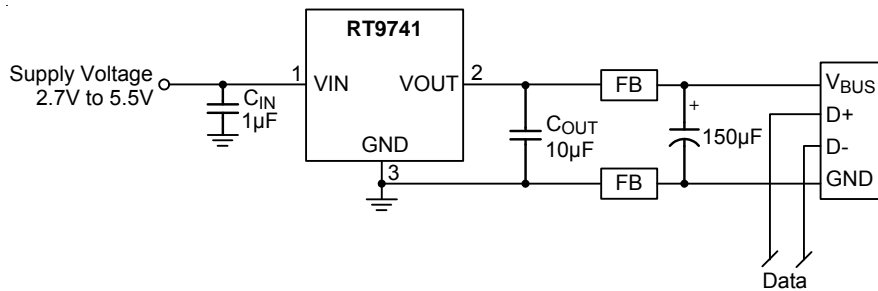

Note : A low-ESR 150µF aluminum electrolytic or tantalum capacitor between V_{OUT} and GND is strongly recommended to meet the 330mV maximum droop requirement in the hub V_{BUS}. (see Application Information Section for further details)

Typical Operating Characteristics

On Resistance vs. Input Voltage

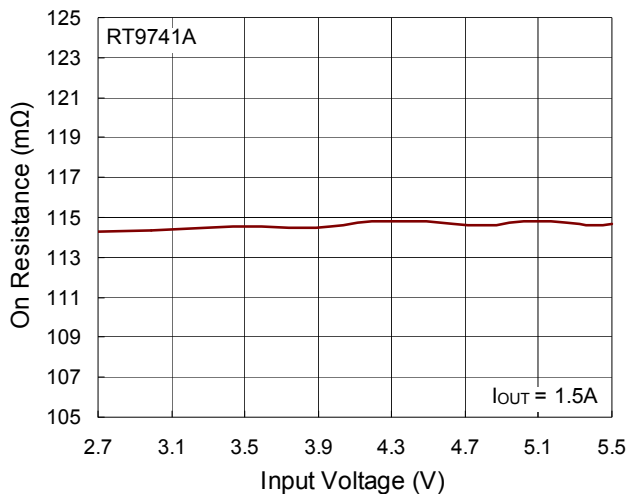

On Resistance vs. Temperature

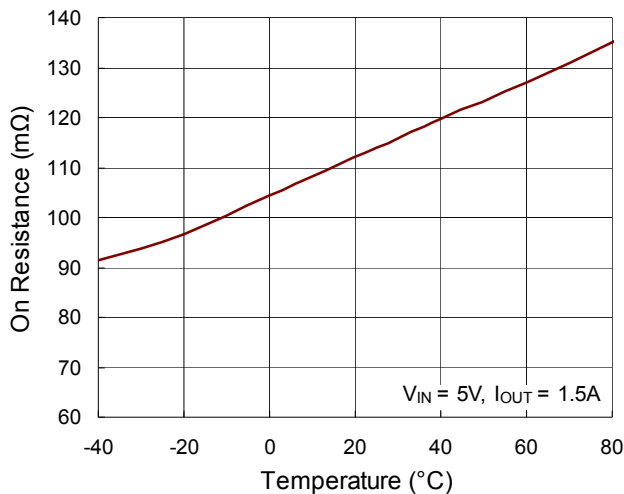

Quiescent Current vs. Input Voltage

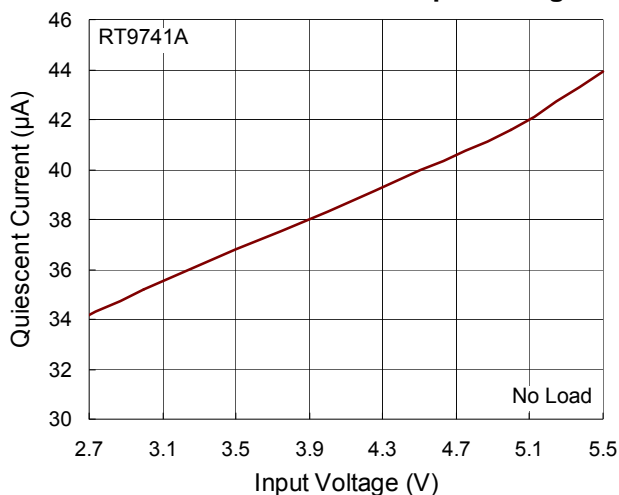

Quiescent Current vs. Temperature

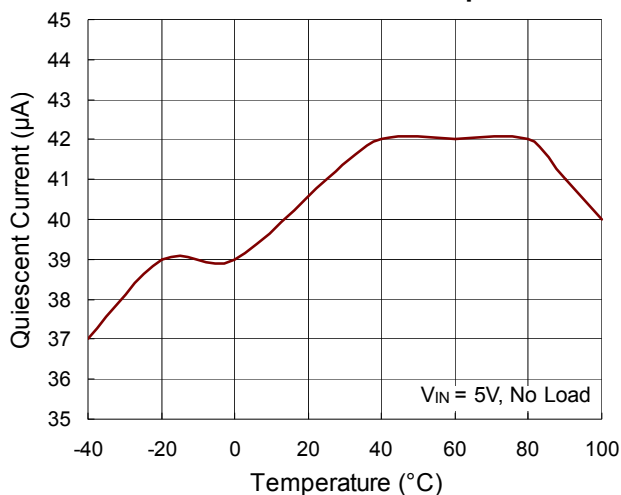

Output Voltage vs. Output Current

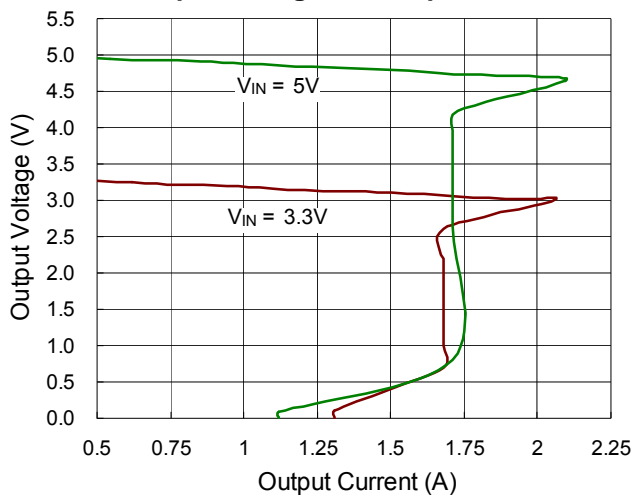

UVLO Threshold vs. Temperature

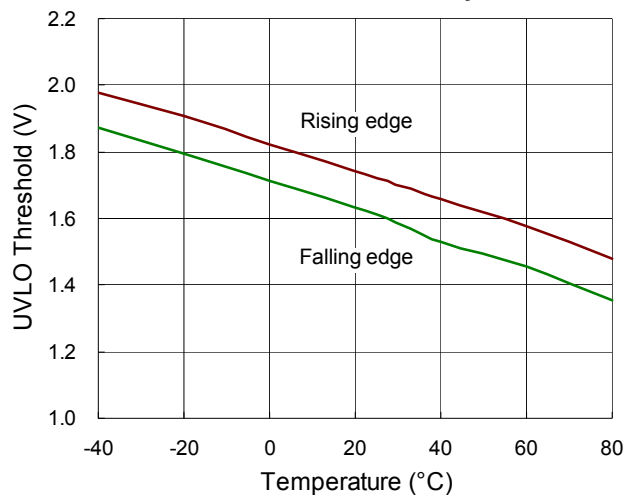

Current Limit vs. Input Voltage

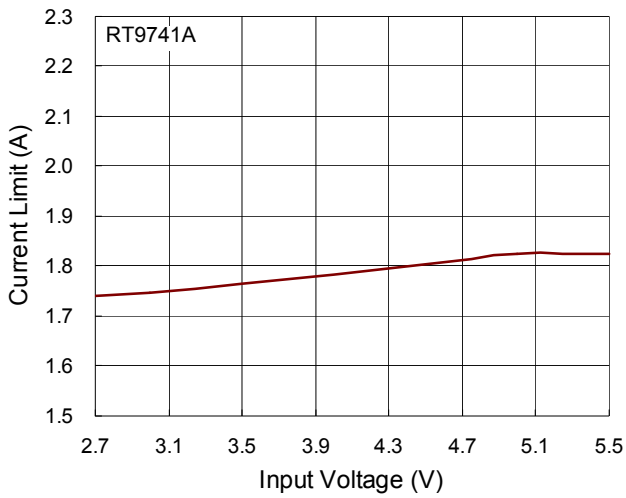

Current Limit vs. Temperature

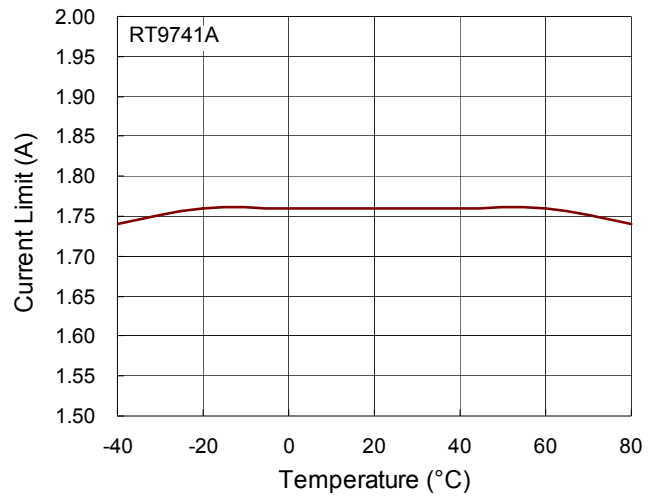

Short Current vs. Input Voltage

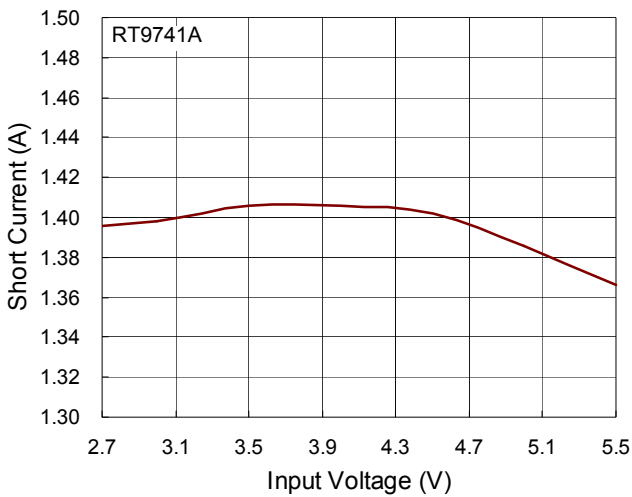

Short Current vs. Temperature

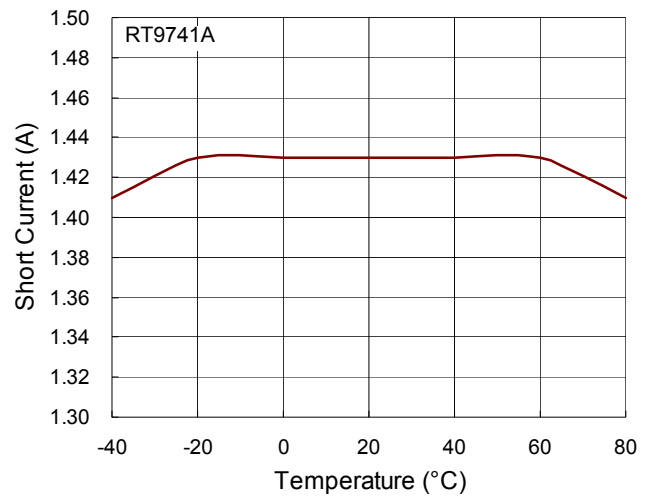

Power On from V_{IN}

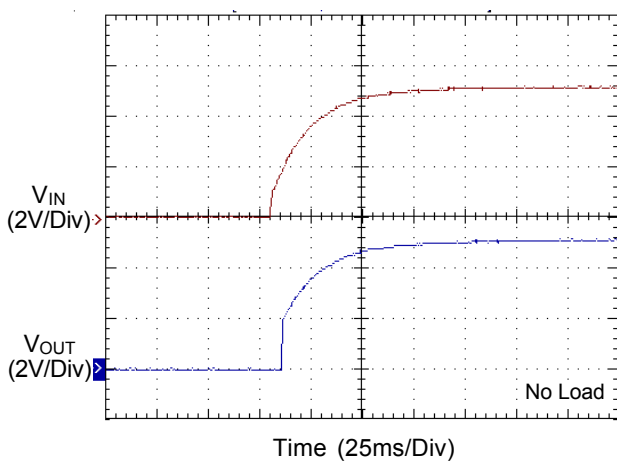

Power Off from V_{IN}

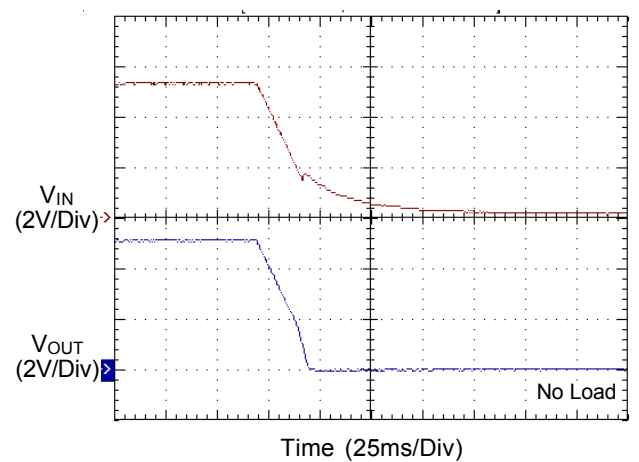

Application Information

The RT9741 is a single N-MOSFET high-side power switches, optimized for self-powered and bus-powered Universal Serial Bus (USB) applications. The RT9741 is equipped with a charge pump circuitry to drive the internal N-MOSFET switch; the switch's low $R_{DS(ON)}$ meets USB voltage drop requirements.

Input and Output

V_{IN} (input) is the power source connection to the internal circuitry and the drain of the MOSFET. V_{OUT} (output) is the source of the MOSFET. In a typical application, current flows through the switch from V_{IN} to V_{OUT} toward the load. If V_{OUT} is greater than V_{IN} , current will flow from V_{OUT} to V_{IN} since the MOSFET is bidirectional when on.

Soft-Start for Hot Plug-In Applications

In order to eliminate the upstream voltage droop caused by the large inrush current during hot-plug events, the "soft-start" feature effectively isolates the power source from extremely large capacitive loads, satisfying the USB voltage droop requirements.

Under-Voltage Lockout

Under-Voltage Lockout (UVLO) prevents the MOSFET switch from turning on until input the voltage exceeds approximately 1.7V. If input voltage drops below approximately 1.3V, UVLO turns off the MOSFET switch.

Current Limiting and Short-Circuit Protection

The current limit circuitry prevents damage to the MOSFET switch and the hub downstream port but can deliver load current up to the current limit threshold of typically 2A through the switch of the RT9741A and 1A for RT9741C respectively. When a heavy load or short circuit is applied to switch, a large transient current may flow until the current limit circuitry responds. Once this current limit threshold is exceeded, the device enters constant current mode until the thermal shutdown occurs or the fault is removed.

Thermal Shutdown

Thermal protection limits the power dissipation in RT9741. When the operation junction temperature exceeds 120°C, the OTP circuit starts the thermal shutdown function and turns the pass element off. The pass element turns on again after the junction temperature cools to 80°C. The RT9741 lowers its OTP trip level from 120°C to 100°C when output short circuit occurs ($V_{OUT} < 1V$) as shown in Figure 1.

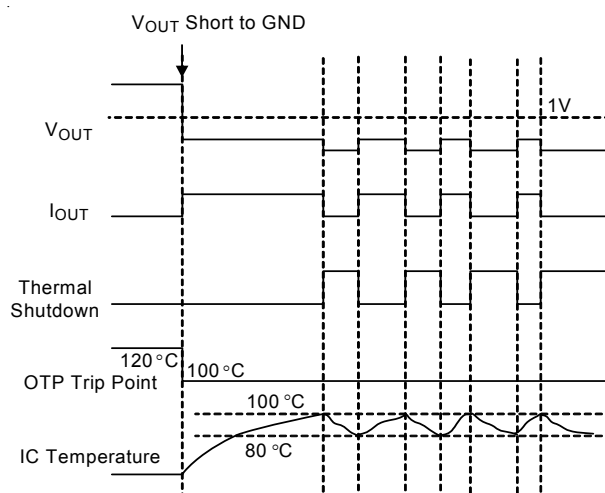

Figure 1. Short Circuit Thermal Folded Back Protection when Output Short Circuit Occurs (Patent)

Power Dissipation

The junction temperature of the RT9741 series depends on several factors such as the load, PCB layout, ambient temperature and package type. The output pin of the RT9741 can deliver the current of up to 2A (RT9741A) and 1A (RT9741C) respectively over the full operating junction temperature range. However, the maximum output current must be decreased at higher ambient temperature to ensure the junction temperature does not exceed 100°C. With all possible conditions, the junction temperature must be within the range specified under operating conditions. Power dissipation can be calculated based on the output current and the $R_{DS(ON)}$ of the switch as below.

$$P_D = R_{DS(ON)} \times I_{OUT}^2$$

Although the devices are rated for 2A and 1A of output current, but the application may limit the amount of output current based on the total power dissipation and the ambient temperature. The final operating junction temperature for any set of conditions can be estimated by the following thermal equation:

$$P_{D(MAX)} = (T_{J(MAX)} - T_A) / \theta_{JA}$$

Where $T_{J(MAX)}$ is the maximum junction temperature of the die (100°C) and T_A is the

maximum ambient temperature. The junction to ambient thermal resistance (θ_{JA}) for SOT-23-3 at recommended minimum footprint is 243.3°C/W (θ_{JA} is layout dependent).

Universal Serial Bus (USB) & Power Distribution

The goal of USB is to enable device from different vendors to interoperate in an open architecture. USB features include ease of use for the end user, a wide range of workloads and applications, robustness, synergy with the PC industry, and low-cost implementation. Benefits include self-identifying peripherals, dynamically attachable and reconfigurable peripherals, multiple connections (support for concurrent operation of many devices), support for as many as 127 physical devices, and compatibility with PC Plug-and-Play architecture.

The Universal Serial Bus connects USB devices with a USB host: each USB system has one USB host. USB devices are classified either as hubs, which provide additional attachment points to the USB, or as functions, which provide capabilities to the system (for example, a digital joystick). Hub devices are then classified as either Bus-Powered Hubs or Self-Powered Hubs.

A Bus-Powered Hub draws all of the power to any internal functions and downstream ports from the USB connector power pins. The hub may draw up to 500mA from the upstream device. External ports in a Bus-Powered Hub can supply up to 100mA per port, with a maximum of four external ports.

Self-Powered Hub power for the internal functions and downstream ports does not come from the USB, although the USB interface may draw up to 100mA from its upstream connect, to allow the interface to function when the remainder of the hub is powered down. The hub must

be able to supply up to 500mA on all of its external downstream ports. Please refer to Universal Serial Specification Revision 2.0 for more details on designing compliant USB hub and host systems.

Over-Current protection devices such as fuses and PTC resistors (also called poly-fuse or poly-switch) have slow trip times, high on-resistance, and lack the necessary circuitry for USB-required fault reporting.

The faster trip time of the RT9741 power distribution allows designers to design hubs that can operate through faults.

The RT9741 provides low on-resistance to meet voltage regulation and fault notification requirements.

Because the devices are also power switches, the designer of self-powered hubs has the flexibility to turn off power to output ports. Unlike a normal MOSFET, the devices have controlled rise and fall times to provide the needed inrush current limiting required for the bus-powered hub power switch.

Supply Filter/Bypass Capacitor

A 1 μ F low-ESR ceramic capacitor from V_{IN} to GND, located at the device is strongly recommended to prevent the input voltage drooping during hot-plug events. However, higher capacitor values will further reduce the voltage droop on the input. Furthermore, without the bypass capacitor, an output short may cause sufficient ringing on the input (from source lead inductance) to destroy the internal control circuitry. The input transient must not exceed 6V of the absolute maximum supply voltage even for a short duration.

Output Filter Capacitor

A low-ESR 150 μ F aluminum electrolytic or tantalum between V_{OUT} and GND is strongly recommended to meet the 330mV maximum droop requirement in the hub V_{BUS} (Per USB 2.0, output ports must have a minimum 120 μ F of low-ESR bulk capacitance per hub). Standard bypass methods should be used to minimize inductance and resistance between the bypass capacitor and the downstream connector to reduce EMI and decouple voltage droop caused when downstream cables are hot-insertion transients. Ferrite beads in series with V_{BUS} , the ground line and the 0.1 μ F bypass capacitors at the power

connector pins are recommended for EMI and ESD protection. The bypass capacitor itself should have a low dissipation factor to allow decoupling at higher frequencies.

Voltage Drop

The USB specification states a minimum port-output voltage in two locations on the bus, 4.75V out of a Self-Powered Hub port and 4.40V out of a Bus-Powered Hub port. As with the Self-Powered Hub, all resistive voltage drops for the Bus-Powered Hub must be accounted for to guarantee voltage regulation.

The following calculation determines $V_{OUT(MIN)}$ for multiple ports (N_{PORTS}) ganged together through one switch (if using one switch per port, N_{PORTS} is equal to 1) :

$$V_{OUT(MIN)} = 4.75V - [I_L \times (4 \times R_{CONN} + 2 \times R_{CABLE})] - (0.1A \times N_{PORTS} \times R_{SWITCH}) - V_{PCB}$$

Where

R_{CONN} = Resistance of connector contacts (two contacts per connector)

R_{CABLE} = Resistance of upstream cable wires (one 5V and one GND)

R_{SWITCH} = Resistance of power switch (typical 100m Ω for RT9741A and 120m Ω for RT9741C)

V_{PCB} = PCB voltage drop

The USB specification defines the maximum resistance per contact (R_{CONN}) of the USB connector to be 30m Ω and the drop across the PCB and switch to be 100mV. This basically leaves two variables in the equation: the resistance of the switch and the resistance of the cable. If the hub consumes the maximum current (I_L) of 500mA, the maximum resistance of the cable is 90m Ω . The resistance of the switch is defined as follows :

$$R_{SWITCH} = \{ 4.75V - 4.4V - [0.5A \times (4 \times 30m\Omega + 2 \times 90m\Omega)] - V_{PCB} \} \div (0.1A \times N_{PORTS}) \\ = (200mV - V_{PCB}) \div (0.1A \times N_{PORTS})$$

If the voltage drop across the PCB is limited to 100mV, the maximum resistance for the switch is 250m Ω for four ports ganged together. The RT9741, with its maximum 120m Ω on resistance can fit the demand of this requirement.

Thermal Considerations

For continuous operation, do not exceed absolute maximum junction temperature. The maximum power dissipation depends on the thermal resistance of the IC package, PCB layout, rate of surrounding airflow, and difference between junction and ambient temperature. The maximum power dissipation can be calculated by the following formula :

$$P_{D(MAX)} = (T_{J(MAX)} - T_A) / \theta_{JA}$$

where $T_{J(MAX)}$ is the maximum junction temperature, T_A is the ambient temperature, and θ_{JA} is the junction to ambient thermal resistance.

For recommended operating condition specifications, the maximum junction temperature is 125°C. The junction to ambient thermal resistance, θ_{JA} , is layout dependent. For SOT-23-3 package, the thermal resistance, θ_{JA} , is 243.3°C/W on a standard JEDEC 51-7 four-layer thermal test board. The maximum power dissipation at $T_A = 25^\circ\text{C}$ can be calculated by the following formula :

$$P_{D(MAX)} = (125^\circ\text{C} - 25^\circ\text{C}) / (243.3^\circ\text{C/W}) = 0.41\text{W for SOT-23-3 package}$$

The maximum power dissipation depends on the operating ambient temperature for fixed $T_{J(MAX)}$ and thermal resistance, θ_{JA} . The derating curve in Figure 2 allows the designer to see the effect of rising ambient temperature on the maximum power dissipation.

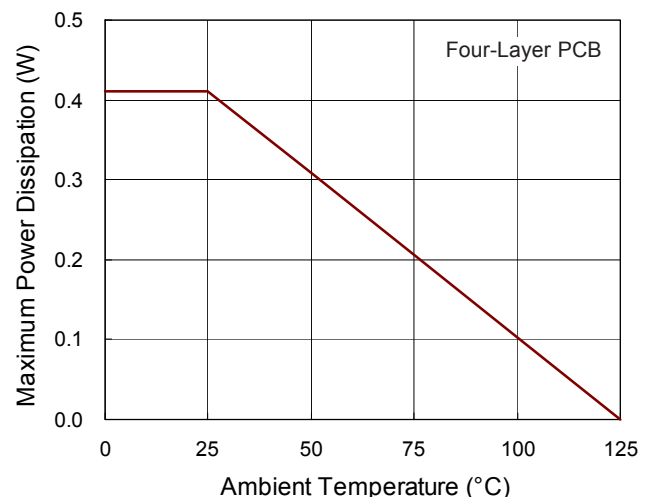

Figure 2. Derating Curve of Maximum Power Dissipation

RT9741



Layout Consideration

In order to meet the voltage drop, droop, and EMI requirements, careful PCB layout is necessary. The following guidelines must be followed :

- ▶ Locate the ceramic bypass capacitors as close as possible to the V_{IN} pins of the RT9741.
- ▶ Place a ground plane under all circuitry to lower both resistance and inductance and improve DC and transient performance (Use a separate ground and power plans if possible).
- ▶ Keep all V_{BUS} traces as short as possible and use at least 50-mil, 2 ounce copper for all V_{BUS} traces.
- ▶ Avoid via as much as possible. If via are necessary, make them as large as feasible.
- ▶ Place cuts in the ground plane between ports to help reduce the coupling of transients between ports.
- ▶ Locate the output capacitor and ferrite beads as close to the USB connectors as possible to lower impedance (mainly inductance) between the port and the capacitor and improve transient load performance.
- ▶ Locate the RT9741 as close as possible to the output port to limit switching noise.

The input capacitor should be placed as close as possible to the IC.

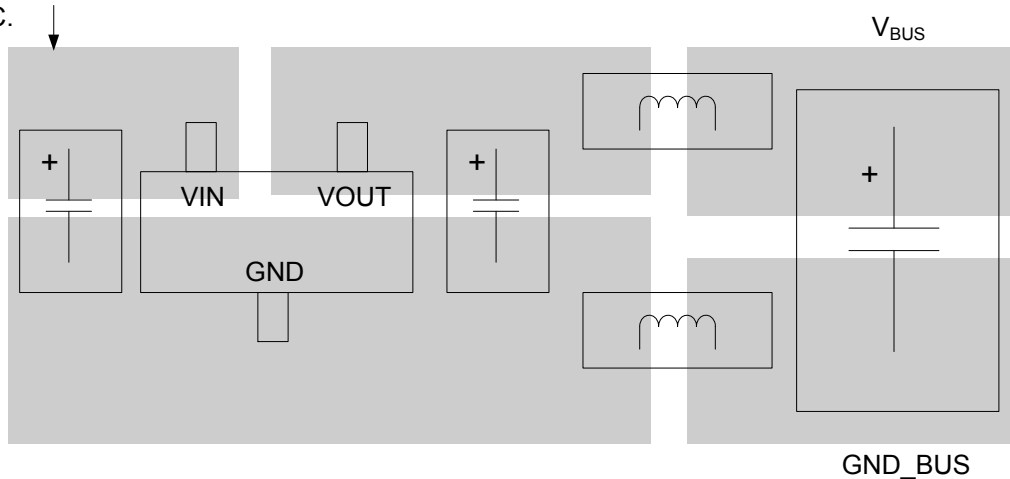
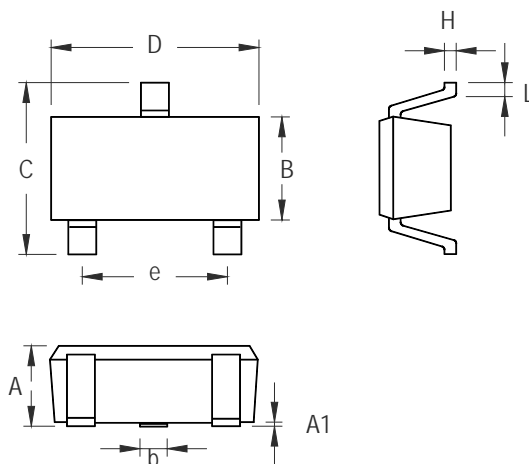

Figure 3. PCB Layout Guide

Outline Dimension



Symbol	Dimensions In Millimeters		Dimensions In Inches	
	Min	Max	Min	Max
A	0.889	1.295	0.035	0.051
A1	0.000	0.152	0.000	0.006
B	1.397	1.803	0.055	0.071
b	0.356	0.508	0.014	0.020
C	2.591	2.997	0.102	0.118
D	2.692	3.099	0.106	0.122
e	1.803	2.007	0.071	0.079
H	0.080	0.254	0.003	0.010
L	0.300	0.610	0.012	0.024

SOT-23-3 Surface Mount Package

Richtek Technology Corporation

14F, No. 8, Tai Yuen 1st Street, Chupei City

Hsinchu, Taiwan, R.O.C.

Tel: (8863)5526789

Richtek products are sold by description only. Richtek reserves the right to change the circuitry and/or specifications without notice at any time. Customers should obtain the latest relevant information and data sheets before placing orders and should verify that such information is current and complete. Richtek cannot assume responsibility for use of any circuitry other than circuitry entirely embodied in a Richtek product. Information furnished by Richtek is believed to be accurate and reliable. However, no responsibility is assumed by Richtek or its subsidiaries for its use; nor for any infringements of patents or other rights of third parties which may result from its use. No license is granted by implication or otherwise under any patent or patent rights of Richtek or its subsidiaries.

OUR CERTIFICATE

DiGi provide top-quality products and perfect service for customer worldwide through standardization, technological innovation and continuous improvement. DiGi through third-party certification, we stricly control the quality of products and services. Welcome your RFQ to

Email: Info@DiGi-Electronics.com



Tel: +00 852-30501935

RFQ Email: Info@DiGi-Electronics.com

DiGi is a global authorized distributor of electronic components.