

MCR03EZPFX5111 Datasheet

www.digi-electronics.com

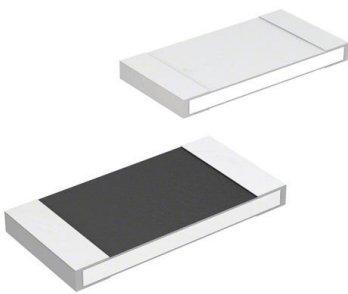

<https://www.DiGi-Electronics.com>

DiGi Electronics Part Number	MCR03EZPFX5111-DG
Manufacturer	Rohm Semiconductor
Manufacturer Product Number	MCR03EZPFX5111
Description	RES SMD 5.11K OHM 1% 1/10W 0603
Detailed Description	5.11 kOhms \pm 1% 0.1W, 1/10W Chip Resistor 0603 (1608 Metric) Automotive AEC-Q200 Thick Film

This model MCR03EZPFX5111 is available at DiGi Electronics.

DiGi Electronics offers a global database of semiconductor and electronic component datasheets.

We welcome your inquiries regarding pricing, lead time, or other product-related questions.

 [Request a Quote](#)

 [Datasheet Search](#)



Tel: +00 852-30501935

RFQ Email: Info@DiGi-Electronics.com

DiGi is a global authorized distributor of electronic components.

Purchase and inquiry

Manufacturer Product Number:

MCR03EZPFX5111

Series:

MCR

Resistance:

5.11 kOhms

Power (Watts):

0.1W, 1/10W

Features:

Automotive AEC-Q200

Operating Temperature:

-55°C ~ 155°C

Supplier Device Package:

0603

Size / Dimension:

0.063" L x 0.031" W (1.60mm x 0.80mm)

Number of Terminations:

2

Manufacturer:

Rohm Semiconductor

Product Status:

Discontinued at Digi-Key

Tolerance:

±1%

Composition:

Thick Film

Temperature Coefficient:

±100ppm/°C

Package / Case:

0603 (1608 Metric)

Ratings:

AEC-Q200

Height - Seated (Max):

0.022" (0.55mm)

Failure Rate:

-

Environmental & Export classification

RoHS Status:

ROHS3 Compliant

REACH Status:

REACH Unaffected

HTSUS:

8533.21.0030

Moisture Sensitivity Level (MSL):

1 (Unlimited)

ECCN:

EAR99



General purpose chip resistors

MCR series

Datasheet

●Features

- 1) Full line up from ultra small size 01005 to 2512 with jumper type.
- 2) High reliability metal glazed thick film.
- 3) ROHM resistors have obtained ISO9001/IATF16949 certification.
- 4) Corresponds to AEC-Q200 (Except MCR004)

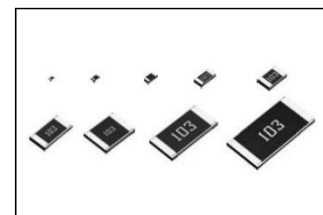

●Products list

Part No.	Type code	Rated power (70°C) (W)	Limiting element voltage (V)	Temperature coefficient (ppm/°C)	Resistance tolerance (%)	Resistance range (Ω)	Operating temperature range (°C)	Automotive Grade Available (AEC-Q200)
MCR004	QLP	0.031	15	±300	F(±1%)	10 ≤ R < 100 (E24/96 series)	-55 ~ +125	-
				±250		100 ≤ R ≤ 1M (E24/96 series)		
				+600/-100	J(±5%)	1 ≤ R < 10 (E24 series)		
				±300		10 ≤ R < 100 (E24 series)		
				±250	100 ≤ R ≤ 1M (E24 series)			
(Jumper type) Resistance : Max. 50mΩ, I _{max} : 0.5A								
MCR006	YLP	0.05	25	±200	D(±0.5%)	10 ≤ R < 1k (E24/96 series)	-55 ~ +125	Yes
				±100		1k ≤ R ≤ 1M (E24/96 series)		
				+600/-200	F(±1%)	1 ≤ R < 10 (E24 series)		
				±200		10 ≤ R ≤ 10M (E24/96 series)		
				+600/-200	J(±5%)	1 ≤ R < 10 (E24 series)		
±200	10 ≤ R ≤ 10M (E24 series)							
(Jumper type) Resistance : Max. 50mΩ, I _{max} : 0.5A								
ΔMCR01	M2P	0.063	50	±100	D(±0.5%)	10 ≤ R < 100 (E24/96 series)	-55 ~ +155	Yes
				±50		100 ≤ R ≤ 1M (E24/96 series)		
				±400	F(±1%)	1 ≤ R < 10 (E24 series)		
				±100		10 ≤ R ≤ 2.2M (E24/96 series)		
				+500/-250	J(±5%)	1 ≤ R < 10 (E24 series)		
±200	10 ≤ R ≤ 10M (E24 series)							
(Jumper type) Resistance : Max. 50mΩ, I _{max} : 1A								
ΔMCR03	EZP	0.1	50	±100	D(±0.5%)	10 ≤ R < 100 (E24/96 series)	-55 ~ +155	Yes
				±50		100 ≤ R ≤ 1M (E24/96 series)		
				±400	F(±1%)	1 ≤ R < 10 (E24 series)		
				±100		10 ≤ R ≤ 10M (E24/96 series)		
				±400	J(±5%)	1 ≤ R < 10 (E24 series)		
±200	10 ≤ R ≤ 10M (E24 series)							
(Jumper type) Resistance : Max. 50mΩ, I _{max} : 1A								
ΔMCR10	EZP	0.1	150	±100	D(±0.5%)	10 ≤ R < 100 (E24/96 series)	-55 ~ +155	Yes
		0.125		±50		100 ≤ R ≤ 1M (E24/96 series)		
				±100	F(±1%)	10 ≤ R ≤ 2.2M (E24/96 series)		
				±400		1 ≤ R < 10 (E24 series)		
				±200	J(±5%)	10 ≤ R ≤ 10M (E24 series)		
(Jumper type) Resistance : Max. 50mΩ, I _{max} : 2A								
ΔMCR18	EZP	0.125	200	±100	D(±0.5%)	10 ≤ R < 100 (E24/96 series)	-55 ~ +155	Yes
		0.25		±50		100 ≤ R ≤ 1M (E24/96 series)		
				±100	F(±1%)	10 ≤ R ≤ 2.2M (E24/96 series)		
				±400		1 ≤ R < 10 (E24 series)		
				±200	J(±5%)	10 ≤ R ≤ 10M (E24 series)		
(Jumper type) Resistance : Max. 50mΩ, I _{max} : 2A								
▲ MCR25	JZH	0.25 ~ 0.5 ^{*1}	200	±100	F(±1%)	10 ≤ R ≤ 1M (E24/96 series)	-55 ~ +155	Yes
				500±350		1 ≤ R < 2.2 (E24 series)		
				±500	J(±5%)	2.2 ≤ R < 5.6 (E24 series)		
				±200		5.6 ≤ R ≤ 3.3M (E24 series)		
				(Jumper type) Resistance : Max. 50mΩ, I _{max} : 2A				
▲ MCR50	JZH	0.5	200	±100	F(±1%)	10 ≤ R ≤ 180k (E24/96 series)	-55 ~ +155	Yes
				500±350		1 ≤ R < 2.2 (E24 series)		
				±500	J(±5%)	2.2 ≤ R < 10 (E24 series)		
				±200		10 ≤ R ≤ 330k (E24 series)		
				±350	330k < R ≤ 560k (E24 series)			
(Jumper type) Resistance : Max. 50mΩ, I _{max} : 3A								
▲ MCR100	JZH	1	200	±100	F(±1%)	10 ≤ R ≤ 82k (E24/96 series)	-55 ~ +125	Yes
				500±350		1 ≤ R < 2.2 (E24 series)		
				±500	J(±5%)	2.2 ≤ R < 10 (E24 series)		
				±350		10 ≤ R < 24 (E24 series)		
				±200	24 ≤ R ≤ 100k (E24 series)			
(Jumper type) Resistance : Max. 50mΩ, I _{max} : 4A								

Design and specifications are subject to change without notice. Carefully check the specification sheet supplied with the product before using or ordering it.

△ : For customers who are currently purchasing the products from ROHM or its authorized distributor.

Please consider MCRS series or recommended products for new adoption. (Please refer to [P.7](#))

For detailed product specifications, be sure to check the data sheet or specification. (Please contact us for details.)

▲ : NRND (Not Recommended for New Design)

Please consider MCRS series or recommended products for new adoption. (Please refer to [P.7](#))

For detailed product specifications, be sure to check the data sheet or specification. (Please contact us for details.)

Rated voltage is determined from the following.

When rated voltage exceeds the limiting element voltage, the limiting element voltage shall be the rated voltage.

Rated voltage = $\sqrt{\text{Rated power} \times \text{Nominal Resistance}}$

E24 : Standard products, E96 : Build to order

*1 Rated power 1Ω ≤ R < 10Ω : 0.25W, 10Ω ≤ R < 10kΩ : 0.5W, 10kΩ ≤ R ≤ 3.3MΩ : 0.33W

●Part number description

MCR**03****EZP****F****X****1000**

①

②

③

④

⑤

⑥

①

Part No.
MCR
General purpose chip resistors

②

Size	(mm)	[inch]
004	(0402)	[01005]
006	(0603)	[0201]
01	(1005)	[0402]
03	(1608)	[0603]
10	(2012)	[0805]
18	(3216)	[1206]
25	(3225)	[1210]
50	(5025)	[2010]
100	(6432)	[2512]

③

Packing specifications code			
Part No.	Code	Packing specifications	Quantity /Reel(pcs)
MCR004	QLP	Paper tape (2mm Pitch)	20,000
MCR006	YLP	Paper tape (2mm Pitch)	15,000
MCR01	MZP	Paper tape (2mm Pitch)	10,000
MCR03	EZP	Paper tape (4mm Pitch)	5,000
MCR10	EZP	Paper tape (4mm Pitch)	5,000
MCR18	EZP	Paper tape (4mm Pitch)	5,000
MCR25	JZH	Embossed tape (4mm Pitch)	4,000
MCR50	JZH	Embossed tape (4mm Pitch)	4,000
MCR100	JZH	Embossed tape (4mm Pitch)	4,000

④

Resistance tolerance
D(±0.5%)
F (±1%)
J (±5%) (Including jumper type)

⑤

Special part code
L(1Ω ≤ R < 10Ω)*2
X*3
*2 Only MCR006/01/03 F class
*3 Only MCR03 F class TCR ±100ppm/°C

⑥

Nominal resistance						
Resistance code, 3 or 4 digits.						
000 denotes jumper type.						
<table border="1"> <thead> <tr> <th>Resistance tolerance</th> <th>Resistance code</th> </tr> </thead> <tbody> <tr> <td>D, F</td> <td>: 4 digits</td> </tr> <tr> <td>J</td> <td>: 3 digits</td> </tr> </tbody> </table>	Resistance tolerance	Resistance code	D, F	: 4 digits	J	: 3 digits
Resistance tolerance	Resistance code					
D, F	: 4 digits					
J	: 3 digits					
EX)						
1Ω = 1R00 (±1%) 1R0 (±5%)						
9.1Ω = 9R10 (±1%) 9R1 (±5%)						
10Ω = 10R0 (±0.5%, ±1%) 100 (±5%)						
2.2MΩ = 2204 (±0.5%, ±1%) 225 (±5%)						

●Chip resistor dimensions and markings

■MCR004/006/01/03

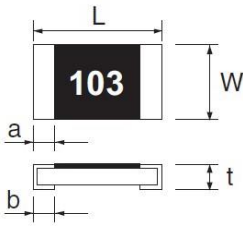

■MCR10/18/25/50/100

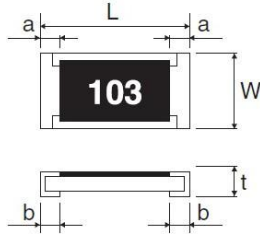

<Marking method>

There are three or four digits used for the calculation number code and R is used for the decimal point.

(Unit : mm)

Part No.	Type code	(mm)	(inch)	L	W	t	a	b	Marking existence
MCR004	QLP	0402	01005	0.40±0.02	0.20±0.02	0.13±0.02	0.10±0.03	0.10±0.03	No
MCR006	YLP	0603	0201	0.60±0.03	0.30±0.03	0.23±0.03	0.10±0.05	0.15±0.05	No
MCR01	MZP	1005	0402	1.00±0.05	0.50±0.05	0.35±0.05	0.20±0.10	0.25+0.05 -0.10	No
MCR03	EZP	1608	0603	1.60±0.10	0.80±0.10	0.45±0.10	0.30±0.20	0.30±0.20	Yes ^{*5}
MCR10	EZP	2012	0805	2.00±0.10	1.25±0.10	0.55±0.10	0.40±0.20	0.40±0.20	Yes
MCR18	EZP	3216	1206	3.20±0.15	1.60±0.15	0.55±0.10	0.50±0.25	0.50±0.25	Yes
MCR25	JZH	3225	1210	3.20±0.15	2.50±0.15	0.55±0.10	0.50±0.25	0.50±0.25	Yes ^{*4}
MCR50	JZH	5025	2010	5.00±0.15	2.50±0.15	0.55±0.15	0.60±0.25	0.60±0.25	Yes ^{*4}
MCR100	JZH	6432	2512	6.30±0.15	3.20±0.15	0.55±0.15	0.60±0.25	0.60±0.25	Yes ^{*4}

Marking method of jumper type

Jumper type	Marking existence
MCR004/006/01/25/50/100	No
MCR03/10/18	Yes

*4 : Marking method of MCR25/50/100

Blue glass over coat is used for the jumper type. There is no marking on the jumper type.

*5 : Marking method of MCR03

For MCR03 series resistors, the printing process restricts the marking to three digits/characters. Consequently, 1% tolerance resistors with values from the E24 series will be marked the same as 5% resistors with the same value, but 1% tolerance resistors with values from the E96 series will not be marked. However, regarding E96 series, the resistance values which overlaps with E24 series will be indicated by 3 digits.

Examples:

MCR03EZPJ243	J class (5% tolerance, E24 / 24 kΩ)	Marking = 243
MCR03EZPF2402	F class (1% tolerance, E24 / 24 kΩ)	Marking = 243
MCR03EZPF2432	F class (1% tolerance, E96 / 24.3 kΩ)	No Marking
MCR03EZPF2000	F class (1% tolerance, E24, E96 / 200Ω)	Marking = 201

MCR18EZPJ243	J class (5% tolerance, E24 / 24 kΩ)	Marking = 243
MCR18EZPF2402	F class (1% tolerance, E24 / 24 kΩ)	Marking = 2402
MCR18EZPF2432	F class (1% tolerance, E96 / 24.3 kΩ)	Marking = 2432

Land pattern example

(Unit : mm)

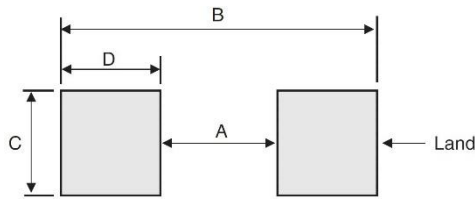

Dimensions Part No.	A	B	C	D
MCR004	0.12	0.48	0.22	0.18
MCR006	0.3	0.84	0.3	0.27
MCR01	0.5	1.3	0.5	0.4
MCR03	1.0	2.0	0.8	0.5
MCR10	1.2	2.6	1.15	0.7
MCR18	2.2	4.0	1.5	0.9
MCR25	2.2	4.0	2.3	0.9
MCR50	3.8	6.0	2.3	1.1
MCR100	5.1	8.1	3.0	1.5

Derating curve

When the ambient temperature exceeds 70°C, power dissipation must be adjusted according to the derating curve below.

■MCR004/006/100

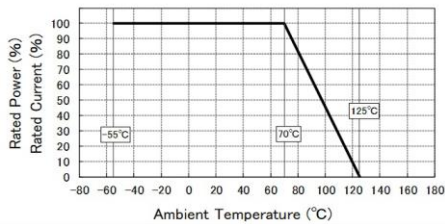

■MCR01/03/10/18/25/50

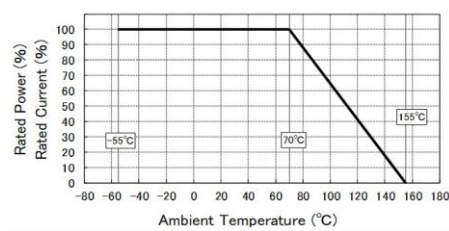

Characteristics

Test items	Guaranteed value		Test conditions
	Resistor type	Jumper type	
Resistance	See P.1		20°C
Variation of resistance with temperature	See P.1		Measurement : +25/-55, +25/+125°C (MCR004/006/25/50/100) : +25/+125°C (MCR01/03/10/18)
Overload	±(2.0%+0.1Ω)	MAX. 50mΩ	Test voltage is the smaller one of ① or ② ① Rated voltage(current)×2.5, 2s ② Maximum overload voltage ^{*6}
Solderability	A new uniform coating of minimum of 95% of the surface being immersed and no soldering damage.		Rosin-ethanol solution(25% mass) Soldering condition : 245±5°C Duration of immersion : 2.0±0.5s
Resistance to soldering heat	±(1.0%+0.05Ω) No remarkable abnormality on the appearance.	MAX. 50mΩ	Soldering condition : 260±5°C Duration of immersion : 10±1s
Rapid change of temperature	±(1.0%+0.05Ω)	MAX. 50mΩ	Test temp. -55°C~+125°C 1,000cycles (MCR006/01/03/10/18) -55°C~+125°C 100cycles (MCR004) -55°C~+125°C 5cycles (MCR25/50/100)
Temperature humidity storage	±(3.0%+0.1Ω)	MAX. 100mΩ	85°C, 85%(Relative humidity) (MCR006/01/03/10/18) 40°C, 93% (Relative humidity) (MCR004/25/50/100) Test time : 1,000h
Endurance at 70°C	±(3.0%+0.1Ω)	MAX. 100mΩ	Rated voltage(current), 70°C±3°C 1.5h:ON-0.5h:OFF Test time : 1,000h
Endurance	±(3.0%+0.1Ω)	MAX. 100mΩ	155°C (MCR01/03/10/18/25/50) 125°C (MCR004/006/100) Test time : 1,000h
Resistance to solvent	±(1.0%+0.05Ω)	MAX. 50mΩ	23±5°C, Immersion cleaning, 5±0.5min Solvent: 2-propanol
Bend strength of the end face plating	±(1.0%+0.05Ω) Without mechanical damage such as breaks.	MAX. 50mΩ	Endurance with 90mm width Deflection : 3mm (MCR004/006/01/03/10/18) Deflection : 1mm (MCR25/50/100)

Compliance Standards : IEC 60115-1 / IEC 60115-8
JIS C 5201-1 / JIS C 5201-8

*6 Maximum overload voltage

MCR004	MCR006	MCR01	MCR03	MCR10	MCR18	MCR25	MCR50	MCR100
30V	50V	100V	100V	300V	400V	400V	400V	400V

●Tape dimensions

(Unit : mm)

■Paper tape

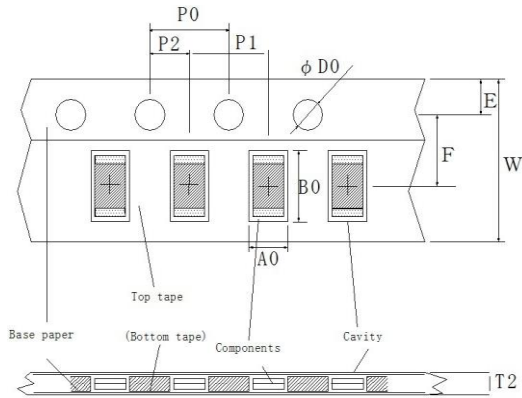

Part No.	Type code	W	F	E	A0	B0
MCR004	QLP	8.0±0.2	3.5±0.05	1.75±0.1	0.24±0.03	0.45±0.03
MCR006	YLP	8.0±0.2	3.5±0.05	1.75±0.1	0.38±0.03	0.68±0.03
MCR01	MZP	8.0±0.3	3.5±0.05	1.75±0.1	0.70±0.1	1.20±0.1
MCR03	EZP	8.0±0.3	3.5±0.05	1.75±0.1	1.10±0.1	1.90±0.1
MCR10	EZP	8.0±0.3	3.5±0.05	1.75±0.1	1.65+0.2 -0.1	2.40+0.2 -0.1
MCR18	EZP	8.0±0.3	3.5±0.05	1.75±0.1	1.95+0.1 -0.05	3.50+0.15 -0.05

Part No.	Type code	D0	P0	P1	P2	T2
MCR004	QLP	$\Phi 1.5+0.1$ 0	4.0±0.1	2.0±0.05	2.0±0.05	MAX0.5
MCR006	YLP	$\Phi 1.5+0.1$ 0	4.0±0.1	2.0±0.05	2.0±0.05	MAX0.5
MCR01	MZP	$\Phi 1.5+0.1$ 0	4.0±0.1	2.0±0.05	2.0±0.05	MAX1.1
MCR03	EZP	$\Phi 1.5+0.1$ 0	4.0±0.1	4.0±0.1	2.0±0.05	MAX1.1
MCR10	EZP	$\Phi 1.5+0.1$ 0	4.0±0.1	4.0±0.1	2.0±0.05	MAX1.1
MCR18	EZP	$\Phi 1.5+0.1$ 0	4.0±0.1	4.0±0.1	2.0±0.05	MAX1.1

■Embossed tape

(Unit : mm)

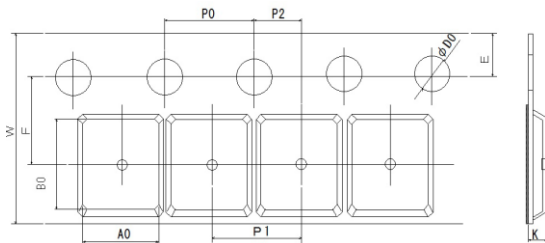

Part No.	Type code	W	F	E	A0	B0
MCR25	JZH	8.0±0.3	3.5±0.05	1.75±0.1	3.0±0.1	3.5±0.1
MCR50	JZH	12.0±0.3	5.5±0.05	1.75±0.1	3.4±0.2	5.6±0.2
MCR100	JZH	12.0±0.3	5.5±0.05	1.75±0.1	3.5±0.2	6.7±0.2

Part No.	Type code	D0	P0	P1	P2	K
MCR25	JZH	$\Phi 1.5+0.1$ 0	4.0±0.1	4.0±0.1	2.0±0.05	MAX1.1
MCR50	JZH	$\Phi 1.5+0.1$ 0	4.0±0.1	4.0±0.1	2.0±0.05	MAX1.1
MCR100	JZH	$\Phi 1.5+0.1$ 0	4.0±0.1	4.0±0.1	2.0±0.05	MAX1.1

MCR series

●Reel dimensions

Using two kinds of reels for taping.

① MCR004/006/01/03/10/18/25/50/100

② MCR004/006/01/03/10/18/25

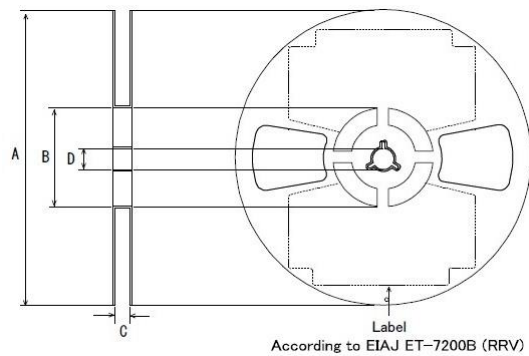
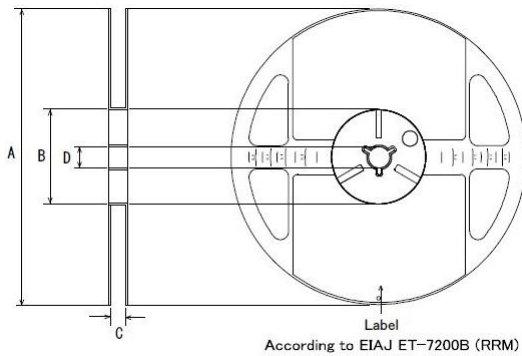



(Unit : mm)

Part No.	Type code	A	B	C	D
MCR004	QLP	Φ180 0 -1.5	Φ60 +1.0 0	9 +1.0 0	Φ13±0.2
MCR006	YLP				
MCR01	MZP				
MCR03	EZP				
MCR10	EZP				
MCR18	EZP				
MCR25	JZH			13 +1.0 0	
MCR50	JZH				
MCR100	JZH				

MCR series

●Recommended products

MCR series (Conventional products)						Recommended products											
General purpose chip resistors						General purpose chip resistors <High power>					Anti-surge chip resistors						
MCR series						MCRS series					ESR series						
																	
Part No.	Size		Rated power (W)	Rated ambient temperature (°C)	Rated terminal temperature (°C)	Part No.	Size		Rated power (W)	Rated ambient temperature (°C)	Rated terminal temperature (°C)	Part No.	Size		Rated power (W)	Rated ambient temperature (°C)	Rated terminal temperature (°C)
	(mm)	[inch]					(mm)	[inch]					(mm)	[inch]			
MCR01	(1005)	[0402]	0.063	70	-	MCR01S	(1005)	[0402]	0.1	70	-	ESR01	(1005)	[0402]	0.2	70	-
MCR03	(1608)	[0603]	0.1	70	-	MCR03S	(1608)	[0603]	0.125	70	-	ESR03	(1608)	[0603]	0.25	70	-
MCR10	(2012)	[0805]	0.125	70	-	MCR10S	(2012)	[0805]	0.25	70	-	ESR10	(2012)	[0805]	0.5 0.4 ^{*7}	70	115, 125
MCR18	(3216)	[1206]	0.25	70	-	MCR18S	(3216)	[1206]	0.4	70	-	ESR18	(3216)	[1206]	0.75, 0.5 ^{*7}	70	105, 125
MCR25	(3225)	[1210]	0.25~0.5 ^{*7}	70	-	-	-	-	-	-	-	ESR25	(3225)	[1210]	1	70	95
MCR50	(5025)	[2010]	0.5	70	-	MCR50S	(5025)	[2010]	1.5	70	105	-	-	-	-	-	-
MCR100	(6432)	[2512]	1	70	-	MCR100S	(6432)	[2512]	2	70	105	-	-	-	-	-	-

The above products are recommended products corresponding to the products with \triangle and \blacktriangle mark on P.1.
Replacement with products of the same size and downsizing can be considered.
Please confirm data sheet and specification about detail.

*7 : Rated power varies with resistance range. Please see table.1

Table 1. Rated power and resistance range

Part No.	Resistance range (Ω)	Rated power (W)	Rated ambient temperature (°C)	Rated terminal temperature (°C)
MCR25	$1 \leq R < 10$	0.25	70	-
	$10 \leq R < 10k$	0.5	70	-
	$10k \leq R \leq 3.3M$	0.33	70	-
ESR10	$1 \leq R < 1k$	0.5	70	115
	$1k \leq R \leq 10M$	0.4	70	125
ESR18	$1 \leq R < 1k$	0.75	70	105
	$1k \leq R \leq 10M$	0.5	70	125

Notice

Precaution on using ROHM Products

1. If you intend to use our Products in devices requiring extremely high reliability (such as medical equipment ^(Note 1), aircraft/spacecraft, nuclear power controllers, etc.) and whose malfunction or failure may cause loss of human life, bodily injury or serious damage to property ("Specific Applications"), please consult with the ROHM sales representative in advance. Unless otherwise agreed in writing by ROHM in advance, ROHM shall not be in any way responsible or liable for any damages, expenses or losses incurred by you or third parties arising from the use of any ROHM's Products for Specific Applications.

(Note1) Medical Equipment Classification of the Specific Applications

JAPAN	USA	EU	CHINA
CLASS III	CLASS III	CLASS II b	CLASS III
CLASS IV		CLASS III	

2. ROHM designs and manufactures its Products subject to strict quality control system. However, semiconductor products can fail or malfunction at a certain rate. Please be sure to implement, at your own responsibilities, adequate safety measures including but not limited to fail-safe design against the physical injury, damage to any property, which a failure or malfunction of our Products may cause. The following are examples of safety measures:
 - [a] Installation of protection circuits or other protective devices to improve system safety
 - [b] Installation of redundant circuits to reduce the impact of single or multiple circuit failure
3. Our Products are not designed under any special or extraordinary environments or conditions, as exemplified below. Accordingly, ROHM shall not be in any way responsible or liable for any damages, expenses or losses arising from the use of any ROHM's Products under any special or extraordinary environments or conditions. If you intend to use our Products under any special or extraordinary environments or conditions (as exemplified below), your independent verification and confirmation of product performance, reliability, etc. prior to use, must be necessary:
 - [a] Use of our Products in any types of liquid, including water, oils, chemicals, and organic solvents
 - [b] Use of our Products outdoors or in places where the Products are exposed to direct sunlight or dust
 - [c] Use of our Products in places where the Products are exposed to sea wind or corrosive gases, including Cl₂, H₂S, NH₃, SO₂, and NO₂
 - [d] Use of our Products in places where the Products are exposed to static electricity or electromagnetic waves
 - [e] Use of our Products in proximity to heat-producing components, plastic cords, or other flammable items
 - [f] Sealing or coating our Products with resin or other coating materials
 - [g] Use of our Products without cleaning residue of flux (Exclude cases where no-clean type fluxes is used. However, recommend sufficiently about the residue.); or Washing our Products by using water or water-soluble cleaning agents for cleaning residue after soldering
 - [h] Use of the Products in places subject to dew condensation
4. The Products are not subject to radiation-proof design.
5. Please verify and confirm characteristics of the final or mounted products in using the Products.
6. In particular, if a transient load (a large amount of load applied in a short period of time, such as pulse, is applied, confirmation of performance characteristics after on-board mounting is strongly recommended. Avoid applying power exceeding normal rated power; exceeding the power rating under steady-state loading condition may negatively affect product performance and reliability.
7. De-rate Power Dissipation depending on ambient temperature. When used in sealed area, confirm that it is the use in the range that does not exceed the maximum junction temperature.
8. Confirm that operation temperature is within the specified range described in the product specification.
9. ROHM shall not be in any way responsible or liable for failure induced under deviant condition from what is defined in this document.

Precaution for Mounting / Circuit board design

1. When a highly active halogenous (chlorine, bromine, etc.) flux is used, the residue of flux may negatively affect product performance and reliability.
2. In principle, the reflow soldering method must be used on a surface-mount products, the flow soldering method must be used on a through hole mount products. If the flow soldering method is preferred on a surface-mount products, please consult with the ROHM representative in advance.

For details, please refer to ROHM Mounting specification

Precautions Regarding Application Examples and External Circuits

1. If change is made to the constant of an external circuit, please allow a sufficient margin considering variations of the characteristics of the Products and external components, including transient characteristics, as well as static characteristics.
2. You agree that application notes, reference designs, and associated data and information contained in this document are presented only as guidance for Products use. Therefore, in case you use such information, you are solely responsible for it and you must exercise your own independent verification and judgment in the use of such information contained in this document. ROHM shall not be in any way responsible or liable for any damages, expenses or losses incurred by you or third parties arising from the use of such information.

Precaution for Electrostatic

This Product is electrostatic sensitive product, which may be damaged due to electrostatic discharge. Please take proper caution in your manufacturing process and storage so that voltage exceeding the Products maximum rating will not be applied to Products. Please take special care under dry condition (e.g. Grounding of human body / equipment / solder iron, isolation from charged objects, setting of Ionizer, friction prevention and temperature / humidity control).

Precaution for Storage / Transportation

1. Product performance and soldered connections may deteriorate if the Products are stored in the places where:
 - [a] the Products are exposed to sea winds or corrosive gases, including Cl₂, H₂S, NH₃, SO₂, and NO₂
 - [b] the temperature or humidity exceeds those recommended by ROHM
 - [c] the Products are exposed to direct sunshine or condensation
 - [d] the Products are exposed to high Electrostatic
2. Even under ROHM recommended storage condition, solderability of products out of recommended storage time period may be degraded. It is strongly recommended to confirm solderability before using Products of which storage time is exceeding the recommended storage time period.
3. Store / transport cartons in the correct direction, which is indicated on a carton with a symbol. Otherwise bent leads may occur due to excessive stress applied when dropping of a carton.
4. Use Products within the specified time after opening a humidity barrier bag. Baking is required before using Products of which storage time is exceeding the recommended storage time period.

Precaution for Product Label

A two-dimensional barcode printed on ROHM Products label is for ROHM's internal use only.

Precaution for Disposition

When disposing Products please dispose them properly using an authorized industry waste company.

Precaution for Foreign Exchange and Foreign Trade act

Since concerned goods might be fallen under listed items of export control prescribed by Foreign exchange and Foreign trade act, please consult with ROHM in case of export.

Precaution Regarding Intellectual Property Rights

1. All information and data including but not limited to application example contained in this document is for reference only. ROHM does not warrant that foregoing information or data will not infringe any intellectual property rights or any other rights of any third party regarding such information or data.
2. ROHM shall not have any obligations where the claims, actions or demands arising from the combination of the Products with other articles such as components, circuits, systems or external equipment (including software).
3. No license, expressly or implied, is granted hereby under any intellectual property rights or other rights of ROHM or any third parties with respect to the Products or the information contained in this document. Provided, however, that ROHM will not assert its intellectual property rights or other rights against you or your customers to the extent necessary to manufacture or sell products containing the Products, subject to the terms and conditions herein.

Other Precaution

1. This document may not be reprinted or reproduced, in whole or in part, without prior written consent of ROHM.
2. The Products may not be disassembled, converted, modified, reproduced or otherwise changed without prior written consent of ROHM.
3. In no event shall you use in any way whatsoever the Products and the related technical information contained in the Products or this document for any military purposes, including but not limited to, the development of mass-destruction weapons.
4. The proper names of companies or products described in this document are trademarks or registered trademarks of ROHM, its affiliated companies or third parties.

General Precaution

1. Before you use our Products, you are requested to carefully read this document and fully understand its contents. ROHM shall not be in any way responsible or liable for failure, malfunction or accident arising from the use of any ROHM's Products against warning, caution or note contained in this document.
2. All information contained in this document is current as of the issuing date and subject to change without any prior notice. Before purchasing or using ROHM's Products, please confirm the latest information with a ROHM sales representative.
3. The information contained in this document is provided on an "as is" basis and ROHM does not warrant that all information contained in this document is accurate and/or error-free. ROHM shall not be in any way responsible or liable for any damages, expenses or losses incurred by you or third parties resulting from inaccuracy or errors of or concerning such information.

OUR CERTIFICATE

DiGi provide top-quality products and perfect service for customer worldwide through standardization, technological innovation and continuous improvement. DiGi through third-party certification, we stricly control the quality of products and services. Welcome your RFQ to

Email: Info@DiGi-Electronics.com



Tel: +00 852-30501935

RFQ Email: Info@DiGi-Electronics.com

DiGi is a global authorized distributor of electronic components.