

M2S090-1FGG484 Datasheet

www.digi-electronics.com



M2S090-1FGG484

<https://www.DiGi-Electronics.com>

DiGi Electronics Part Number	M2S090-1FGG484-DG
Manufacturer	Microchip Technology
Manufacturer Product Number	M2S090-1FGG484
Description	IC SOC CORTEX-M3 166MHZ 484FBGA
Detailed Description	ARM® Cortex®-M3 System On Chip (SOC) IC SmartFusion®2 FPGA - 90K Logic Modules 166MHz 484-FPBGA (23x23)



Tel: +00 852-30501935

RFQ Email: Info@DiGi-Electronics.com

DiGi is a global authorized distributor of electronic components.

Purchase and inquiry

Manufacturer Product Number:

M2S090-1FGG484

Series:

SmartFusion®2

Architecture:

MCU, FPGA

Flash Size:

512KB

Peripherals:

DDR, PCIe, SERDES

Speed:

166MHz

Operating Temperature:

0°C ~ 85°C (TJ)

Supplier Device Package:

484-FPBGA (23x23)

Base Product Number:

M2S090

Manufacturer:

Microchip Technology

Product Status:

Active

Core Processor:

ARM® Cortex®-M3

RAM Size:

64KB

Connectivity:

CANbus, Ethernet, I2C, SPI, UART/USART, USB

Primary Attributes:

FPGA - 90K Logic Modules

Package / Case:

484-BGA

Number of I/O:

267

Environmental & Export classification

RoHS Status:

ROHS3 Compliant

REACH Status:

REACH Unaffected

HTSUS:

8542.39.0001

Moisture Sensitivity Level (MSL):

3 (168 Hours)

ECCN:

3A991D

DS0128
Datasheet
IGLOO2 FPGA and SmartFusion2 SoC FPGA



Microsemi Corporate Headquarters
One Enterprise, Aliso Viejo,
CA 92656 USA
Within the USA: +1 (800) 713-4113
Outside the USA: +1 (949) 380-6100
Fax: +1 (949) 215-4996
Email: sales.support@microsemi.com
www.microsemi.com

© 2016 Microsemi Corporation. All rights reserved. Microsemi and the Microsemi logo are trademarks of Microsemi Corporation. All other trademarks and service marks are the property of their respective owners.

Microsemi makes no warranty, representation, or guarantee regarding the information contained herein or the suitability of its products and services for any particular purpose, nor does Microsemi assume any liability whatsoever arising out of the application or use of any product or circuit. The products sold hereunder and any other products sold by Microsemi have been subject to limited testing and should not be used in conjunction with mission-critical equipment or applications. Any performance specifications are believed to be reliable but are not verified, and Buyer must conduct and complete all performance and other testing of the products, alone and together with, or installed in, any end-products. Buyer shall not rely on any data and performance specifications or parameters provided by Microsemi. It is the Buyer's responsibility to independently determine suitability of any products and to test and verify the same. The information provided by Microsemi hereunder is provided "as is, where is" and with all faults, and the entire risk associated with such information is entirely with the Buyer. Microsemi does not grant, explicitly or implicitly, to any party any patent rights, licenses, or any other IP rights, whether with regard to such information itself or anything described by such information. Information provided in this document is proprietary to Microsemi, and Microsemi reserves the right to make any changes to the information in this document or to any products and services at any time without notice.

About Microsemi

Microsemi Corporation (Nasdaq: MSCC) offers a comprehensive portfolio of semiconductor and system solutions for aerospace & defense, communications, data center and industrial markets. Products include high-performance and radiation-hardened analog mixed-signal integrated circuits, FPGAs, SoCs and ASICs; power management products; timing and synchronization devices and precise time solutions, setting the world's standard for time; voice processing devices; RF solutions; discrete components; enterprise storage and communication solutions, security technologies and scalable anti-tamper products; Ethernet solutions; Power-over-Ethernet ICs and midspans; as well as custom design capabilities and services. Microsemi is headquartered in Aliso Viejo, California, and has approximately 4,800 employees globally. Learn more at www.microsemi.com.

Contents

1	Revision History	1
1.1	Revision 11.0	1
1.2	Revision 10.0	1
1.3	Revision 9.0	1
1.4	Revision 8.0	2
1.5	Revision 7.0	2
1.6	Revision 6.0	2
1.7	Revision 5.0	2
1.8	Revision 4.0	2
1.9	Revision 3.0	3
1.10	Revision 2.0	3
1.11	Revision 1.0	3
2	IGLOO2 FPGA and SmartFusion2 SoC FPGA	4
2.1	Device Status	4
2.2	References	5
2.3	Electrical Specifications	5
2.3.1	Operating Conditions	5
2.3.2	Power Consumption	12
2.3.3	Average Fabric Temperature and Voltage Derating Factors	14
2.3.4	Timing Model	15
2.3.5	User I/O Characteristics	17
2.3.6	Logic Element Specifications	75
2.3.7	Global Resource Characteristics	78
2.3.8	FPGA Fabric SRAM	79
2.3.9	Programming Times	94
2.3.10	Math Block Timing Characteristics	103
2.3.11	Embedded NVM (eNVM) Characteristics	104
2.3.12	SRAM PUF	105
2.3.13	Non-Deterministic Random Bit Generator (NRBG) Characteristics	106
2.3.14	Cryptographic Block Characteristics	106
2.3.15	Crystal Oscillator	107
2.3.16	On-Chip Oscillator	109
2.3.17	Clock Conditioning Circuits (CCC)	110
2.3.18	JTAG	112
2.3.19	System Controller SPI Characteristics	113
2.3.20	Power-up to Functional Times	114
2.3.21	DEVRST_N Characteristics	116
2.3.22	DEVRST_N to Functional Times	116
2.3.23	Flash*Freeze Timing Characteristics	119
2.3.24	DDR Memory Interface Characteristics	120
2.3.25	SFP Transceiver Characteristics	120
2.3.26	SerDes Electrical and Timing AC and DC Characteristics	121
2.3.27	SmartFusion2 Specifications	123
2.3.28	CAN Controller Characteristics	128
2.3.29	USB Characteristics	128
2.3.30	MMUART Characteristics	129
2.3.31	IGLOO2 Specifications	129

Figures

Figure 1	High Temperature Data Retention (HTR)	9
Figure 2	Timing Model	15
Figure 3	Input Buffer AC Loading	17
Figure 4	Output Buffer AC Loading	18
Figure 5	Tristate Buffer for Enable Path Test Point	19
Figure 6	Timing Model for Input Register	65
Figure 7	I/O Register Input Timing Diagram	66
Figure 8	Timing Model for Output/Enable Register	68
Figure 9	I/O Register Output Timing Diagram	69
Figure 10	Input DDR Module	70
Figure 11	Input DDR Timing Diagram	71
Figure 12	Output DDR Module	73
Figure 13	Output DDR Timing Diagram	74
Figure 14	LUT-4	75
Figure 15	Sequential Module	76
Figure 16	Sequential Module Timing Diagram	77
Figure 17	Power-up to Functional Timing Diagram for SmartFusion2	115
Figure 18	Power-up to Functional Timing Diagram for IGLOO2	116
Figure 19	DEVRST_N to Functional Timing Diagram for SmartFusion2	117
Figure 20	DEVRST_N to Functional Timing Diagram for IGLOO2	119
Figure 21	I2C Timing Parameter Definition	125
Figure 22	SPI Timing for a Single Frame Transfer in Motorola Mode (SPH = 1)	128
Figure 23	SPI Timing for a Single Frame Transfer in Motorola Mode (SPH = 1)	131

Tables

Table 1	IGLOO2 and SmartFusion2 Design Security Densities	4
Table 2	IGLOO2 and SmartFusion2 Data Security Densities	4
Table 3	Absolute Maximum Ratings	5
Table 4	Recommended Operating Conditions	6
Table 5	FPGA Operating Limits	7
Table 6	Embedded Operating Flash Limits	8
Table 7	Device Storage Temperature and Retention	8
Table 8	High Temperature Data Retention (HTR) Lifetime	8
Table 9	Package Thermal Resistance of SmartFusion2 and IGLOO2 Devices	10
Table 10	Quiescent Supply Current Characteristics	12
Table 11	SmartFusion2 and IGLOO2 Quiescent Supply Current ($V_{DD} = 1.2\text{ V}$) – Typical Process	12
Table 12	Currents During Program Cycle, $0\text{ }^{\circ}\text{C} \leq T_J \leq 85\text{ }^{\circ}\text{C}$ – Typical Process	13
Table 13	Currents During Verify Cycle, $0\text{ }^{\circ}\text{C} \leq T_J \leq 85\text{ }^{\circ}\text{C}$ – Typical Process	13
Table 14	SmartFusion2 and IGLOO2 Quiescent Supply Current ($V_{DD} = 1.26\text{ V}$) – Worst-Case Process	13
Table 15	Average Junction Temperature and Voltage Derating Factors for Fabric Timing Delays	14
Table 16	Inrush Currents at Power up, $-40\text{ }^{\circ}\text{C} \leq T_J \leq 100\text{ }^{\circ}\text{C}$ – Typical Process	14
Table 17	Timing Model Parameters	15
Table 18	Maximum Data Rate Summary Table for Single-Ended I/O in Worst-Case Industrial Conditions	19
Table 19	Maximum Data Rate Summary Table for Voltage-Referenced I/O in Worst-Case Industrial Conditions	20
Table 20	Maximum Data Rate Summary Table for Differential I/O in Worst-Case Industrial Conditions	20
Table 21	Maximum Frequency Summary Table for Single-Ended I/O in Worst-Case Industrial Conditions	20
Table 22	Maximum Frequency Summary Table for Voltage-Referenced I/O in Worst-Case Industrial Conditions	21
Table 23	Maximum Frequency Summary Table for Differential I/O in Worst-Case Industrial Conditions	21
Table 24	Input Capacitance, Leakage Current, and Ramp Time	22
Table 25	I/O Weak Pull-up/Pull-down Resistances for DDRIO I/O Bank	22
Table 26	I/O Weak Pull-up/Pull-down Resistances for MSIO I/O Bank	23
Table 27	I/O Weak Pull-up/Pull-down Resistances for MSIOD I/O Bank	23
Table 28	Schmitt Trigger Input Hysteresis	23
Table 29	LVTTTL/LVCMOS 3.3 V DC Recommended DC Operating Conditions (Applicable to MSIO I/O Bank Only)	24
Table 30	LVTTTL/LVCMOS 3.3 V Input Voltage Specification (Applicable to MSIO I/O Bank Only)	24
Table 31	LVCMOS 3.3 V DC Output Voltage Specification (Applicable to MSIO I/O Bank Only)	24
Table 32	LVTTTL 3.3 V DC Output Voltage Specification (Applicable to MSIO I/O Bank Only)	24
Table 33	LVTTTL/LVCMOS 3.3 V AC Maximum Switching Speed (Applicable to MSIO I/O Bank Only)	24
Table 34	LVTTTL/LVCMOS 3.3 V Receiver Characteristics for MSIO I/O Bank (Input Buffers)	25
Table 35	LVTTTL/LVCMOS 3.3 V Transmitter Characteristics for MSIO I/O Bank (Output and Tristate Buffers)	25
Table 36	LVTTTL/LVCMOS 3.3 V AC Test Parameter Specifications (Applicable to MSIO I/O Bank Only)	25
Table 37	LVTTTL/LVCMOS 3.3 V Transmitter Drive Strength Specifications for MSIO I/O Bank	25
Table 38	LVCMOS 2.5 V DC Recommended DC Operating Conditions	26
Table 39	LVCMOS 2.5 V DC Input Voltage Specification	26
Table 40	LVCMOS 2.5 V DC Output Voltage Specification	26
Table 41	LVCMOS 2.5 V AC Minimum and Maximum Switching Speed	26
Table 42	LVCMOS 2.5 V AC Calibrated Impedance Option	26
Table 43	LVCMOS 2.5 V Receiver Characteristics (Input Buffers)	27
Table 44	LVCMOS 2.5 V Transmitter Characteristics for DDRIO Bank (Output and Tristate Buffers)	27
Table 45	LVCMOS 2.5 V AC Test Parameter Specifications	27
Table 46	LVCMOS 2.5 V Transmitter Drive Strength Specifications	27
Table 47	LVCMOS 2.5 V Transmitter Characteristics for MSIO Bank (Output and Tristate Buffers)	28
Table 48	LVCMOS 1.8 V DC Recommended Operating Conditions	29
Table 49	LVCMOS 1.8 V DC Input Voltage Specification	29
Table 50	LVCMOS 1.8 V DC Output Voltage Specification	29

Table 51	LVC MOS 1.8 V Minimum and Maximum AC Switching Speed	29
Table 52	LVC MOS 2.5 V Transmitter Characteristics for MSIOD Bank (Output and Tristate Buffers)	29
Table 53	LVC MOS 1.8 V Receiver Characteristics (Input Buffers)	30
Table 54	LVC MOS 1.8 V AC Calibrated Impedance Option	30
Table 55	LVC MOS 1.8 V AC Test Parameter Specifications	30
Table 56	LVC MOS 1.8 V Transmitter Drive Strength Specifications	30
Table 57	LVC MOS 1.8 V Transmitter Characteristics for DDRIO I/O Bank with Fixed Code (Output and Tristate Buffers)	31
Table 58	LVC MOS 1.5 V DC Recommended Operating Conditions	32
Table 59	LVC MOS 1.5 V DC Input Voltage Specification	32
Table 60	LVC MOS 1.8 V Transmitter Characteristics for MSIO I/O Bank	32
Table 61	LVC MOS 1.8 V Transmitter Characteristics for MSIOD I/O Bank	32
Table 62	LVC MOS 1.5 V DC Output Voltage Specification	33
Table 63	LVC MOS 1.5 V AC Minimum and Maximum Switching Speed	33
Table 64	LVC MOS 1.5 V AC Calibrated Impedance Option	33
Table 65	LVC MOS 1.5 V AC Test Parameter Specifications	33
Table 66	LVC MOS 1.5 V Transmitter Drive Strength Specifications	33
Table 67	LVC MOS 1.5 V Receiver Characteristics for DDRIO I/O Bank with Fixed Codes (Input Buffers)	34
Table 68	LVC MOS 1.5 V Receiver Characteristics for MSIO I/O Bank (Input Buffers)	34
Table 69	LVC MOS 1.5 V Receiver Characteristics for MSIOD I/O Bank (Input Buffers)	34
Table 70	LVC MOS 1.5 V Transmitter Characteristics for DDRIO I/O Bank (Output and Tristate Buffers)	34
Table 71	LVC MOS 1.5 V Transmitter Characteristics for MSIO I/O Bank (Output and Tristate Buffers)	35
Table 72	LVC MOS 1.2 V DC Recommended DC Operating Conditions	36
Table 73	LVC MOS 1.2 V DC Input Voltage Specification	36
Table 74	LVC MOS 1.2 V DC Output Voltage Specification	36
Table 75	LVC MOS 1.2 V Minimum and Maximum AC Switching Speed	36
Table 76	LVC MOS 1.5 V Transmitter Characteristics for MSIOD I/O Bank (Output and Tristate Buffers)	36
Table 77	LVC MOS 1.2 V Receiver Characteristics for DDRIO I/O Bank with Fixed Code (Input Buffers)	37
Table 78	LVC MOS 1.2 V Receiver Characteristics for MSIO I/O Bank (Input Buffers)	37
Table 79	LVC MOS 1.2 V AC Calibrated Impedance Option	37
Table 80	LVC MOS 1.2 V AC Test Parameter Specifications	37
Table 81	LVC MOS 1.2 V Transmitter Drive Strength Specifications	37
Table 82	LVC MOS 1.2 V Receiver Characteristics for MSIOD I/O Bank (Input Buffers)	38
Table 83	LVC MOS 1.2 V Transmitter Characteristics for DDRIO I/O Bank (Output and Tristate Buffers)	38
Table 84	LVC MOS 1.2 V Transmitter Characteristics for MSIO I/O Bank (Output and Tristate Buffers)	38
Table 85	PCI/PCI-X DC Recommended Operating Conditions	39
Table 86	PCI/PCI-X DC Input Voltage Specification	39
Table 87	PCI/PCI-X DC Output Voltage Specification	39
Table 88	PCI/PCI-X Minimum and Maximum AC Switching Speed	39
Table 89	PCI/PCI-X AC Test Parameter Specifications	39
Table 90	LVC MOS 1.2 V Transmitter Characteristics for MSIOD I/O Bank (Output and Tristate Buffers)	39
Table 91	PCI/PCIX AC Switching Characteristics for Receiver for MSIO I/O Bank (Input Buffers)	40
Table 92	PCI/PCIX AC Switching Characteristics for Transmitter for MSIO I/O Bank (Output and Tristate Buffers)	40
Table 93	HSTL Recommended DC Operating Conditions	40
Table 94	HSTL DC Input Voltage Specification	40
Table 95	HSTL DC Output Voltage Specification Applicable to DDRIO I/O Bank Only	41
Table 96	HSTL DC Differential Voltage Specification	41
Table 97	HSTL AC Differential Voltage Specifications	41
Table 98	HSTL Minimum and Maximum AC Switching Speed	41
Table 99	HSTL Impedance Specification	41
Table 100	HSTL Receiver Characteristics for DDRIO I/O Bank with Fixed Code (Input Buffers)	42
Table 101	HSTL Transmitter Characteristics for DDRIO I/O Bank (Output and Tristate Buffers)	42
Table 102	HSTL AC Test Parameter Specification	42
Table 103	DDR1/SSTL2 DC Recommended Operating Conditions	43
Table 104	DDR1/SSTL2 DC Input Voltage Specification	43
Table 105	DDR1/SSTL2 DC Output Voltage Specification	43
Table 106	DDR1/SSTL2 DC Differential Voltage Specification	43
Table 107	SSTL2 Receiver Characteristics for DDRIO I/O Bank (Input Buffers)	44

Table 108	SSTL2 AC Differential Voltage Specifications	44
Table 109	SSTL2 Minimum and Maximum AC Switching Speeds	44
Table 110	SSTL2 AC Impedance Specifications	44
Table 111	DDR1/SSTL2 AC Test Parameter Specifications	44
Table 112	SSTL2 Receiver Characteristics for MSIO I/O Bank (Input Buffers)	45
Table 113	DDR1/SSTL2 Receiver Characteristics for MSIOD I/O Bank (Input Buffers)	45
Table 114	SSTL2 Class I Transmitter Characteristics for DDRIO I/O Bank (Output and Tristate Buffers)	45
Table 115	DDR1/SSTL2 Class I Transmitter Characteristics for MSIO I/O Bank (Output and Tristate Buffers)	45
Table 116	DDR1/SSTL2 Class I Transmitter Characteristics for MSIOD I/O Bank (Output and Tristate Buffers)	45
Table 117	DDR1/SSTL2 Class II Transmitter Characteristics for DDRIO I/O Bank (Output and Tristate Buffers)	45
Table 118	SSTL18 DC Recommended DC Operating Conditions	46
Table 119	SSTL18 DC Input Voltage Specification	46
Table 120	SSTL18 DC Output Voltage Specification	46
Table 121	DDR1/SSTL2 Class II Transmitter Characteristics for MSIO I/O Bank (Output and Tristate Buffers)	46
Table 122	DDR2/SSTL18 Receiver Characteristics for DDRIO I/O Bank with Fixed Code	47
Table 123	SSTL18 DC Differential Voltage Specification	47
Table 124	SSTL18 AC Differential Voltage Specifications (Applicable to DDRIO Bank Only)	47
Table 125	SSTL18 Minimum and Maximum AC Switching Speed (Applicable to DDRIO Bank Only)	47
Table 126	SSTL18 AC Impedance Specifications (Applicable to DDRIO Bank Only)	47
Table 127	SSTL18 AC Test Parameter Specifications (Applicable to DDRIO Bank Only)	47
Table 128	SSTL15 DC Recommended DC Operating Conditions (for DDRIO I/O Bank Only)	48
Table 129	SSTL15 DC Input Voltage Specification (for DDRIO I/O Bank Only)	48
Table 130	DDR2/SSTL18 Transmitter Characteristics (Output and Tristate Buffers)	48
Table 131	SSTL15 AC SSTL15 Minimum and Maximum AC Switching Speed (for DDRIO I/O Bank Only)	49
Table 132	SSTL15 Minimum and Maximum AC Switching Speed (for DDRIO I/O Bank Only)	49
Table 133	SSTL15 AC Calibrated Impedance Option (for DDRIO I/O Bank Only)	49
Table 134	SSTL15 DC Output Voltage Specification (for DDRIO I/O Bank Only)	49
Table 135	SSTL15 DC Differential Voltage Specification (for DDRIO I/O Bank Only)	49
Table 136	DDR3/SSTL15 Receiver Characteristics for DDRIO I/O Bank – with Calibration Only	50
Table 137	DDR3/SSTL15 Transmitter Characteristics (Output and Tristate Buffers)	50
Table 138	SSTL15 AC Test Parameter Specifications (for DDRIO I/O Bank Only)	50
Table 139	LPDDR DC Recommended DC Operating Conditions	51
Table 140	LPDDR DC Input Voltage Specification	51
Table 141	LPDDR DC Output Voltage Specification Reduced Drive	51
Table 142	LPDDR DC Output Voltage Specification Full Drive	51
Table 143	LPDDR DC Differential Voltage Specification	51
Table 144	LPDDR Receiver Characteristics for DDRIO I/O Bank with Fixed Codes	52
Table 145	LPDDR Reduced Drive for DDRIO I/O Bank (Output and Tristate Buffers)	52
Table 146	LPDDR AC Differential Voltage Specifications (for DDRIO I/O Bank Only)	52
Table 147	LPDDR AC Specifications (for DDRIO I/O Bank Only)	52
Table 148	LPDDR AC Calibrated Impedance Option (for DDRIO I/O Bank Only)	52
Table 149	LPDDR AC Test Parameter Specifications (for DDRIO I/O Bank Only)	52
Table 150	LPDDR-LVCMOS 1.8 V Mode Recommended DC Operating Conditions	53
Table 151	LPDDR-LVCMOS 1.8 V Mode DC Input Voltage Specification	53
Table 152	LPDDR-LVCMOS 1.8 V Mode DC Output Voltage Specification	53
Table 153	LPDDR-LVCMOS 1.8 V Minimum and Maximum AC Switching Speeds	53
Table 154	LPDDR-LVCMOS 1.8 V Calibrated Impedance Option	53
Table 155	LPDDR Full Drive for DDRIO I/O Bank (Output and Tristate Buffers)	53
Table 156	LPDDR-LVCMOS 1.8 V AC Test Parameter Specifications	54
Table 157	LPDDR-LVCMOS 1.8 V Mode Transmitter Drive Strength Specification for DDRIO Bank	54
Table 158	LPDDR-LVCMOS 1.8V AC Switching Characteristics for Receiver (for DDRIO I/O Bank with Fixed Code - Input Buffers)	54
Table 159	LPDDR-LVCMOS 1.8 V AC Switching Characteristics for Transmitter for DDRIO I/O Bank (Output and Tristate Buffers)	54
Table 160	LVDS Recommended DC Operating Conditions	55

Table 161	LVDS DC Input Voltage Specification	55
Table 162	LVDS25 Receiver Characteristics for MSIO I/O Bank (Input Buffers)	56
Table 163	LVDS DC Output Voltage Specification	56
Table 164	LVDS DC Differential Voltage Specification	56
Table 165	LVDS Minimum and Maximum AC Switching Speed	56
Table 166	LVDS AC Impedance Specifications	56
Table 167	LVDS AC Test Parameter Specifications	56
Table 168	LVDS33 Receiver Characteristics for MSIO I/O Bank (Input Buffers)	57
Table 169	LVDS33 Transmitter Characteristics for MSIO I/O Bank (Output and Tristate Buffers)	57
Table 170	LVDS25 Receiver Characteristics for MSIOD I/O Bank (Input Buffers)	57
Table 171	LVDS25 Transmitter Characteristics for MSIO I/O Bank (Output and Tristate Buffers)	57
Table 172	LVDS25 Transmitter Characteristics for MSIOD I/O Bank (Output and Tristate Buffers)	57
Table 173	B-LVDS Recommended DC Operating Conditions	58
Table 174	B-LVDS DC Input Voltage Specification	58
Table 175	B-LVDS DC Output Voltage Specification (for MSIO I/O Bank Only)	58
Table 176	B-LVDS DC Differential Voltage Specification	58
Table 177	B-LVDS Minimum and Maximum AC Switching Speed	58
Table 178	B-LVDS AC Impedance Specifications	58
Table 179	B-LVDS AC Test Parameter Specifications	58
Table 180	B-LVDS AC Switching Characteristics for Receiver for MSIO I/O Bank (Input Buffers)	59
Table 181	B-LVDS AC Switching Characteristics for Receiver for MSIOD I/O Bank (Input Buffers)	59
Table 182	B-LVDS AC Switching Characteristics for Transmitter (for MSIO I/O Bank - Output and Tristate Buffers)	59
Table 183	M-LVDS Recommended DC Operating Conditions	59
Table 184	M-LVDS DC Input Voltage Specification	59
Table 185	M-LVDS AC Switching Characteristics for Receiver (for MSIO I/O Bank - Input Buffers)	60
Table 186	M-LVDS DC Voltage Specification Output Voltage Specification (for MSIO I/O Bank Only)	60
Table 187	M-LVDS Differential Voltage Specification	60
Table 188	M-LVDS Minimum and Maximum AC Switching Speed for MSIO I/O Bank	60
Table 189	M-LVDS AC Impedance Specifications	60
Table 190	M-LVDS AC Test Parameter Specifications	60
Table 191	Mini-LVDS Recommended DC Operating Conditions	61
Table 192	Mini-LVDS DC Input Voltage Specification	61
Table 193	Mini-LVDS DC Output Voltage Specification	61
Table 194	Mini-LVDS DC Differential Voltage Specification	61
Table 195	Mini-LVDS Minimum and Maximum AC Switching Speed	61
Table 196	M-LVDS AC Switching Characteristics for Receiver (for MSIOD I/O Bank - Input Buffers)	61
Table 197	M-LVDS AC Switching Characteristics for Transmitter (for MSIO I/O Bank - Output and Tristate Buffers)	61
Table 198	Mini-LVDS AC Switching Characteristics for Receiver (for MSIO I/O Bank - Input Buffers)	62
Table 199	Mini-LVDS AC Switching Characteristics for Transmitter for MSIO I/O Bank (Output and Tristate Buffers)	62
Table 200	Mini-LVDS AC Switching Characteristics for Transmitter (for MSIOD I/O Bank - Output and Tristate Buffers)	62
Table 201	Mini-LVDS AC Impedance Specifications	62
Table 202	Mini-LVDS AC Test Parameter Specifications	62
Table 203	RSDS Recommended DC Operating Conditions	63
Table 204	RSDS DC Input Voltage Specification	63
Table 205	RSDS DC Output Voltage Specification	63
Table 206	RSDS Differential Voltage Specification	63
Table 207	RSDS Minimum and Maximum AC Switching Speed	63
Table 208	RSDS AC Impedance Specifications	63
Table 209	RSDS AC Test Parameter Specifications	63
Table 210	RSDS AC Switching Characteristics for Receiver (for MSIO I/O Bank - Input Buffers)	64
Table 211	RSDS AC Switching Characteristics for Receiver (for MSIOD I/O Bank - Input Buffers)	64
Table 212	RSDS AC Switching Characteristics for Transmitter (for MSIO I/O Bank - Output and Tristate Buffers)	64
Table 213	RSDS AC Switching Characteristics for Transmitter (for MSIOD I/O Bank - Output and Tristate Buffers)	64

Table 214	LVPECL Recommended DC Operating Conditions	64
Table 215	LVPECL Receiver Characteristics for MSIO I/O Bank	65
Table 216	LVPECL DC Input Voltage Specification	65
Table 217	LVPECL DC Differential Voltage Specification	65
Table 218	LVPECL Minimum and Maximum AC Switching Speeds	65
Table 219	Input Data Register Propagation Delays	67
Table 220	Output/Enable Data Register Propagation Delays	69
Table 221	Input DDR Propagation Delays	71
Table 222	Output DDR Propagation Delays	74
Table 223	Combinatorial Cell Propagation Delays	76
Table 224	Register Delays	77
Table 225	150 Device Global Resource	78
Table 226	090 Device Global Resource	78
Table 227	050 Device Global Resource	78
Table 228	025 Device Global Resource	78
Table 229	010 Device Global Resource	79
Table 230	005 Device Global Resource	79
Table 231	RAM1K18 – Dual-Port Mode for Depth × Width Configuration 1K × 18	79
Table 232	RAM1K18 – Dual-Port Mode for Depth × Width Configuration 2K × 9	80
Table 233	RAM1K18 – Dual-Port Mode for Depth × Width Configuration 4K × 4	81
Table 234	RAM1K18 – Dual-Port Mode for Depth × Width Configuration 8K × 2	83
Table 235	RAM1K18 – Dual-Port Mode for Depth × Width Configuration 16K × 1	84
Table 236	RAM1K18 – Two-Port Mode for Depth × Width Configuration 512 × 36	85
Table 237	μSRAM (RAM64x18) in 64 × 18 Mode	86
Table 238	μSRAM (RAM64x16) in 64 × 16 Mode	87
Table 239	μSRAM (RAM128x9) in 128 × 9 Mode	88
Table 240	μSRAM (RAM128x8) in 128 × 8 Mode	89
Table 241	μSRAM (RAM256x4) in 256 × 4 Mode	91
Table 242	μSRAM (RAM512x2) in 512 × 2 Mode	92
Table 243	μSRAM (RAM1024x1) in 1024 × 1 Mode	93
Table 244	JTAG Programming (Fabric Only)	94
Table 245	JTAG Programming (eNVM Only)	95
Table 246	JTAG Programming (Fabric and eNVM)	95
Table 247	2 Step IAP Programming (Fabric Only)	95
Table 248	2 Step IAP Programming (eNVM Only)	96
Table 249	2 Step IAP Programming (Fabric and eNVM)	96
Table 250	SmartFusion2 Cortex-M3 ISP Programming (Fabric Only)	96
Table 251	SmartFusion2 Cortex-M3 ISP Programming (eNVM Only)	96
Table 252	SmartFusion2 Cortex-M3 ISP Programming (Fabric and eNVM)	97
Table 253	Programming Times with 100 kHz, 25 MHz, and 12.5 MHz SPI Clock Rates (Fabric Only)	97
Table 254	Programming Times with 100 kHz, 25 MHz, and 12.5 MHz SPI Clock Rates (eNVM Only)	97
Table 255	Programming Times with 100 kHz, 25 MHz, and 12.5 MHz SPI Clock Rates (Fabric and eNVM)	98
Table 256	JTAG Programming (Fabric Only)	99
Table 257	JTAG Programming (eNVM Only)	99
Table 258	JTAG Programming (Fabric and eNVM)	99
Table 259	2 Step IAP Programming (Fabric Only)	100
Table 260	2 Step IAP Programming (eNVM Only)	100
Table 261	2 Step IAP Programming (Fabric and eNVM)	100
Table 262	SmartFusion2 Cortex-M3 ISP Programming (Fabric Only)	101
Table 263	SmartFusion2 Cortex-M3 ISP Programming (eNVM Only)	101
Table 264	SmartFusion2 Cortex-M3 ISP Programming (Fabric and eNVM)	101
Table 265	Programming Times with 100 kHz, 25 MHz, and 12.5 MHz SPI Clock Rates (Fabric Only)	102
Table 266	Programming Times with 100 kHz, 25 MHz, and 12.5 MHz SPI Clock Rates (eNVM Only)	102
Table 267	Programming Times with 100 kHz, 25 MHz, and 12.5 MHz SPI Clock Rates (Fabric and eNVM)	102
Table 268	Math Blocks with all Registers Used	103
Table 269	Math Block with Input Bypassed and Output Registers Used	103
Table 270	Math Block with Input Register Used and Output in Bypass Mode	104
Table 271	Math Block with Input and Output in Bypass Mode	104
Table 272	eNVM Read Performance	104

Table 273	eNVM Page Programming	104
Table 274	SRAM PUF	105
Table 275	Non-Deterministic Random Bit Generator (NRBG)	106
Table 276	Cryptographic Block Characteristics	106
Table 277	Electrical Characteristics of the Crystal Oscillator – High Gain Mode (20 MHz)	107
Table 278	Electrical Characteristics of the Crystal Oscillator – Medium Gain Mode (2 MHz)	108
Table 279	Electrical Characteristics of the Crystal Oscillator – Low Gain Mode (32 kHz)	108
Table 280	Electrical Characteristics of the 50 MHz RC Oscillator	109
Table 281	Electrical Characteristics of the 1 MHz RC Oscillator	109
Table 282	IGLOO2 and SmartFusion2 SoC FPGAs CCC/PLL Specification	110
Table 283	IGLOO2 and SmartFusion2 SoC FPGAs CCC/PLL Jitter Specifications	111
Table 284	JTAG 1532 for 005, 010, 025, and 050 Devices	112
Table 285	JTAG 1532 for 060, 090, and 150 Devices	112
Table 286	System Controller SPI Characteristics for All Devices	113
Table 287	Supported I/O Configurations for System Controller SPI (for MSIO Bank Only)	113
Table 288	Power-up to Functional Times for SmartFusion2	114
Table 289	Power-up to Functional Times for IGLOO2	115
Table 290	DEVRST_N Characteristics for All Devices	116
Table 291	DEVRST_N to Functional Times for SmartFusion2	116
Table 292	DEVRST_N to Functional Times for IGLOO2	118
Table 293	Flash*Freeze Entry and Exit Times	119
Table 294	DDR Memory Interface Characteristics	120
Table 295	SFP Transceiver Electrical Characteristics	120
Table 296	Transmitter Parameters	121
Table 297	Receiver Parameters	122
Table 298	SerDes Protocol Compliance	122
Table 299	SerDes Reference Clock AC Specifications	123
Table 300	HCSL Minimum and Maximum DC Input Levels (Applicable to SerDes REFCLK Only)	123
Table 301	HCSL Minimum and Maximum AC Switching Speeds (Applicable to SerDes REFCLK Only)	123
Table 302	Maximum Frequency for MSS Main Clock	123
Table 303	I2C Characteristics	124
Table 304	I2C Switching Characteristics	125
Table 305	SPI Characteristics for All Devices	126
Table 306	CAN Controller Characteristics	128
Table 307	USB Characteristics	128
Table 308	MMUART Characteristics	129
Table 309	Maximum Frequency for HPMS Main Clock	129
Table 310	SPI Characteristics for All Devices	129

1 Revision History

The revision history describes the changes that were implemented in the document. The changes are listed by revision, starting with the most current publication.

1.1 Revision 11.0

The following is a summary of the changes in revision 11.0 of this document.

- Updated [Table 24](#), page 22 with minimum and maximum values for input current low and high (SAR 73114 and 80314).
- Added [Non-Deterministic Random Bit Generator \(NRBG\) Characteristics](#), page 106 (SAR 73114 and 79517).
- Added 060 device in [Table 282](#), page 110 (SAR 79860).
- Added [DEVRST_N to Functional Times](#), page 116 (SAR 73114).
- Added [Cryptographic Block Characteristics](#), page 106 (SAR 73114 and 79516).
- Update [Table 296](#), page 121 with VTX-AMP details (SAR 81756).
- Update note in [Table 297](#), page 122 (SAR 74570 and 80677).
- Update [Table 298](#), page 122 with generic EPCS details (SAR 75307).
- Added [Table 308](#), page 129 (SAR 50424).

1.2 Revision 10.0

The following is a summary of the changes in revision 10.0 of this document.

- The Surge Current on VDD during DEVRST_B Assertion and Surge Current on VDD during Digest Check using System Services tables were deleted and added reference to [AC393: Board Design Guidelines for SmartFusion2 SoC and IGLOO2 FPGAs Application Note](#). (SAR 76865 and 76623).
- Added 060 device in [Table 4](#), page 6 (SAR 76383).
- Updated [Table 24](#), page 22 for ramp time input (SAR 72103).
- Added 060 device details in [Table 284](#), page 112 (SAR 74927).
- Updated [Table 290](#), page 116 for name change (SAR 74925).
- Updated [Table 283](#), page 111 for 060 FG676 Package details (SAR 78849).
- Updated [Table 305](#), page 126 for SmartFusion2 and [Table 310](#), page 129 for IGLOO2 for SPI timing and Fmax (SAR 56645, 75331).
- Updated [Table 293](#), page 119 for Flash*Freeze entry and exit times (SAR 75329, 75330).
- Updated [Table 297](#), page 122 for RX-CID information (SAR 78271).
- Added [Table 8](#), page 8 and [Figure 1](#), page 9 (SAR 78932).
- Updated [Table 223](#), page 76 for timing characteristics and [Table 224](#), page 77 (SAR 75998).
- Added [SRAM PUF](#), page 105 (SAR 64406).
- Added a footnote on digest cycle in [Table 5](#), page 7 (SAR 79812).

1.3 Revision 9.0

The following is a summary of the changes in revision 9.0 of this document.

- Added a note in [Table 5](#), page 7 (SAR 71506).
- Added a note in [Table 6](#), page 8 (SAR 74616).
- Added a note in [Figure 3](#), page 17 (SAR 71506).
- Updated Quiescent Supply Current for 060 in [Table 11](#), page 12 and [Table 12](#), page 13 (SAR 74483).
- Updated programming currents for 060 in [Table 13](#), page 13, [Table 14](#), page 13, and [Table 15](#), page 14.
- Added DEVRST_B assertion tables (SAR 74708).
- Updated I/O speeds for LVDS 3.3 V in [Table 18](#), page 19 and [Table 21](#), page 20 (SAR 69829).
- Updated [Table 24](#), page 22 (SAR 69418).
- Updated [Table 25](#), page 22, [Table 26](#), page 23, [Table 27](#), page 23 (SAR 74570).
- Updated all AC/DC table to link to the [Input Capacitance, Leakage Current, and Ramp Time](#), page 22 for reference (SAR 69418).

- Added [Table 244](#), page 94 and [Table 256](#), page 99 (SAR 73971).
- Updated the [SerDes Electrical and Timing AC and DC Characteristics](#), page 121 (SAR 71171).
- Added the [DEVRST_N Characteristics](#), page 116 (SAR 64100, 72103).
- Added [Table 298](#), page 122 (SAR 71897).
- Updated [Table 25](#), page 22, [Table 26](#), page 23, and [Table 27](#), page 23 (SAR 74570).
- Added 060 devices in [Table 277](#), page 107, [Table 278](#), page 108, and [Table 279](#), page 108 (SAR 57898).
- Updated duty cycle parameter of crystal in [Table 280](#), page 109 and [Table 281](#), page 109 (SAR 57898).
- Added 32 KHz mode PLL acquisition time in [Table 282](#), page 110 (SAR 68281).
- Updated [Table 293](#), page 119 for 060 devices (SAR 57828).
- Updated [Table 297](#), page 122 for CID value (SAR 70878).

1.4 Revision 8.0

The following is a summary of the changes in revision 8.0 of this document.

- Updated [Table 11](#), page 12 (SAR 69218).
- Updated [Table 12](#), page 13 (SAR 69218).
- Updated [Table 283](#), page 111 (SAR 69000).

1.5 Revision 7.0

The following is a summary of the changes in revision 7.0 of this document.

- Updated [Table 1](#), page 4(SAR 68620).

1.6 Revision 6.0

The following is a summary of the changes in revision 6.0 of this document.

- Updated [Table 5](#), page 7 (SAR 65949).
- Updated [Table 9](#), page 10 (SAR 62995).
- Updated [Table 123](#), page 47 and [Table 133](#), page 49 (SAR 67210).
- Added [Embedded NVM \(eNVM\) Characteristics](#), page 104 (SAR 52509).
- Updated [Table 277](#), page 107 (SAR 64855).
- Updated [Table 282](#), page 110 (SAR 65958 and SAR 56666).
- Added [DDR Memory Interface Characteristics](#), page 120 (SAR 66223).
- Added [SFP Transceiver Characteristics](#), page 120 (SAR 63105).
- Updated [Table 302](#), page 123 and [Table 309](#), page 129 (SAR 66314).

1.7 Revision 5.0

The following is a summary of the changes in revision 5.0 of this document.

- Updated [Table 1](#), page 4.
- Updated [Table 4](#), page 6 for T_J symbol information.
- Updated [Table 5](#), page 7 (SAR 63109).
- Updated [Table 9](#), page 10.
- Updated [Table 282](#), page 110 (SAR 62012).
- Added [Table 290](#), page 116 (SAR 64100).
- Added [Table 306](#), page 128, [Table 307](#), page 128 (SAR 50424).

1.8 Revision 4.0

The following is a summary of the changes in revision 4.0 of this document.

- Updated [Table 1](#), page 4. Changed the Status of 090 devices to "Production" (SAR 62750).
- Updated [Figure 10](#), page 70. Removed inverter bubble from DDR_IN latch (SAR 61418).
- Updated [SerDes Electrical and Timing AC and DC Characteristics](#), page 121 (SAR 62836).

1.9 Revision 3.0

In revision 3.0 of this document, the Theta B/C columns and FCS325 package was updated. For more information, see [Table 9](#), page 10 (SAR 62002).

1.10 Revision 2.0

The following is a summary of the changes in revision 2.0 of this document.

- [Table 1](#), page 4 was updated (SAR 59056).
- [Table 7](#), page 8 temperature and data retention information was updated SAR (61363).
- Storage Operating Table was updated and split into three tables – [Table 5](#), page 7, [Table 7](#), page 8 (SAR 58725).
- Updated Theta B/C columns and FCS325 package in [Table 9](#), page 10 (SAR 62002).
- Added 090-FCS325 thermal resistance to [Table 9](#), page 10 (SAR 59384).
- TQ144 package was added to [Table 9](#), page 10 (SAR 57708).
- Added PLL jitter data for the VF400 package (SAR 53162).
- Added Additional Worst Case IDD to [Table 11](#), page 12 and [Table 12](#), page 13 (SAR 59077).
- [Table 13](#), page 13, [Table 14](#), page 13, and [Table 15](#), page 14 were added to verify Inrush currents (SAR 56348).
- [Table 18](#), page 19 and [Table 21](#), page 20 – I/O speeds were replaced.
- Max speed was changed in [Table 41](#), page 26 (SAR 57221) and in [Table 52](#), page 29 (SAR 57113).
- [Minimum and Maximum DC/AC Input and Output Levels Specification](#), page 29 and [Table 49](#), page 29–[Table 57](#), page 31 were added.
- Added Cloud to [Table 89](#), page 39 (SAR 56238).
- Removed "Rs" information in DDR Timing Measurement [Table 123](#), page 47, [Table 133](#), page 49, and [Table 144](#), page 52.
- Updated drive programming for M/B-LVDS outputs (SAR 58154).
- Added an inverter bubble to DDR_IN latch in [Figure 10](#), page 70 (SAR 61418).
- QF waveform in [Figure 11](#), page 71 was updated (SAR 59816).
- uSRAM Write Clock minimum values were updated in [Table 237](#), page 86–[Table 243](#), page 93 (SAR 55236).
- Fixed typo in the 32 kHz Crystal (XTAL) oscillator accuracy data section (SAR 59669).
- The "On-Chip Oscillator" section was split, and the [Embedded NVM \(eNVM\) Characteristics](#), page 104 was added. [Table 277](#), page 107–[Table 281](#), page 109 were revised.(SARs 57898 and 59669).
- PLL VCP Frequency and conditions were added to [Table 282](#), page 110 (SAR 57416).
- Fixed typo for PLL jitter data in the 100-400 MHz range (SAR 60727).
- Updated FCCC information in [Table 282](#), page 110 and [Table 283](#), page 111 (SAR 60799).
- Device 025 specifications were added to [Table 283](#), page 111 (SAR 51625).
- JTAG [Table 284](#), page 112 was replaced (SAR 51188).
- Flash*Freeze [Table 293](#), page 119 was replaced (SAR 57828).
- Added support for HCSL I/O Standard for SERDES reference clocks in [Table 300](#), page 123 and [Table 301](#), page 123 (SAR 50748).
- Tir and Tif parameters were added to [Table 303](#), page 124 (SAR 52203).
- Speed grade consistency was fixed in tables throughout the datasheet (SAR 50722).
- Added jitter attenuation information (SAR 59405).

1.11 Revision 1.0

The following is a summary of the changes in revision 1.0 of this document.

- The IGLOO2 v2 and the SmartFusion2 v5 datasheets are combined into this single product family datasheet.

2 IGLOO2 FPGA and SmartFusion2 SoC FPGA

Microsemi's mainstream SmartFusion[®]2 SoC and IGLOO[®]2 FPGA families integrate an industry standard 4-input lookup table-based (LUT) FPGA fabric with integrated math blocks, multiple embedded memory blocks, and high-performance SerDes communication interfaces on a single chip. Both families benefit from low-power flash technology and are the most secure and reliable FPGAs in the industry. These next generation devices offer up to 150K Logic Elements, up to 5 MBs of embedded RAM, up to 16 SerDes lanes, and up to four PCI Express Gen 2 endpoints, as well as integrated hard DDR3 memory controllers with error correction.

SmartFusion2 devices integrate an entire low-power, real-time microcontroller subsystem (MSS) with a rich set of industry-standard peripherals including Ethernet, USB, and CAN, while IGLOO2 devices integrate a high-performance memory subsystem with on-chip flash, 32 Kbyte embedded SRAM, and multiple DMA controllers.

2.1 Device Status

The following table shows the design security densities and development status of the IGLOO2 FPGA and SmartFusion2 SoC FPGA devices.

Table 1 • IGLOO2 and SmartFusion2 Design Security Densities

Design Security Device Densities	Status
005	Production
010, 010T	Production
025, 025T	Production
050, 050T	Production
060, 060T	Production
090, 090T	Production
150, 150T	Production

The following table shows the data security densities and development status of the IGLOO2 FPGA and SmartFusion2 SoC FPGA devices.

Table 2 • IGLOO2 and SmartFusion2 Data Security Densities

Data Security Device Densities	Status
005S	Production
010TS	Production
025TS	Production
050TS	Production
060TS	Production
090TS	Production
150TS	Production

2.2 References

The following documents are recommended references:

- *PB0121: IGLOO2 Product Brief*
- *DS0124: IGLOO2 Pin Descriptions*
- *PB0115: SmartFusion2 SoC FPGA Product Brief*
- *DS0115: SmartFusion2 Pin Descriptions*

All product documentation for IGLOO2 and SmartFusion2 is available at:

<http://www.microsemi.com/products/fpga-soc/fpga/igloo2-fpga>

<http://www.microsemi.com/products/fpga-soc/soc-fpga/smartfusion2#overview>

2.3 Electrical Specifications

2.3.1 Operating Conditions

The following table lists the stress limits. Stress applied above the specified limit may cause permanent damage to the device. Exposure to absolute maximum rating conditions for extended periods may affect device reliability.

Absolute maximum ratings are stress ratings only; functional operation of the device at these or any other conditions beyond those listed under the recommended operating conditions specified in the following table are not implied.

Table 3 • Absolute Maximum Ratings

Parameter	Symbol	Min	Max	Unit
DC core supply voltage. Must always power this pin.	V_{DD}	-0.3	1.32	V
Power supply for charge pumps (for normal operation and programming). Must always power this pin.	V_{PP}	-0.3	3.63	V
Analog power pad for MDDR PLL	MSS_MDDR_PLL_VDDA	-0.3	3.63	V
Analog power pad for MDDR PLL	HPMS_MDDR_PLL_VDDA	-0.3	3.63	V
Analog power pad for FDDR PLL	FDDR_PLL_VDDA	-0.3	3.63	V
Analog power pad for MDDR PLL	PLL0_PLL1_MSS_MDDR_VDDA	-0.3	3.63	V
Analog power pad for MDDR PLL	PLL0_PLL1_HPMS_MDDR_VDDA	-0.3	3.63	V
Analog power pad for PLL0-5	CCC_XX[01]_PLL_VDDA	-0.3	3.63	V
High supply voltage for PLL SerDes[01]	SERDES_[01]_PLL_VDDA	-0.3	3.63	V
Analog power for SerDes[01] PLL lane0 to lane3. This is a 2.5 V SerDes internal PLL supply.	SERDES_[01]_L[0123]_VDDAPLL	-0.3	2.75	V
TX/RX analog I/O voltage. Low voltage power for the lanes of SerDesIF0. This is a 1.2 V SerDes PMA supply.	SERDES_[01]_L[0123]_VDDAIO	-0.3	1.32	V
PCIe/PCS power supply	SERDES_[01]_VDD	-0.3	1.32	V
DC FPGA I/O buffer supply voltage for MSIO I/O bank	V_{DDIx}	-0.3	3.63	V
DC FPGA I/O buffer supply voltage for MSIOD/DDRIO I/O banks	V_{DDIx}	-0.3	2.75	V
I/O Input voltage for MSIO I/O bank	V_I	-0.3	3.63	V
I/O Input voltage for MSIOD/DDRIO I/O bank	V_I	-0.3	2.75	V
Analog sense circuit supply of embedded nonvolatile memory (eNVM). Must be shorted to V_{PP} .	V_{PPNVM}	-0.3	3.63	V
Storage temperature ¹	T_{STG}	-65	150	°C
Junction temperature	T_J	-55	135	°C

1. For flash programming and retention maximum limits, see Table 5, page 7. For recommended operating conditions, see Table 4, page 6.

Table 4 • Recommended Operating Conditions

Parameter	Symbol	Min	Typ	Max	Unit	Conditions
Operating junction temperature	T_J	0	25	85	°C	Commercial
		-40	25	100	°C	Industrial
Programming junction temperatures ¹	T_J	0	25	85	°C	Commercial
		-40	25	100	°C	Industrial
DC core supply voltage. Must always power this pin.	V_{DD}	1.14	1.2	1.26	V	
Power supply for charge pumps (for normal operation and programming) for the 005, 010, 025, 050, 060 devices	V_{PP}	2.375	2.5	2.625	V	2.5 V range
		3.15	3.3	3.45	V	3.3 V range
Power supply for charge pumps (for normal operation and programming) for the 090 and 150 devices	V_{PP}	3.15	3.3	3.45	V	3.3 V range
Analog power pad for MDDR PLL	MSS_MDDR_PLL_VDDA	2.375	2.5	2.625	V	2.5 V range
		3.15	3.3	3.45	V	3.3 V range
Analog power pad for MDDR PLL	HPMS_MDDR_PLL_VDDA	2.375	2.5	2.625	V	2.5 V range
		3.15	3.3	3.45	V	3.3 V range
Analog power pad for FDDR PLL	FDDR_PLL_VDDA	2.375	2.5	2.625	V	2.5 V range
		3.15	3.3	3.45	V	3.3 V range
Analog power pad for MDDR PLL	PLL0_PLL1_MSS_MDDR_V DDA	2.375	2.5	2.625	V	2.5 V range
		3.15	3.3	3.45	V	3.3 V range
Analog power pad for MDDR PLL	PLL0_PLL1_HPMS_MDDR_ VDDA	2.375	2.5	2.625	V	2.5 V range
		3.15	3.3	3.45	V	3.3 V range
Analog power pad for PLL0 to PLL5	CCC_XX[01]_PLL_VDDA	2.375	2.5	2.625	V	2.5 V range
		3.15	3.3	3.45	V	3.3 V range
High supply voltage for PLL SerDes[01]	SERDES_[01]_PLL_VDDA	2.375	2.5	2.625	V	2.5 V range
		3.15	3.3	3.45	V	3.3 V range
Analog power for SerDes[01] PLL Lane 0 to Lane 3. This is a 2.5 V SerDes internal PLL supply.	SERDES_[01]_L[0123]_VD DAPLL	2.375	2.5	2.625	V	
TX/RX analog I/O voltage. Low voltage power for the lanes of SerDesIF0. This is a 1.2 V SerDes PMA supply.	SERDES_[01]_L[0123]_VD DAIO	1.14	1.2	1.26	V	
PCIe/PCS power supply	SERDES_[01]_VDD	1.14	1.2	1.26	V	
1.2 V DC supply voltage	V_{DDix}	1.14	1.2	1.26	V	
1.5 V DC supply voltage	V_{DDix}	1.425	1.5	1.575	V	
1.8 V DC supply voltage	V_{DDix}	1.71	1.8	1.89	V	
2.5 V DC supply voltage	V_{DDix}	2.375	2.5	2.625	V	

Table 4 • Recommended Operating Conditions (continued)

Parameter	Symbol	Min	Typ	Max	Unit	Conditions
3.3 V DC supply voltage	V_{DDIX}	3.15	3.3	3.45	V	
LVDS differential I/O	V_{DDIX}	2.375	2.5	3.45	V	
B-LVDS, M-LVDS, Mini-LVDS, RSDS differential I/O	V_{DDIX}	2.375	2.5	2.625	V	
LVPECL differential I/O	V_{DDIX}	3.15	3.3	3.45	V	
Reference voltage supply for FDDR (Bank0) and MDDR (Bank5)	V_{REFX}	0.49 × V_{DDIX}	0.5 × V_{DDIX}	0.51 × V_{DDIX}	V	
Analog sense circuit supply of embedded nonvolatile memory (eNVM). Must be shorted to V_{PP} .	V_{PPNVM}	2.375 3.15	2.5 3.3	2.625 3.45	V	2.5 V range 3.3 V range

1. Programming at Industrial temperature range is available only with $V_{PP} = 3.3$ V.

Note: Power supply ramps must all be strictly monotonic, without plateaus.

Table 5 • FPGA Operating Limits

Product Grade	Element	Programming Temperature	Operating Temperature	Programming Cycles	Digest Temperature	Digest Cycles	Retention (Biased/Unbiased)
Commercial	FPGA	Min $T_J = 0$ °C Max $T_J = 85$ °C	Min $T_J = 0$ °C Max $T_J = 85$ °C	500	Min $T_J = 0$ °C Max $T_J = 85$ °C	2000	20 years
Industrial ¹	FPGA	Min $T_J = -40$ °C Max $T_J = 100$ °C	Min $T_J = -40$ °C Max $T_J = 100$ °C	500	Min $T_J = -40$ °C Max $T_J = 100$ °C	2000	20 years

1. Programming at Industrial temperature range is available only with $V_{PP} = 3.3$ V.

Note: The retention specification is defined as the total number of programming and digest cycles. For example, 20 years of retention after 500 programming cycles.

Note: The digest cycle specification is 2000 digest cycles for every program cycle with a maximum of 500 programming cycles.

Note: If your product qualification requires accelerated programming cycles, see [Microsemi SoC Products Quality and Reliability Report](#) about recommended methodologies.

The following table lists the embedded operating flash limits.

Table 6 • Embedded Operating Flash Limits

Product Grade	Element	Programming Temperature	Maximum Operating Temperature	Programming Cycles	Retention (Biased/Unbiased)
Commercial	Embedded flash	Min $T_J = 0\text{ }^\circ\text{C}$ Max $T_J = 85\text{ }^\circ\text{C}$	Min $T_J = 0\text{ }^\circ\text{C}$ Max $T_J = 85\text{ }^\circ\text{C}$	< 1000 cycles per page, up to two million cycles per eNVM array	20 years
				Min $T_J = 0\text{ }^\circ\text{C}$ Max $T_J = 85\text{ }^\circ\text{C}$	< 10000 cycles per page, up to 20 million cycles per eNVM array
Industrial	Embedded flash	Min $T_J = -40\text{ }^\circ\text{C}$ Max $T_J = 100\text{ }^\circ\text{C}$	Min $T_J = -40\text{ }^\circ\text{C}$ Max $T_J = 100\text{ }^\circ\text{C}$	< 1000 cycles per page, up to two million cycles per eNVM array	20 years
				Min $T_J = -40\text{ }^\circ\text{C}$ Max $T_J = 100\text{ }^\circ\text{C}$	< 10000 cycles per page, up to 20 million cycles per eNVM array

Note: If your product qualification requires accelerated programming cycles, see [Microsemi SoC Products Quality and Reliability Report](#) about recommended methodologies.

Table 7 • Device Storage Temperature and Retention

Product Grade	Storage Temperature (Tstg)	Retention
Commercial	Min $T_J = 0\text{ }^\circ\text{C}$ Max $T_J = 85\text{ }^\circ\text{C}$	20 years
Industrial	Min $T_J = -40\text{ }^\circ\text{C}$ Max $T_J = 100\text{ }^\circ\text{C}$	20 years

Table 8 • High Temperature Data Retention (HTR) Lifetime

T_J (C)	HTR Lifetime ¹ (yrs)
90	20.5
95	20.5
100	20.5
105	17.0
110	15.0
115	13.0
120	11.5
125	10.0
130	8.0
135	6.0
140	4.5
145	3.0
150	1.5

1. HTR Lifetime is the period during which a verify failure is not expected due to flash leakage.

Figure 1 • High Temperature Data Retention (HTR)

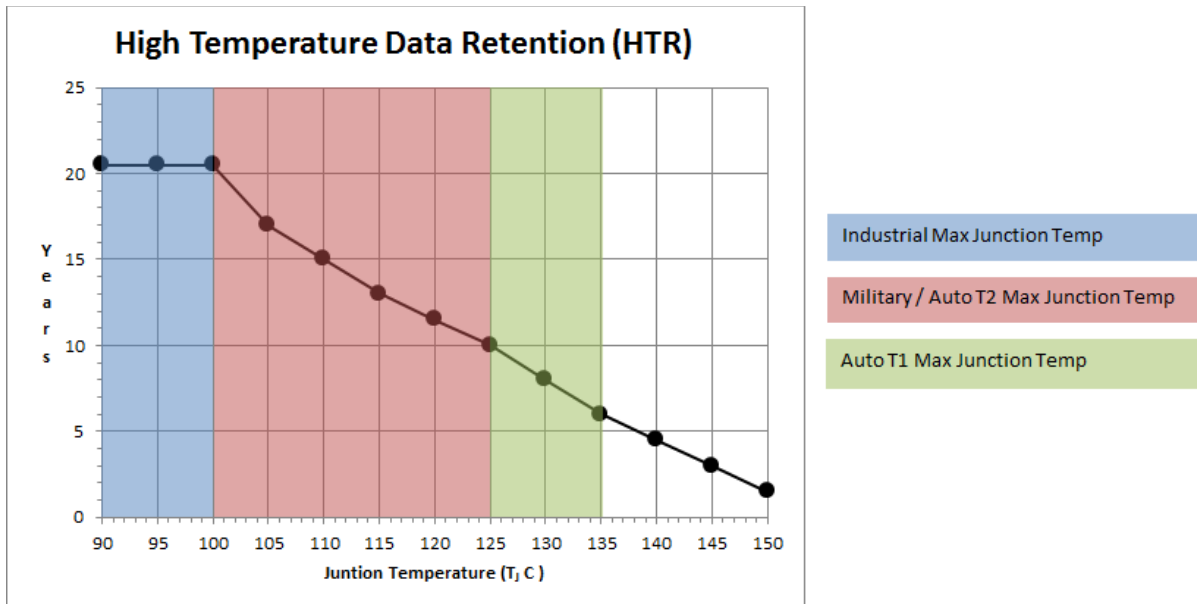

2.3.1.1 Overshoot/Undershoot Limits

For AC signals, the input signal may undershoot during transitions to -1.0 V for no longer than 10% of the period. The current during the transition must not exceed 100 mA.

For AC signals, the input signal may overshoot during transitions to $V_{CC1} + 1.0$ V for no longer than 10% of the period. The current during the transition must not exceed 100 mA.

Note: The above specifications do not apply to the PCI standard. The IGLOO2 and SmartFusion2 PCI I/Os are compliant with the PCI standard including the PCI overshoot/undershoot specifications.

2.3.1.2 Thermal Characteristics

The temperature variable in the Microsemi SoC Products Group Designer software refers to the junction temperature, not the ambient, case, or board temperatures. This is an important distinction because dynamic and static power consumption causes the chip's junction temperature to be higher than the ambient, case, or board temperatures.

EQ1 through EQ3 give the relationship between thermal resistance, temperature gradient, and power.

$$\theta_{JA} = \frac{T_J - T_A}{P}$$

EQ 1

$$\theta_{JB} = \frac{T_J - T_B}{P}$$

EQ 2

$$\theta_{JC} = \frac{T_J - T_C}{P}$$

EQ 3

where

- θ_{JA} = Junction-to-air thermal resistance
- θ_{JB} = Junction-to-board thermal resistance
- θ_{JC} = Junction-to-case thermal resistance
- T_J = Junction temperature
- T_A = Ambient temperature
- T_B = Board temperature (measured 1.0 mm away from the package edge)
- T_C = Case temperature
- P = Total power dissipated by the device

Table 9 • Package Thermal Resistance of SmartFusion2 and IGLOO2 Devices

Device	Still Air	1.0 m/s	2.5 m/s	θ_{JB}	θ_{JC}	Unit
	θ_{JA}					
005						
FG484	19.36	15.81	14.63	9.74	5.27	°C/W
VF256	41.30	38.16	35.30	28.41	3.94	°C/W
VF400	20.19	16.94	15.41	8.86	4.95	°C/W
TQ144	42.80	36.80	34.50	37.20	10.80	°C/W
010						
FG484	18.22	14.83	13.62	8.83	4.92	°C/W
VF256	37.36	34.26	31.45	24.84	7.89	°C/W
VF400	19.40	15.75	14.22	8.11	4.22	°C/W
TQ144	38.60	32.60	30.30	31.80	8.60	°C/W
025						
FG484	17.03	13.66	12.45	7.66	4.18	°C/W
VF256	33.85	30.59	27.85	21.63	6.13	°C/W
VF400	18.36	14.89	13.36	7.12	3.41	°C/W
FCS325	29.17	24.87	23.12	14.44	2.31	°C/W
050						
FG484	15.29	12.19	10.99	6.27	3.24	°C/W
FG896	14.70	12.50	10.90	7.20	4.90	°C/W
VF400	17.53	14.17	12.63	6.32	2.81	°C/W
FCS325	27.38	23.18	21.41	12.47	1.59	°C/W
060						
FG484	15.40	12.06	10.85	6.14	3.15	°C/W
FG676	15.49	12.21	11.06	7.07	3.87	°C/W
VF400	17.45	14.01	12.47	6.22	2.69	°C/W
FCS325	27.03	22.91	21.25	12.33	1.54	°C/W
090						
FG484	14.64	11.37	10.16	5.43	2.77	°C/W
FG676	14.52	11.19	10.37	6.17	3.24	°C/W
FCS325	26.63	22.26	20.13	14.24	2.50	°C/W

Table 9 • Package Thermal Resistance of SmartFusion2 and IGLOO2 Devices (continued)

Device	Still Air	1.0 m/s	2.5 m/s	θ_{JB}	θ_{JC}	Unit
	θ_{JA}					
150						
FC1152	9.08	6.81	5.87	2.56	0.38	°C/W
FCS536	15.01	12.06	10.76	3.69	1.55	°C/W
FCV484	16.21	13.11	11.84	6.73	0.10	°C/W

2.3.1.2.1 Theta-JA

Junction-to-ambient thermal resistance (θ_{JA}) is determined under standard conditions specified by JEDEC (JESD-51), but it has little relevance in the actual performance of the product. It must be used with caution, but it is useful for comparing the thermal performance of one package with another.

The maximum power dissipation allowed is calculated using EQ4.

$$\text{Maximum power allowed} = \frac{T_{J(\text{MAX})} - T_{A(\text{MAX})}}{\theta_{JA}}$$

EQ 4

The absolute maximum junction temperature is 100 °C. EQ5 shows a sample calculation of the absolute maximum power dissipation allowed for the M2GL050T-FG896 package at commercial temperature and in still air, where:

$$\theta_{JA} = 14.7 \text{ °C/W (taken from Table 9, page 10).}$$

$$T_A = 85 \text{ °C}$$

$$\text{Maximum power allowed} = \frac{100 \text{ °C} - 85 \text{ °C}}{14.7 \text{ °C/W}} = 1.088 \text{ W}$$

EQ 5

The power consumption of a device can be calculated using the Microsemi SoC Products Group power calculator. The device's power consumption must be lower than the calculated maximum power dissipation by the package.

If the power consumption is higher than the device's maximum allowable power dissipation, a heat sink may be attached to the top of the case, or the airflow inside the system must be increased.

2.3.1.2.2 Theta-JB

Junction-to-board thermal resistance (θ_{JB}) measures the ability of the package to dissipate heat from the surface of the chip to the PCB. As defined by the JEDEC (JESD-51) standard, the thermal resistance from the junction to the board uses an isothermal ring cold plate zone concept. The ring cold plate is simply a means to generate an isothermal boundary condition at the perimeter. The cold plate is mounted on a JEDEC standard board with a minimum distance of 5.0 mm away from the package edge.

2.3.1.2.3 Theta-JC

Junction-to-case thermal resistance (θ_{JC}) measures the ability of a device to dissipate heat from the surface of the chip to the top or bottom surface of the package. It is applicable to packages used with external heat sinks. Constant temperature is applied to the surface, which acts as a boundary condition.

This only applies to situations where all or nearly all of the heat is dissipated through the surface in consideration.

2.3.1.3 ESD Performance

See *RT0001: Microsemi Corporation - SoC Products Reliability Report* for information about ESD.

2.3.2 Power Consumption

The following sections describe the power consumptions of the devices.

2.3.2.1 Quiescent Supply Current

Table 10 • Quiescent Supply Current Characteristics

Power Supplies/Blocks	Modes and Configurations	
	Non-Flash*Freeze	Flash*Freeze
FPGA Core	On	Off
V _{DD} /SERDES_[01]_VDD ¹	On	On
V _{PP} /V _{PPNVM}	On	On
HPMS_MDDR_PLL_VDDA/FDDR_PLL_VDDA/ CCC_XX[01]_PLL_VDDA/PLL0_PLL1_HPMS_MDDR_VDD A	0 V	0 V
SERDES_[01]_PLL_VDDA ²	0 V	0 V
SERDES_[01]_L[0123]_VDDAPLL/VDD_2V5 ²	On	On
SERDES_[01]_L[0123]_VDDAIIO ²	On	On
V _{DDIx} ^{3, 4}	On	On
V _{REFx}	On	On
MSSDDR CLK	32 kHz	32 kHz
RAM	On	Sleep state
System controller	50 MHz	50 MHz
50 MHz oscillator (enable/disable)	Enable	Disabled
1 MHz oscillator (enable/disable)	Disabled	Disabled
Crystal oscillator (enable/disable)	Disabled	Disabled

1. SERDES_[01]_VDD Power Supply is shorted to V_{DD}.
2. SerDes and DDR blocks to be unused.
3. V_{DDIx} has been set to ON for test conditions as described. Banks on the east side should always be powered with the appropriate V_{DDI} bank supplies. For details on bank power supplies, see "Recommendation for Unused Bank Supplies" table in the *AC393: SmartFusion2 and IGLOO2 Board Design Guidelines Application Note*.
4. No Differential (that is to say, LVDS) I/Os or ODT attributes to be used.

Table 11 • SmartFusion2 and IGLOO2 Quiescent Supply Current (V_{DD} = 1.2 V) – Typical Process

Symbol	Modes	005	010	025	050	060	090	150	Unit	Conditions
IDC1	Non-Flash*Freeze	6.2	6.9	8.9	13.1	15.3	15.4	27.5	mA	Typical (T _J = 25 °C)
		24.0	28.4	40.6	67.8	80.6	81.4	144.7	mA	Commercial (T _J = 85 °C)
		35.2	41.9	60.5	102.1	121.4	122.6	219.1	mA	Industrial (T _J = 100 °C)

Table 11 • SmartFusion2 and IGLOO2 Quiescent Supply Current ($V_{DD} = 1.2\text{ V}$) – Typical Process

Symbol	Modes	005	010	025	050	060	090	150	Unit	Conditions
IDC2	Flash*Freeze	1.4	2.6	3.7	5.1	5.0	5.1	8.9	mA	Typical ($T_J = 25\text{ }^\circ\text{C}$)
		12.0	20.0	26.6	35.3	35.4	35.7	57.8	mA	Commercial ($T_J = 85\text{ }^\circ\text{C}$)
		18.5	30.8	41.0	54.5	54.5	55.0	89.0	mA	Industrial ($T_J = 100\text{ }^\circ\text{C}$)

Table 12 • SmartFusion2 and IGLOO2 Quiescent Supply Current ($V_{DD} = 1.26\text{ V}$) – Worst-Case Process

Symbol	Modes	005	010	025	050	060	090	150	Unit	Conditions
IDC1	Non-Flash*Freeze	43.8	57.0	84.6	132.3	161.4	163.0	242.5	mA	Commercial ($T_J = 85\text{ }^\circ\text{C}$)
		65.3	85.7	127.8	200.9	245.4	247.8	369.0	mA	Industrial ($T_J = 100\text{ }^\circ\text{C}$)
IDC2	Flash*Freeze	29.1	45.6	51.7	62.7	69.3	70.0	84.8	mA	Commercial ($T_J = 85\text{ }^\circ\text{C}$)
		44.9	70.3	79.7	96.5	106.8	107.8	130.6	mA	Industrial ($T_J = 100\text{ }^\circ\text{C}$)

2.3.2.2 Programming Currents

The following tables represent programming, verify and Inrush currents for SmartFusion2 SoC and IGLOO2 FPGA devices.

Table 13 • Currents During Program Cycle, $0\text{ }^\circ\text{C} \leq T_J \leq 85\text{ }^\circ\text{C}$ – Typical Process

Power Supplies	Voltage (V)	005	010	025	050	060	090	150 ¹	Unit
V_{DD}	1.26	46	53	55	58	30	42	52	mA
V_{PP}	3.46	8	11	6	10	9	12	12	mA
V_{PPNVM}	3.46	1	2	2	3	3	3		mA
V_{DDI}	2.62	31	16	17	1	12	12	81	mA
	3.46	62	31	36	1	12	17	84	mA
Number of banks		7	8	8	10	10	9	19	

1. V_{PP} and V_{PPNVM} are internally shorted.

Table 14 • Currents During Verify Cycle, $0\text{ }^\circ\text{C} \leq T_J \leq 85\text{ }^\circ\text{C}$ – Typical Process

Power Supplies	Voltage (V)	005	010	025	050	060	090	150 ¹	Unit
V_{DD}	1.26	44	53	55	58	33	41	51	mA
V_{PP}	3.46	6	5	3	15	8	11	12	mA
V_{PPNVM}	3.46	1	0	0	1	1	1		mA
V_{DDI}	2.62	31	16	17	1	12	11	81	mA
	3.46	61	32	36	1	12	17	84	mA
Number of banks		7	8	8	10	10	9	19	

1. V_{PP} and V_{PPNVM} are internally shorted.

Table 15 • Inrush Currents at Power up, $-40\text{ }^{\circ}\text{C} \leq T_J \leq 100\text{ }^{\circ}\text{C}$ – Typical Process

Power Supplies	Voltage (V)	005	010	025	050	060	090	150	Unit
V_{DD}	1.26	25	32	38	48	45	77	109	mA
V_{PP}	3.46	33	49	36	180	13	36	51	mA
V_{DDI}	2.62	134	141	161	187	93	272	388	mA
Number of banks		7	8	8	10	10	9	19	

2.3.3 Average Fabric Temperature and Voltage Derating Factors

The following table lists the average temperature and voltage derating factors for fabric timing delays normalized to $T_J = 85\text{ }^{\circ}\text{C}$, in worst-case $V_{DD} = 1.14\text{ V}$.

Table 16 • Average Junction Temperature and Voltage Derating Factors for Fabric Timing Delays

Array Voltage V_{DD} (V)	$-40\text{ }^{\circ}\text{C}$	$0\text{ }^{\circ}\text{C}$	$25\text{ }^{\circ}\text{C}$	$70\text{ }^{\circ}\text{C}$	$85\text{ }^{\circ}\text{C}$	$100\text{ }^{\circ}\text{C}$
1.14	0.83	0.89	0.92	0.98	1.00	1.02
1.2	0.75	0.80	0.83	0.89	0.91	0.93
1.26	0.69	0.73	0.76	0.81	0.83	0.85

2.3.4 Timing Model

This section describes timing model and timing parameters.

Figure 2 • Timing Model



The following table lists the timing model parameters in worst commercial-case conditions when $T_J = 85^\circ\text{C}$, $V_{DD} = 1.14\text{ V}$.

Table 17 • Timing Model Parameters

Index	Symbol	Description	-1	Unit	For More Information
A	T_{PY}	Propagation delay of DDR3 receiver	1.605	ns	See Table 137, page 50
B	T_{ICLKQ}	Clock-to-Q of the input data register	0.16	ns	See Table 221, page 71
		Setup time of the input data register	0.357	ns	See Table 221, page 71
C	T_{RCKH}	Input high delay for global clock	1.53	ns	See Table 227, page 78
		Input low delay for global clock	0.897	ns	See Table 227, page 78
D	T_{PY}	Input propagation delay of LVDS receiver	2.774	ns	See Table 167, page 56
E	T_{DP}	Propagation delay of a three-input AND gate	0.198	ns	See Table 223, page 76

Table 17 • Timing Model Parameters (continued)

Index	Symbol	Description	-1	Unit	For More Information
F	T_{DP}	Propagation delay of an OR gate	0.179	ns	See Table 223 , page 76
G	T_{DP}	Propagation delay of an LVDS transmitter	2.136	ns	See Table 169 , page 57
H	T_{DP}	Propagation delay of a three-input XOR Gate	0.241	ns	See Table 223 , page 76
I	T_{DP}	Propagation delay of LVCMOS 2.5 V transmitter, drive strength of 16 mA on the MSIO bank	2.412	ns	See Table 46 , page 27
J	T_{DP}	Propagation delay of a two-input NAND gate	0.179	ns	See Table 223 , page 76
K	T_{DP}	Propagation delay of LVCMOS 2.5 V transmitter, drive strength of 8 mA on the MSIO bank	2.309	ns	See Table 46 , page 27
L	T_{CLKQ}	Clock-to-Q of the data register	0.108	ns	See Table 224 , page 77
	T_{SUD}	Setup time of the data register	0.254	ns	See Table 224 , page 77
M	T_{DP}	Propagation delay of a two-input AND gate	0.179	ns	See Table 223 , page 76
N	T_{OCLKQ}	Clock-to-Q of the output data register	0.263	ns	See Table 220 , page 69
	T_{OSUD}	Setup time of the output data register	0.19	ns	See Table 220 , page 69
O	T_{DP}	Propagation delay of SSTL2, Class I transmitter on the MSIO bank	2.055	ns	See Table 114 , page 45
P	T_{DP}	Propagation delay of LVCMOS 1.5 V transmitter, drive strength of 12 mA, fast slew on the DDRIO bank	3.316	ns	See Table 70 , page 34

2.3.5 User I/O Characteristics

There are three types of I/Os supported in the IGLOO2 FPGA and SmartFusion2 SoC FPGA families: MSIO, MSIOD, and DDRIO I/O banks. The I/O standards supported by the different I/O banks is described in the I/Os section of the *UG0445: IGLOO2 FPGA and SmartFusion2 SoC FPGA Fabric User Guide*.

2.3.5.1 Input Buffer and AC Loading

The following figure shows the input buffer and AC loading.

Figure 3 • Input Buffer AC Loading



2.3.5.2 Output Buffer and AC Loading

The following figure shows the output buffer and AC loading.

Figure 4 • Output Buffer AC Loading



2.3.5.3 Tristate Buffer and AC Loading

The tristate path for enable path loadings is described in the respective specifications. The following figure shows the methodology of characterization illustrated by the enable path test point.

Figure 5 • Tristate Buffer for Enable Path Test Point



2.3.5.4 I/O Speeds

This section describes the maximum data rate summary of I/O in worst-case industrial conditions. See the individual I/O standards for operating conditions.

Table 18 • Maximum Data Rate Summary Table for Single-Ended I/O in Worst-Case Industrial Conditions

I/O	MSIO	MSIOD	DDRIO	Unit
PCI 3.3 V	630			Mbps
LVTTL 3.3 V	600			Mbps
LVC MOS 3.3 V	600			Mbps
LVC MOS 2.5 V	410	420	400	Mbps
LVC MOS 1.8 V	295	400	400	Mbps
LVC MOS 1.5 V	160	220	235	Mbps
LVC MOS 1.2 V	120	160	200	Mbps
LPDDR-LVC MOS 1.8 V mode			400	Mbps

Table 19 • Maximum Data Rate Summary Table for Voltage-Referenced I/O in Worst-Case Industrial Conditions

I/O	MSIO	MSIOD	DDRIO	Unit
LPDDR			400	Mbps
HSTL1.5 V			400	Mbps
SSTL 2.5 V	510	700	400	Mbps
SSTL 1.8 V			667	Mbps
SSTL 1.5 V			667	Mbps

Table 20 • Maximum Data Rate Summary Table for Differential I/O in Worst-Case Industrial Conditions

I/O	MSIO	MSIOD	Unit
LVPECL (input only)	900		Mbps
LVDS 3.3 V	535		Mbps
LVDS 2.5 V	535	700	Mbps
RSDS	520	700	Mbps
BLVDS	500		Mbps
MLVDS	500		Mbps
Mini-LVDS	520	700	Mbps

Table 21 • Maximum Frequency Summary Table for Single-Ended I/O in Worst-Case Industrial Conditions

I/O	MSIO	MSIOD	DDRIO	Unit
PCI 3.3 V	315			MHz
LVTTTL 3.3 V	300			MHz
LVC MOS 3.3 V	300			MHz
LVC MOS 2.5 V	205	210	200	MHz
LVC MOS 1.8 V	147.5	200	200	MHz
LVC MOS 1.5 V	80	110	118	MHz
LVC MOS 1.2 V	60	80	100	MHz
LPDDR– LVC MOS 1.8 V mode			200	MHz

Table 22 • Maximum Frequency Summary Table for Voltage-Referenced I/O in Worst-Case Industrial Conditions

I/O	MSIO	MSIOD	DDRIO	Unit
LPDDR			200	MHz
HSTL1.5 V			200	MHz
SSTL 2.5 V	255	350	200	MHz
SSTL 1.8 V			334	MHz
SSTL 1.5 V			334	MHz

Table 23 • Maximum Frequency Summary Table for Differential I/O in Worst-Case Industrial Conditions

I/O	MSIO	MSIOD	Unit
LVPECL (input only)	450		MHz
LVDS 3.3 V	267.5		MHz
LVDS 2.5 V	267.5	350	MHz
RSDS	260	350	MHz
BLVDS	250		MHz
MLVDS	250		MHz
Mini-LVDS	260	350	MHz

2.3.5.5 Detailed I/O Characteristics

Table 24 • Input Capacitance, Leakage Current, and Ramp Time

Symbol	Description	Maximum	Unit	Conditions
C_{IN}	Input capacitance	10	pF	
I_{IL} (dc)	Input current low (Applicable to HSTL/SSTL inputs only)	400	μ A	$V_{DDI} = 2.5$ V
		500	μ A	$V_{DDI} = 1.8$ V
		600	μ A	$V_{DDI} = 1.5$ V ¹
	Input current low (Applicable to all other digital inputs)	10	μ A	
I_{IH} (dc)	Input current high (Applicable to HSTL/SSTL inputs only)	400	μ A	$V_{DDI} = 2.5$ V
		500	μ A	$V_{DDI} = 1.8$ V
		600	μ A	$V_{DDI} = 1.5$ V ¹
	Input current high (Applicable to all other digital inputs)	10	μ A	
T_{RAMPIN} ²	Input ramp time (Applicable to all digital inputs)	50	ns	

1. Applicable when I/O pair is programmed with an HSTL/SSTL I/O type on IOP and an un-terminated I/O type (LVCMOS, for example) on ION pad.
2. Voltage ramp must be monotonic.

The following table lists the minimum and maximum I/O weak pull-up/pull-down resistance values of DDRIO I/O bank at V_{OH}/V_{OL} Level.

Table 25 • I/O Weak Pull-up/Pull-down Resistances for DDRIO I/O Bank

V_{DDI} Domain	R(WEAK PULL-UP) at V_{OH} (Ω)		R(WEAK PULL-DOWN) at V_{OL} (Ω)	
	Min	Max	Min	Max
2.5 V ^{1, 2}	10K	17.8K	9.98K	18K
1.8 V ^{1, 2}	10.3K	19.1K	10.3K	19.5K
1.5 V ^{1, 2}	10.6K	20.2K	10.6K	21.1K
1.2 V ^{1, 2}	11.1K	22.7K	11.2K	24.6K

1. $R(\text{WEAK PULL-DOWN}) = (V_{OLspec})/I(\text{WEAK PULL-DOWN MAX})$.
2. $R(\text{WEAK PULL-UP}) = (V_{DDImax} - V_{OHspec})/I(\text{WEAK PULL-UP MIN})$.

The following table lists the minimum and maximum I/O weak pull-up/pull-down resistance values of MSIO I/O bank at V_{OH}/V_{OL} Level.

Table 26 • I/O Weak Pull-Up/Pull-Down Resistances for MSIO I/O Bank

V_{DDI} Domain	R(WEAK PULL-UP) at V_{OH} (Ω)		R(WEAK PULL-DOWN) at V_{OL} (Ω)	
	Min	Max	Min	Max
3.3 V	9.9K	17.1K	9.98K	17.5K
2.5 V ^{1, 2}	10K	17.6K	10.1K	18.4K
1.8 V ^{1, 2}	10.4K	19.1K	10.4K	20.4K
1.5 V ^{1, 2}	10.7K	20.4K	10.8K	22.2K
1.2 V ^{1, 2}	11.3K	23.2K	11.5K	26.7K

1. $R(\text{WEAK PULL-DOWN}) = (V_{OLspec})/I(\text{WEAK PULL-DOWN MAX})$.
2. $R(\text{WEAK PULL-UP}) = (V_{DDI\max} - V_{OHspec})/I(\text{WEAK PULL-UP MIN})$.

The following table lists the minimum and maximum I/O weak pull-up/pull-down resistance values of MSIOD I/O bank at V_{OH}/V_{OL} Level.

Table 27 • I/O Weak Pull-up/Pull-down Resistances for MSIOD I/O Bank

V_{DDI} Domain	R(WEAK PULL-UP) at V_{OH} (Ω)		R(WEAK PULL-DOWN) at V_{OL} (Ω)	
	Min	Max	Min	Max
2.5 V ^{1, 2}	9.6K	16.6K	9.5K	16.4K
1.8 V ^{1, 2}	9.7K	17.3K	9.7K	17.1K
1.5 V ^{1, 2}	9.9K	18K	9.8K	17.6K
1.2 V ^{1, 2}	10.3K	19.6K	10K	19.1K

1. $R(\text{WEAK PULL-DOWN}) = (V_{OLspec})/I(\text{WEAK PULL-DOWN MAX})$.
2. $R(\text{WEAK PULL-UP}) = (V_{DDI\max} - V_{OHspec})/I(\text{WEAK PULL-UP MIN})$.

The following table lists the hysteresis voltage value for schmitt trigger mode input buffers.

Table 28 • Schmitt Trigger Input Hysteresis

Input Buffer Configuration	Hysteresis Value (Typical, unless otherwise noted)
3.3 V LVTTTL/LVCMOS/ PCI/PCI-X	$0.05 \times V_{DDI}$ (worst-case)
2.5 V LVCMOS	$0.05 \times V_{DDI}$ (worst-case)
1.8 V LVCMOS	$0.1 \times V_{DDI}$ (worst-case)
1.5 V LVCMOS	60 mV
1.2 V LVCMOS	20 mV

2.3.5.6 Single-Ended I/O Standards

2.3.5.6.1 Low Voltage Complementary Metal Oxide Semiconductor (LVCMOS)

LVCMOS is a widely used switching standard implemented in CMOS transistors. This standard is defined by JEDEC (JESD 8-5). The LVCMOS standards supported in IGLOO2 FPGAs and SmartFusion2 SoC FPGAs are: LVCMOS12, LVCMOS15, LVCMOS18, LVCMOS25, and LVCMOS33.

2.3.5.6.2 3.3 V LVCMOS/LVTTL

LVCMOS 3.3 V or Low-Voltage Transistor-Transistor Logic (LVTTL) is a general standard for 3.3 V applications.

Minimum and Maximum DC/AC Input and Output Levels Specification

Table 29 • LVTTL/LVCMOS 3.3 V DC Recommended DC Operating Conditions (Applicable to MSIO I/O Bank Only)

Parameter	Symbol	Min	Typ	Max	Unit
Supply voltage	V_{DDI}	3.15	3.3	3.45	V

Table 30 • LVTTL/LVCMOS 3.3 V Input Voltage Specification (Applicable to MSIO I/O Bank Only)

Parameter	Symbol	Min	Max	Unit
DC input logic high	V_{IH} (DC)	2.0	3.45	V
DC input logic low	V_{IL} (DC)	-0.3	0.8	V
Input current high ¹	I_{IH} (DC)			
Input current low ¹	I_{IL} (DC)			

1. See Table 24, page 22.

Table 31 • LVCMOS 3.3 V DC Output Voltage Specification (Applicable to MSIO I/O Bank Only)

Parameter	Symbol	Min	Max	Unit
DC output logic high ¹	V_{OH}	$V_{DDI} - 0.4$		V
DC output logic low ¹	V_{OL}		0.4	V

1. The V_{OH}/V_{OL} test points selected ensure compliance with LVCMOS 3.3 V JESD8-B requirements.

Table 32 • LVTTL 3.3 V DC Output Voltage Specification (Applicable to MSIO I/O Bank Only)

Parameter	Symbol	Min	Max	Unit
DC output logic high	V_{OH}	2.4		V
DC output logic low	V_{OL}		0.4	V

Table 33 • LVTTL/LVCMOS 3.3 V AC Maximum Switching Speed (Applicable to MSIO I/O Bank Only)

Parameter	Symbol	Max	Unit	Conditions
Maximum data rate (for MSIO I/O bank)	D_{MAX}	600	Mbps	AC loading: 17 pF load, maximum drive/slew

Table 34 • LVTTTL/LVCMOS 3.3 V AC Test Parameter Specifications (Applicable to MSIO I/O Bank Only)

Parameter	Symbol	Typ	Unit
Measuring/trip point for data path	V_{TRIP}	1.4	V
Resistance for enable path (T_{ZH} , T_{ZL} , T_{HZ} , T_{LZ})	R_{ENT}	2K	Ω
Capacitive loading for enable path (T_{ZH} , T_{ZL} , T_{HZ} , T_{LZ})	C_{ENT}	5	pF
Capacitive loading for data path (T_{DP})	C_{LOAD}	5	pF

Table 35 • LVTTTL/LVCMOS 3.3 V Transmitter Drive Strength Specifications for MSIO I/O Bank

Output Drive Selection	V_{OH} (V)	V_{OL} (V)	IOH (at V_{OH}) mA	IOL (at V_{OL}) mA
2 mA	$V_{DDI} - 0.4$	0.4	2	2
4 mA	$V_{DDI} - 0.4$	0.4	4	4
8 mA	$V_{DDI} - 0.4$	0.4	8	8
12 mA	$V_{DDI} - 0.4$	0.4	12	12
16 mA	$V_{DDI} - 0.4$	0.4	16	16
20 mA	$V_{DDI} - 0.4$	0.4	20	20

Note: For a detailed I/V curve, use the corresponding IBIS models:
www.microsemi.com/soc/download/ibis/default.aspx.

AC Switching Characteristics

Worst commercial-case conditions: $T_J = 85^\circ\text{C}$, $V_{DD} = 1.14\text{ V}$, $V_{DDI} = 3.0\text{ V}$

Table 36 • LVTTTL/LVCMOS 3.3 V Receiver Characteristics for MSIO I/O Bank (Input Buffers)

On-Die Termination (ODT)	T_{PY}		T_{PYS}		Unit
	-1	-Std	-1	-Std	
None	2.262	2.663	2.289	2.695	ns

Table 37 • LVTTTL/LVCMOS 3.3 V Transmitter Characteristics for MSIO I/O Bank (Output and Tristate Buffers)

Output Drive Selection	Slew Control	T_{DP}		T_{ZL}		T_{ZH}		T_{HZ}^1		T_{LZ}^1		Unit
		-1	-Std	-1	-Std	-1	-Std	-1	-Std	-1	-Std	
2 mA	Slow	3.192	3.755	3.47	4.083	2.969	3.494	1.856	2.183	3.337	3.926	ns
4 mA	Slow	2.331	2.742	2.673	3.145	2.526	2.973	3.034	3.569	4.451	5.236	ns
8 mA	Slow	2.135	2.511	2.33	2.741	2.297	2.703	4.532	5.331	4.825	5.676	ns
12 mA	Slow	2.052	2.414	2.107	2.479	2.162	2.544	5.75	6.764	5.445	6.406	ns
16 mA	Slow	2.062	2.425	2.072	2.438	2.145	2.525	5.993	7.05	5.625	6.618	ns
20 mA	Slow	2.148	2.527	1.999	2.353	2.088	2.458	6.262	7.367	5.876	6.913	ns

- Delay increases with drive strength are inherent to built-in slew control circuitry for simultaneous switching output (SSO) management.

2.3.5.7 2.5 V LVCMOS

LVCMOS 2.5 V is a general standard for 2.5 V applications and is supported in IGLOO2 FPGA and SmartFusion2 SoC FPGAs that are in compliance with the JEDEC specification JESD8-5A.

Minimum and Maximum DC/AC Input and Output Levels Specification

Table 38 • LVCMOS 2.5 V DC Recommended DC Operating Conditions

Parameter	Symbol	Min	Typ	Max	Unit
Supply voltage	V_{DDI}	2.375	2.5	2.625	V

Table 39 • LVCMOS 2.5 V DC Input Voltage Specification

Parameter	Symbol	Min	Max	Unit
DC input logic high (for MSIOD and DDRIO I/O banks)	V_{IH} (DC)	1.7	2.625	V
DC input logic high (for MSIO I/O bank)	V_{IH} (DC)	1.7	3.45	V
DC input logic low	V_{IL} (DC)	-0.3	0.7	V
Input current high ¹	I_{IH} (DC)			
Input current low ¹	I_{IL} (DC)			

1. See Table 24, page 22.

Table 40 • LVCMOS 2.5 V DC Output Voltage Specification

Parameter	Symbol	Min	Max	Unit
DC output logic high	V_{OH} ¹	$V_{DDI} - 0.4$	-	V
DC output logic low	V_{OL} ²		0.4	V

1. The VOH/VOL test points selected ensure compliance with LVCMOS 2.5 V JEDEC8-5A requirements.

Table 41 • LVCMOS 2.5 V AC Minimum and Maximum Switching Speed

Parameter	Symbol	Max	Unit	Conditions
Maximum data rate (for DDRIO I/O bank)	D_{MAX}	400	Mbps	AC loading: 17 pF load, maximum drive/slew
Maximum data rate (for MSIO I/O bank)	D_{MAX}	410	Mbps	AC loading: 17 pF load, maximum drive/slew
Maximum data rate (for MSIOD I/O bank)	D_{MAX}	420	Mbps	AC loading: 17 pF load, maximum drive/slew

Table 42 • LVCMOS 2.5 V AC Calibrated Impedance Option

Parameter	Symbol	Typ	Unit
Supported output driver calibrated impedance (for DDRIO I/O bank)	Rodt_cal	75, 60, 50, 33, 25, 20	Ω

Table 43 • LVCMOS 2.5 V AC Test Parameter Specifications

Parameter	Symbol	Typ	Unit
Measuring/trip point for data path	V_{TRIP}	1.2	V
Resistance for enable path (T_{ZH} , T_{ZL} , T_{HZ} , T_{LZ})	R_{ENT}	2K	$\Omega\sigma$
Capacitive loading for enable path (T_{ZH} , T_{ZL} , T_{HZ} , T_{LZ})	C_{ENT}	5	pF
Capacitive loading for data path (T_{DP})	C_{LOAD}	5	pF

Table 44 • LVCMOS 2.5 V Transmitter Drive Strength Specifications

Output Drive Selection			VOH (V)	VOL (V)	IOH (at VOH) mA	IOL (at VOL) mA
MSIO I/O Bank	MSIOD I/O Bank	DDRIO I/O Bank (With Software Default Fixed Code)	Min	Max		
			2 mA	2 mA	2 mA	$V_{DDI} - 0.4$
4 mA	4 mA	4 mA	$V_{DDI} - 0.4$	0.4	4	4
6 mA	6 mA	6 mA	$V_{DDI} - 0.4$	0.4	6	6
8 mA	8 mA	8 mA	$V_{DDI} - 0.4$	0.4	8	8
12 mA	12 mA	12 mA	$V_{DDI} - 0.4$	0.4	12	12
16 mA		16 mA	$V_{DDI} - 0.4$	0.4	16	16

Note: For board design considerations, output slew rates extraction, detailed output buffer resistances, and I/V Curve, use the corresponding IBIS models located at:
www.microsemi.com/soc/download/ibis/default.aspx.

AC Switching Characteristics

Worst commercial-case conditions: $T_J = 85^\circ\text{C}$, $V_{DD} = 1.14\text{ V}$, $V_{DDI} = 2.375\text{ V}$

Table 45 • LVCMOS 2.5 V Receiver Characteristics (Input Buffers)

	On-Die Termination (ODT)	T_{PY}		T_{PYS}		Unit
		-1	-Std	-1	-Std	
LVCMOS 2.5 V (for DDRIO I/O bank)	None	1.823	2.145	1.932	2.274	ns
LVCMOS 2.5 V (for MSIO I/O bank)	None	2.486	2.925	2.495	2.935	ns
LVCMOS 2.5 V (for MSIOD I/O bank)	None	2.29	2.694	2.305	2.712	ns

Table 46 • LVCMOS 2.5 V Transmitter Characteristics for DDRIO Bank (Output and Tristate Buffers)

Output Drive Selection	Slew Control	T_{DP}		T_{ZL}		T_{ZH}		T_{HZ}^1		T_{LZ}^1		Unit
		-1	-Std	-1	-Std	-1	-Std	-1	-Std	-1	-Std	
2 mA	Slow	3.657	4.302	3.393	3.991	3.675	4.323	3.894	4.582	3.552	4.18	ns
	Medium	3.374	3.97	3.139	3.693	3.396	3.995	3.635	4.277	3.253	3.828	ns
	Medium fast	3.239	3.811	3.036	3.572	3.261	3.836	3.519	4.141	3.128	3.681	ns
	Fast	3.224	3.793	3.029	3.563	3.246	3.818	3.512	4.132	3.119	3.67	ns

Table 46 • LVCMOS 2.5 V Transmitter Characteristics for DDRIO Bank (Output and Tristate Buffers)
(continued)

Output Drive Selection	Slew Control	T_{DP}		T_{ZL}		T_{ZH}		T_{HZ}^1		T_{LZ}^1		Unit
		-1	-Std	-1	-Std	-1	-Std	-1	-Std	-1	-Std	
4 mA	Slow	3.095	3.641	2.705	3.182	3.088	3.633	4.738	5.575	4.348	5.116	ns
	Medium	2.825	3.324	2.488	2.927	2.823	3.321	4.492	5.285	4.063	4.781	ns
	Medium fast	2.701	3.178	2.384	2.804	2.698	3.173	4.364	5.135	3.945	4.642	ns
	Fast	2.69	3.165	2.377	2.796	2.687	3.161	4.359	5.129	3.94	4.636	ns
6 mA	Slow	2.919	3.434	2.491	2.93	2.902	3.414	5.085	5.983	4.674	5.5	ns
	Medium	2.65	3.118	2.279	2.681	2.642	3.108	4.845	5.701	4.375	5.148	ns
	Medium fast	2.529	2.975	2.176	2.56	2.521	2.965	4.724	5.558	4.259	5.011	ns
	Fast	2.516	2.96	2.168	2.551	2.508	2.95	4.717	5.55	4.251	5.002	ns
8 mA	Slow	2.863	3.368	2.427	2.855	2.844	3.346	5.196	6.114	4.769	5.612	ns
	Medium	2.599	3.058	2.217	2.608	2.59	3.047	4.952	5.827	4.471	5.261	ns
	Medium fast	2.483	2.921	2.114	2.487	2.473	2.91	4.832	5.685	4.364	5.134	ns
	Fast	2.467	2.902	2.106	2.478	2.457	2.89	4.826	5.678	4.348	5.116	ns
12 mA	Slow	2.747	3.232	2.296	2.701	2.724	3.204	5.39	6.342	4.938	5.81	ns
	Medium	2.493	2.934	2.102	2.473	2.483	2.921	5.166	6.078	4.65	5.471	ns
	Medium fast	2.382	2.803	2.006	2.36	2.371	2.789	5.067	5.962	4.546	5.349	ns
	Fast	2.369	2.787	1.999	2.352	2.357	2.773	5.063	5.958	4.538	5.339	ns
16 mA	Slow	2.677	3.149	2.213	2.604	2.649	3.116	5.575	6.56	5.08	5.977	ns
	Medium	2.432	2.862	2.028	2.386	2.421	2.848	5.372	6.32	4.801	5.649	ns
	Medium fast	2.324	2.734	1.937	2.278	2.311	2.718	5.297	6.233	4.7	5.531	ns
	Fast	2.313	2.721	1.929	2.269	2.3	2.706	5.296	6.231	4.699	5.529	ns

1. Delay increases with drive strength are inherent to built-in slew control circuitry for simultaneous switching output (SSO) management.

Table 47 • LVCMOS 2.5 V Transmitter Characteristics for MSIO Bank (Output and Tristate Buffers)

Output Drive Selection	Slew Control	T_{DP}		T_{ZL}		T_{ZH}		T_{HZ}^1		T_{LZ}^1		Unit
		-1	-Std	-1	-Std	-1	-Std	-1	-Std	-1	-Std	
2 mA	Slow	3.48	4.095	3.855	4.534	3.785	4.453	2.12	2.494	3.45	4.059	ns
4 mA	Slow	2.583	3.039	3.042	3.579	3.138	3.691	4.143	4.874	4.687	5.513	ns
6 mA	Slow	2.392	2.815	2.669	3.139	2.82	3.317	4.909	5.775	5.083	5.98	ns
8 mA	Slow	2.309	2.717	2.565	3.017	2.74	3.223	5.812	6.837	5.523	6.497	ns
12 mA	Slow	2.333	2.745	2.437	2.867	2.626	3.089	6.131	7.213	5.712	6.72	ns
16 mA	Slow	2.412	2.838	2.335	2.747	2.533	2.979	6.54	7.694	6.007	7.067	ns

1. Delay increases with drive strength are inherent to built-in slew control circuitry for simultaneous switching output (SSO) management.

Table 48 • LVCMOS 2.5 V Transmitter Characteristics for MSIOD Bank (Output and Tristate Buffers)

Output Drive Selection	Slew Control	T_{DP}		T_{ZL}		T_{ZH}		T_{HZ}^1		T_{LZ}^1		Unit
		-1	-Std	-1	-Std	-1	-Std	-1	-Std	-1	-Std	
2 mA	Slow	2.206	2.596	2.678	3.15	2.64	3.106	4.935	5.805	4.74	5.576	ns
4 mA	Slow	1.835	2.159	2.242	2.637	2.256	2.654	5.413	6.368	5.15	6.059	ns
6 mA	Slow	1.709	2.01	2.132	2.508	2.167	2.549	5.813	6.838	5.499	6.469	ns
8 mA	Slow	1.63	1.918	1.958	2.303	2.012	2.367	6.226	7.324	5.816	6.842	ns
12 mA	Slow	1.648	1.939	1.86	2.187	1.921	2.259	6.519	7.669	6.027	7.09	ns

1. Delay increases with drive strength are inherent to built-in slew control circuitry for simultaneous switching output (SSO) management.

2.3.5.8 1.8 V LVCMOS

LVCMOS 1.8 is a general standard for 1.8 V applications and is supported in IGLOO2 FPGAs and SmartFusion2 SoC FPGAs in compliance to the JEDEC specification JESD8-7A.

Minimum and Maximum DC/AC Input and Output Levels Specification

Table 49 • LVCMOS 1.8 V DC Recommended Operating Conditions

Parameter	Symbol	Min	Typ	Max	Unit
LVCMOS 1.8 V DC Recommended Operating Conditions					
Supply voltage	V_{DDI}	1.710	1.8	1.89	V

Table 50 • LVCMOS 1.8 V DC Input Voltage Specification

Parameter	Symbol	Min	Max	Unit
DC input logic high (for MSIOD and DDRIO I/O banks)	V_{IH} (DC)	$0.65 \times V_{DDI}$	1.89	V
DC input logic high (for MSIO I/O bank)	V_{IH} (DC)	$0.65 \times V_{DDI}$	3.45	V
DC input logic low	V_{IL} (DC)	-0.3	$0.35 \times V_{DDI}$	V
Input current high ¹	I_{IH} (DC)			-
Input current low ¹	I_{IL} (DC)			-

1. See Table 24, page 22.

Table 51 • LVCMOS 1.8 V DC Output Voltage Specification

Parameter	Symbol	Min	Max	Unit
DC output logic high	V_{OH}	$V_{DDI} - 0.45$		V
DC output logic low	V_{OL}		0.45	V

Table 52 • LVCMOS 1.8 V Minimum and Maximum AC Switching Speed

Parameter	Symbol	Max	Unit	Conditions
Maximum data rate (for DDRIO I/O bank) ¹	D_{MAX}	400	Mbps	AC loading: 17 pF load, maximum drive/slew
Maximum data rate (for MSIO I/O bank)	D_{MAX}	295	Mbps	AC loading: 17 pF load, maximum drive/slew
Maximum data rate (for MSIOD I/O bank) ¹	D_{MAX}	400	Mbps	AC loading: 17 pF load, maximum drive/slew

1. Maximum Data Rate applies for Drive Strength 8 mA and above, All Slews.

Table 53 • LVCMOS 1.8 V AC Calibrated Impedance Option

Parameter	Symbol	Typ	Unit
Supported output driver calibrated impedance (for DDRIO I/O bank)	Rodt_cal	75, 60, 50, 33, 25, 20	Ω

Table 54 • LVCMOS 1.8 V AC Test Parameter Specifications

Parameter	Symbol	Typ	Unit
Measuring/trip point for data path	V _{TRIP}	0.9	V
Resistance for enable path (T _{ZH} , T _{ZL} , T _{HZ} , T _{LZ})	R _{ENT}	2k	Ω
Capacitive loading for enable path (T _{ZH} , T _{ZL} , T _{HZ} , T _{LZ})	C _{ENT}	5	pF
Capacitive loading for data path (T _{DP})	C _{LOAD}	5	pF

Table 55 • LVCMOS 1.8 V Transmitter Drive Strength Specifications

Output Drive Selection			V _{OH} (V)	V _{OL} (V)	IOH (at V _{OH})	IOL (at V _{OL})
MSIO I/O Bank	MSIOD I/O Bank	DDRIO I/O Bank	Min	Max	mA	mA
2 mA	2 mA	2 mA	V _{DDI} - 0.45	0.45	2	2
4 mA	4 mA	4 mA	V _{DDI} - 0.45	0.45	4	4
6 mA	6 mA	6 mA	V _{DDI} - 0.45	0.45	6	6
8 mA	8 mA	8 mA	V _{DDI} - 0.45	0.45	8	8
10 mA	10 mA	10 mA	V _{DDI} - 0.45	0.45	10	10
12 mA		12 mA	V _{DDI} - 0.45	0.45	12	12
		16 mA ¹	V _{DDI} - 0.45	0.45	16	16

1. 16 mA drive strengths, all slews, meets LPDDR JEDEC electrical compliance.

AC Switching Characteristics

Worst commercial-case conditions: T_J = 85 °C, V_{DD} = 1.14 V, V_{DDI} = 1.71 V

Table 56 • LVCMOS 1.8 V Receiver Characteristics (Input Buffers)

	On-Die Termination (ODT)	T _{Py}		T _{Pys}		Unit
		-1	-Std	-1	-Std	
LVCMOS 1.8 V (for DDRIO I/O bank with Fixed Codes)	None	1.968	2.315	2.099	2.47	ns
	None	2.898	3.411	2.883	3.393	ns
	50	3.05	3.59	3.044	3.583	ns
LVCMOS 1.8 V (for MSIO I/O bank)	75	2.999	3.53	2.987	3.516	ns
	150	2.947	3.469	2.933	3.452	ns
	None	2.611	3.071	2.598	3.057	ns
LVCMOS 1.8 V (for MSIOD I/O bank)	50	2.775	3.264	2.775	3.265	ns
	75	2.72	3.2	2.712	3.19	ns
	150	2.666	3.137	2.655	3.123	ns
	None	2.611	3.071	2.598	3.057	ns

Table 57 • LVCMOS 1.8 V Transmitter Characteristics for DDRIO I/O Bank with Fixed Code (Output and Tristate Buffers)

Output Drive Selection	Slew Control	T _{DP}		T _{ZL}		T _{ZH}		T _{HZ} ¹		T _{LZ} ¹		Unit
		-1	-Std	-1	-Std	-1	-Std	-1	-Std	-1	-Std	
2 mA	Slow	4.234	4.981	3.646	4.29	4.245	4.995	4.908	5.774	4.434	5.216	ns
	Medium	3.824	4.498	3.282	3.861	3.834	4.511	4.625	5.441	4.116	4.843	ns
	Medium fast	3.627	4.267	3.111	3.66	3.637	4.279	4.481	5.272	3.984	4.687	ns
	Fast	3.605	4.241	3.097	3.644	3.615	4.253	4.472	5.262	3.973	4.674	ns
4 mA	Slow	3.923	4.615	3.314	3.9	3.918	4.61	5.403	6.356	4.894	5.757	ns
	Medium	3.518	4.138	2.961	3.484	3.515	4.135	5.121	6.025	4.561	5.366	ns
	Medium fast	3.321	3.907	2.783	3.275	3.317	3.903	4.966	5.843	4.426	5.206	ns
	Fast	3.301	3.883	2.77	3.259	3.296	3.878	4.957	5.831	4.417	5.196	ns
6 mA	Slow	3.71	4.364	3.104	3.652	3.702	4.355	5.62	6.612	5.08	5.977	ns
	Medium	3.333	3.921	2.779	3.27	3.325	3.913	5.346	6.289	4.777	5.62	ns
	Medium fast	3.155	3.712	2.62	3.083	3.146	3.702	5.21	6.13	4.657	5.479	ns
	Fast	3.134	3.688	2.608	3.068	3.125	3.677	5.202	6.12	4.648	5.468	ns
8 mA	Slow	3.619	4.258	3.007	3.538	3.607	4.244	5.815	6.841	5.249	6.175	ns
	Medium	3.246	3.819	2.686	3.16	3.236	3.807	5.542	6.52	4.936	5.807	ns
	Medium fast	3.066	3.607	2.525	2.971	3.054	3.593	5.405	6.359	4.811	5.66	ns
	Fast	3.046	3.584	2.513	2.957	3.034	3.57	5.401	6.353	4.803	5.651	ns
10 mA	Slow	3.498	4.115	2.878	3.386	3.481	4.096	6.046	7.113	5.444	6.404	ns
	Medium	3.138	3.692	2.569	3.023	3.126	3.678	5.782	6.803	5.129	6.034	ns
	Medium fast	2.966	3.489	2.414	2.841	2.951	3.472	5.666	6.665	5.013	5.897	ns
	Fast	2.945	3.464	2.401	2.826	2.93	3.448	5.659	6.658	5.003	5.886	ns
12 mA	Slow	3.417	4.02	2.807	3.303	3.401	4.002	6.083	7.156	5.464	6.428	ns
	Medium	3.076	3.618	2.519	2.964	3.063	3.604	5.828	6.856	5.176	6.089	ns
	Medium fast	2.913	3.427	2.376	2.795	2.898	3.41	5.725	6.736	5.072	5.966	ns
	Fast	2.894	3.405	2.362	2.78	2.879	3.388	5.715	6.724	5.064	5.957	ns
16 mA	Slow	3.366	3.96	2.751	3.237	3.348	3.939	6.226	7.324	5.576	6.56	ns
	Medium	3.03	3.565	2.47	2.906	3.017	3.55	5.981	7.036	5.282	6.214	ns
	Medium fast	2.87	3.377	2.328	2.739	2.854	3.358	5.895	6.935	5.18	6.094	ns
	Fast	2.853	3.357	2.314	2.723	2.837	3.338	5.889	6.929	5.177	6.09	ns

1. Delay increases with drive strength are inherent to built-in slew control circuitry for simultaneous switching output (SSO) management.

Table 58 • LVCMOS 1.8 V Transmitter Characteristics for MSIO I/O Bank

Output Drive Selection	Slew Control	T_{DP}		T_{ZL}		T_{ZH}		T_{HZ}^1		T_{LZ}^1		Unit
		-1	-Std	-1	-Std	-1	-Std	-1	-Std	-1	-Std	
2 mA	Slow	3.441	4.047	4.165	4.9	4.413	5.192	4.891	5.755	5.138	6.044	ns
4 mA	Slow	3.218	3.786	3.642	4.284	3.941	4.636	5.665	6.665	5.568	6.551	ns
6 mA	Slow	3.141	3.694	3.501	4.118	3.823	4.498	6.587	7.75	6.032	7.096	ns
8 mA	Slow	3.165	3.723	3.319	3.904	3.654	4.298	6.898	8.115	6.216	7.313	ns
10 mA	Slow	3.202	3.767	3.278	3.857	3.616	4.254	7.25	8.529	6.435	7.571	ns
12 mA	Slow	3.277	3.855	3.175	3.736	3.519	4.139	7.392	8.697	6.538	7.692	ns

1. Delay increases with drive strength are inherent to built-in slew control circuitry for simultaneous switching output (SSO) management.

Table 59 • LVCMOS 1.8 V Transmitter Characteristics for MSIOD I/O Bank

Output Drive Selection	Slew Control	T_{DP}		T_{ZL}		T_{ZH}		T_{HZ}^1		T_{LZ}^1		Unit
		-1	-Std	-1	-Std	-1	-Std	-1	-Std	-1	-Std	
2 mA	Slow	2.725	3.206	3.316	3.901	3.484	4.099	5.204	6.123	4.997	5.88	ns
4 mA	Slow	2.242	2.638	2.777	3.267	2.947	3.466	5.729	6.74	5.448	6.41	ns
6 mA	Slow	1.995	2.347	2.466	2.901	2.63	3.094	6.372	7.496	5.987	7.043	ns
8 mA	Slow	2.001	2.354	2.44	2.87	2.6	3.058	6.633	7.804	6.193	7.286	ns
10 mA	Slow	2.025	2.382	2.312	2.719	2.47	2.906	6.94	8.165	6.412	7.544	ns

1. Delay increases with drive strength are inherent to built-in slew control circuitry for simultaneous switching output (SSO) management.

2.3.5.9 1.5 V LVCMOS

LVCMOS 1.5 is a general standard for 1.5 V applications and is supported in IGLOO2 FPGAs and SmartFusion2 SoC FPGAs in compliance to the JEDEC specification JESD8-11A.

Minimum and Maximum DC/AC Input and Output Levels Specification

Table 60 • LVCMOS 1.5 V DC Recommended Operating Conditions

Parameter	Symbol	Min	Typ	Max	Unit
Supply voltage	V_{DDI}	1.425	1.5	1.575	V

Table 61 • LVCMOS 1.5 V DC Input Voltage Specification

Parameter	Symbol	Min	Max	Unit
DC input logic high for (MSIOD and DDRIO I/O banks)	V_{IH} (DC)	$0.65 \times V_{DDI}$	1.575	V
DC input logic high (for MSIO I/O bank)	V_{IH} (DC)	$0.65 \times V_{DDI}$	3.45	V
DC input logic low	V_{IL} (DC)	-0.3	$0.35 \times V_{DDI}$	V
Input current high ¹	I_{IH} (DC)			-
Input current low ¹	I_{IL} (DC)			-

1. See Table 24, page 22.

Table 62 • LVCMOS 1.5 V DC Output Voltage Specification

Parameter	Symbol	Min	Max	Unit
DC output logic high	VOH	$V_{DDI} \times 0.75$		V
DC output logic low	VOL		$V_{DDI} \times 0.25$	V

Table 63 • LVCMOS 1.5 V AC Minimum and Maximum Switching Speed

Parameter	Symbol	Max	Unit	Conditions
Maximum data rate (for DDRIO I/O bank)	D_{MAX}	235	Mbps	AC loading: 17 pF load, maximum drive/slew
Maximum data rate (for MSIO I/O bank)	D_{MAX}	160	Mbps	AC loading: 17 pF load, maximum drive/slew
Maximum data rate (for MSIOD I/O bank)	D_{MAX}	220	Mbps	AC loading: 17 pF load, maximum drive/slew

Table 64 • LVCMOS 1.5 V AC Calibrated Impedance Option

Parameter	Symbol	Typ	Unit
Supported output driver calibrated impedance (for DDRIO I/O bank)	RODT_CA L	75, 60, 50, 40	Ω

Table 65 • LVCMOS 1.5 V AC Test Parameter Specifications

Parameter	Symbol	Typ	Unit
Measuring/trip point	V_{TRIP}	0.75	V
Resistance for enable path (T_{ZH} , T_{ZL} , T_{HZ} , T_{LZ})	R_{ENT}	2K	Ω
Capacitive loading for enable path (T_{ZH} , T_{ZL} , T_{HZ} , T_{LZ})	C_{ENT}	5	pF
Capacitive loading for data path (T_{DP})	C_{LOAD}	5	pF

Table 66 • LVCMOS 1.5 V Transmitter Drive Strength Specifications

Output Drive Selection			V_{OH} (V)	V_{OL} (V)	IOH (at V_{OH}) mA	IOL (at V_{OL}) mA
MSIO I/O Bank	MSIOD I/O Bank	DDRIO I/O Bank	Min	Max		
2 mA	2 mA	2 mA	$V_{DDI} \times 0.75$	$V_{DDI} \times 0.25$	2	2
4 mA	4 mA	4 mA	$V_{DDI} \times 0.75$	$V_{DDI} \times 0.25$	4	4
6 mA	6 mA	6 mA	$V_{DDI} \times 0.75$	$V_{DDI} \times 0.25$	6	6
8 mA		8 mA	$V_{DDI} \times 0.75$	$V_{DDI} \times 0.25$	8	8
		10 mA	$V_{DDI} \times 0.75$	$V_{DDI} \times 0.25$	10	10
		12 mA	$V_{DDI} \times 0.75$	$V_{DDI} \times 0.25$	12	12

Note: For a detailed I/V curve, use the corresponding IBIS models:

www.microsemi.com/soc/download/ibis/default.aspx.

AC Switching Characteristics

Worst commercial-case conditions: $T_J = 85\text{ }^\circ\text{C}$, $V_{DD} = 1.14\text{ V}$, $V_{DDI} = 1.425\text{ V}$

Table 67 • LVCMOS 1.5 V Receiver Characteristics for DDRIO I/O Bank with Fixed Codes (Input Buffers)

On-Die Termination (ODT)	T_{PY}		T_{PYS}		Unit
	-1	-Std	-1	-Std	
None	2.051	2.413	2.086	2.455	ns

Table 68 • LVCMOS 1.5 V Receiver Characteristics for MSIO I/O Bank (Input Buffers)

On-Die Termination (ODT)	T_{PY}		T_{PYS}		Unit
	-1	-Std	-1	-Std	
None	3.311	3.896	3.285	3.865	ns
50	3.654	4.299	3.623	4.263	ns
75	3.533	4.156	3.501	4.119	ns
150	3.415	4.018	3.388	3.986	ns

Table 69 • LVCMOS 1.5 V Receiver Characteristics for MSIOD I/O Bank (Input Buffers)

On-Die Termination (ODT)	T_{PY}		T_{PYS}		Unit
	-1	-Std	-1	-Std	
None	2.959	3.481	2.93	3.447	ns
50	3.298	3.88	3.268	3.845	ns
75	3.162	3.719	3.128	3.68	ns
150	3.053	3.592	3.021	3.554	ns

Table 70 • LVCMOS 1.5 V Transmitter Characteristics for DDRIO I/O Bank (Output and Tristate Buffers)

Output Drive Selection	Slew Control	T_{DP}		T_{ZL}		T_{ZH}		T_{HZ}^1		T_{LZ}^1		Unit
		-1	-Std	-1	-Std	-1	-Std	-1	-Std	-1	-Std	
2 mA	Slow	5.122	6.026	4.31	5.07	5.145	6.052	5.258	6.186	4.672	5.496	ns
	Medium	4.58	5.389	3.86	4.54	4.6	5.411	4.977	5.855	4.357	5.126	ns
	Medium fast	4.323	5.086	3.629	4.269	4.341	5.107	4.804	5.652	4.228	4.974	ns
	Fast	4.296	5.054	3.609	4.245	4.314	5.075	4.791	5.636	4.219	4.963	ns
4 mA	Slow	4.449	5.235	3.707	4.361	4.443	5.227	6.058	7.127	5.458	6.421	ns
	Medium	3.961	4.66	3.264	3.839	3.954	4.651	5.778	6.797	5.116	6.018	ns
	Medium fast	3.729	4.387	3.043	3.579	3.72	4.376	5.63	6.624	4.981	5.86	ns
	Fast	3.704	4.358	3.027	3.56	3.695	4.347	5.624	6.617	4.973	5.851	ns

Table 70 • LVCMOS 1.5 V Transmitter Characteristics for DDRIO I/O Bank (Output and Tristate Buffers)
(continued)

Output Drive Selection	Slew Control	T_{DP}		T_{ZL}		T_{ZH}		T_{HZ}^1		T_{LZ}^1		Unit
		-1	-Std	-1	-Std	-1	-Std	-1	-Std	-1	-Std	
6 mA	Slow	4.244	4.993	3.465	4.076	4.233	4.979	6.39	7.518	5.736	6.748	ns
	Medium	3.774	4.44	3.05	3.587	3.762	4.426	6.114	7.193	5.397	6.35	ns
	Medium fast	3.544	4.17	2.839	3.339	3.529	4.152	5.978	7.033	5.27	6.2	ns
	Fast	3.519	4.14	2.82	3.317	3.504	4.122	5.965	7.017	5.259	6.187	ns
8 mA	Slow	4.099	4.823	3.311	3.894	4.087	4.807	6.584	7.746	5.854	6.888	ns
	Medium	3.656	4.301	2.927	3.443	3.642	4.284	6.311	7.425	5.553	6.533	ns
	Medium fast	3.437	4.044	2.731	3.213	3.42	4.023	6.182	7.273	5.435	6.394	ns
	Fast	3.41	4.012	2.715	3.193	3.393	3.991	6.178	7.269	5.425	6.383	ns
10 mA	Slow	4.029	4.74	3.238	3.809	4.015	4.723	6.732	7.921	5.965	7.018	ns
	Medium	3.601	4.237	2.867	3.372	3.586	4.218	6.473	7.615	5.669	6.669	ns
	Medium fast	3.384	3.981	2.672	3.143	3.365	3.958	6.351	7.471	5.55	6.529	ns
	Fast	3.357	3.949	2.655	3.123	3.338	3.927	6.345	7.464	5.54	6.518	ns
12 mA	Slow	3.974	4.675	3.196	3.759	3.958	4.656	6.842	8.049	6.068	7.139	ns
	Medium	3.55	4.176	2.827	3.326	3.534	4.157	6.584	7.746	5.751	6.766	ns
	Medium fast	3.345	3.935	2.638	3.103	3.325	3.911	6.488	7.633	5.641	6.637	ns
	Fast	3.316	3.902	2.621	3.083	3.297	3.878	6.486	7.63	5.626	6.619	ns

1. Delay increases with drive strength are inherent to built-in slew control circuitry for simultaneous switching output (SSO) management.

Table 71 • LVCMOS 1.5 V Transmitter Characteristics for MSIO I/O Bank (Output and Tristate Buffers)

Output Drive Selection	Slew Control	T_{DP}		T_{ZL}		T_{ZH}		T_{HZ}^1		T_{LZ}^1		Unit
		-1	-Std	-1	-Std	-1	-Std	-1	-Std	-1	-Std	
2 mA	Slow	4.423	5.203	5.397	6.35	5.686	6.69	5.609	6.599	5.561	6.542	ns
4 mA	Slow	4.05	4.765	4.503	5.298	4.92	5.788	7.358	8.657	6.525	7.677	ns
6 mA	Slow	4.081	4.801	4.259	5.012	4.699	5.528	7.659	9.011	6.709	7.893	ns
8 mA	Slow	4.234	4.98	4.068	4.786	4.521	5.319	8.218	9.668	7.05	8.294	ns

1. Delay increases with drive strength are inherent to built-in slew control circuitry for simultaneous switching output (SSO) management.

Table 72 • LVCMOS 1.5 V Transmitter Characteristics for MSIOD I/O Bank (Output and Tristate Buffers)

Output Drive Selection	Slew Control	T_{DP}		T_{ZL}		T_{ZH}		T_{HZ}^1		T_{LZ}^1		Unit
		-1	-Std	-1	-Std	-1	-Std	-1	-Std	-1	-Std	
2 mA	Slow	2.735	3.218	3.371	3.966	3.618	4.257	6.03	7.095	5.705	6.712	ns
4 mA	Slow	2.426	2.854	2.992	3.521	3.221	3.79	6.738	7.927	6.298	7.41	ns
6 mA	Slow	2.433	2.862	2.81	3.306	3.031	3.566	7.123	8.38	6.596	7.76	ns

1. Delay increases with drive strength are inherent to built-in slew control circuitry for simultaneous switching output (SSO) management.

2.3.5.10 1.2 V LVCMOS

LVCMOS 1.2 is a general standard for 1.2 V applications and is supported in IGLOO2 FPGAs and SmartFusion2 SoC FPGAs in compliance to the JEDEC specification JESD8-12A.

Minimum and Maximum DC/AC Input and Output Levels Specification

Table 73 • LVCMOS 1.2 V DC Recommended DC Operating Conditions

Parameter	Symbol	Min	Typ	Max	Unit
Supply voltage	V_{DDI}	1.140	1.2	1.26	V

Table 74 • LVCMOS 1.2 V DC Input Voltage Specification

Parameter	Symbol	Min	Max	Unit
DC input logic high (for MSIOD and DDRIO I/O banks)	$V_{IH} (DC)$	$0.65 \times V_{DDI}$	1.26	V
DC input logic high (for MSIO I/O bank)	$V_{IH} (DC)$	$0.65 \times V_{DDI}$	3.45	V
DC input logic low	$V_{IL} (DC)$	-0.3	$0.35 \times V_{DDI}$	V
Input current high ¹	$I_{IH} (DC)$			
Input current low ¹	$I_{IL} (DC)$			

1. See [Table 24](#), page 22.

Table 75 • LVCMOS 1.2 V DC Output Voltage Specification

Parameter	Symbol	Min	Max	Unit
DC output logic high	V_{OH}	$V_{DDI} \times 0.75$		V
DC output logic low	V_{OL}		$V_{DDI} \times 0.25$	V

Table 76 • LVCMOS 1.2 V Minimum and Maximum AC Switching Speed

Parameter	Symbol	Max	Unit	Conditions
Maximum data rate (for DDRIO I/O bank)	D_{MAX}	200	Mbps	AC loading: 17 pF load, maximum drive/slew
Maximum data rate (for MSIO I/O bank)	D_{MAX}	120	Mbps	AC loading: 17 pF load, maximum drive/slew
Maximum data rate (for MSIOD I/O bank)	D_{MAX}	160	Mbps	AC loading: 17 pF load, maximum drive/slew

Table 77 • LVCMOS 1.2 V AC Calibrated Impedance Option

Parameter	Symbol	Typ	Unit
Supported output driver calibrated impedance (for DDRIO I/O bank)	RODT_CAL	75, 60, 50, 40	Ω

Table 78 • LVCMOS 1.2 V AC Test Parameter Specifications

Parameter	Symbol	Typ	Unit
Measuring/trip point	V_{TRIP}	0.6	V
Resistance for enable path (T_{ZH} , T_{ZL} , T_{HZ} , T_{LZ})	R_{ENT}	2K	Ω
Capacitive loading for enable path (T_{ZH} , T_{ZL} , T_{HZ} , T_{LZ})	C_{ENT}	5	pF
Capacitive loading for data path (T_{DP})	C_{LOAD}	5	pF

Table 79 • LVCMOS 1.2 V Transmitter Drive Strength Specifications

Output Drive Selection			V_{OH} (V)	V_{OL} (V)	IOH (at V_{OH}) mA	IOL (at V_{OL}) mA
MSIO I/O Bank	MSIOD I/O Bank	DDRIO I/O Bank	Min	Max		
2 mA	2 mA	2 mA	$V_{DDI} \times 0.75$	$V_{DDI} \times 0.25$	2	2
4 mA	4 mA	4 mA	$V_{DDI} \times 0.75$	$V_{DDI} \times 0.25$	4	4
		6 mA	$V_{DDI} \times 0.75$	$V_{DDI} \times 0.25$	6	6

Note: For a detailed I/V curve, use the corresponding IBIS models:
www.microsemi.com/soc/download/ibis/default.aspx.

AC Switching Characteristics

Worst commercial-case conditions: $T_J = 85^\circ\text{C}$, $V_{DD} = 1.14\text{ V}$, $V_{DDI} = 1.14\text{ V}$

Table 80 • LVCMOS 1.2 V Receiver Characteristics for DDRIO I/O Bank with Fixed Code (Input Buffers)

On-Die Termination (ODT)	T_{PY}		T_{PYS}		Unit
	-1	-Std	-1	-Std	
None	2.448	2.88	2.466	2.901	ns

Table 81 • LVCMOS 1.2 V Receiver Characteristics for MSIO I/O Bank (Input Buffers)

On-Die Termination ODT)	T_{PY}		T_{PYS}		Unit
	-1	-Std	-1	-Std	
None	4.714	5.545	4.675	5.5	ns
50	6.668	7.845	6.579	7.74	ns
75	5.832	6.862	5.76	6.777	ns
150	5.162	6.073	5.111	6.014	ns

Table 82 • LVCMOS 1.2 V Receiver Characteristics for MSIOD I/O Bank (Input Buffers)

On-Die Termination (ODT)	T_{PY}		T_{PYS}		Unit
	-1	-Std	-1	-Std	
None	4.154	4.887	4.114	4.84	ns
50	6.918	8.139	6.806	8.008	ns
75	5.613	6.603	5.533	6.509	ns
150	4.716	5.549	4.657	5.479	ns

Table 83 • LVCMOS 1.2 V Transmitter Characteristics for DDRIO I/O Bank (Output and Tristate Buffers)

Output Drive Selection	Slew Control	T_{DP}		T_{ZL}		T_{ZH}		T_{HZ}^1		T_{LZ}^1		Unit
		-1	-Std	-1	-Std	-1	-Std	-1	-Std	-1	-Std	
2 mA	Slow	6.713	7.897	5.362	6.308	6.723	7.909	7.233	8.51	6.375	7.499	ns
	Medium	5.912	6.955	4.616	5.43	5.915	6.959	6.887	8.102	6.009	7.069	ns
	Medium fast	5.5	6.469	4.231	4.978	5.5	6.471	6.672	7.849	5.835	6.865	ns
	Fast	5.462	6.426	4.194	4.935	5.463	6.427	6.646	7.819	5.828	6.857	ns
4 mA	Slow	6.109	7.186	4.708	5.539	6.098	7.174	8.005	9.418	7.033	8.274	ns
	Medium	5.355	6.299	4.034	4.746	5.338	6.28	7.637	8.985	6.672	7.849	ns
	Medium fast	4.953	5.826	3.685	4.336	4.932	5.802	7.44	8.752	6.499	7.646	ns
	Fast	4.911	5.777	3.658	4.303	4.89	5.754	7.427	8.737	6.488	7.632	ns
6 mA	Slow	5.89	6.929	4.506	5.301	5.874	6.911	8.337	9.808	7.315	8.605	ns
	Medium	5.176	6.089	3.862	4.543	5.155	6.065	7.986	9.394	6.943	8.168	ns
	Medium fast	4.792	5.637	3.523	4.145	4.765	5.606	7.808	9.186	6.775	7.97	ns
	Fast	4.754	5.593	3.486	4.101	4.728	5.563	7.777	9.149	6.769	7.963	ns

1. Delay increases with drive strength are inherent to built-in slew control circuitry for simultaneous switching output (SSO) management.

Table 84 • LVCMOS 1.2 V Transmitter Characteristics for MSIO I/O Bank (Output and Tristate Buffers)

Output Drive Selection	Slew Control	T_{DP}		T_{ZL}		T_{ZH}		T_{HZ}^1		T_{LZ}^1		Unit
		-1	-Std	-1	-Std	-1	-Std	-1	-Std	-1	-Std	
2 mA	Slow	6.746	7.937	7.458	8.774	8.172	9.614	9.867	11.608	8.393	9.874	ns
4 mA	Slow	7.068	8.315	6.678	7.857	7.474	8.793	10.986	12.924	9.043	10.638	ns

1. Delay increases with drive strength are inherent to built-in slew control circuitry for simultaneous switching output (SSO) management.

Table 85 • LVCMOS 1.2 V Transmitter Characteristics for MSIOD I/O Bank (Output and Tristate Buffers)

Output Drive Selection	Slew Control	T_{DP}		T_{ZL}		T_{ZH}		T_{HZ}^1		T_{LZ}^1		Unit
		-1	-Std	-1	-Std	-1	-Std	-1	-Std	-1	-Std	
2 mA	Slow	3.883	4.568	4.868	5.726	5.329	6.269	7.994	9.404	7.527	8.855	ns
4 mA	Slow	3.774	4.44	4.188	4.926	4.613	5.426	8.972	10.555	8.315	9.782	ns

1. Delay increases with drive strength are inherent to built-in slew control circuitry for simultaneous switching output (SSO) management.

2.3.5.11 3.3 V PCI/PCIX

Peripheral Component Interface (PCI) for 3.3 V standards specify support for 33 MHz and 66 MHz PCI bus applications.

Minimum and Maximum DC/AC Input and Output Levels Specification (Applicable to MSIO Bank Only)

Table 86 • PCI/PCI-X DC Recommended Operating Conditions

Parameter	Symbol	Min	Typ	Max	Unit
Supply voltage	V_{DDI}	3.15	3.3	3.45	V

Table 87 • PCI/PCI-X DC Input Voltage Specification

Parameter	Symbol	Min	Max	Unit
DC input voltage	V_I	0	3.45	V
Input current high ¹	$I_{IH}(DC)$			
Input current low ¹	$I_{IL}(DC)$			

1. See Table 24, page 22.

Table 88 • PCI/PCI-X DC Output Voltage Specification

Parameter	Symbol	Min	Typ	Max	Unit
DC output logic high	V_{OH}		Per PCI specification		V
DC output logic low	V_{OL}		Per PCI specification		V

Table 89 • PCI/PCI-X Minimum and Maximum AC Switching Speed

Parameter	Symbol	Max	Unit	Conditions
Maximum data rate (MSIO I/O bank)	D_{MAX}	630	Mbps	AC Loading: per JEDEC specifications

Table 90 • PCI/PCI-X AC Test Parameter Specifications

Parameter	Symbol	Typ	Unit
Measuring/trip point for data path (falling edge)	V_{TRIP}	$0.615 \times V_{DDI}$	V
Measuring/trip point for data path (rising edge)	V_{TRIP}	$0.285 \times V_{DDI}$	V
Resistance for data test path	R_{TT_TEST}	25	Ω
Resistance for enable path (T_{ZH} , T_{ZL} , T_{HZ} , T_{LZ})	R_{ENT}	2K	Ω
Capacitive loading for enable path (T_{ZH} , T_{ZL} , T_{HZ} , T_{LZ})	C_{ENT}	5	pF
Capacitive loading for data path (T_{DP})	C_{LOAD}	10	pF

AC Switching Characteristics

Worst commercial-case conditions: $T_J = 85\text{ }^\circ\text{C}$, $V_{DD} = 1.14\text{ V}$, $V_{DDI} = 3.0\text{ V}$

Table 91 • PCI/PCIX AC Switching Characteristics for Receiver for MSIO I/O Bank (Input Buffers)

On-Die Termination (ODT)	T_{PY}		T_{PYS}		Unit
	-1	-Std	-1	-Std	
None	2.229	2.623	2.238	2.633	ns

Table 92 • PCI/PCIX AC switching Characteristics for Transmitter for MSIO I/O Bank (Output and Tristate Buffers)

T_{DP}		T_{ZL}		T_{ZH}		T_{HZ}		T_{LZ}		Unit
-1	-Std	-1	-Std	-1	-Std	-1	-Std	-1	-Std	
2.146	2.525	2.043	2.404	2.084	2.452	6.095	7.171	5.558	6.539	ns

2.3.6 Memory Interface and Voltage Referenced I/O Standards

This section describes High-Speed Transceiver Logic (HSTL) memory interface and voltage reference I/O standards.

2.3.6.1 High-Speed Transceiver Logic (HSTL)

The HSTL standard is a general purpose high-speed bus standard sponsored by IBM (EIA/JESD8-6). IGLOO2 FPGA and SmartFusion2 SoC FPGA devices support two classes of the 1.5 V HSTL. These differential versions of the standard require a differential amplifier input buffer and a push-pull output buffer.

Minimum and Maximum DC/AC Input and Output Levels Specification (Applicable to DDRIO Bank Only)

Table 93 • HSTL Recommended DC Operating Conditions

Parameter	Symbol	Min	Typ	Max	Unit
Supply voltage	V_{DDI}	1.425	1.5	1.575	V
Termination voltage	V_{TT}	0.698	0.750	0.803	V
Input reference voltage	V_{REF}	0.698	0.750	0.803	V

Table 94 • HSTL DC Input Voltage Specification

Parameter	Symbol	Min	Max	Unit
DC input logic high	V_{IH} (DC)	$V_{REF} + 0.1$	1.575	V
DC input logic low	V_{IL} (DC)	-0.3	$V_{REF} - 0.1$	V
Input current high ¹	I_{IH} (DC)			
Input current low ¹	I_{IL} (DC)			

1. See Table 24, page 22.

Table 95 • HSTL DC Output Voltage Specification Applicable to DDRIO I/O Bank Only

Parameter	Symbol	Min	Max	Unit
HSTL Class I				
DC output logic high	V_{OH}	$V_{DDI} - 0.4$		V
DC output logic low	V_{OL}		0.4	V
Output minimum source DC current (MSIO and DDRIO I/O banks)	I_{OH} at V_{OH}	-8.0		mA
Output minimum sink current (MSIO and DDRIO I/O banks)	I_{OL} at V_{OL}	8.0		mA
HSTL Class II				
DC output logic high	V_{OH}	$V_{DDI} - 0.4$		V
DC output logic low	V_{OL}		0.4	V
Output minimum source DC current	I_{OH} at V_{OH}	-16.0		mA
Output minimum sink current	I_{OL} at V_{OL}	16.0		mA

Table 96 • HSTL DC Differential Voltage Specification

Parameter	Symbol	Min	Unit
DC input differential voltage	V_{ID} (DC)	0.2	V

Table 97 • HSTL AC Differential Voltage Specifications

Parameter	Symbol	Min	Max	Unit
AC input differential voltage	V_{DIFF}	0.4		V
AC differential cross point voltage	V_x	0.68	0.9	V

Table 98 • HSTL Minimum and Maximum AC Switching Speed

Parameter	Symbol	Max	Unit	Conditions
Maximum data rate	D_{MAX}	400	Mbps	AC loading: per JEDEC specifications

Table 99 • HSTL Impedance Specification

Parameter	Symbol	Typ	Unit	Conditions
Supported output driver calibrated impedance (for DDRIO I/O bank)	R_{REF}	25.5, 47.8	Ω	Reference resistance = 191 Ω
Effective impedance value (ODT for DDRIO I/O bank only)	R_{TT}	47.8	Ω	Reference resistance = 191 Ω

Table 100 • HSTL AC Test Parameter Specification

Parameter	Symbol	Typ	Unit
Measuring/trip point for data path	V_{TRIP}	0.75	V
Resistance for enable path (T_{ZH} , T_{ZL} , T_{HZ} , T_{LZ})	R_{ENT}	2K	Ω
Capacitive loading for enable path (T_{ZH} , T_{ZL} , T_{HZ} , T_{LZ})	C_{ENT}	5	pF
Reference resistance for data test path for HSTL15 Class I (T_{DP})	RTT_TEST	50	Ω
Reference resistance for data test path for HSTL15 Class II (T_{DP})	RTT_TEST	25	Ω
Capacitive loading for data path (T_{DP})	C_{LOAD}	5	pF

AC Switching Characteristics

Worst-case commercial conditions: $T_J = 85\text{ }^\circ\text{C}$, $V_{DD} = 1.14\text{ V}$, worst-case V_{DDI} .

Table 101 • HSTL Receiver Characteristics for DDRIO I/O Bank with Fixed Code (Input Buffers)

		T_{PY}		
On-Die Termination (ODT)		-1	-Std	Unit
Pseudo differential	None	1.605	1.888	ns
	47.8	1.614	1.898	ns
True differential	None	1.622	1.909	ns
	47.8	1.628	1.916	ns

Table 102 • HSTL Transmitter Characteristics for DDRIO I/O Bank (Output and Tristate Buffers)

	T_{DP}		T_{ZL}		T_{ZH}		T_{HZ}		T_{LZ}		Unit
	-1	-Std	-1	-Std	-1	-Std	-1	-Std	-1	-Std	
HSTL Class I											
Single-ended	2.6	3.059	2.514	2.958	2.514	2.958	2.431	2.86	2.431	2.86	ns
Differential	2.621	3.083	2.648	3.115	2.647	3.113	2.925	3.442	2.923	3.44	ns
HSTL Class II											
Single-ended	2.511	2.954	2.488	2.927	2.49	2.93	2.409	2.833	2.411	2.836	ns
Differential	2.528	2.974	2.552	3.003	2.551	3.001	2.897	3.409	2.896	3.408	ns

2.3.6.2 Stub-Series Terminated Logic

Stub-Series Terminated Logic (SSTL) for 2.5 V (SSTL2), 1.8 V (SSTL18), and 1.5 V (SSTL15) is supported in IGLOO2 and SmartFusion2 SoC FPGAs. SSTL2 is defined by JEDEC standard JESD8-9B and SSTL18 is defined by JEDEC standard JESD8-15. IGLOO2 SSTL I/O configurations are designed to meet double data rate standards DDR/2/3 for general purpose memory buses. Double data rate standards are designed to meet their JEDEC specifications as defined by JEDEC standard JESD79F for DDR, JEDEC standard JESD79-2F for DDR, JEDEC standard JESD79-3D for DDR3, and JEDEC standard JESD209A for LPDDR.

2.3.6.3 Stub-Series Terminated Logic 2.5 V (SSTL2)

SSTL2 Class I and Class II are supported in IGLOO2 and SmartFusion2 SoC FPGAs and also comply with reduced and full drive of double data rate (DDR) standards. IGLOO2 and SmartFusion2 SoC FPGA I/Os supports both standards for single-ended signaling and differential signaling for SSTL2. This standard requires a differential amplifier input buffer and a push-pull output buffer.

Minimum and Maximum DC/AC Input and Output Levels Specification

Table 103 • DDR1/SSTL2 DC Recommended Operating Conditions

Parameter	Symbol	Min	Typ	Max	Unit
Supply voltage	V_{DDI}	2.375	2.5	2.625	V
Termination voltage	V_{TT}	1.164	1.250	1.339	V
Input reference voltage	V_{REF}	1.164	1.250	1.339	V

Table 104 • DDR1/SSTL2 DC Input Voltage Specification

Parameter	Symbol	Min	Max	Unit
DC input logic high	V_{IH} (DC)	$V_{REF} + 0.15$	2.625	V
DC input logic low	V_{IL} (DC)	-0.3	$V_{REF} - 0.15$	V
Input current high ¹	I_{IH} (DC)			
Input current low ¹	I_{IL} (DC)			

1. See Table 24, page 22.

Table 105 • DDR1/SSTL2 DC Output Voltage Specification

Parameter	Symbol	Min	Max	Unit
SSTL2 Class I (DDR Reduced Drive)				
DC output logic high	V_{OH}	$V_{TT} + 0.608$		V
DC output logic low	V_{OL}		$V_{TT} - 0.608$	V
Output minimum source DC current	I_{OH} at V_{OH}	8.1		mA
Output minimum sink current	I_{OL} at V_{OL}	-8.1		mA
SSTL2 Class II (DDR Full Drive) – Applicable to MSIO and DDRIO I/O Bank Only				
DC output logic high	V_{OH}	$V_{TT} + 0.81$		V
DC output logic low	V_{OL}		$V_{TT} - 0.81$	V
Output minimum source DC current	I_{OH} at V_{OH}	16.2		mA
Output minimum sink current	I_{OL} at V_{OL}	-16.2		mA

Table 106 • DDR1/SSTL2 DC Differential Voltage Specification

Parameter	Symbol	Min	Unit
DC input differential voltage	V_{ID} (DC)	0.3	V

Table 107 • SSTL2 AC Differential Voltage Specifications

Parameter	Symbol	Min	Max	Unit
AC input differential voltage	$V_{DIFF} (AC)$	0.7		V
AC differential cross point voltage	$V_x (AC)$	$0.5 \times V_{DDI} - 0.2$	$0.5 \times V_{DDI} + 0.2$	V

Table 108 • SSTL2 Minimum and Maximum AC Switching Speeds

Parameter	Symbol	Max	Unit	Conditions
Maximum data rate (for DDRIO I/O bank)	D_{MAX}	400	Mbps	AC loading: per JEDEC specifications
Maximum data rate (for MSIO I/O bank)	D_{MAX}	575	Mbps	AC loading: 17pF load
Maximum data rate (for MSIOD I/O bank)	D_{MAX}	700	Mbps	AC loading: 3 pF / 50 Ω load
		510	Mbps	AC loading: 17pF load

Table 109 • SSTL2 AC Impedance Specifications

Parameter	Typ	Unit	Conditions
Supported output driver calibrated impedance (for DDRIO I/O bank)	20, 42	Ω	Reference resistor = 150 Ω

Table 110 • DDR1/SSTL2 AC Test Parameter Specifications

Parameter	Symbol	Typ	Unit
Measuring/trip point for data path	V_{TRIP}	1.25	V
Resistance for enable path (T_{ZH} , T_{ZL} , T_{HZ} , T_{LZ})	R_{ENT}	2K	Ω
Capacitive loading for enable path (T_{ZH} , T_{ZL} , T_{HZ} , T_{LZ})	C_{ENT}	5	pF
Reference resistance for data test path for SSTL2 Class I (T_{DP})	R_{TT_TEST}	50	Ω
Reference resistance for data test path for SSTL2 Class II (T_{DP})	R_{TT_TEST}	25	Ω
Capacitive loading for data path (T_{DP})	C_{LOAD}	5	pF

AC Switching Characteristics

Worst commercial-case conditions: $T_J = 85^\circ\text{C}$, $V_{DD} = 1.14\text{ V}$, $V_{DDI} = 2.375\text{ V}$

Table 111 • SSTL2 Receiver Characteristics for DDRIO I/O Bank (Input Buffers)

	On-Die Termination (ODT)	T_{PY}		Unit
		-1	-Std	
Pseudo differential	None	1.549	1.821	ns
True differential	None	1.589	1.87	ns

Table 112 • SSTL2 Receiver Characteristics for MSIO I/O Bank (Input Buffers)

	On-Die Termination (ODT)	T_{PY}		Unit
		-1	-Std	
Pseudo differential	None	2.798	3.293	ns
True differential	None	2.733	3.215	ns

Table 113 • DDR1/SSTL2 Receiver Characteristics for MSIOD I/O Bank (Input Buffers)

	On-Die Termination (ODT)	T_{PY}		Unit
		-1	-Std	
Pseudo differential	None	2.476	2.913	ns
True differential	None	2.475	2.911	ns

Table 114 • SSTL2 Class I Transmitter Characteristics for DDRIO I/O Bank (Output and Tristate Buffers)

	T_{DP}		T_{ZL}		T_{ZH}		T_{HZ}		T_{LZ}		Unit
	-1	-Std	-1	-Std	-1	-Std	-1	-Std	-1	-Std	
Single-ended	2.26	2.66	1.99	2.341	1.985	2.335	2.135	2.512	2.13	2.505	ns
Differential	2.26	2.658	2.202	2.591	2.201	2.589	2.393	2.815	2.392	2.814	ns

Table 115 • DDR1/SSTL2 Class I Transmitter Characteristics for MSIO I/O Bank (Output and Tristate Buffers)

	T_{DP}		T_{ZL}		T_{ZH}		T_{HZ}		T_{LZ}		Unit
	-1	-Std	-1	-Std	-1	-Std	-1	-Std	-1	-Std	
Single-ended	2.055	2.417	2.037	2.396	2.03	2.388	2.068	2.433	2.061	2.425	ns
Differential	2.192	2.58	2.434	2.864	2.425	2.852	2.164	2.545	2.156	2.536	ns

Table 116 • DDR1/SSTL2 Class I Transmitter Characteristics for MSIOD I/O Bank (Output and Tristate Buffers)

	T_{DP}		T_{ZL}		T_{ZH}		T_{HZ}		T_{LZ}		Unit
	-1	-Std	-1	-Std	-1	-Std	-1	-Std	-1	-Std	
Single-ended	1.512	1.779	1.462	1.72	1.462	1.72	1.676	1.972	1.676	1.971	ns
Differential	1.676	1.971	1.774	2.087	1.766	2.077	1.854	2.181	1.845	2.171	ns

Table 117 • DDR1/SSTL2 Class II Transmitter Characteristics for DDRIO I/O Bank (Output and Tristate Buffers)

	T_{DP}		T_{ZL}		T_{ZH}		T_{HZ}		T_{LZ}		Unit
	-1	-Std	-1	-Std	-1	-Std	-1	-Std	-1	-Std	
Single-ended	2.122	2.497	1.906	2.243	1.902	2.237	2.061	2.424	2.056	2.418	ns
Differential	2.127	2.501	2.042	2.402	2.043	2.403	2.363	2.78	2.365	2.781	ns

Table 118 • DDR1/SSTL2 Class II Transmitter Characteristics for MSIO I/O Bank (Output and Tristate Buffers)

	T_{DP}		T_{ZL}		T_{ZH}		T_{HZ}		T_{LZ}		Unit
	-1	-Std	-1	-Std	-1	-Std	-1	-Std	-1	-Std	
Single-ended	2.29	2.693	1.988	2.338	1.978	2.326	1.989	2.34	1.979	2.328	ns
Differential	2.418	2.846	2.304	2.711	2.297	2.702	2.131	2.506	2.124	2.499	ns

2.3.6.4 Stub-Series Terminated Logic 1.8 V (SSTL18)

SSTL18 Class I and Class II are supported in IGLOO2 and SmartFusion2 SoC FPGAs, and also comply with the reduced and full drive double data rate (DDR2) standard. IGLOO2 and SmartFusion2 SoC FPGA I/Os support both standards for single-ended signaling and differential signaling for SSTL18. This standard requires a differential amplifier input buffer and a push-pull output buffer.

Minimum and Maximum DC/AC Input and Output Levels Specification**Table 119 • SSTL18 DC Recommended DC Operating Conditions**

Parameter	Symbol	Min	Typ	Max	Unit
Supply voltage	V_{DDI}	1.71	1.8	1.89	V
Termination voltage	V_{TT}	0.838	0.900	0.964	V
Input reference voltage	V_{REF}	0.838	0.900	0.964	V

Table 120 • SSTL18 DC Input Voltage Specification

Parameter	Symbol	Min	Max	Unit
DC input logic high	V_{IH} (DC)	$V_{REF} + 0.125$	1.89	V
DC input logic low	V_{IL} (DC)	-0.3	$V_{REF} - 0.125$	V
Input current high ¹	I_{IH} (DC)			
Input current low ¹	I_{IL} (DC)			

1. See Table 24, page 22.

Table 121 • SSTL18 DC Output Voltage Specification

Parameter	Symbol	Min	Max	Unit
SSTL18 Class I (DDR2 Reduced Drive)				
DC output logic high	V_{OH}	$V_{TT} + 0.603$		V
DC output logic low	V_{OL}		$V_{TT} - 0.603$	V
Output minimum source DC current (DDRIO I/O bank only)	I_{OH} at V_{OH}	6.5		mA
Output minimum sink current (DDRIO I/O bank only)	I_{OL} at V_{OL}	-6.5		mA
SSTL18 Class II (DDR2 Full Drive)¹				
DC output logic high	V_{OH}	$V_{TT} + 0.603$		V
DC output logic low	V_{OL}		$V_{TT} - 0.603$	V
Output minimum source DC current (DDRIO I/O bank only)	I_{OH} at V_{OH}	13.4		mA
Output minimum sink current (DDRIO I/O bank only)	I_{OL} at V_{OL}	-13.4		mA

1. To meet JEDEC Electrical Compliance, use DDR2 Full Drive Transmitter.

Table 122 • SSTL18 DC Differential Voltage Specification

Parameter	Symbol	Min	Unit
DC input differential voltage	V_{ID} (DC)	0.3	V

Table 123 • SSTL18 AC Differential Voltage Specifications (Applicable to DDRIO Bank Only)

Parameter	Symbol	Min	Max	Unit
AC input differential voltage	V_{DIFF} (AC)	0.5		V
AC differential cross point voltage	V_x (AC)	$0.5 \times V_{DDI} - 0.175$	$0.5 \times V_{DDI} + 0.175$	V

Table 124 • SSTL18 Minimum and Maximum AC Switching Speed (Applicable to DDRIO Bank Only)

Parameter	Symbol	Max	Unit	Conditions
Maximum data rate (for DDRIO I/O bank)	D_{MAX}	667	Mbps	AC loading: per JEDEC specification

Table 125 • SSTL18 AC Impedance Specifications (Applicable to DDRIO Bank Only)

Parameter	Symbol	Typ	Unit	Conditions
Supported output driver calibrated impedance (for DDRIO I/O bank)	R_{REF}	20, 42	Ω	Reference resistor = 150 Ω
Effective impedance value (ODT)	R_{TT}	50, 75, 150	Ω	Reference resistor = 150 Ω

Table 126 • SSTL18 AC Test Parameter Specifications (Applicable to DDRIO Bank Only)

Parameter	Symbol	Typ	Unit
Measuring/trip point for data path	V_{TRIP}	0.9	V
Resistance for enable path (T_{ZH} , T_{ZL} , T_{HZ} , T_{LZ})	R_{ENT}	2K	Ω
Capacitive loading for enable path (T_{ZH} , T_{ZL} , T_{HZ} , T_{LZ})	C_{ENT}	5	pF
Reference resistance for data test path for SSTL18 Class I (T_{DIP})	R_{TT_TEST}	50	Ω
Reference resistance for data test path for SSTL18 Class II (T_{DIP})	R_{TT_TEST}	25	Ω
Capacitive loading for data path (T_{DIP})	C_{LOAD}	5	pF

AC Switching Characteristics

Worst commercial-case conditions: $T_J = 85^\circ\text{C}$, $V_{DD} = 1.14\text{ V}$, $V_{DDI} = 1.71\text{ V}$

Table 127 • DDR2/SSTL18 Receiver Characteristics for DDRIO I/O Bank with Fixed Code

	On-Die Termination (ODT)	T_{PY}		Unit
		-1	-Std	
Pseudo differential	None	1.567	1.844	ns
True differential	None	1.588	1.869	ns

Table 128 • DDR2/SSTL18 Transmitter Characteristics (Output and Tristate Buffers)

	T_{DP}		T_{ZL}		T_{ZH}		T_{HZ}		T_{LZ}		Unit
	-1	-Std	-1	-Std	-1	-Std	-1	-Std	-1	-Std	
SSTL18 Class I (for DDRIO I/O Bank)											
Single-ended	2.383	2.804	2.23	2.623	2.229	2.622	2.202	2.591	2.201	2.59	ns
Differential	2.413	2.84	2.797	3.29	2.797	3.29	2.282	2.685	2.282	2.685	ns
SSTL18 Class II (for DDRIO I/O Bank)											
Single-ended	2.281	2.683	2.196	2.584	2.195	2.583	2.171	2.555	2.17	2.554	ns
Differential	2.315	2.724	2.698	3.173	2.698	3.173	2.242	2.639	2.242	2.639	ns

2.3.6.5 Stub-Series Terminated Logic 1.5 V (SSTL15)

SSTL15 Class I and Class II are supported in IGLOO2 FPGAs and SmartFusion2 SoC FPGAs, and also comply with the reduced and full drive double data rate (DDR3) standard. IGLOO2 FPGA and SmartFusion2 SoC FPGA I/Os supports both standards for single-ended signaling and differential signaling for SSTL18. This standard requires a differential amplifier input buffer and a push-pull output buffer.

Minimum and Maximum DC/AC Input and Output Levels Specification

The following table lists the SSTL15 DC voltage specifications for DDRIO bank.

Table 129 • SSTL15 DC Recommended DC Operating Conditions (for DDRIO I/O Bank Only)

Parameter	Symbol	Min	Typ	Max	Unit
Supply voltage	V_{DDI}	1.425	1.5	1.575	V
Termination voltage	V_{TT}	0.698	0.750	0.803	V
Input reference voltage	V_{REF}	0.698	0.750	0.803	V

Table 130 • SSTL15 DC Input Voltage Specification (for DDRIO I/O Bank Only)

Parameter	Symbol	Min	Max	Unit
DC input logic high	$V_{IH}(DC)$	$V_{REF} + 0.1$	1.575	V
DC input logic low	$V_{IL}(DC)$	-0.3	$V_{REF} - 0.1$	V
Input current high ¹	$I_{IH}(DC)$			
Input current low ¹	$I_{IL}(DC)$			

1. See Table 24, page 22.

Table 131 • SSTL15 DC Output Voltage Specification (for DDRIO I/O Bank Only)

Parameter	Symbol	Min	Max	Unit
DDR3/SSTL15 Class I (DDR3 Reduced Drive)				
DC output logic high	V_{OH}	$0.8 \times V_{DDI}$		V
DC output logic low	V_{OL}		$0.2 \times V_{DDI}$	V
Output minimum source DC current	I_{OH} at V_{OH}	6.5		mA
Output minimum sink current	I_{OL} at V_{OL}	-6.5		mA
DDR3/SSTL15 Class II (DDR3 Full Drive)				
DC output logic high	V_{OH}	$0.8 \times V_{DDI}$		V
DC output logic low	V_{OL}		$0.2 \times V_{DDI}$	V
Output minimum source DC current	I_{OH} at V_{OH}	7.6		mA
Output minimum sink current	I_{OL} at V_{OL}	-7.6		mA

Table 132 • SSTL15 DC Differential Voltage Specification (for DDRIO I/O Bank Only)

Parameter	Symbol	Min	Unit
DC input differential voltage	V_{ID}	0.2	V

Note: To meet JEDEC electrical compliance, use DDR3 full drive transmitter.

Table 133 • SSTL15 AC SSTL15 Minimum and Maximum AC Switching Speed (for DDRIO I/O Bank Only)

Parameter	Symbol	Min	Max	Unit
AC input differential voltage	V_{DIFF} (AC)	0.3		V
AC differential cross point voltage	V_x (AC)	$0.5 \times V_{DDI} - 0.150$	$0.5 \times V_{DDI} + 0.150$	V

Table 134 • SSTL15 Minimum and Maximum AC Switching Speed (for DDRIO I/O Bank Only)

Parameter	Symbol	Max	Unit	Conditions
Maximum data rate	D_{MAX}	667	Mbps	AC loading: per JEDEC specifications

Table 135 • SSTL15 AC Calibrated Impedance Option (for DDRIO I/O Bank Only)

Parameter	Symbol	Typ	Unit	Conditions
Supported output driver calibrated impedance	R_{REF}	34, 40	Ω	Reference resistor = 240 Ω
Effective impedance value (ODT)	R_{TT}	20, 30, 40, 60, 120	Ω	Reference resistor = 240 Ω

Table 136 • SSTL15 AC Test Parameter Specifications (for DDRIO I/O Bank Only)

Parameter	Symbol	Typ	Unit
Measuring/trip point for data path	V_{TRIP}	0.75	V
Resistance for enable path (T_{ZH} , T_{ZL} , T_{HZ} , T_{LZ})	R_{ENT}	2K	Ω
Capacitive loading for enable path (T_{ZH} , T_{ZL} , T_{HZ} , T_{LZ})	C_{ENT}	5	pF
Reference resistance for data test path for SSTL15 Class I (T_{DP})	R_{TT_TEST}	50	Ω
Reference resistance for data test path for SSTL15 Class II (T_{DP})	R_{TT_TEST}	25	Ω
Capacitive loading for data path (T_{DP})	C_{LOAD}	5	pF

AC Switching Characteristics

Worst commercial-case conditions: $T_J = 85\text{ }^\circ\text{C}$, $V_{DD} = 1.14\text{ V}$, $V_{DDI} = 1.425\text{ V}$

Table 137 • DDR3/SSTL15 Receiver Characteristics for DDRIO I/O Bank – with Calibration Only

	On-Die Termination (ODT)	T_{PY}		Unit
		-1	-Std	
Pseudo differential	None	1.605	1.888	ns
	20	1.616	1.901	ns
	30	1.613	1.897	ns
	40	1.611	1.895	ns
	60	1.609	1.893	ns
	120	1.607	1.89	ns
True differential	None	1.623	1.91	ns
	20	1.637	1.926	ns
	30	1.63	1.918	ns
	40	1.626	1.914	ns
	60	1.622	1.91	ns
	120	1.619	1.905	ns

Table 138 • DDR3/SSTL15 Transmitter Characteristics (Output and Tristate Buffers)

	T_{DP}		T_{ZL}		T_{ZH}		T_{HZ}		T_{LZ}		Unit
	-1	-Std	-1	-Std	-1	-Std	-1	-Std	-1	-Std	
DDR3 Reduced Drive/SSTL15 Class I (for DDRIO I/O Bank)											
Single-ended	2.533	2.98	2.522	2.967	2.523	2.968	2.427	2.855	2.428	2.856	ns
Differential	2.555	3.005	3.073	3.615	3.073	3.615	2.416	2.843	2.416	2.843	ns
DDR3 Full Drive/SSTL15 Class II (for DDRIO I/O Bank)											
Single-ended	2.53	2.977	2.514	2.958	2.516	2.96	2.422	2.849	2.425	2.852	ns
Differential	2.552	3.002	2.591	3.048	2.59	3.047	2.882	3.391	2.881	3.39	ns

2.3.6.6 Low Power Double Data Rate (LPDDR)

LPDDR reduced and full drive low power double data rate standards are supported in IGLOO2 FPGA and SmartFusion2 SoC FPGA I/Os. This standard requires a differential amplifier input buffer and a push-pull output buffer.

Minimum and Maximum DC/AC Input and Output Levels Specification

Table 139 • LPDDR DC Recommended DC Operating Conditions

Parameter	Symbol	Min	Typ	Max
Supply voltage	V_{DDI}	1.71	1.8	1.89
Termination voltage	V_{TT}	0.838	0.900	0.964
Input reference voltage	V_{REF}	0.838	0.900	0.964

Table 140 • LPDDR DC Input Voltage Specification

Parameter	Symbol	Min	Max
DC input logic high	V_{IH} (DC)	$0.7 \times V_{DDI}$	1.89
DC input logic low	V_{IL} (DC)	-0.3	$0.3 \times V_{DDI}$
Input current high ¹	I_{IH} (DC)		
Input current low ¹	I_{IL} (DC)		

1. See Table 24, page 22.

Table 141 • LPDDR DC Output Voltage Specification Reduced Drive

Parameter	Symbol	Min	Max
DC output logic high	V_{OH}	$0.9 \times V_{DDI}$	
DC output logic low	V_{OL}		$0.1 \times V_{DDI}$
Output minimum source DC current	I_{OH} at V_{OH}	0.1	
Output minimum sink current	I_{OL} at V_{OL}	-0.1	

Table 142 • LPDDR DC Output Voltage Specification Full Drive¹

Parameter	Symbol	Min	Max
DC output logic high	V_{OH}	$0.9 \times V_{DDI}$	
DC output logic low	V_{OL}		$0.1 \times V_{DDI}$
Output minimum source DC current	I_{OH} at V_{OH}	0.1	
Output minimum sink current	I_{OL} at V_{OL}	-0.1	

1. To meet JEDEC Electrical Compliance, use LPDDR Full Drive Transmitter.

Table 143 • LPDDR DC Differential Voltage Specification

Parameter	Symbol	Min
DC input differential voltage	V_{ID} (DC)	$0.4 \times V_{DDI}$

Table 144 • LPDDR AC Differential Voltage Specifications (for DDRIO I/O Bank Only)

Parameter	Symbol	Min	Max	Unit
AC input differential voltage	V_{DIFF}	$0.6 \times V_{DDI}$		V
AC differential cross point voltage	V_x	$0.4 \times V_{DDI}$	$0.6 \times V_{DDI}$	V

Table 145 • LPDDR AC Specifications (for DDRIO I/O Bank Only)

Parameter	Symbol	Max	Unit	Conditions
Maximum data rate	D_{MAX}	400	Mbps	AC loading: per JEDEC specifications

Table 146 • LPDDR AC Calibrated Impedance Option (for DDRIO I/O Bank Only)

Parameter	Symbol	Typ	Unit	Conditions
Supported output driver calibrated impedance	R_{REF}	20, 42	Ω	Reference resistor = 150 Ω
Effective impedance value (ODT)	R_{TT}	50, 70, 150	Ω	Reference resistor = 150 Ω

Table 147 • LPDDR AC Test Parameter Specifications (for DDRIO I/O Bank Only)

Parameter	Symbol	Typ	Unit
Measuring/trip point for data path	V_{TRIP}	0.9	V
Resistance for enable path (T_{ZH} , T_{ZL} , T_{HZ} , T_{LZ})	R_{ENT}	2K	Ω
Capacitive loading for enable path (T_{ZH} , T_{ZL} , T_{HZ} , T_{LZ})	C_{ENT}	5	pF
Reference resistance for data test path for LPDDR (T_{DP})	R_{TT_TEST}	50	Ω
Capacitive loading for data path (T_{DP})	C_{LOAD}	5	Ω

AC Switching Characteristics

Worst-case commercial conditions: $T_J = 85^\circ\text{C}$, $V_{DD} = 1.14\text{ V}$, worst-case V_{DDI} .

Table 148 • LPDDR Receiver Characteristics for DDRIO I/O Bank with Fixed Codes

		T_{PY}		Unit
		On-Die Termination (ODT) -1	-Std	
Pseudo differential	None	1.568	1.845	ns
True differential	None	1.588	1.869	ns

Table 149 • LPDDR Reduced Drive for DDRIO I/O Bank (Output and Tristate Buffers)

	T_{DP}		T_{ENZL}		T_{ENZH}		T_{ENHZ}		T_{ENLZ}		Unit
	-1	-Std	-1	-Std	-1	-Std	-1	-Std	-1	-Std	
Single-ended	2.383	2.804	2.23	2.623	2.229	2.622	2.202	2.591	2.201	2.59	ns
Differential	2.396	2.819	2.764	3.252	2.764	3.252	2.255	2.653	2.255	2.653	ns

Table 150 • LPDDR Full Drive for DDRIO I/O Bank (Output and Tristate Buffers)

	T_{DP}		T_{ENZL}		T_{ENZH}		T_{ENHZ}		T_{ENLZ}		Unit
	-1	-Std	-1	-Std	-1	-Std	-1	-Std	-1	-Std	
Single-ended	2.281	2.683	2.196	2.584	2.195	2.583	2.171	2.555	2.17	2.554	ns
Differential	2.298	2.703	2.288	2.692	2.288	2.692	2.593	3.051	2.593	3.051	ns

Minimum and Maximum DC/AC Input and Output Levels Specification using LPDDR-LVCMOS 1.8 V Mode

Table 151 • LPDDR-LVCMOS 1.8 V Mode Recommended DC Operating Conditions

Parameter	Symbol	Min	Typ	Max	Unit
Supply voltage	V_{DDI}	1.710	1.8	1.89	V

Table 152 • LPDDR-LVCMOS 1.8 V Mode DC Input Voltage Specification

Parameter	Symbol	Min	Max	Unit
DC input logic high (for MSIOD and DDRIO I/O banks)	V_{IH} (DC)	$0.65 \times V_{DDI}$	1.89	V
DC input logic high (for MSIO I/O bank)	V_{IH} (DC)	$0.65 \times V_{DDI}$	3.45	V
DC input logic low	V_{IL} (DC)	-0.3	$0.35 \times V_{DDI}$	V
Input current high ¹	I_{IH} (DC)			
Input current low ¹	I_{IL} (DC)			

1. See Table 24, page 22.

Table 153 • LPDDR-LVCMOS 1.8 V Mode DC Output Voltage Specification

Parameter	Symbol	Min	Max	Unit
DC output logic high	V_{OH}	$V_{DDI} - 0.45$		V
DC output logic low	V_{OL}		0.45	V

Table 154 • LPDDR-LVCMOS 1.8 V Minimum and Maximum AC Switching Speeds

Parameter	Symbol	Max	Unit	Conditions
Maximum data rate (for DDRIO I/O bank)	D_{MAX}	400	Mbps	AC loading: 17pf load, 8 ma drive and above/all slew

Table 155 • LPDDR-LVCMOS 1.8 V Calibrated Impedance Option

Parameter	Symbol	Typ	Unit
Supported output driver calibrated impedance (for DDRIO I/O bank)	RODT_CAL	75, 60, 50, 33, 25, 20	Ω

Table 156 • LPDDR-LVCMOS 1.8 V AC Test Parameter Specifications

Parameter	Symbol	Typ	Unit
Measuring/trip point for data path	V_{TRIP}	0.9	V
Resistance for enable path (T_{ZH} , T_{ZL} , T_{HZ} , T_{LZ})	R_{ENT}	2K	Ω
Capacitive loading for enable path (T_{ZH} , T_{ZL} , T_{HZ} , T_{LZ})	C_{ENT}	5	pF
Capacitive loading for data path (T_{DP})	C_{LOAD}	5	pF

Table 157 • LPDDR-LVCMOS 1.8 V Mode Transmitter Drive Strength Specification for DDRIO Bank

Output Drive Selection	V_{OH} (V) Min	V_{OL} (V) Max	I_{OH} (at V_{OH}) mA	I_{OL} (at V_{OL}) mA
2 mA	$V_{DDI} - 0.45$	0.45	2	2
4 mA	$V_{DDI} - 0.45$	0.45	4	4
6 mA	$V_{DDI} - 0.45$	0.45	6	6
8 mA	$V_{DDI} - 0.45$	0.45	8	8
10 mA	$V_{DDI} - 0.45$	0.45	10	10
12 mA	$V_{DDI} - 0.45$	0.45	12	12
16 mA ¹	$V_{DDI} - 0.45$	0.45	16	16

1. 16 mA Drive Strengths, All Slews, meet LPDDR JEDEC electrical compliance.

Table 158 • LPDDR-LVCMOS 1.8V AC Switching Characteristics for Receiver (for DDRIO I/O Bank with Fixed Code - Input Buffers)

ODT (On Die Termination)	-1	-Std	-1	-Std	Unit
None	1.968	2.315	2.099	2.47	ns

Table 159 • LPDDR-LVCMOS 1.8 V AC Switching Characteristics for Transmitter for DDRIO I/O Bank (Output and Tristate Buffers)

Output Drive Selection	Slew Control	T_{DP}		T_{ZL}		T_{ZH}		T_{HZ}^1		T_{LZ}^1		Unit
		-1	-Std	-1	-Std	-1	-Std	-1	-Std	-1	-Std	
2 mA	slow	4.234	4.981	3.646	4.29	4.245	4.995	4.908	5.774	4.434	5.216	ns
	medium	3.824	4.498	3.282	3.861	3.834	4.511	4.625	5.441	4.116	4.843	ns
	medium_fast	3.627	4.267	3.111	3.66	3.637	4.279	4.481	5.272	3.984	4.687	ns
	fast	3.605	4.241	3.097	3.644	3.615	4.253	4.472	5.262	3.973	4.674	ns
4 mA	slow	3.923	4.615	3.314	3.9	3.918	4.61	5.403	6.356	4.894	5.757	ns
	medium	3.518	4.138	2.961	3.484	3.515	4.135	5.121	6.025	4.561	5.366	ns
	medium_fast	3.321	3.907	2.783	3.275	3.317	3.903	4.966	5.843	4.426	5.206	ns
	fast	3.301	3.883	2.77	3.259	3.296	3.878	4.957	5.831	4.417	5.196	ns
6 mA	slow	3.71	4.364	3.104	3.652	3.702	4.355	5.62	6.612	5.08	5.977	ns
	medium	3.333	3.921	2.779	3.27	3.325	3.913	5.346	6.289	4.777	5.62	ns
	medium_fast	3.155	3.712	2.62	3.083	3.146	3.702	5.21	6.13	4.657	5.479	ns
	fast	3.134	3.688	2.608	3.068	3.125	3.677	5.202	6.12	4.648	5.468	ns
8 mA	slow	3.619	4.258	3.007	3.538	3.607	4.244	5.815	6.841	5.249	6.175	ns

Table 159 • LPDDR-LVCMOS 1.8 V AC Switching Characteristics for Transmitter for DDRIO I/O Bank (Output and Tristate Buffers) (continued)

	medium	3.246	3.819	2.686	3.16	3.236	3.807	5.542	6.52	4.936	5.807	ns
	medium_fast	3.066	3.607	2.525	2.971	3.054	3.593	5.405	6.359	4.811	5.66	ns
	fast	3.046	3.584	2.513	2.957	3.034	3.57	5.401	6.353	4.803	5.651	ns
10 mA	slow	3.498	4.115	2.878	3.386	3.481	4.096	6.046	7.113	5.444	6.404	ns
	medium	3.138	3.692	2.569	3.023	3.126	3.678	5.782	6.803	5.129	6.034	ns
	medium_fast	2.966	3.489	2.414	2.841	2.951	3.472	5.666	6.665	5.013	5.897	ns
	fast	2.945	3.464	2.401	2.826	2.93	3.448	5.659	6.658	5.003	5.886	ns
12 mA	slow	3.417	4.02	2.807	3.303	3.401	4.002	6.083	7.156	5.464	6.428	ns
	medium	3.076	3.618	2.519	2.964	3.063	3.604	5.828	6.856	5.176	6.089	ns
	medium_fast	2.913	3.427	2.376	2.795	2.898	3.41	5.725	6.736	5.072	5.966	ns
	fast	2.894	3.405	2.362	2.78	2.879	3.388	5.715	6.724	5.064	5.957	ns
16 mA	slow	3.366	3.96	2.751	3.237	3.348	3.939	6.226	7.324	5.576	6.56	ns
	medium	3.03	3.565	2.47	2.906	3.017	3.55	5.981	7.036	5.282	6.214	ns
	medium_fast	2.87	3.377	2.328	2.739	2.854	3.358	5.895	6.935	5.18	6.094	ns
	fast	2.853	3.357	2.314	2.723	2.837	3.338	5.889	6.929	5.177	6.09	ns

1. Delay increases with drive strength are inherent to built-in slew control circuitry for simultaneous switching output (SSO management).

2.3.7 Differential I/O Standards

Configuration of the I/O modules as a differential pair is handled by Microsemi SoC Products Group Libero software when the user instantiates a differential I/O macro in the design. Differential I/Os can also be used in conjunction with the embedded Input register (InReg), Output register (OutReg), Enable register (EnReg), and Double Data Rate registers (DDR).

2.3.7.1 LVDS

Low-Voltage Differential Signaling (ANSI/TIA/EIA-644) is a high-speed, differential I/O standard.

Minimum and Maximum Input and Output Levels

Table 160 • LVDS Recommended DC Operating Conditions

Parameter	Symbol	Min	Typ	Max	Unit	Conditions
Supply voltage	V_{DDI}	2.375	2.5	2.625	V	2.5 V range
Supply voltage	V_{DDI}	3.15	3.3	3.45	V	3.3 V range

Table 161 • LVDS DC Input Voltage Specification

Parameter	Symbol	Min	Max	Unit	Conditions
DC Input voltage	V_I	0	2.925	V	2.5 V range
DC input voltage	V_I	0	3.45	V	3.3 V range
Input current high ¹	I_{IH} (DC)				
Input current low ¹	I_{IL} (DC)				

1. See Table 24, page 22.

Table 162 • LVDS DC Output Voltage Specification

Parameter	Symbol	Min	Typ	Max	Unit
DC output logic high	V_{OH}	1.25	1.425	1.6	V
DC output logic low	V_{OL}	0.9	1.075	1.25	V

Table 163 • LVDS DC Differential Voltage Specification

Parameter	Symbol	Min	Typ	Max	Unit
Differential output voltage swing	V_{OD}	250	350	450	mV
Output common mode voltage	V_{OCM}	1.125	1.25	1.375	V
Input common mode voltage	V_{ICM}	0.05	1.25	2.35	V
Input differential voltage	V_{ID}	100	350	600	mV

Table 164 • LVDS Minimum and Maximum AC Switching Speed

Parameter	Symbol	Max	Unit	Conditions
Maximum data rate (for MSIO I/O bank)	D_{MAX}	535	Mbps	AC loading: 12 pF / 100 Ω differential load
Maximum data rate (for MSIOD I/O bank) no pre-emphasis	D_{MAX}	620	Mbps	AC loading: 10 pF / 100 Ω differential load
		700	Mbps	AC loading: 2 pF / 100 Ω differential load

Table 165 • LVDS AC Impedance Specifications

Parameter	Symbol	Typ	Max	Unit
Termination resistance	R_T	100		Ω

Table 166 • LVDS AC Test Parameter Specifications

Parameter	Symbol	Typ	Unit
Measuring/trip point for data path	V_{TRIP}	Cross point	V
Resistance for enable path (T_{ZH} , T_{ZL} , T_{HZ} , T_{LZ})	R_{ENT}	2K	Ω
Capacitive loading for enable path (T_{ZH} , T_{ZL} , T_{HZ} , T_{LZ})	C_{ENT}	5	pF

LVDS25 AC Switching Characteristics

Worst commercial-case conditions: $T_J = 85^\circ\text{C}$, $V_{DD} = 1.14\text{ V}$, $V_{DDI} = 2.375\text{ V}$

Table 167 • LVDS25 Receiver Characteristics for MSIO I/O Bank (Input Buffers)

On-Die Termination (ODT)	T_{PY}		Unit
	-1	-Std	
None	2.774	3.263	ns
100	2.775	3.264	ns

Table 168 • LVDS25 Receiver Characteristics for MSIOD I/O Bank (Input Buffers)

On-Die Termination (ODT)	T_{PY}		Unit
	-1	-Std	
None	2.554	3.004	ns
100	2.549	2.999	ns

Table 169 • LVDS25 Transmitter Characteristics for MSIO I/O Bank (Output and Tristate Buffers)

T_{DP}		T_{ZL}		T_{ZH}		T_{HZ}		T_{LZ}		Unit
-1	-Std	-1	-Std	-1	-Std	-1	-Std	-1	-Std	
2.136	2.513	2.416	2.842	2.402	2.825	2.423	2.85	2.409	2.833	ns

Table 170 • LVDS25 Transmitter Characteristics for MSIOD I/O Bank (Output and Tristate Buffers)

	T_{DP}		T_{ZL}		T_{ZH}		T_{HZ}		T_{LZ}		Unit
	-1	-Std	-1	-Std	-1	-Std	-1	-Std	-1	-Std	
No pre-emphasis	1.61	1.893	1.749	2.058	1.735	2.041	1.897	2.231	1.866	2.195	ns
Min pre-emphasis	1.527	1.796	1.757	2.067	1.744	2.052	1.905	2.241	1.876	2.207	ns
Med pre-emphasis	1.496	1.76	1.765	2.077	1.751	2.06	1.914	2.252	1.884	2.216	ns

LVDS33 AC Switching Characteristics**Table 171 • LVDS33 Receiver Characteristics for MSIO I/O Bank (Input Buffers)**

On Die Termination (ODT)	T_{PY}		Unit
	-1	-Std	
None	2.572	3.025	ns
100	2.569	3.023	ns

Table 172 • LVDS33 Transmitter Characteristics for MSIO I/O Bank (Output and Tristate Buffers)

T_{DP}		T_{ZL}		T_{ZH}		T_{HZ}		T_{LZ}		Unit
-1	-Std	-1	-Std	-1	-Std	-1	-Std	-1	-Std	
1.942	2.284	1.98	2.33	1.97	2.318	1.953	2.298	1.96	2.307	ns

2.3.7.2 B-LVDS

Bus LVDS (B-LVDS) specifications extend the existing LVDS standard to high-performance multipoint bus applications. Multidrop and multipoint bus configurations may contain any combination of drivers, receivers, and transceivers.

Minimum and Maximum DC/AC Input and Output Levels Specification

Table 173 • B-LVDS Recommended DC Operating Conditions

Parameter	Symbol	Min	Typ	Max	Unit
Supply voltage	V_{DDI}	2.375	2.5	2.625	V

Table 174 • B-LVDS DC Input Voltage Specification

Parameter	Symbol	Min	Max	Unit
DC input voltage	V_I	0	2.925	V
Input current high ¹	I_{IH} (DC)			
Input current low ¹	I_{IL} (DC)			

1. See Table 24, page 22.

Table 175 • B-LVDS DC Output Voltage Specification (for MSIO I/O Bank Only)

Parameter	Symbol	Min	Typ	Max	Unit
DC output logic high	V_{OH}	1.25	1.425	1.6	V
DC output logic low	V_{OL}	0.9	1.075	1.25	V

Table 176 • B-LVDS DC Differential Voltage Specification

Parameter	Symbol	Min	Max	Unit
Differential output voltage swing (for MSIO I/O bank only)	V_{OD}	65	460	mV
Output common mode voltage (for MSIO I/O bank only)	V_{OCM}	1.1	1.5	V
Input common mode voltage	V_{ICM}	0.05	2.4	V
Input differential voltage	V_{ID}	0.1	V_{DDI}	V

Table 177 • B-LVDS Minimum and Maximum AC Switching Speed

Parameter	Symbol	Max	Unit	Conditions
Maximum data rate (for MSIO I/O bank)	D_{MAX}	500	Mbps	AC loading: 2 pF / 100 Ω differential load

Table 178 • B-LVDS AC Impedance Specifications

Parameter	Symbol	Typ	Unit
Termination resistance	R_T	27	Ω

Table 179 • B-LVDS AC Test Parameter Specifications

Parameter	Symbol	Typ	Unit
Measuring/trip point for data path	V_{TRIP}	Cross point	V
Resistance for enable path (T_{ZH} , T_{ZL} , T_{HZ} , T_{LZ})	R_{ENT}	2K	Ω
Capacitive loading for enable path (T_{ZH} , T_{ZL} , T_{HZ} , T_{LZ})	C_{ENT}	5	pF

AC Switching Characteristics

Worst commercial-case conditions: $T_J = 85\text{ }^\circ\text{C}$, $V_{DD} = 1.14\text{ V}$, $V_{DDI} = 2.375\text{ V}$.

Table 180 • B-LVDS AC Switching Characteristics for Receiver for MSIO I/O Bank (Input Buffers)

On-Die Termination (ODT)	T_{PY}		Unit
	-1	-Std	
None	2.738	3.221	ns
100	2.735	3.218	ns

Table 181 • B-LVDS AC Switching Characteristics for Receiver for MSIOD I/O Bank (Input Buffers)

On-Die Termination (ODT)	T_{PY}		Unit
	-1	-Std	
None	2.495	2.934	ns
100	2.495	2.935	ns

Table 182 • B-LVDS AC Switching Characteristics for Transmitter (for MSIO I/O Bank - Output and Tristate Buffers)

T_{DP}		T_{ZL}		T_{ZH}		T_{HZ}		T_{LZ}		Unit
-1	-Std	-1	-Std	-1	-Std	-1	-Std	-1	-Std	
2.258	2.656	2.343	2.756	2.329	2.74	2.12	2.494	2.123	2.497	ns

2.3.7.3 M-LVDS

M-LVDS specifications extend the existing LVDS standard to high-performance multipoint bus applications. Multidrop and multipoint bus configurations may contain any combination of drivers, receivers, and transceivers.

Minimum and Maximum Input and Output Levels

Table 183 • M-LVDS Recommended DC Operating Conditions

Parameter	Symbol	Min	Typ	Max	Unit
Supply voltage ¹	V_{DDI}	2.375	2.5	2.625	V

1. Only M-LVDS TYPE I is supported.

Table 184 • M-LVDS DC Input Voltage Specification

Parameter	Symbol	Min	Max	Unit
DC input voltage	V_I	0	2.925	V
Input current high ¹	I_{IH} (DC)			
Input current low ²	I_{IL} (DC)			

1. See Table 24, page 22.

Table 185 • M-LVDS DC Voltage Specification Output Voltage Specification (for MSIO I/O Bank Only)

Parameter	Symbol	Min	Typ	Max	Unit
DC output logic high	V_{OH}	1.25	1.425	1.6	V
DC output logic low	V_{OL}	0.9	1.075	1.25	V

Table 186 • M-LVDS Differential Voltage Specification

Parameter	Symbol	Min	Max	Unit
Differential output voltage swing (for MSIO I/O bank only)	V_{OD}	300	650	mV
Output common mode voltage (for MSIO I/O bank only)	V_{OCM}	0.3	2.1	V
Input common mode voltage	V_{ICM}	0.3	1.2	V
Input differential voltage	V_{ID}	50	2400	mV

Table 187 • M-LVDS Minimum and Maximum AC Switching Speed for MSIO I/O Bank

Parameter	Symbol	Max	Unit	Conditions
Maximum data rate	D_{MAX}	500	Mbps	AC loading: 2 pF / 100 Ω differential load

Table 188 • M-LVDS AC Impedance Specifications

Parameter	Symbol	Typ	Unit
Termination resistance	R_T	50	Ω

Table 189 • M-LVDS AC Test Parameter Specifications

Parameter	Symbol	Typ	Unit
Measuring/trip point for data path	V_{TRIP}	Cross point	V
Resistance for enable path (T_{ZH} , T_{ZL} , T_{HZ} , T_{LZ})	R_{ENT}	2K	Ω
Capacitive loading for enable path (T_{ZH} , T_{ZL} , T_{HZ} , T_{LZ})	C_{ENT}	5	pF

AC Switching Characteristics

Worst commercial-case conditions: $T_J = 85\text{ }^\circ\text{C}$, $V_{DD} = 1.14\text{ V}$, $V_{DDI} = 2.375\text{ V}$

Table 190 • M-LVDS AC Switching Characteristics for Receiver (for MSIO I/O Bank - Input Buffers)

On-Die Termination (ODT)	T_{PY}		Unit
	-1	-Std	
None	2.738	3.221	ns
100	2.735	3.218	ns

Table 191 • M-LVDS AC Switching Characteristics for Receiver (for MSIOD I/O Bank - Input Buffers)

On-Die Termination (ODT)	T_{PY}		Unit
	-1	-Std	
None	2.495	2.934	ns
100	2.495	2.935	ns

Table 192 • M-LVDS AC Switching Characteristics for Transmitter (for MSIO I/O Bank - Output and Tristate Buffers)

T_{DP}		T_{ZL}		T_{ZH}		T_{HZ}		T_{LZ}		Unit
-1	-Std	-1	-Std	-1	-Std	-1	-Std	-1	-Std	
2.258	2.656	2.348	2.762	2.334	2.746	2.123	2.497	2.125	2.5	ns

2.3.7.4 Mini-LVDS

Mini-LVDS is an unidirectional interface from the timing controller to the column drivers and is designed to the Texas Instruments Standard SLDA007A.

Mini-LVDS Minimum and Maximum Input and Output Levels

Table 193 • Mini-LVDS Recommended DC Operating Conditions

Parameter	Symbol	Min	Typ	Max	Unit
Supply voltage	V_{DDI}	2.375	2.5	2.625	V

Table 194 • Mini-LVDS DC Input Voltage Specification

Parameter	Symbol	Min	Max	Unit
DC Input voltage	V_I	0	2.925	V

Table 195 • Mini-LVDS DC Output Voltage Specification

Parameter	Symbol	Min	Typ	Max	Unit
DC output logic high	V_{OH}	1.25	1.425	1.6	V
DC output logic low	V_{OL}	0.9	1.075	1.25	V

Table 196 • Mini-LVDS DC Differential Voltage Specification

Parameter	Symbol	Min	Max	Unit
Differential output voltage swing	V_{OD}	300	600	mV
Output common mode voltage	V_{OCM}	1	1.4	V
Input common mode voltage	V_{ICM}	0.3	1.2	V
Input differential voltage	V_{ID}	100	600	mV

Table 197 • Mini-LVDS Minimum and Maximum AC Switching Speed

Parameter	Symbol	Max	Unit	Conditions
Maximum data rate (for MSIO I/O bank)	D_{MAX}	520	Mbps	AC loading: 2 pF / 100 Ω differential load
Maximum data rate (for MSIOD I/O bank)	D_{MAX}	700	Mbps	AC loading: 2 pF / 100 Ω differential load

Table 198 • Mini-LVDS AC Impedance Specifications

Parameter	Symbol	Typ	Unit
Termination resistance	R_T	100	Ω

Table 199 • Mini-LVDS AC Test Parameter Specifications

Parameter	Symbol	Typ	Unit
Measuring/trip point for data path	V_{TRIP}	Cross point	V
Resistance for enable path (T_{ZH} , T_{ZL} , T_{HZ} , T_{LZ})	R_{ENT}	2K	Ω
Capacitive loading for enable path (T_{ZH} , T_{ZL} , T_{HZ} , T_{LZ})	C_{ENT}	5	pF

AC Switching Characteristics

Worst commercial-case conditions: $T_J = 85^\circ\text{C}$, $V_{DD} = 1.14\text{ V}$, $V_{DDI} = 2.375\text{ V}$.

Table 200 • Mini-LVDS AC Switching Characteristics for Receiver (for MSIO I/O Bank - Input Buffers)

On-Die Termination (ODT)	T_{PY}		Unit
	-1	-Std	
None	2.855	3.359	ns
100	2.85	3.353	ns
None	2.602	3.061	ns
100	2.597	3.055	ns

Table 201 • Mini-LVDS AC Switching Characteristics for Transmitter for MSIO I/O Bank (Output and Tristate Buffers)

T_{DP}		T_{ZL}		T_{ZH}		T_{HZ}		T_{LZ}		Unit
-1	-Std	-1	-Std	-1	-Std	-1	-Std	-1	-Std	
2.097	2.467	2.308	2.715	2.296	2.701	1.964	2.31	1.949	2.293	ns

Table 202 • Mini-LVDS AC Switching Characteristics for Transmitter (for MSIOD I/O Bank - Output and Tristate Buffers)

	T_{DP}		T_{ZL}		T_{ZH}		T_{HZ}		T_{LZ}		Unit
	-1	-Std	-1	-Std	-1	-Std	-1	-Std	-1	-Std	
No pre-emphasis	1.614	1.899	1.562	1.837	1.553	1.826	1.593	1.874	1.578	1.856	ns
Min pre-emphasis	1.604	1.887	1.745	2.053	1.731	2.036	1.892	2.225	1.861	2.189	ns
Med pre-emphasis	1.521	1.79	1.753	2.062	1.737	2.043	1.9	2.235	1.868	2.197	ns
Max pre-emphasis	1.492	1.754	1.762	2.073	1.745	2.052	1.91	2.247	1.876	2.206	ns

2.3.7.5 RSDS

Reduced Swing Differential Signaling (RSDS) is similar to an LVDS high-speed interface using differential signaling. RSDS has a similar implementation to LVDS devices and is only intended for point-to-point applications.

Minimum and Maximum Input and Output Levels

Table 203 • RSDS Recommended DC Operating Conditions

Parameter	Symbol	Min	Typ	Max	Unit
Supply voltage	V_{DDI}	2.375	2.5	2.625	V

Table 204 • RSDS DC Input Voltage Specification

Parameter	Symbol	Min	Max	Unit
DC input voltage	V_I	0	2.925	V

Table 205 • RSDS DC Output Voltage Specification

Parameter	Symbol	Min	Typ	Max	Unit
DC output logic high	V_{OH}	1.25	1.425	1.6	V
DC output logic low	V_{OL}	0.9	1.075	1.25	V

Table 206 • RSDS Differential Voltage Specification

Parameter	Symbol	Min	Max	Unit
Differential output voltage swing	V_{OD}	100	600	mV
Output common mode voltage	V_{OCM}	0.5	1.5	V
Input common mode voltage	V_{ICM}	0.3	1.5	V
Input differential voltage	V_{ID}	100	600	mV

Table 207 • RSDS Minimum and Maximum AC Switching Speed

Parameter	Symbol	Max	Unit	Conditions
Maximum data rate (for MSIO I/O bank)	D_{MAX}	520	Mbps	AC loading: 2 pF / 100 Ω differential load
Maximum data rate (for MSIOD I/O bank)	D_{MAX}	700	Mbps	AC loading: 2 pF / 100 Ω differential load

Table 208 • RSDS AC Impedance Specifications

Parameter	Symbol	Typ	Unit
Termination resistance	RT	100	Ω

Table 209 • RSDS AC Test Parameter Specifications

Parameter	Symbol	Typ	Unit
Measuring/trip point for data path	V_{TRIP}	Cross point	V
Resistance for enable path (T_{ZH} , T_{ZL} , T_{HZ} , T_{LZ})	R_{ENT}	2K	Ω
Capacitive loading for enable path (T_{ZH} , T_{ZL} , T_{HZ} , T_{LZ})	C_{ENT}	5	pF

AC Switching Characteristics

Worst commercial-case conditions: $T_J = 85\text{ }^\circ\text{C}$, $V_{DD} = 1.14\text{ V}$, $V_{DDI} = 2.375\text{ V}$.

Table 210 • RSDS AC Switching Characteristics for Receiver (for MSIO I/O Bank - Input Buffers)

On-Die Termination (ODT)	T_{PY}		Unit
	-1	-Std	
None	2.855	3.359	ns
100	2.85	3.353	ns

Table 211 • RSDS AC Switching Characteristics for Receiver (for MSIOD I/O Bank - Input Buffers)

On-Die Termination (ODT)	T_{PY}		Unit
	-1	-Std	
None	2.602	3.061	ns
100	2.597	3.055	ns

Table 212 • RSDS AC Switching Characteristics for Transmitter (for MSIO I/O Bank - Output and Tristate Buffers)

T_{DP}		T_{ZL}		T_{ZH}		T_{HZ}		T_{LZ}		Unit
-1	-Std	-1	-Std	-1	-Std	-1	-Std	-1	-Std	
2.097	2.467	2.303	2.709	2.291	2.695	1.961	2.307	1.947	2.29	ns

Table 213 • RSDS AC Switching Characteristics for Transmitter (for MSIOD I/O Bank - Output and Tristate Buffers)

	T_{DP}		T_{ZL}		T_{ZH}		T_{HZ}		T_{LZ}		Unit
	-1	-Std	-1	-Std	-1	-Std	-1	-Std	-1	-Std	
No pre-emphasis	1.614	1.899	1.559	1.834	1.55	1.823	1.59	1.87	1.575	1.852	ns
Min pre-emphasis	1.604	1.887	1.742	2.05	1.728	2.032	1.889	2.222	1.858	2.185	ns
Med pre-emphasis	1.521	1.79	1.753	2.062	1.737	2.043	1.9	2.235	1.868	2.197	ns
Max pre-emphasis	1.492	1.754	1.762	2.073	1.745	2.052	1.91	2.247	1.876	2.206	ns

2.3.7.6 LVPECL

Low-Voltage Positive Emitter-Coupled Logic (LVPECL) is another differential I/O standard. It requires that one data bit be carried through two signal lines. Similar to LVDS, two pins are needed. It also requires external resistor termination. IGLOO2 and SmartFusion2 SoC FPGAs support only LVPECL receivers and do not support LVPECL transmitters.

Minimum and Maximum Input and Output Levels (Applicable to MSIO I/O Bank Only)

Table 214 • LVPECL Recommended DC Operating Conditions

Parameter	Symbol	Min	Typ	Max	Unit
Supply voltage	V_{DDI}	3.15	3.3	3.45	V

Table 215 • LVPECL DC Input Voltage Specification

Parameter	Symbol	Min	Max	Unit
DC input voltage	V_I	0	3.45	V

Table 216 • LVPECL DC Differential Voltage Specification

Parameter	Symbol	Min	Typ	Max	Unit
Input common mode voltage	V_{ICM}	0.3		2.8	V
Input differential voltage	V_{IDIFF}	100	300	1,000	mV

Table 217 • LVPECL Minimum and Maximum AC Switching Speeds

Parameter	Symbol	Max	Unit
Maximum data rate	D_{MAX}	900	Mbps

AC Switching Characteristics

Worst commercial-case conditions: $T_J = 85\text{ }^\circ\text{C}$, $V_{DD} = 1.14\text{ V}$, $V_{DDI} = 2.375\text{ V}$.

Table 218 • LVPECL Receiver Characteristics for MSIO I/O Bank

On-Die Termination (ODT)	T_{PY}		Unit
	-1	-Std	
None	2.572	3.025	ns
100	2.569	3.023	ns

2.3.8 I/O Register Specifications

This section describes input and output register specifications.

2.3.8.1 Input Register**Figure 6 • Timing Model for Input Register**

Figure 7 • I/O Register Input Timing Diagram



The following table lists the input data register propagation delays in worst commercial-case conditions when $T_J = 85\text{ }^\circ\text{C}$, $V_{DD} = 1.14\text{ V}$.

Table 219 • Input Data Register Propagation Delays

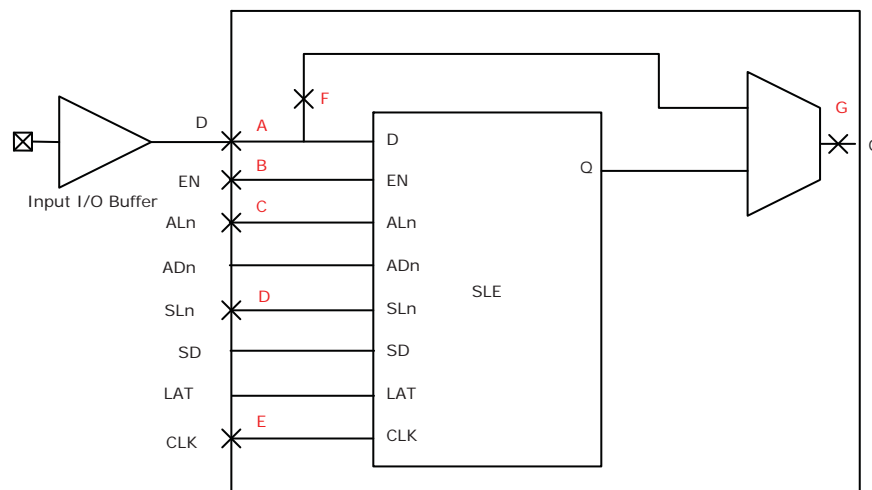
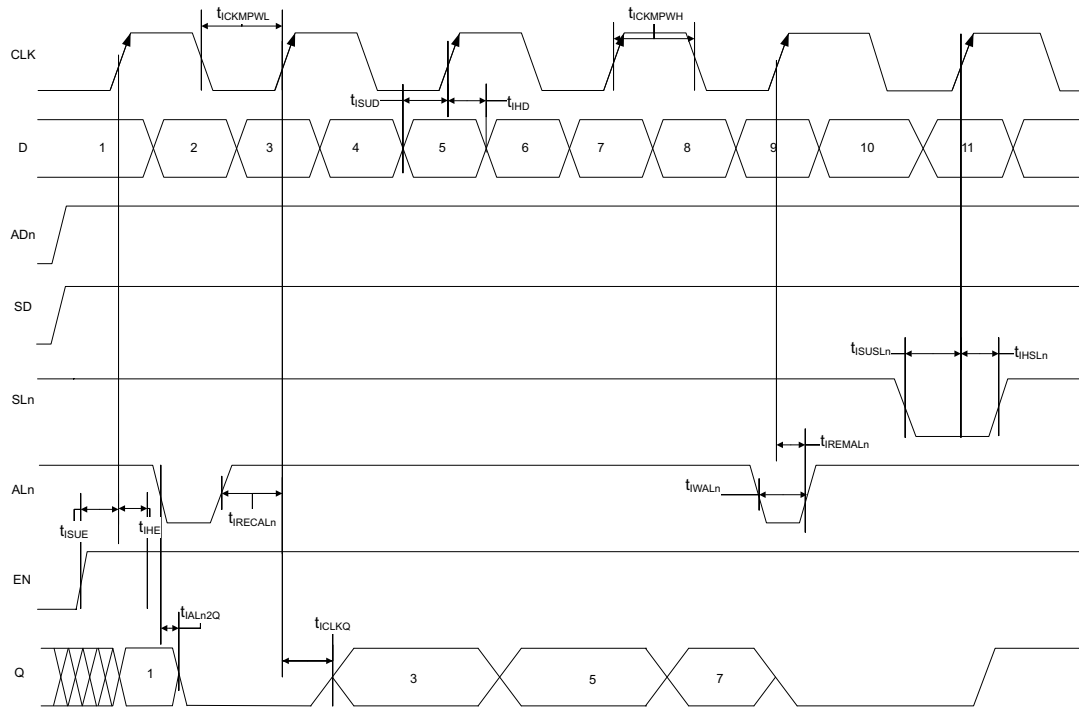
Parameter	Symbol	Measuring Nodes (from, to) ¹	-1		Unit
			-Std		
Bypass delay of the input register	T_{IBYP}	F, G	0.353	0.415	ns
Clock-to-Q of the input register	T_{ICLKQ}	E, G	0.16	0.188	ns
Data setup time for the input register	T_{ISUD}	A, E	0.357	0.421	ns
Data hold time for the input register	T_{IHD}	A, E	0	0	ns
Enable setup time for the input register	T_{ISUE}	B, E	0.46	0.542	ns
Enable hold time for the input register	T_{IHE}	B, E	0	0	ns
Synchronous load setup time for the input register	T_{ISUSL}	D, E	0.46	0.542	ns
Synchronous load hold time for the input register	T_{IHSL}	D, E	0	0	ns
Asynchronous clear-to-Q of the input register (ADn=1)	T_{IALN2Q}	C, G	0.625	0.735	ns
Asynchronous preset-to-Q of the input register (ADn=0)		C, G	0.587	0.69	ns
Asynchronous load removal time for the input register	$T_{IREMALN}$	C, E	0	0	ns
Asynchronous load recovery time for the input register	$T_{IRECALN}$	C, E	0.074	0.087	ns
Asynchronous load minimum pulse width for the input register	T_{IWALN}	C, C	0.304	0.357	ns
Clock minimum pulse width high for the input register	$T_{ICKMPWH}$	E, E	0.075	0.088	ns
Clock minimum pulse width low for the input register	$T_{ICKMPWL}$	E, E	0.159	0.187	ns

1. For the derating values at specific junction temperature and voltage supply levels, see [Table 16](#), page 14 for derating values.

2.3.8.2 Output/Enable Register

Figure 8 • Timing Model for Output/Enable Register

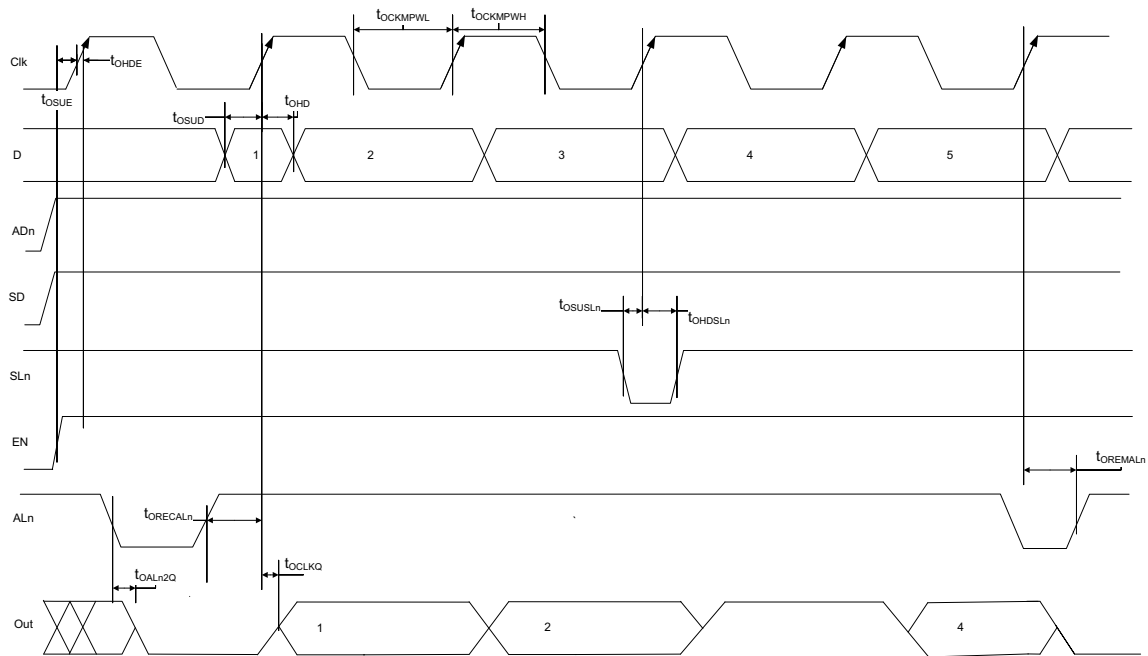

Figure 9 • I/O Register Output Timing Diagram

The following table lists the output/enable propagation delays in worst commercial-case conditions when $T_J = 85^\circ\text{C}$, $V_{DD} = 1.14\text{ V}$.

Table 220 • Output/Enable Data Register Propagation Delays

Parameter	Symbol	Measuring Nodes (from, to) ¹	-1		Unit
			-1	-Std	
Bypass delay of the output/enable register	T_{OBYP}	F, G or H, I	0.353	0.415	ns
Clock-to-Q of the output/enable register	T_{OCLKQ}	E, G or E, I	0.263	0.309	ns
Data setup time for the output/enable register	T_{OSUD}	A, E or J, E	0.19	0.223	ns
Data hold time for the output/enable register	T_{OHD}	A, E or J, E	0	0	ns
Enable setup time for the output/enable register	T_{OSUE}	B, E	0.419	0.493	ns
Enable hold time for the output/enable register	T_{OHE}	B, E	0	0	ns
Synchronous load setup time for the output/enable register	T_{OSUSL}	D, E	0.196	0.231	ns
Synchronous load hold time for the output/enable register	T_{OHSL}	D, E	0	0	ns
Asynchronous clear-to-q of the output/enable register (ADn = 1)	T_{OALN2Q}	C, G or C, I	0.505	0.594	ns
Asynchronous preset-to-q of the output/enable register (ADn = 0)		C, G or C, I	0.528	0.621	ns
Asynchronous load removal time for the output/enable register	$T_{OREMALN}$	C, E	0	0	ns
Asynchronous load recovery time for the output/enable register	$T_{ORECALN}$	C, E	0.034	0.04	ns
Asynchronous load minimum pulse width for the output/enable register	T_{OWALN}	C, C	0.304	0.357	ns
Clock minimum pulse width high for the output/enable register	$T_{OACKMPWH}$	E, E	0.075	0.088	ns
Clock minimum pulse width low for the output/enable register	$T_{OACKMPWL}$	E, E	0.159	0.187	ns

1. For the derating values at specific junction temperature and voltage supply levels, see Table 16, page 14 for derating values.

2.3.9 DDR Module Specification

This section describes input and output DDR module and timing specifications.

2.3.9.1 Input DDR Module

Figure 10 • Input DDR Module



2.3.9.2 Input DDR Timing Diagram

Figure 11 • Input DDR Timing Diagram



2.3.9.3 Timing Characteristics

The following table lists the input DDR propagation delays in worst commercial-case conditions when $T_J = 85^\circ\text{C}$, $V_{DD} = 1.14\text{ V}$.

Table 221 • Input DDR Propagation Delays

Symbol	Description	Measuring Nodes (from, to)	-1	-Std	Unit
$T_{DDRICKLKQ1}$	Clock-to-Out Out_QR for input DDR	B, C	0.16	0.188	ns
$T_{DDRICKLKQ2}$	Clock-to-Out Out_QF for input DDR	B, D	0.166	0.195	ns
$T_{DDRISUD}$	Data setup for input DDR	A, B	0.357	0.421	ns
T_{DDRHD}	Data hold for input DDR	A, B	0	0	ns
$T_{DDRISUE}$	Enable setup for input DDR	E, B	0.46	0.542	ns
T_{DDRHE}	Enable hold for input DDR	E, B	0	0	ns
$T_{DDRISUSLn}$	Synchronous load setup for input DDR	G, B	0.46	0.542	ns
$T_{DDRHSLn}$	Synchronous load hold for input DDR	G, B	0	0	ns
$T_{DDRIR2Q1}$	Asynchronous load-to-out QR for input DDR	F, C	0.587	0.69	ns
$T_{DDRIR2Q2}$	Asynchronous load-to-out QF for input DDR	F, D	0.541	0.636	ns
$T_{DDRIREMAL}$	Asynchronous load removal time for input DDR	F, B	0	0	ns
$T_{DDRIRECAL}$	Asynchronous load recovery time for input DDR	F, B	0.074	0.087	ns

Table 221 • Input DDR Propagation Delays (continued)

Symbol	Description	Measuring Nodes (from, to)	-1	-Std	Unit
$T_{DDRIWAL}$	Asynchronous load minimum pulse width for input DDR	F, F	0.304	0.357	ns
$T_{DDRICKMPWH}$	Clock minimum pulse width high for input DDR	B, B	0.075	0.088	ns
$T_{DDRICKMPWL}$	Clock minimum pulse width low for input DDR	B, B	0.159	0.187	ns

2.3.9.4 Output DDR Module

Figure 12 • Output DDR Module

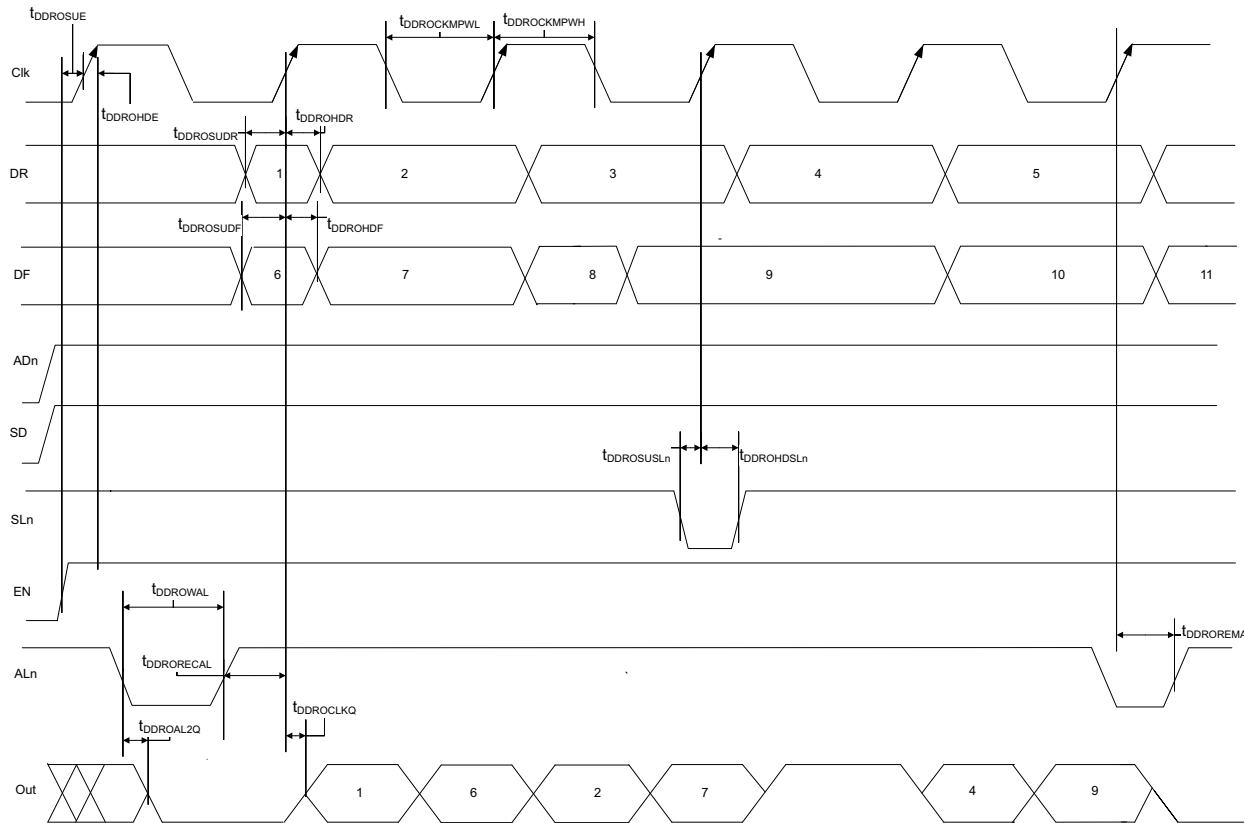

Figure 13 • Output DDR Timing Diagram**2.3.9.5 Timing Characteristics**

The following table lists the output DDR propagation delays in worst commercial-case conditions when $T_J = 85^\circ\text{C}$, $V_{DD} = 1.14\text{ V}$.

Table 222 • Output DDR Propagation Delays

Symbol	Description	Measuring Nodes (from, to)	-1	-Std	Unit
$T_{DDROCLKQ}$	Clock-to-out of DDR for output DDR	E, G	0.263	0.309	ns
$T_{DDROSUDF}$	Data_F data setup for output DDR	F, E	0.143	0.168	ns
$T_{DDROSUDR}$	Data_R data setup for output DDR	A, E	0.19	0.223	ns
$T_{DDROHDF}$	Data_F data hold for output DDR	F, E	0	0	ns
$T_{DDROHDR}$	Data_R data hold for output DDR	A, E	0	0	ns
$T_{DDROSUE}$	Enable setup for input DDR	B, E	0.419	0.493	ns
T_{DDROHE}	Enable hold for input DDR	B, E	0	0	ns
$T_{DDROSUSLIn}$	Synchronous load setup for input DDR	D, E	0.196	0.231	ns
$T_{DDROHSLIn}$	Synchronous load hold for input DDR	D, E	0	0	ns
$T_{DDROAL2Q}$	Asynchronous load-to-out for output DDR	C, G	0.528	0.621	ns
$T_{DDROREMA}$	Asynchronous load removal time for output DDR	C, E	0	0	ns
$T_{DDRORECAL}$	Asynchronous load recovery time for output DDR	C, E	0.034	0.04	ns

Table 222 • Output DDR Propagation Delays (continued)

Symbol	Description	Measuring Nodes (from, to)	-1		Unit
			-Std		
$T_{DDROWAL}$	Asynchronous load minimum pulse width for output DDR	C, C	0.304	0.357	ns
$T_{DDROCKMPWH}$	Clock minimum pulse width high for the output DDR	E, E	0.075	0.088	ns
$T_{DDROCKMPWL}$	Clock minimum pulse width low for the output DDR	E, E	0.159	0.187	ns

2.3.10 Logic Element Specifications

2.3.10.1 4-input LUT (LUT-4)

The IGLOO2 and SmartFusion2 SoC FPGAs offer a fully permutable 4-input LUT. In this section, timing characteristics are presented for a sample of the library. For more details, see [SmartFusion2 and IGLOO2 Macro Library Guide](#).

Figure 14 • LUT-4



2.3.10.2 Timing Characteristics

The following table lists the combinatorial cell propagation delays in worst commercial-case conditions when $T_J = 85\text{ }^\circ\text{C}$, $V_{DD} = 1.14\text{ V}$.

Table 223 • Combinatorial Cell Propagation Delays

Combinatorial Cell	Equation	Symbol	-1	-Std	Unit
INV	$Y = !A$	T_{PD}	0.1	0.118	ns
AND2	$Y = A \cdot B$	T_{PD}	0.164	0.193	ns
NAND2	$Y = !(A \cdot B)$	T_{PD}	0.147	0.173	ns
OR2	$Y = A + B$	T_{PD}	0.164	0.193	ns
NOR2	$Y = !(A + B)$	T_{PD}	0.147	0.173	ns
XOR2	$Y = A \oplus B$	T_{PD}	0.164	0.193	ns
XOR3	$Y = A \oplus B \oplus C$	T_{PD}	0.225	0.265	ns
AND3	$Y = A \cdot B \cdot C$	T_{PD}	0.209	0.246	ns
AND4	$Y = A \cdot B \cdot C \cdot D$	T_{PD}	0.287	0.338	ns

2.3.10.3 Sequential Module

IGLOO2 and SmartFusion2 SoC FPGAs offer a separate flip-flop which can be used independently from the LUT. The flip-flop can be configured as a register or a latch and has a data input and optional enable, synchronous load (clear or preset), and asynchronous load (clear or preset).

Figure 15 • Sequential Module

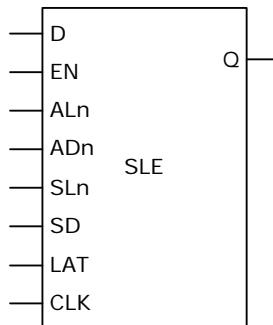

The following figure shows a configuration with SD = 0 (synchronous clear) and ADn = 1 (asynchronous clear) for a flip-flop (LAT = 0).

Figure 16 • Sequential Module Timing Diagram

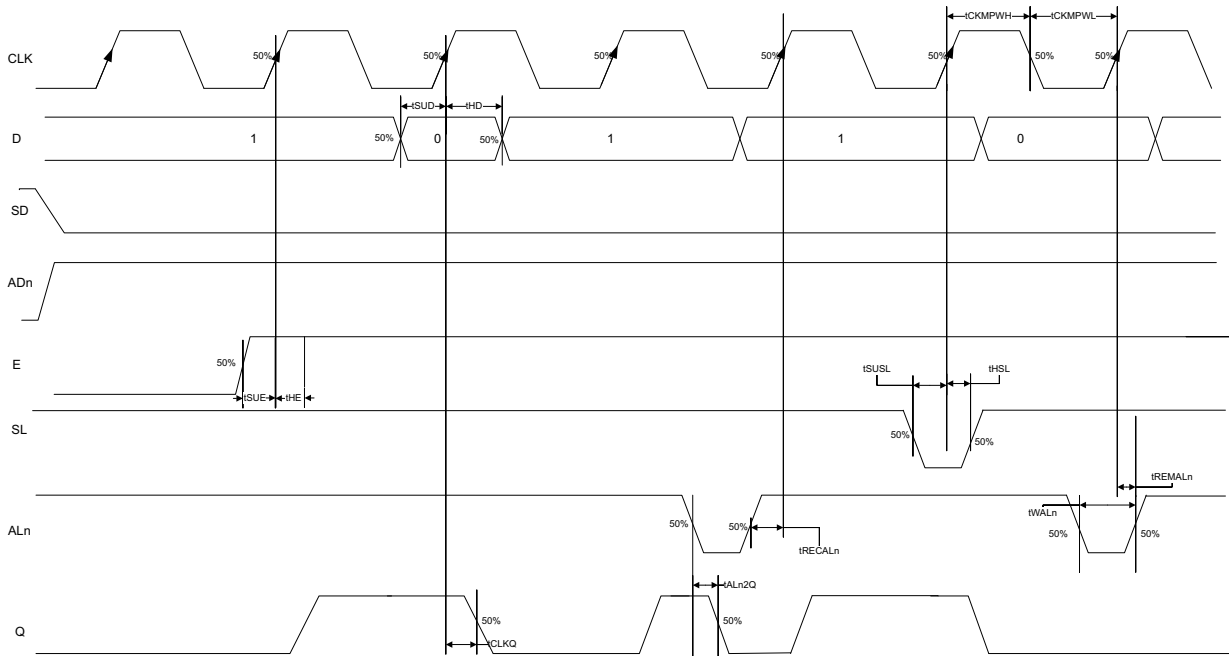

2.3.10.3.1 Timing Characteristics

The following table lists the register delays in worst commercial-case conditions when $T_J = 85^\circ\text{C}$, $V_{DD} = 1.14\text{ V}$.

Table 224 • Register Delays

Parameter	Symbol	-1	-Std	Unit
Clock-to-Q of the core register	T_{CLKQ}	0.108	0.127	ns
Data setup time for the core register	T_{SUD}	0.254	0.298	ns
Data hold time for the core register	T_{HD}	0	0	ns
Enable setup time for the core register	T_{SUE}	0.335	0.394	ns
Enable hold time for the core register	T_{HE}	0	0	ns
Synchronous load setup time for the core register	T_{SUSL}	0.335	0.394	ns
Synchronous load hold time for the core register	T_{HSL}	0	0	ns
Asynchronous Clear-to-Q of the core register (ADn = 1)	T_{ALn2Q}	0.473	0.556	ns
Asynchronous preset-to-Q of the core register (ADn = 0)		0.451	0.531	ns
Asynchronous load removal time for the core register	T_{RECALN}	0	0	ns
Asynchronous load recovery time for the core register	T_{RECALN}	0.353	0.415	ns
Asynchronous load minimum pulse width for the core register	T_{WALN}	0.266	0.313	ns
Clock minimum pulse width high for the core register	T_{CKMPWH}	0.065	0.077	ns
Clock minimum pulse width low for the core register	T_{CKMPWL}	0.139	0.164	ns

2.3.11 Global Resource Characteristics

The IGLOO2 and SmartFusion2 SoC FPGA devices offer a powerful, low skew global routing network which provides an effective clock distribution throughout the FPGA fabric. See [UG0445: IGLOO2 FPGA and SmartFusion2 SoC FPGA Fabric User Guide](#) for the positions of various global routing resources.

The following table lists the 150 device global resources in worst commercial-case conditions when $T_J = 85\text{ }^\circ\text{C}$, $V_{DD} = 1.14\text{ V}$.

Table 225 • 150 Device Global Resource

Parameter	Symbol	-1		-Std		Unit
		Min	Max	Min	Max	
Input low delay for global clock	T_{RCKL}	0.83	0.911	0.831	0.913	ns
Input high delay for global clock	T_{RCKH}	1.457	1.588	1.715	1.869	ns
Maximum skew for global clock	T_{RCKSW}		0.131		0.154	ns

The following table lists the 090 device global resources in worst commercial-case conditions when $T_J = 85\text{ }^\circ\text{C}$, $V_{DD} = 1.14\text{ V}$.

Table 226 • 090 Device Global Resource

Parameter	Symbol	-1		-Std		Unit
		Min	Max	Min	Max	
Input low delay for global clock	T_{RCKL}	0.835	0.888	0.833	0.886	ns
Input high delay for global clock	T_{RCKH}	1.405	1.489	1.654	1.752	ns
Maximum skew for global clock	T_{RCKSW}		0.084		0.098	ns

The following table lists the 050 device global resources in worst commercial-case conditions when $T_J = 85\text{ }^\circ\text{C}$, $V_{DD} = 1.14\text{ V}$.

Table 227 • 050 Device Global Resource

Parameter	Symbol	-1		-Std		Unit
		Min	Max	Min	Max	
Input low delay for global clock	T_{RCKL}	0.827	0.897	0.826	0.896	ns
Input high delay for global clock	T_{RCKH}	1.419	1.53	1.671	1.8	ns
Maximum skew for global clock	T_{RCKSW}		0.111		0.129	ns

The following table lists the 025 device global resources in worst commercial-case conditions when $T_J = 85\text{ }^\circ\text{C}$, $V_{DD} = 1.14\text{ V}$.

Table 228 • 025 Device Global Resource

Parameter	Symbol	-1		-Std		Unit
		Min	Max	Min	Max	
Input low delay for global clock	T_{RCKL}	0.747	0.799	0.745	0.797	ns
Input high delay for global clock	T_{RCKH}	1.294	1.378	1.522	1.621	ns
Maximum skew for global clock	T_{RCKSW}		0.084		0.099	ns

The following table lists the 010 device global resources in worst commercial-case conditions when $T_J = 85\text{ }^\circ\text{C}$, $V_{DD} = 1.14\text{ V}$.

Table 229 • 010 Device Global Resource

Parameter	Symbol	-1		-Std		Unit
		Min	Max	Min	Max	
Input low delay for global clock	T_{RCKL}	0.626	0.669	0.627	0.668	ns
Input high delay for global clock	T_{RCKH}	1.112	1.182	1.308	1.393	ns
Maximum skew for global clock	T_{RCKSW}		0.07		0.085	ns

The following table lists the 005 device global resources in worst commercial-case conditions when $T_J = 85\text{ }^\circ\text{C}$, $V_{DD} = 1.14\text{ V}$.

Table 230 • 005 Device Global Resource

Parameter	Symbol	-1		-Std		Unit
		Min	Max	Min	Max	
Input low delay for global clock	T_{RCKL}	0.625	0.66	0.628	0.66	ns
Input high delay for global clock	T_{RCKH}	1.126	1.187	1.325	1.397	ns
Maximum skew for global clock	T_{RCKSW}		0.061		0.072	ns

2.3.12 FPGA Fabric SRAM

See *UG0445: IGLOO2 FPGA and SmartFusion2 SoC FPGA Fabric User Guide* for more information.

2.3.12.1 FPGA Fabric Large SRAM (LSRAM)

The following table lists the RAM1K18 – dual-port mode for depth × width configuration 1K × 18 in worst commercial-case conditions when $T_J = 85\text{ }^\circ\text{C}$, $V_{DD} = 1.14\text{ V}$.

Table 231 • RAM1K18 – Dual-Port Mode for Depth × Width Configuration 1K × 18

Parameter	Symbol	-1		-Std		Unit
		Min	Max	Min	Max	
Clock period	T_{CY}	2.5		2.941		ns
Clock minimum pulse width high	$T_{CLKMPWH}$	1.125		1.323		ns
Clock minimum pulse width low	$T_{CLKMPWL}$	1.125		1.323		ns
Pipelined clock period	T_{PLCY}	2.5		2.941		ns
Pipelined clock minimum pulse width high	$T_{PLCLKMPWH}$	1.125		1.323		ns
Pipelined clock minimum pulse width low	$T_{PLCLKMPWL}$	1.125		1.323		ns
Read access time with pipeline register				0.334	0.393	ns
Read access time without pipeline register	T_{CLK2Q}			2.273	2.674	ns
Access time with feed-through write timing				1.529	1.799	ns
Address setup time	T_{ADDRSU}	0.441		0.519		ns
Address hold time	T_{ADDRHD}	0.274		0.322		ns
Data setup time	T_{DSU}	0.341		0.401		ns
Data hold time	T_{DHD}	0.107		0.126		ns
Block select setup time	T_{BLKSU}	0.207		0.244		ns

Table 231 • RAM1K18 – Dual-Port Mode for Depth x Width Configuration 1K x 18 (continued)

Parameter	Symbol	-1		-Std		Unit
		Min	Max	Min	Max	
Block select hold time	T _{BLKH} D	0.216		0.254		ns
Block select to out disable time (when pipelined register is disabled)	T _{BLK2} Q		1.529		1.799	ns
Block select minimum pulse width	T _{BLKMP} W	0.186		0.219		ns
Read enable setup time	T _{RDES} U	0.449		0.528		ns
Read enable hold time	T _{RDEH} D	0.167		0.197		ns
Pipelined read enable setup time (A_DOUT_EN, B_DOUT_EN)	T _{RDPLE} SU	0.248		0.291		ns
Pipelined read enable hold time (A_DOUT_EN, B_DOUT_EN)	T _{RDPLE} HD	0.102		0.12		ns
Asynchronous reset to output propagation delay	T _{R2} Q	–	1.506	–	1.772	ns
Asynchronous reset removal time	T _{RSTRE} M	0.506		0.595		ns
Asynchronous reset recovery time	T _{RSTRE} C	0.004		0.005		ns
Asynchronous reset minimum pulse width	T _{RSTMP} W	0.301		0.354		ns
Pipelined register asynchronous reset removal time	T _{PLRSTRE} M	–0.279		–0.328		ns
Pipelined register asynchronous reset recovery time	T _{PLRSTRE} C	0.327		0.385		ns
Pipelined register asynchronous reset minimum pulse width	T _{PLRSTMP} W	0.282		0.332		ns
Synchronous reset setup time	T _{SRSTS} U	0.226		0.265		ns
Synchronous reset hold time	T _{SRSTH} D	0.036		0.043		ns
Write enable setup time	T _{WES} U	0.39		0.458		ns
Write enable hold time	T _{WEH} D	0.242		0.285		ns
Maximum frequency	F _{MAX}		400		340	MHz

The following table lists the RAM1K18 – dual-port mode for depth x width configuration 2K x 9 in worst commercial-case conditions when T_J = 85 °C, V_{DD} = 1.14 V.

Table 232 • RAM1K18 – Dual-Port Mode for Depth x Width Configuration 2K x 9

Parameter	Symbol	-1		-Std		Unit
		Min	Max	Min	Max	
Clock period	T _{CY}	2.5		2.941		ns
Clock minimum pulse width high	T _{CLKMP} WH	1.125		1.323		ns
Clock minimum pulse width low	T _{CLKMP} WL	1.125		1.323		ns
Pipelined clock period	T _{PLCY}	2.5		2.941		ns
Pipelined clock minimum pulse width high	T _{PLCLKMP} WH	1.125		1.323		ns
Pipelined clock minimum pulse width low	T _{PLCLKMP} WL	1.125		1.323		ns
Read access time with pipeline register			0.334		0.393	ns
Read access time without pipeline register	T _{CLK2} Q		2.273		2.674	ns
Access time with feed-through write timing			1.529		1.799	ns

Table 232 • RAM1K18 – Dual-Port Mode for Depth × Width Configuration 2K × 9 (continued)

Parameter	Symbol	–1		–Std		Unit
		Min	Max	Min	Max	
Address setup time	T_{ADDRSU}	0.475		0.559		ns
Address hold time	T_{ADDRHD}	0.274		0.322		ns
Data setup time	T_{DSU}	0.336		0.395		ns
Data hold time	T_{DHD}	0.082		0.096		ns
Block select setup time	T_{BLKSU}	0.207		0.244		ns
Block select hold time	T_{BLKHD}	0.216		0.254		ns
Block select to out disable time (when pipelined register is disabled)	T_{BLK2Q}		1.529		1.799	ns
Block select minimum pulse width	T_{BLKMPW}	0.186		0.219		ns
Read enable setup time	T_{RDESU}	0.485		0.57		ns
Read enable hold time	T_{RDEHD}	0.071		0.083		ns
Pipelined read enable setup time (A_DOUT_EN, B_DOUT_EN)	$T_{RDPLESU}$	0.248		0.291		ns
Pipelined read enable hold time (A_DOUT_EN, B_DOUT_EN)	$T_{RDPLEHD}$	0.102		0.12		ns
Asynchronous reset to output propagation delay	T_{R2Q}		1.514		1.781	ns
Asynchronous reset removal time	T_{RSTREM}	0.506		0.595		ns
Asynchronous reset recovery time	T_{RSTREC}	0.004		0.005		ns
Asynchronous reset minimum pulse width	T_{RSTMPW}	0.301		0.354		ns
Pipelined register asynchronous reset removal time	$T_{PLRSTREM}$	–0.279		–0.328		ns
Pipelined register asynchronous reset recovery time	$T_{PLRSTREC}$	0.327		0.385		ns
Pipelined register asynchronous reset minimum pulse width	$T_{PLRSTMPW}$	0.282		0.332		ns
Synchronous reset setup time	T_{SRSTSU}	0.226		0.265		ns
Synchronous reset hold time	T_{SRSTHD}	0.036		0.043		ns
Write enable setup time	T_{WESU}	0.415		0.488		ns
Write enable hold time	T_{WEHD}	0.048		0.057		ns
Maximum frequency	F_{MAX}		400		340	MHz

The following table lists the RAM1K18 – dual-port mode for depth × width configuration 4K × 4 in worst commercial-case conditions when $T_J = 85\text{ }^\circ\text{C}$, $V_{DD} = 1.14\text{ V}$.

Table 233 • RAM1K18 – Dual-Port Mode for Depth × Width Configuration 4K × 4

Parameter	Symbol	–1		–Std		Unit
		Min	Max	Min	Max	
Clock period	T_{CY}	2.5		2.941		ns
Clock minimum pulse width high	$T_{CLKMPWH}$	1.125		1.323		ns
Clock minimum pulse width low	$T_{CLKMPWL}$	1.125		1.323		ns
Pipelined clock period	T_{PLCY}	2.5		2.941		ns
Pipelined clock minimum pulse width high	$T_{PLCLKMPWH}$	1.125		1.323		ns

Table 233 • RAM1K18 – Dual-Port Mode for Depth x Width Configuration 4K x 4 (continued)

Parameter	Symbol	-1		-Std		Unit
		Min	Max	Min	Max	
Pipelined clock minimum pulse width low	$T_{PLCLKMPWL}$	1.125		1.323		ns
Read access time with pipeline register			0.323		0.38	ns
Read access time without pipeline register	T_{CLK2Q}		2.273		2.673	ns
Access time with feed-through write timing			1.511		1.778	ns
Address setup time	T_{ADDRSU}	0.543		0.638		ns
Address hold time	T_{ADDRHD}	0.274		0.322		ns
Data setup time	T_{DSU}	0.334		0.393		ns
Data hold time	T_{DHD}	0.082		0.096		ns
Block select setup time	T_{BLKSU}	0.207		0.244		ns
Block select hold time	T_{BLKHD}	0.216		0.254		ns
Block select to out disable time (when pipelined register is disabled)	T_{BLK2Q}		1.511		1.778	ns
Block select minimum pulse width	T_{BLKMPW}	0.186		0.219		ns
Read enable setup time	T_{RDESU}	0.516		0.607		ns
Read enable hold time	T_{RDEHD}	0.071		0.083		ns
Pipelined read enable setup time (A_DOUT_EN, B_DOUT_EN)	$T_{RDPLESU}$	0.248		0.291		ns
Pipelined read enable hold time (A_DOUT_EN, B_DOUT_EN)	$T_{RDPLEHD}$	0.102		0.12		ns
Asynchronous reset to output propagation delay	T_{R2Q}		1.507		1.773	ns
Asynchronous reset removal time	T_{RSTREM}	0.506		0.595		ns
Asynchronous reset recovery time	T_{RSTREC}	0.004		0.005		ns
Asynchronous reset minimum pulse width	T_{RSTMPW}	0.301		0.354		ns
Pipelined register asynchronous reset removal time	$T_{PLRSTREM}$	-0.279		-0.328		ns
Pipelined register asynchronous reset recovery time	$T_{PLRSTREC}$	0.327		0.385		ns
Pipelined register asynchronous reset minimum pulse width	$T_{PLRSTMPW}$	0.282		0.332		ns
Synchronous reset setup time	T_{SRSTSU}	0.226		0.265		ns
Synchronous reset hold time	T_{SRSTHD}	0.036		0.043		ns
Write enable setup time	T_{WESU}	0.458		0.539		ns
Write enable hold time	T_{WEHD}	0.048		0.057		ns
Maximum frequency	F_{MAX}		400		340	MHz

The following table lists the RAM1K18 – dual-port mode for depth × width configuration 8K × 2 in worst commercial-case conditions when $T_J = 85\text{ }^\circ\text{C}$, $V_{DD} = 1.14\text{ V}$.

Table 234 • RAM1K18 – Dual-Port Mode for Depth × Width Configuration 8K × 2

Parameter	Symbol	-1		-Std		Unit
		Min	Max	Min	Max	
Clock period	T_{CY}	2.5		2.941		ns
Clock minimum pulse width high	$T_{CLKMPWH}$	1.125		1.323		ns
Clock minimum pulse width low	$T_{CLKMPWL}$	1.125		1.323		ns
Pipelined clock period	T_{PLCY}	2.5		2.941		ns
Pipelined clock minimum pulse width high	$T_{PLCLKMPWH}$	1.125		1.323		ns
Pipelined clock minimum pulse width low	$T_{PLCLKMPWL}$	1.125		1.323		ns
Read access time with pipeline register				0.32	0.377	ns
Read access time without pipeline register	T_{CLK2Q}			2.272	2.673	ns
Access time with feed-through write timing				1.511	1.778	ns
Address setup time	T_{ADDRSU}	0.612		0.72		ns
Address hold time	T_{ADDRHD}	0.274		0.322		ns
Data setup time	T_{DSU}	0.33		0.388		ns
Data hold time	T_{DHD}	0.082		0.096		ns
Block select setup time	T_{BLKSU}	0.207		0.244		ns
Block select hold time	T_{BLKHD}	0.216		0.254		ns
Block select to out disable time (when pipelined register is disabled)	T_{BLK2Q}			1.511	1.778	ns
Block select minimum pulse width	T_{BLKMPW}	0.186		0.219		ns
Read enable setup time	T_{RDESU}	0.529		0.622		ns
Read enable hold time	T_{RDEHD}	0.071		0.083		ns
Pipelined read enable setup time (A_DOUT_EN, B_DOUT_EN)	$T_{RDPLESU}$	0.248		0.291		ns
Pipelined read enable hold time (A_DOUT_EN, B_DOUT_EN)	$T_{RDPLEHD}$	0.102		0.12		ns
Asynchronous reset to output propagation delay	T_{R2Q}			1.528	1.797	ns
Asynchronous reset removal time	T_{RSTREM}	0.506		0.595		ns
Asynchronous reset recovery time	T_{RSTREC}	0.004		0.005		ns
Asynchronous reset minimum pulse width	T_{RSTMPW}	0.301		0.354		ns
Pipelined register asynchronous reset removal time	$T_{PLRSTREM}$	-0.279		-0.328		ns
Pipelined register asynchronous reset recovery time	$T_{PLRSTREC}$	0.327		0.385		ns
Pipelined register asynchronous reset minimum pulse width	$T_{PLRSTMPW}$	0.282		0.332		ns
Synchronous reset setup time	T_{SRSTSU}	0.226		0.265		ns
Synchronous reset hold time	T_{SRSTHD}	0.036		0.043		ns
Write enable setup time	T_{WESU}	0.488		0.574		ns
Write enable hold time	T_{WEHD}	0.048		0.057		ns
Maximum frequency	F_{MAX}			400	340	MHz

The following table lists the RAM1K18 – dual-port mode for depth × width configuration 16K × 1 in worst commercial-case conditions when $T_J = 85\text{ }^\circ\text{C}$, $V_{DD} = 1.14\text{ V}$.

Table 235 • RAM1K18 – Dual-Port Mode for Depth × Width Configuration 16K × 1

Parameter	Symbol	–1		–Std		Unit
		Min	Max	Min	Max	
Clock period	T_{CY}	2.5		2.941		ns
Clock minimum pulse width high	$T_{CLKMPWH}$	1.125		1.323		ns
Clock minimum pulse width low	$T_{CLKMPWL}$	1.125		1.323		ns
Pipelined clock period	T_{PLCY}	2.5		2.941		ns
Pipelined clock minimum pulse width high	$T_{PLCLKMPWH}$	1.125		1.323		ns
Pipelined clock minimum pulse width low	$T_{PLCLKMPWL}$	1.125		1.323		ns
Read access time with pipeline register			0.32		0.377	ns
Read access time without pipeline register	T_{CLK2Q}		2.269		2.669	ns
Access time with feed-through write timing			1.51		1.777	ns
Address setup time	T_{ADDRSU}	0.626		0.737		ns
Address hold time	T_{ADDRHD}	0.274		0.322		ns
Data setup time	T_{DSU}	0.322		0.378		ns
Data hold time	T_{DHD}	0.082		0.096		ns
Block select setup time	T_{BLKSU}	0.207		0.244		ns
Block select hold time	T_{BLKHD}	0.216		0.254		ns
Block select to out disable time (when pipelined register is disabled)	T_{BLK2Q}		1.51		1.777	ns
Block select minimum pulse width	T_{BLKMPW}	0.186		0.219		ns
Read enable setup time	T_{RDESU}	0.53		0.624		ns
Read enable hold time	T_{RDEHD}	0.071		0.083		ns
Pipelined read enable setup time (A_DOUT_EN, B_DOUT_EN)	$T_{RDPLESU}$	0.248		0.291		ns
Pipelined read enable hold time (A_DOUT_EN, B_DOUT_EN)	$T_{RDPLEHD}$	0.102		0.12		ns
Asynchronous reset to output propagation delay	T_{R2Q}		1.547		1.82	ns
Asynchronous reset removal time	T_{RSTREM}	0.506		0.595		ns
Asynchronous reset recovery time	T_{RSTREC}	0.004		0.005		ns
Asynchronous reset minimum pulse width	T_{RSTMPW}	0.301		0.354		ns
Pipelined register asynchronous reset removal time	$T_{PLRSTREM}$	–0.279		–0.328		ns
Pipelined register asynchronous reset recovery time	$T_{PLRSTREC}$	0.327		0.385		ns
Pipelined register asynchronous reset minimum pulse width	$T_{PLRSTMPW}$	0.282		0.332		ns
Synchronous reset setup time	T_{SRSTSU}	0.226		0.265		ns
Synchronous reset hold time	T_{SRSTHD}	0.036		0.043		ns
Write enable setup time	T_{WESU}	0.454		0.534		ns
Write enable hold time	T_{WEHD}	0.048		0.057		ns
Maximum frequency	F_{MAX}		400		340	MHz

The following table lists the RAM1K18 – two-port mode for depth × width configuration 512 × 36 in worst commercial-case conditions when $T_J = 85\text{ }^\circ\text{C}$, $V_{DD} = 1.14\text{ V}$.

Table 236 • RAM1K18 – Two-Port Mode for Depth × Width Configuration 512 × 36

Parameter	Symbol	–1		–Std		Unit
		Min	Max	Min	Max	
Clock period	T_{CY}	2.5		2.941		ns
Clock minimum pulse width high	$T_{CLKMPWH}$	1.125		1.323		ns
Clock minimum pulse width low	$T_{CLKMPWL}$	1.125		1.323		ns
Pipelined clock period	T_{PLCY}	2.5		2.941		ns
Pipelined clock minimum pulse width high	$T_{PLCLKMPWH}$	1.125		1.323		ns
Pipelined clock minimum pulse width low	$T_{PLCLKMPWL}$	1.125		1.323		ns
Read access time with pipeline register	T_{CLK2Q}		0.334		0.393	ns
Read access time without pipeline register			2.25		2.647	ns
Address setup time	T_{ADDRSU}	0.313		0.368		ns
Address hold time	T_{ADDRHD}	0.274		0.322		ns
Data setup time	T_{DSU}	0.337		0.396		ns
Data hold time	T_{DHD}	0.111		0.13		ns
Block select setup time	T_{BLKSU}	0.207		0.244		ns
Block select hold time	T_{BLKHD}	0.201		0.237		ns
Block select to out disable time (when pipelined register is disabled)	T_{BLK2Q}		2.25		2.647	ns
Block select minimum pulse width	T_{BLKMPW}	0.186		0.219		ns
Read enable setup time	T_{RDESU}	0.449		0.528		ns
Read enable hold time	T_{RDEHD}	0.167		0.197		ns
Pipelined read enable setup time (A_DOUT_EN, B_DOUT_EN)	$T_{RDPLESU}$	0.248		0.291		ns
Pipelined read enable hold time (A_DOUT_EN, B_DOUT_EN)	$T_{RDPLEHD}$	0.102		0.12		ns
Asynchronous reset to output propagation delay	T_{R2Q}		1.506		1.772	ns
Asynchronous reset removal time	T_{RSTREM}	0.506		0.595		ns
Asynchronous reset recovery time	T_{RSTREC}	0.004		0.005		ns
Asynchronous reset minimum pulse width	T_{RSTMPW}	0.301		0.354		ns
Pipelined register asynchronous reset removal time	$T_{PLRSTREM}$	–0.279		–0.328		ns
Pipelined register asynchronous reset recovery time	$T_{PLRSTREC}$	0.327		0.385		ns
Pipelined register asynchronous reset minimum pulse width	$T_{PLRSTMPW}$	0.282		0.332		ns
Synchronous reset setup time	T_{SRSTSU}	0.226		0.265		ns
Synchronous reset hold time	T_{SRSTHD}	0.036		0.043		ns
Write enable setup time	T_{WESU}	0.39		0.458		ns
Write enable hold time	T_{WEHD}	0.242		0.285		ns
Maximum frequency	F_{MAX}		400		340	MHz

2.3.12.2 FPGA Fabric Micro SRAM (μ SRAM)

The following table lists the μ SRAM in 64×18 mode in worst commercial-case conditions when $T_J = 85^\circ\text{C}$, $V_{DD} = 1.14\text{ V}$.

Table 237 • μ SRAM (RAM64x18) in 64×18 Mode

Parameter	Symbol	-1		-Std		Unit
		Min	Max	Min	Max	
Read clock period	T_{CY}	4		4		ns
Read clock minimum pulse width high	$T_{CLKMPWH}$	1.8		1.8		ns
Read clock minimum pulse width low	$T_{CLKMPWL}$	1.8		1.8		ns
Read pipeline clock period	T_{PLCY}	4		4		ns
Read pipeline clock minimum pulse width high	$T_{PLCLKMPWH}$	1.8		1.8		ns
Read pipeline clock minimum pulse width low	$T_{PLCLKMPWL}$	1.8		1.8		ns
Read access time with pipeline register	T_{CLK2Q}		0.266		0.313	ns
Read access time without pipeline register				1.677		1.973
Read address setup time in synchronous mode	T_{ADDRSU}	0.301		0.354		ns
Read address setup time in asynchronous mode			1.856		2.184	
Read address hold time in synchronous mode	T_{ADDRHD}	0.091		0.107		ns
Read address hold time in asynchronous mode			-0.778		-0.915	
Read enable setup time	T_{RDENSU}	0.278		0.327		ns
Read enable hold time	T_{RDENHD}	0.057		0.067		ns
Read block select setup time	T_{BLKSU}	1.839		2.163		ns
Read block select hold time	T_{BLKHD}	-0.65		-0.765		ns
Read block select to out disable time (when pipelined register is disabled)	T_{BLK2Q}		2.036		2.396	ns
Read asynchronous reset removal time (pipelined clock)	T_{RSTREM}	-0.023		-0.027		ns
Read asynchronous reset removal time (non-pipelined clock)			0.046		0.054	
Read asynchronous reset recovery time (pipelined clock)	T_{RSTREC}	0.507		0.597		ns
Read asynchronous reset recovery time (non-pipelined clock)			0.236		0.278	
Read asynchronous reset to output propagation delay (with pipelined register enabled)	T_{R2Q}		0.839		0.987	ns
Read synchronous reset setup time	T_{SRSTSU}	0.271		0.319		ns
Read synchronous reset hold time	T_{SRSTHD}	0.061		0.071		ns
Write clock period	T_{CCY}	4		4		ns
Write clock minimum pulse width high	$T_{CCLKMPWH}$	1.8		1.8		ns
Write clock minimum pulse width low	$T_{CCLKMPWL}$	1.8		1.8		ns
Write block setup time	T_{BLKCSU}	0.404		0.476		ns
Write block hold time	T_{BLKCHD}	0.007		0.008		ns
Write input data setup time	T_{DINCSU}	0.115		0.135		ns
Write input data hold time	T_{DINCHD}	0.15		0.177		ns

Table 237 • μ SRAM (RAM64x18) in 64 × 18 Mode (continued)

Parameter	Symbol	-1		-Std		Unit
		Min	Max	Min	Max	
Write address setup time	$T_{ADDRCSU}$	0.088		0.104		ns
Write address hold time	$T_{ADDRCHD}$	0.128		0.15		ns
Write enable setup time	T_{WECSU}	0.397		0.467		ns
Write enable hold time	T_{WECHD}	-0.026		-0.03		ns
Maximum frequency	F_{MAX}		250		250	MHz

The following table lists the μ SRAM in 64 × 16 mode in worst commercial-case conditions when $T_J = 85\text{ }^\circ\text{C}$, $V_{DD} = 1.14\text{ V}$.

Table 238 • μ SRAM (RAM64x16) in 64 × 16 Mode

Parameter	Symbol	-1		-Std		Unit
		Min	Max	Min	Max	
Read clock period	T_{CY}	4		4		ns
Read clock minimum pulse width high	$T_{CLKMPWH}$	1.8		1.8		ns
Read clock minimum pulse width low	$T_{CLKMPWL}$	1.8		1.8		ns
Read pipeline clock period	T_{PLCY}	4		4		ns
Read pipeline clock minimum pulse width high	$T_{PLCLKMPWH}$	1.8		1.8		ns
Read pipeline clock minimum pulse width low	$T_{PLCLKMPWL}$	1.8		1.8		ns
Read access time with pipeline register	T_{CLK2Q}		0.266		0.313	ns
Read access time without pipeline register				1.677		1.973
Read address setup time in synchronous mode	T_{ADDRSU}	0.301		0.354		ns
Read address setup time in asynchronous mode			1.856		2.184	
Read address hold time in synchronous mode	T_{ADDRHD}	0.091		0.107		ns
Read address hold time in asynchronous mode			-0.778		-0.915	
Read enable setup time	T_{RDENSU}	0.278		0.327		ns
Read enable hold time	T_{RDENHD}	0.057		0.067		ns
Read block select setup time	T_{BLKSU}	1.839		2.163		ns
Read block select hold time	T_{BLKHD}	-0.65		-0.765		ns
Read block select to out disable time (when pipelined register is disabled)	T_{BLK2Q}		2.036		2.396	ns
Read asynchronous reset removal time (pipelined clock)	T_{RSTREM}	-0.023		-0.027		ns
Read asynchronous reset removal time (non-pipelined clock)			0.046		0.054	
Read asynchronous reset recovery time (pipelined clock)	T_{RSTREC}	0.507		0.597		ns
Read asynchronous reset recovery time (non-pipelined clock)			0.236		0.278	
Read asynchronous reset to output propagation delay (with pipelined register enabled)	T_{R2Q}		0.835		0.983	ns
Read synchronous reset setup time	T_{SRSTSU}	0.271		0.319		ns

Table 238 • μ SRAM (RAM64x16) in 64 x 16 Mode (continued)

Parameter	Symbol	-1		-Std		Unit
		Min	Max	Min	Max	
Read synchronous reset hold time	T_{SRSTHD}	0.061		0.071		ns
Write clock period	T_{CCY}	4		4		ns
Write clock minimum pulse width high	$T_{CCLKMPWH}$	1.8		1.8		ns
Write clock minimum pulse width low	$T_{CCLKMPWL}$	1.8		1.8		ns
Write block setup time	T_{BLKCSU}	0.404		0.476		ns
Write block hold time	T_{BLKCHD}	0.007		0.008		ns
Write input data setup time	T_{DINCSU}	0.115		0.135		ns
Write input data hold time	T_{DINCHD}	0.15		0.177		ns
Write address setup time	$T_{ADDRCSU}$	0.088		0.104		ns
Write address hold time	$T_{ADDRCHD}$	0.128		0.15		ns
Write enable setup time	T_{WECSU}	0.397		0.467		ns
Write enable hold time	T_{WECHD}	-0.026		-0.03		ns
Maximum frequency	F_{MAX}		250		250	MHz

The following table lists the μ SRAM in 128 x 9 mode in worst commercial-case conditions when $T_J = 85^\circ\text{C}$, $V_{DD} = 1.14\text{ V}$.

Table 239 • μ SRAM (RAM128x9) in 128 x 9 Mode

Parameter	Symbol	-1		-Std		Unit
		Min	Max	Min	Max	
Read clock period	T_{CY}	4		4		ns
Read clock minimum pulse width high	$T_{CLKMPWH}$	1.8		1.8		ns
Read clock minimum pulse width low	$T_{CLKMPWL}$	1.8		1.8		ns
Read pipeline clock period	T_{PLCY}	4		4		ns
Read pipeline clock minimum pulse width high	$T_{PLCLKMPWH}$	1.8		1.8		ns
Read pipeline clock minimum pulse width low	$T_{PLCLKMPWL}$	1.8		1.8		ns
Read access time with pipeline register	T_{CLK2Q}		0.266		0.313	ns
Read access time without pipeline register				1.677		1.973
Read address setup time in synchronous mode	T_{ADDRSU}	0.301		0.354		ns
Read address setup time in asynchronous mode			1.856		2.184	
Read address hold time in synchronous mode	T_{ADDRHD}	0.091		0.107		ns
Read address hold time in asynchronous mode			-0.778		-0.915	
Read enable setup time	T_{RDENSU}	0.278		0.327		ns
Read enable hold time	T_{RDENHD}	0.057		0.067		ns
Read block select setup time	T_{BLKSU}	1.839		2.163		ns
Read block select hold time	T_{BLKHD}	-0.65		-0.765		ns
Read block select to out disable time (when pipelined register is disabled)	T_{BLK2Q}		2.036		2.396	ns

Table 239 • μ SRAM (RAM128x9) in 128 × 9 Mode (continued)

Parameter	Symbol	-1		-Std		Unit
		Min	Max	Min	Max	
Read asynchronous reset removal time (pipelined clock)		-0.023		-0.027		ns
Read asynchronous reset removal time (non-pipelined clock)	T_{RSTREM}	0.046		0.054		ns
Read asynchronous reset recovery time (pipelined clock)		0.507		0.597		ns
Read asynchronous reset recovery time (non-pipelined clock)	T_{RSTREC}	0.236		0.278		ns
Read asynchronous reset to output propagation delay (with pipelined register enabled)	T_{R2Q}		0.835		0.982	ns
Read synchronous reset setup time	T_{SRSTSU}	0.271		0.319		ns
Read synchronous reset hold time	T_{SRSTHD}	0.061		0.071		ns
Write clock period	T_{CCY}	4		4		ns
Write clock minimum pulse width high	$T_{CCLKMPWH}$	1.8		1.8		ns
Write clock minimum pulse width low	$T_{CCLKMPWL}$	1.8		1.8		ns
Write block setup time	T_{BLKCSU}	0.404		0.476		ns
Write block hold time	T_{BLKCHD}	0.007		0.008		ns
Write input data setup time	T_{DINCSU}	0.115		0.135		ns
Write input data hold time	T_{DINCHD}	0.15		0.177		ns
Write address setup time	$T_{ADDRCSU}$	0.088		0.104		ns
Write address hold time	$T_{ADDRCHD}$	0.128		0.15		ns
Write enable setup time	T_{WECSU}	0.397		0.467		ns
Write enable hold time	T_{WECHD}	-0.026		-0.03		ns
Maximum frequency	F_{MAX}		250		250	MHz

The following table lists the μ SRAM in 128 × 8 mode in worst commercial-case conditions when $T_J = 85^\circ\text{C}$, $V_{DD} = 1.14\text{ V}$.

Table 240 • μ SRAM (RAM128x8) in 128 × 8 Mode

Parameter	Symbol	-1		-Std		Unit
		Min	Max	Min	Max	
Read clock period	T_{CY}	4		4		ns
Read clock minimum pulse width high	$T_{CLKMPWH}$	1.8		1.8		ns
Read clock minimum pulse width low	$T_{CLKMPWL}$	1.8		1.8		ns
Read pipeline clock period	T_{PLCY}	4		4		ns
Read pipeline clock minimum pulse width high	$T_{PLCLKMPWH}$	1.8		1.8		ns
Read pipeline clock minimum pulse width low	$T_{PLCLKMPWL}$	1.8		1.8		ns
Read access time with pipeline register			0.266		0.313	ns
Read access time without pipeline register	T_{CLK2Q}		1.677		1.973	ns
Read address setup time in synchronous mode		0.301		0.354		ns
Read address setup time in asynchronous mode	T_{ADDRSU}	1.856		2.184		ns

Table 240 • μ SRAM (RAM128x8) in 128 x 8 Mode (continued)

Parameter	Symbol	-1		-Std		Unit
		Min	Max	Min	Max	
Read address hold time in synchronous mode	T_{ADDRHD}	0.091		0.107		ns
Read address hold time in asynchronous mode		-0.778		-0.915		ns
Read enable setup time	T_{RDENSU}	0.278		0.327		ns
Read enable hold time	T_{RDENHD}	0.057		0.067		ns
Read block select setup time	T_{BLKSU}	1.839		2.163		ns
Read block select hold time	T_{BLKHD}	-0.65		-0.765		ns
Read block select to out disable time (when pipelined register is disabled)	T_{BLK2Q}		2.036		2.396	ns
Read asynchronous reset removal time (pipelined clock)	T_{RSTREM}	-0.023		-0.027		ns
Read asynchronous reset removal time (non-pipelined clock)		0.046		0.054		ns
Read asynchronous reset recovery time (pipelined clock)	T_{RSTREC}	0.507		0.597		ns
Read asynchronous reset recovery time (non-pipelined clock)		0.236		0.278		ns
Read asynchronous reset to output propagation delay (with pipelined register enabled)	T_{R2Q}		0.835		0.982	ns
Read synchronous reset setup time	T_{SRSTSU}	0.271		0.319		ns
Read synchronous reset hold time	T_{SRSTHD}	0.061		0.071		ns
Write clock period	T_{CCY}	4		4		ns
Write clock minimum pulse width high	$T_{CCLKMPWH}$	1.8		1.8		ns
Write clock minimum pulse width low	$T_{CCLKMPWL}$	1.8		1.8		ns
Write block setup time	T_{BLKCSU}	0.404		0.476		ns
Write block hold time	T_{BLKCHD}	0.007		0.008		ns
Write input data setup time	T_{DINCSU}	0.115		0.135		ns
Write input data hold time	T_{DINCHD}	0.15		0.177		ns
Write address setup time	$T_{ADDRCSU}$	0.088		0.104		ns
Write address hold time	$T_{ADDRCHD}$	0.128		0.15		ns
Write enable setup time	T_{WECSU}	0.397		0.467		ns
Write enable hold time	T_{WECHD}	-0.026		-0.03		ns
Maximum frequency	F_{MAX}		250		250	MHz

The following table lists the μ SRAM in 256×4 mode in worst commercial-case conditions when $T_J = 85^\circ\text{C}$, $V_{DD} = 1.14\text{ V}$.

Table 241 • μ SRAM (RAM256x4) in 256×4 Mode

Parameter	Symbol	-1		-Std		Unit
		Min	Max	Min	Max	
Read clock period	T_{CY}	4		4		ns
Read clock minimum pulse width high	$T_{CLKMPWH}$	1.8		1.8		ns
Read clock minimum pulse width low	$T_{CLKMPWL}$	1.8		1.8		ns
Read pipeline clock period	T_{PLCY}	4		4		ns
Read pipeline clock minimum pulse width high	$T_{PLCLKMPWH}$	1.8		1.8		ns
Read pipeline clock minimum pulse width low	$T_{PLCLKMPWL}$	1.8		1.8		ns
Read access time with pipeline register	T_{CLK2Q}		0.27		0.31	ns
Read access time without pipeline register			1.75		2.06	ns
Read address setup time in synchronous mode	T_{ADDRSU}	0.301		0.354		ns
Read address setup time in asynchronous mode			1.931		2.272	ns
Read address hold time in synchronous mode	T_{ADDRHD}	0.121		0.142		ns
Read address hold time in asynchronous mode			-0.65		-0.76	ns
Read enable setup time	T_{RDENSU}	0.278		0.327		ns
Read enable hold time	T_{RDENHD}	0.057		0.067		ns
Read block select setup time	T_{BLKSU}	1.839		2.163		ns
Read block select hold time	T_{BLKHD}	-0.65		-0.77		ns
Read block select to out disable time (when pipelined register is disabled)	T_{BLK2Q}		2.09		2.46	ns
Read asynchronous reset removal time (pipelined clock)	T_{RSTREM}	-0.02		-0.03		ns
Read asynchronous reset removal time (non-pipelined clock)			0.046		0.054	ns
Read asynchronous reset recovery time (pipelined clock)	T_{RSTREC}	0.507		0.597		ns
Read asynchronous reset recovery time (non-pipelined clock)			0.236		0.278	ns
Read asynchronous reset to output propagation delay (with pipelined register enabled)	T_{R2Q}		0.83		0.98	ns
Read synchronous reset setup time	T_{SRSTSU}	0.271		0.319		ns
Read synchronous reset hold time	T_{SRSTHD}	0.061		0.071		ns
Write clock period	T_{CCY}	4		4		ns
Write clock minimum pulse width high	$T_{CCLKMPWH}$	1.8		1.8		ns
Write clock minimum pulse width low	$T_{CCLKMPWL}$	1.8		1.8		ns
Write block setup time	T_{BLKCSU}	0.404		0.476		ns
Write block hold time	T_{BLKCHD}	0.007		0.008		ns
Write input data setup time	T_{DINCSU}	0.101		0.118		ns
Write input data hold time	T_{DINCHD}	0.137		0.161		ns
Write address setup time	$T_{ADDRCSU}$	0.088		0.104		ns

Table 241 • μ SRAM (RAM256x4) in 256 x 4 Mode (continued)

Parameter	Symbol	-1		-Std		Unit
		Min	Max	Min	Max	
Write address hold time	$T_{ADDRCHD}$	0.245		0.288		ns
Write enable setup time	T_{WECSU}	0.397		0.467		ns
Write enable hold time	T_{WECHD}	-0.03		-0.03		ns
Maximum frequency	F_{MAX}		250		250	MHz

The following table lists the μ SRAM in 512 x 2 mode in worst commercial-case conditions when $T_J = 85^\circ\text{C}$, $V_{DD} = 1.14\text{ V}$.

Table 242 • μ SRAM (RAM512x2) in 512 x 2 Mode

Parameter	Symbol	-1		-Std		Unit
		Min	Max	Min	Max	
Read clock period	T_{CY}	4		4		ns
Read clock minimum pulse width high	$T_{CLKMPWH}$	1.8		1.8		ns
Read clock minimum pulse width low	$T_{CLKMPWL}$	1.8		1.8		ns
Read pipeline clock period	T_{PLCY}	4		4		ns
Read pipeline clock minimum pulse width high	$T_{PLCLKMPWH}$	1.8		1.8		ns
Read pipeline clock minimum pulse width low	$T_{PLCLKMPWL}$	1.8		1.8		ns
Read access time with pipeline register	T_{CLK2Q}		0.27		0.31	ns
Read access time without pipeline register				1.76		2.08
Read address setup time in synchronous mode	T_{ADDRSU}	0.301		0.354		ns
Read address setup time in asynchronous mode			1.96		2.306	
Read address hold time in synchronous mode	T_{ADDRHD}	0.137		0.161		ns
Read address hold time in asynchronous mode			-0.58		-0.68	
Read enable setup time	T_{RDENSU}	0.278		0.327		ns
Read enable hold time	T_{RDENHD}	0.057		0.067		ns
Read block select setup time	T_{BLKSU}	1.839		2.163		ns
Read block select hold time	T_{BLKHD}	-0.65		-0.77		ns
Read block select to out disable time (when pipelined register is disabled)	T_{BLK2Q}		2.14		2.52	ns
Read asynchronous reset removal time (pipelined clock)	T_{RSTREM}	-0.02		-0.03		ns
Read asynchronous reset removal time (non-pipelined clock)			0.046		0.054	
Read asynchronous reset recovery time (pipelined clock)	T_{RSTREC}	0.507		0.597		ns
Read asynchronous reset recovery time (non-pipelined clock)			0.236		0.278	
Read asynchronous reset to output propagation delay (with pipelined register enabled)	T_{R2Q}		0.83		0.98	ns
Read synchronous reset setup time	T_{SRSTSU}	0.271		0.319		ns
Read synchronous reset hold time	T_{SRSTHD}	0.061		0.071		ns

Table 242 • μ SRAM (RAM512x2) in 512 x 2 Mode (continued)

Parameter	Symbol	-1		-Std		Unit
		Min	Max	Min	Max	
Write clock period	T_{CCY}	4		4		ns
Write clock minimum pulse width high	$T_{CCLKMPWH}$	1.8		1.8		ns
Write clock minimum pulse width low	$T_{CCLKMPWL}$	1.8		1.8		ns
Write block setup time	T_{BLKCSU}	0.404		0.476		ns
Write block hold time	T_{BLKCHD}	0.007		0.008		ns
Write input data setup time	T_{DINCSU}	0.101		0.118		ns
Write input data hold time	T_{DINCHD}	0.137		0.161		ns
Write address setup time	$T_{ADDRCSU}$	0.088		0.104		ns
Write address hold time	$T_{ADDRCHD}$	0.247		0.29		ns
Write enable setup time	T_{WECSU}	0.397		0.467		ns
Write enable hold time	T_{WECHD}	-0.03		-0.03		ns
Maximum frequency	F_{MAX}		250		250	MHz

The following table lists the μ SRAM in 1024 x 1 mode in worst commercial-case conditions when $T_J = 85^\circ\text{C}$, $V_{DD} = 1.14\text{ V}$.

Table 243 • μ SRAM (RAM1024x1) in 1024 x 1 Mode

Parameter	Symbol	-1		-Std		Unit
		Min	Max	Min	Max	
Read clock period	T_{CY}	4		4		ns
Read clock minimum pulse width high	$T_{CLKMPWH}$	1.8		1.8		ns
Read clock minimum pulse width low	$T_{CLKMPWL}$	1.8		1.8		ns
Read pipeline clock period	T_{PLCY}	4		4		ns
Read pipeline clock minimum pulse width high	$T_{PLCLKMPWH}$	1.8		1.8		ns
Read pipeline clock minimum pulse width low	$T_{PLCLKMPWL}$	1.8		1.8		ns
Read access time with pipeline register	T_{CLK2Q}		0.27		0.31	ns
Read access time without pipeline register				1.78		2.1
Read address setup time in synchronous mode	T_{ADDRSU}	0.301		0.354		ns
Read address setup time in asynchronous mode			1.978		2.327	
Read address hold time in synchronous mode	T_{ADDRHD}	0.137		0.161		ns
Read address hold time in asynchronous mode			-0.6		-0.71	
Read enable setup time	T_{RDENSU}	0.278		0.327		ns
Read enable hold time	T_{RDENHD}	0.057		0.067		ns
Read block select setup time	T_{BLKSU}	1.839		2.163		ns
Read block select hold time	T_{BLKHHD}	-0.65		-0.77		ns
Read block select to out disable time (when pipelined register is disabled)	T_{BLK2Q}		2.16		2.54	ns
Read asynchronous reset removal time (pipelined clock)	T_{RSTREM}		-0.02		-0.03	ns
Read asynchronous reset removal time (non-pipelined clock)			0.046		0.054	

Table 243 • μ SRAM (RAM1024x1) in 1024 x 1 Mode (continued)

Parameter	Symbol	-1		-Std		Unit
		Min	Max	Min	Max	
Read asynchronous reset recovery time (pipelined clock)	T_{RSTREC}	0.507		0.597		ns
Read asynchronous reset recovery time (non-pipelined clock)		0.236		0.278		ns
Read asynchronous reset to output propagation delay (with pipelined register enabled)	T_{R2Q}		0.83		0.98	ns
Read synchronous reset setup time	T_{SRSTSU}	0.271		0.319		ns
Read synchronous reset hold time	T_{SRSTHD}	0.061		0.071		ns
Write clock period	T_{CCY}	4		4		ns
Write clock minimum pulse width high	$T_{CCLKMPWH}$	1.8		1.8		ns
Write clock minimum pulse width low	$T_{CCLKMPWL}$	1.8		1.8		ns
Write block setup time	T_{BLKCSU}	0.404		0.476		ns
Write block hold time	T_{BLKCHD}	0.007		0.008		ns
Write input data setup time	T_{DINCSU}	0.003		0.004		ns
Write input data hold time	T_{DINCHD}	0.137		0.161		ns
Write address setup time	$T_{ADDRCSU}$	0.088		0.104		ns
Write address hold time	$T_{ADDRCHD}$	0.247		0.29		ns
Write enable setup time	T_{WECSU}	0.397		0.467		ns
Write enable hold time	T_{WECHD}	-0.03		-0.03		ns
Maximum frequency	F_{MAX}		250		250	MHz

2.3.13 Programming Times

The following tables list the programming times in typical conditions when $T_J = 25\text{ }^\circ\text{C}$, $V_{DD} = 1.2\text{ V}$. External SPI flash part# AT25DF641-s3H is used during this measurement.

Table 244 • JTAG Programming (Fabric Only)

M2S/M2GL				
Device	Image size Bytes	Program	Verify	Unit
005	302672	22	10	Sec
010	568784	28	18	Sec
025	1223504	51	26	Sec
050	2424832	66	54	Sec
060	2418896	77	54	Sec
090	3645968	113	126	Sec
150	6139184	155	193	Sec

Table 245 • JTAG Programming (eNVM Only)

M2S/M2GL				
Device	Image size Bytes	Program	Verify	Unit
005	137536	39	4	Sec
010	274816	78	9	Sec
025	274816	78	9	Sec
050	278528	84	8	Sec
060	268480	76	8	Sec
090	544496	154	15	Sec
150	544496	155	15	Sec

Table 246 • JTAG Programming (Fabric and eNVM)

M2S/M2GL				
Device	Image size Bytes	Program	Verify	Unit
005	439296	59	11	Sec
010	842688	107	20	Sec
025	1497408	120	35	Sec
050	2695168	162	59	Sec
060	2686464	158	70	Sec
090	4190208	266	147	Sec
150	6682768	316	231	Sec

Table 247 • 2 Step IAP Programming (Fabric Only)

M2S/M2GL					
Device	Image size Bytes	Authenticate	Program	Verify	Unit
005	302672	4	17	6	Sec
010	568784	7	23	12	Sec
025	1223504	14	33	23	Sec
050	2424832	29	52	40	Sec
060	2418896	39	61	50	Sec
090	3645968	60	84	73	Sec
150	6139184	100	132	120	Sec

Table 248 • 2 Step IAP Programming (eNVM Only)

M2S/M2GL					
Device	Image size Bytes	Authenticate	Program	Verify	Unit
005	137536	2	37	5	Sec
010	274816	4	76	11	Sec
025	274816	4	78	10	Sec
050	278528	3	85	9	Sec
060	268480	5	76	22	Sec
090	544496	10	152	43	Sec
150	544496	10	153	44	Sec

Table 249 • 2 Step IAP Programming (Fabric and eNVM)

M2S/M2GL					
Device	Image size Bytes	Authenticate	Program	Verify	Unit
005	439296	6	56	11	Sec
010	842688	11	100	21	Sec
025	1497408	19	113	32	Sec
050	2695168	32	136	48	Sec
060	2686464	43	137	70	Sec
090	4190208	68	236	115	Sec
150	6682768	109	286	162	Sec

Table 250 • SmartFusion2 Cortex-M3 ISP Programming (Fabric Only)

M2S/M2GL					
Device	Image size Bytes	Authenticate	Program	Verify	Unit
005	302672	6	19	8	Sec
010	568784	10	26	14	Sec
025	1223504	21	39	29	Sec
050	2424832	39	60	50	Sec
060	2418896	44	65	54	Sec
090	3645968	66	90	79	Sec
150	6139184	108	140	128	Sec

Table 251 • SmartFusion2 Cortex-M3 ISP Programming (eNVM Only)

M2S/M2GL					
Device	Image size Bytes	Authenticate	Program	Verify	Unit
005	137536	3	42	4	Sec
010	274816	4	82	7	Sec
025	274816	4	82	8	Sec
050	278528	4	80	8	Sec
060	268480	6	80	8	Sec
090	544496	10	157	15	Sec

Table 251 • SmartFusion2 Cortex-M3 ISP Programming (eNVM Only) (continued)

M2S/M2GL Device	Image size Bytes	Authenticate	Program	Verify	Unit
150	544496	10	158	15	Sec

Table 252 • SmartFusion2 Cortex-M3 ISP Programming (Fabric and eNVM)

M2S/M2GL Device	Image size Bytes	Authenticate	Program	Verify	Unit
005	439296	9	61	11	Sec
010	842688	15	107	21	Sec
025	1497408	26	121	35	Sec
050	2695168	43	141	55	Sec
060	2686464	48	143	60	Sec
090	4190208	75	244	91	Sec
150	6682768	117	296	141	Sec

Table 253 • Programming Times with 100 kHz, 25 MHz, and 12.5 MHz SPI Clock Rates (Fabric Only)

M2S/M2GL Device	Auto Programming	Auto Update	Programming Recovery	Unit
	100 kHz	25 MHz	12.5 MHz	
005	47	27	28	Sec
010	77	35	35	Sec
025	150	42	41	Sec
050	33 ¹	Not Supported	Not Supported	Sec
060	291	83	82	Sec
090	427	109	108	Sec
150	708	157	160	Sec

1. Auto Programming in 050 device is done through SC_SPI, and SPI CLK is set to 6.25 MHz.

Table 254 • Programming Times with 100 kHz, 25 MHz, and 12.5 MHz SPI Clock Rates (eNVM Only)

M2S/M2GL Device	Auto Programming	Auto Update	Programming Recovery	Unit
	100 kHz	25 MHz	12.5 MHz	
005	41	48	49	Sec
010	86	87	87	Sec
025	87	85	86	Sec
050	85	Not Supported	Not Supported	Sec
060	78	86	86	Sec
090	154	162	162	Sec

Table 254 • Programming Times with 100 kHz, 25 MHz, and 12.5 MHz SPI Clock Rates (eNVM Only) (continued)

M2S/M2GL Device	Auto Programming	Auto Update	Programming Recovery	Unit
	100 kHz	25 MHz	12.5 MHz	
150	161	161	161	Sec

Table 255 • Programming Times with 100 kHz, 25 MHz, and 12.5 MHz SPI Clock Rates (Fabric and eNVM)

M2S/M2GL Device	Auto Programming	Auto Update	Programming Recovery	Unit
	100 kHz	25 MHz	12.5 MHz	
005	47	27	28	Sec
010	77	35	35	Sec
025	150	42	41	Sec
050	33 ¹	Not Supported	Not Supported	Sec
060	291	83	82	Sec
090	427	109	108	Sec
150	708	157	160	Sec
005	41	48	49	Sec
010	86	87	87	Sec
025	87	85	86	Sec
050	85	Not Supported	Not Supported	Sec
060	78	86	86	Sec
090	154	162	162	Sec
150	161	161	161	Sec
005	87	67	66	Sec
010	161	113	113	Sec
025	229	120	121	Sec
050	112	Not Supported	Not Supported	Sec
060	368	161	158	Sec
090	582	261	260	Sec
150	867	309	310	Sec

1. Auto Programming in 050 device is done through SC_SPI, and SPI CLK is set to 6.25 MHz.

The following table lists the programming times in worst-case conditions when $T_J = 100\text{ }^\circ\text{C}$, $V_{DD} = 1.14\text{ V}$. External SPI flash part# AT25DF641-s3H is used during this measurement.

Table 256 • JTAG Programming (Fabric Only)

M2S/M2GL Device	Image size		Verify	Unit
	Bytes	Program		
005	302672	44	10	Sec
010	568784	50	18	Sec
025	1223504	73	26	Sec
050	2424832	88	54	Sec
060	2418896	99	54	Sec
090	3645968	135	126	Sec
150	6139184	177	193	Sec

Table 257 • JTAG Programming (eNVM Only)

M2S/M2GL Device	Image size		Verify	Unit
	Bytes	Program		
005	137536	61	4	Sec
010	274816	100	9	Sec
025	274816	100	9	Sec
050	2,78,528	106	8	Sec
060	268480	98	8	Sec
090	544496	176	15	Sec
150	544496	177	15	Sec

Table 258 • JTAG Programming (Fabric and eNVM)

M2S/M2GL Device	Image size		Verify	Unit
	Bytes	Program		
005	439296	71	11	Sec
010	842688	129	20	Sec
025	1497408	142	35	Sec
050	2695168	184	59	Sec
060	2686464	180	70	Sec
090	4190208	288	147	Sec
150	6682768	338	231	Sec

Table 259 • 2 Step IAP Programming (Fabric Only)

M2S/M2GL Device	Image size		Authenticate	Program	Verify	Unit
	Bytes					
005	302672	4	39	6	Sec	
010	568784	7	45	12	Sec	
025	1223504	14	55	23	Sec	
050	2424832	29	74	40	Sec	
060	2418896	39	83	50	Sec	
090	3645968	60	106	73	Sec	
150	6139184	100	154	120	Sec	

Table 260 • 2 Step IAP Programming (eNVM Only)

M2S/M2GL Device	Image size		Authenticate	Program	Verify	Unit
	Bytes					
005	137536	2	59	5	Sec	
010	274816	4	98	11	Sec	
025	274816	4	100	10	Sec	
050	2,78,528	3	107	9	Sec	
060	268480	5	98	22	Sec	
090	544496	10	174	43	Sec	
150	544496	10	175	44	Sec	

Table 261 • 2 Step IAP Programming (Fabric and eNVM)

M2S/M2GL Device	Image size		Authenticate	Program	Verify	Unit
	Bytes					
005	439296	6	78	11	Sec	
010	842688	11	122	21	Sec	
025	1497408	19	135	32	Sec	
050	2695168	32	158	48	Sec	
060	2686464	43	159	70	Sec	
090	4190208	68	258	115	Sec	
150	6682768	109	308	162	Sec	

Table 262 • SmartFusion2 Cortex-M3 ISP Programming (Fabric Only)

M2S/M2GL Device	Image size Bytes	Authenticate	Program	Verify	Unit
005	302672	6	41	8	Sec
010	568784	10	48	14	Sec
025	1223504	21	61	29	Sec
050	2424832	39	82	50	Sec
060	2418896	44	87	54	Sec
090	3645968	66	112	79	Sec
150	6139184	108	162	128	Sec

Table 263 • SmartFusion2 Cortex-M3 ISP Programming (eNVM Only)

M2S/M2GL Device	Image size Bytes	Authenticate	Program	Verify	Unit
005	137536	3	64	4	Sec
010	274816	4	104	7	Sec
025	274816	4	104	8	Sec
050	2,78,528	4	102	8	Sec
060	268480	6	102	8	Sec
090	544496	10	179	15	Sec
150	544496	10	180	15	Sec

Table 264 • SmartFusion2 Cortex-M3 ISP Programming (Fabric and eNVM)

M2S/M2GL Device	Image size Bytes	Authenticate	Program	Verify	Unit
005	439296	9	83	11	Sec
010	842688	15	129	21	Sec
025	1497408	26	143	35	Sec
050	2695168	43	163	55	Sec
060	2686464	48	165	60	Sec
090	4190208	75	266	91	Sec
150	6682768	117	318	141	Sec

Table 265 • Programming Times with 100 kHz, 25 MHz, and 12.5 MHz SPI Clock Rates (Fabric Only)

M2S/M2GL Device	Auto Programming			Unit
	100 kHz	25 MHz	12.5 MHz	
005	69	49	50	Sec
010	99	57	57	Sec
025	150	64	63	Sec
050	55 ¹	Not Supported	Not Supported	Sec
060	313	105	104	Sec
090	449	131	130	Sec
150	730	179	183	Sec

1. Auto programming in 050 device is done through SC_SPI, and SPI CLK is set to 6.25 MHz.

Table 266 • Programming Times with 100 kHz, 25 MHz, and 12.5 MHz SPI Clock Rates (eNVM Only)

M2S/M2GL Device	Auto Programming			Unit
	100 kHz	25 MHz	12.5 MHz	
005	63	70	71	Sec
010	108	109	109	Sec
025	109	107	108	Sec
050	107	Not Supported	Not Supported	Sec
060	100	108	108	Sec
090	176	184	184	Sec
150	183	183	183	Sec

Table 267 • Programming Times with 100 kHz, 25 MHz, and 12.5 MHz SPI Clock Rates (Fabric and eNVM)

M2S/M2GL Device	Auto Programming			Unit
	100 kHz	25 MHz	12.5 MHz	
005	109	89	88	Sec
010	183	135	135	Sec
025	251	142	143	Sec
050	134	Not Supported	Not Supported	Sec
060	390	183	180	Sec
090	604	283	282	Sec
150	889	331	332	Sec

2.3.14 Math Block Timing Characteristics

The fundamental building block in any digital signal processing algorithm is the multiply-accumulate function. Each IGLOO2 and SmartFusion2 SoC math block supports 18×18 signed multiplication, dot product, and built-in addition, subtraction, and accumulation units to combine multiplication results efficiently. The following table lists the math blocks with all registers used in worst commercial-case conditions when $T_J = 85\text{ }^\circ\text{C}$, $V_{DD} = 1.14\text{ V}$.

Table 268 • Math Blocks with all Registers Used

Parameter	Symbol	-1		-Std		Unit
		Min	Max	Min	Max	
Input, control register setup time	T_{MISU}	0.149		0.176		ns
Input, control register hold time	T_{MIHD}	1.68		1.976		ns
CDIN input setup time	$T_{MOCDINSU}$	0.185		0.218		ns
CDIN input hold time	$T_{MOCDINHHD}$	0.08		0.094		ns
Synchronous reset/enable setup time	$T_{MSRSTENSU}$	-0.419		-0.493		ns
Synchronous reset/enable hold time	$T_{MSRSTENHD}$	0.011		0.013		ns
Asynchronous reset removal time	$T_{MARSTREM}$	0		0		ns
Asynchronous reset recovery time	$T_{MARSTREC}$	0.088		0.104		ns
Output register clock to out delay	T_{MOCQ}		0.232		0.273	ns
CLK minimum period	T_{MCLKMP}	2.245		2.641		ns

The following table lists the math blocks with input bypassed and output registers used in worst commercial-case conditions when $T_J = 85\text{ }^\circ\text{C}$, $V_{DD} = 1.14\text{ V}$.

Table 269 • Math Block with Input Bypassed and Output Registers Used

Parameter	Symbol	-1		-Std		Unit
		Min	Max	Min	Max	
Output register setup time	T_{MOSU}	2.294		2.699		ns
Output register hold time	T_{MOHD}	1.68		1.976		ns
CDIN input setup time	$T_{MOCDINSU}$	0.115		0.136		ns
CDIN input hold time	$T_{MOCDINHHD}$	-0.444		-0.522		ns
Synchronous reset/enable setup time	$T_{MSRSTENSU}$	-0.419		-0.493		ns
Synchronous reset/enable hold time	$T_{MSRSTENHD}$	0.011		0.013		ns
Asynchronous reset removal time	$T_{MARSTREM}$	0		0		ns
Asynchronous reset recovery time	$T_{MARSTREC}$	0.014		0.017		ns
Output register clock to out delay	T_{MOCQ}		0.232		0.273	ns
CLK minimum period	T_{MCLKMP}	2.179		2.563		ns

The following table lists the math blocks with input register used and output in bypass mode in worst commercial-case conditions when $T_J = 85\text{ }^\circ\text{C}$, $V_{DD} = 1.14\text{ V}$.

Table 270 • Math Block with Input Register Used and Output in Bypass Mode

Parameter	Symbol	-1		-Std		Unit
		Min	Max	Min	Max	
Input register setup time	T_{MISU}	0.149		0.176		ns
Input register hold time	T_{MIHD}	0.185		0.218		ns
Synchronous reset/enable setup time	$T_{MSRSTENSU}$	0.08		0.094		ns
Synchronous reset/enable hold time	$T_{MSRSTENHD}$	-0.012		-0.014		ns
Asynchronous reset removal time	$T_{MARSTREM}$	-0.005		-0.005		ns
Asynchronous reset recovery time	$T_{MARSTREC}$	0.088		0.104		ns
Input register clock to output delay	T_{MICQ}		2.52		2.964	ns
CDIN to output delay	$T_{MCDIN2Q}$		1.951		2.295	ns

The following table lists the math blocks with input and output in bypass mode in worst commercial-case conditions when $T_J = 85\text{ }^\circ\text{C}$, $V_{DD} = 1.14\text{ V}$.

Table 271 • Math Block with Input and Output in Bypass Mode

Parameter	Symbol	-1	-Std	Unit
		Max	Max	
Input to output delay	T_{MIQ}	2.568	3.022	ns
CDIN to output delay	$T_{MCDIN2Q}$	1.951	2.295	ns

2.3.15 Embedded NVM (eNVM) Characteristics

The following table lists the eNVM read performance in worst-case conditions when $V_{DD} = 1.14\text{ V}$, $V_{PPNVM} = V_{PP} = 2.375\text{ V}$.

Table 272 • eNVM Read Performance

Symbol	Description	Operating Temperature Range						Unit
		-1	-Std	-1	-Std	-1	-Std	
T_J	Junction temperature range	-55 °C to 125 °C		-40 °C to 100 °C		0 °C to 85 °C		°C
$F_{MAXREAD}$	eNVM maximum read frequency	25	25	25	25	25	25	MHz

The following table lists the eNVM page programming in worst-case conditions when $V_{DD} = 1.14\text{ V}$, $V_{PPNVM} = V_{PP} = 2.375\text{ V}$.

Table 273 • eNVM Page Programming

Symbol	Description	Operating Temperature Range						Unit
		-1	-Std	-1	-Std	-1	-Std	
T_J	Junction temperature range	-55 °C to 125 °C		-40 °C to 100 °C		0 °C to 85 °C		°C
$T_{PAGEPGM}$	eNVM page programming time	40	40	40	40	40	40	ms

2.3.16 SRAM PUF

For more details on static random-access memory (SRAM) physical unclonable functions (PUF) services, see [AC434: Using SRAM PUF System Service in SmartFusion2 Application Note](#).

The following table lists the SRAM PUF in worst-case industrial conditions when $T_J = 100\text{ }^\circ\text{C}$, $V_{DD} = 1.14\text{ V}$.

Table 274 • SRAM PUF

Service	PUF Off		PUF On		Unit
	Typ	Max	Typ	Max	
Create activation code	709.1	746.4	754.4	762.5	ms
Delete activation code	1329.3	1399.3	1414.1	1429.3	ms
Create intrinsic keycode	656.6	691.1	698.5	706.0	ms
Create extrinsic keycode	656.6	691.1	698.5	706.0	ms
Get number of keys	1.3	1.4	1.4	1.4	ms
Export (Kc0, Kc1)	998.0	1050.5	1061.7	1073.1	ms
Export 2 keycodes	2020.2	2126.5	2149.2	2172.3	ms
Export 4 keycodes	3065.7	3227.0	3261.3	3296.4	ms
Export 8 keycodes	5101.0	5369.5	5426.6	5485.0	ms
Export 16 keycodes	9212.1	9697.0	9800.1	9905.5	ms
Import (Kc0, Kc1)	39.7	41.8	42.2	42.7	ms
Import 2 keycodes	50.1	52.7	53.3	53.9	ms
Import 4 keycodes	60.6	63.8	64.5	65.2	ms
Import 8 keycodes	80.9	85.1	86.1	87.0	ms
Import 16 keycodes	123.8	130.4	131.7	133.2	ms
Delete keycode	552.5	581.6	587.8	594.1	ms
Fetch key	31.4	33.0	33.4	33.7	ms
Fetch ecc key	20.0	21.1	21.3	21.5	ms
Get seed	2.0	2.1	2.2	2.2	ms

2.3.17 Non-Deterministic Random Bit Generator (NRBG) Characteristics

For more information about NRBG, see *AC407: Using NRBG Services in SmartFusion2 and IGLOO2 Devices Application Note*. The following table lists the NRBG in worst-case industrial conditions when $T_J = 100\text{ }^\circ\text{C}$, $V_{DD} = 1.14\text{ V}$.

Table 275 • Non-Deterministic Random Bit Generator (NRBG)

Service	Timing	Unit	Conditions	
			Prediction Resistance	Additional Input
Instantiate	85	ms	OFF	X
Generate (after Instantiate) ¹	4.5 ms + (6.25 us/byte x No. of Bytes)		OFF	0
	6.0 ms + (6.25 us/byte x No. of Bytes)		OFF	64
	7.0 ms + (6.25 us/byte x No. of Bytes)		OFF	128
Generate (after Instantiate)	47	ms	ON	X
Generate (subsequent) ¹	0.5 ms + (6.25 us/byte x No. of Bytes)		OFF	0
	2.0 ms + (6.25 us/byte x No. of Bytes)		OFF	64
	3.0 ms + (6.25 us/byte x No. of Bytes)		OFF	128
Generate (subsequent)	43	ms	ON	X
Reseed	40	ms		
Uninstantiate	0.16	ms		
Reset	0.10	ms		
Self test	20	ms	First time after power-up	
	6	ms	Subsequent	

1. If PUF_OFF, generate will incur additional PUF delay time for consecutive service calls.

2.3.18 Cryptographic Block Characteristics

For more information about cryptographic block and associated services, see *AC410: Using AES System Services in SmartFusion2 and IGLOO2 Devices Application Note* and *AC432: Using SHA-256 System Services in SmartFusion2 and IGLOO2 Devices Application Note*.

The following table lists the cryptographic block characteristics in worst-case industrial conditions when $T_J = 100\text{ }^\circ\text{C}$, $V_{DD} = 1.14\text{ V}$.

Table 276 • Cryptographic Block Characteristics

Service	Conditions	Timing	Unit
Any service	First certificate check penalty at boot	11.5	ms
AES128/256 (encoding-/decoding) ¹	100 blocks up to 64k blocks	700	kbps

Table 276 • Cryptographic Block Characteristics (continued)

Service	Conditions	Timing	Unit
SHA256	512 bits	540	kbps
	1024 bits	780	kbps
	2048 bits	950	kbps
	24 kbits	1140	kbps
HMAC	512 bytes	820	kbps
	1024 bytes	890	kbps
	2048 bytes	930	kbps
	24 kbytes	980	kbps
KeyTree		1.8	ms
Challenge-response	PUF = OFF	25	ms
	PUF = ON	7	ms
ECC point multiplication		590	ms
ECC point addition		8	ms

1. Using cypher block chaining (CBC) mode.

2.3.19 Crystal Oscillator

The following table describes the electrical characteristics of the crystal oscillator in the IGLOO2 FPGA and SmartFusion2 SoC FPGAs.

Table 277 • Electrical Characteristics of the Crystal Oscillator – High Gain Mode (20 MHz)

Parameter	Symbol	Min	Typ	Max	Unit	Condition
Operating frequency	FXTAL		20		MHz	
Accuracy	ACCXTAL			0.0047	%	005, 010, 025, 050, 060, and 090 devices
				0.0058	%	150 devices
Output duty cycle	CYCXTAL		49–51	47–53	%	
Output period jitter (peak to peak)	JITPERXTAL		200	300	ps	
Output cycle to cycle jitter (peak to peak)	JITCYCXTAL		200	300	ps	010, 025, 050, and 060 devices
			250	410	ps	150 devices
			250	550	ps	005 and 090 devices
Operating current	IDYNXTAL		1.5		mA	010, 050, and 060 devices
			1.65		mA	005, 025, 090, and 150 devices
Input logic level high	VIHXTAL	0.9 V _{PP}			V	
Input logic level low	VILXTAL			0.1 V _{PP}	V	

Table 277 • Electrical Characteristics of the Crystal Oscillator – High Gain Mode (20 MHz) (continued)

Parameter	Symbol	Min	Typ	Max	Unit	Condition
Startup time (with regard to stable oscillator output)	SUXTAL			0.8	ms	005, 010, 025, and 050 devices
				1.0	ms	090 and 150 devices

Table 278 • Electrical Characteristics of the Crystal Oscillator – Medium Gain Mode (2 MHz)

Parameter	Symbol	Min	Typ	Max	Unit	Condition
Operating frequency	FXTAL		2		MHz	
Accuracy	ACCXTAL			0.00105	%	050 devices
				0.003	%	005, 010, 025, 090, and 150 devices
				0.004	%	060 devices
Output duty cycle	CYCXTAL		49–51	47–53	%	
Output period jitter (peak to peak)	JITPERXTAL		1	5	ns	
Output cycle to cycle jitter (peak to peak)	JITCYCXTAL		1	5	ns	
Operating current	IDYNXTAL		0.3		mA	
Input logic level high	VIHXTAL	0.9 V _{PP}			V	
Input logic level low	VILXTAL			0.1 V _{PP}	V	
Startup time (with regard to stable oscillator output)	SUXTAL			4.5	ms	010 and 050 devices
				5	ms	005 and 025 devices
				7	ms	090 and 150 devices

Table 279 • Electrical Characteristics of the Crystal Oscillator – Low Gain Mode (32 kHz)

Parameter	Symbol	Min	Typ	Max	Unit	Condition
Operating frequency	FXTAL		32		kHz	
Accuracy	ACCXTAL			0.004	%	005, 010, 025, 050, 060, and 090 devices
				0.005	%	150 devices
Output duty cycle	CYCXTAL		49–51	47–53	%	
Output period jitter (peak to peak)	JITPERXTAL		150	300	ns	
Output cycle to cycle jitter (peak to peak)	JITCYCXTAL		150	300	ns	
Operating current	IDYNXTAL		0.044		mA	010 and 050 devices
			0.060		mA	005, 025, 060, 090, and 150 devices
Input logic level high	VIHXTAL	0.9 V _{PP}			V	
Input logic level low	VILXTAL			0.1 V _{PP}	V	
Startup time (with regard to stable oscillator output)	SUXTAL			115	ms	005, 025, 050, 090, and 150 devices
				126	ms	010 devices

2.3.20 On-Chip Oscillator

The following tables describe the electrical characteristics of the available on-chip oscillators in the IGLOO2 FPGAs and SmartFusion2 SoC FPGAs.

Table 280 • Electrical Characteristics of the 50 MHz RC Oscillator

Parameter	Symbol	Typ	Max	Unit	Condition
Operating frequency	F50RC	50		MHz	
Accuracy	ACC50RC	1	4	%	050 devices
		1	5	%	005, 025, and 060 devices
		1	6.3	%	090 devices
		1	7.1	%	010 and 150 devices
Output duty cycle	CYC50RC	49–51	46.5–53.5	%	
Output jitter (peak to peak)	JIT50RC	Period Jitter			
		200	300	ps	005, 010, 050, and 060 devices
		200	400	ps	150 devices
		300	500	ps	025 and 090 devices
		Cycle-to-Cycle Jitter			
		200	300	ps	005 and 050 devices
		320	420	ps	010, 060, and 150 devices
		320	850	ps	025 and 090 devices
Operating current	IDYN50RC	6.5		mA	

Table 281 • Electrical Characteristics of the 1 MHz RC Oscillator

Parameter	Symbol	Typ	Max	Unit	Condition
Operating frequency	F1RC	1		MHz	
Accuracy	ACC1RC	1	3	%	005, 010, 025, and 050 devices
		1	4.5	%	060, and 150 devices
		1	5.6	%	090 devices
Output duty cycle	CYC1RC	49–51	46.5–53.5	%	005, 010, 025, 050, 090 and 150 devices
		49-51	46.0-54.0	%	060 devices
Output jitter (peak to peak)	JIT1RC	Period Jitter			
		10	20	ns	005, 010, 025, and 050 devices
		10	28	ns	060, 090 and 150 devices
		Cycle-to-Cycle Jitter			
		10	20	ns	005, 010, and 050 devices
		10	35	ns	025, 060, and 150 devices
		10	45	ns	090 devices
Operating current	IDYN1RC	0.1		mA	
Startup time	SU1RC	17		μs	050, 090, and 150 devices
		18		μs	005, 010, and 025 devices

2.3.21 Clock Conditioning Circuits (CCC)

The following table lists the CCC/PLL specifications in worst-case industrial conditions when $T_J = 100\text{ }^\circ\text{C}$, $V_{DD} = 1.14\text{ V}$.

Table 282 • IGLOO2 and SmartFusion2 SoC FPGAs CCC/PLL Specification

Parameter	Min	Typ	Max	Unit	Conditions
Clock conditioning circuitry input frequency F_{IN_CCC}	1		200	MHz	All CCC
	0.032		200	MHz	32 kHz capable CCC
Clock conditioning circuitry output frequency $F_{OUT_CCC}^1$	0.078		400	MHz	
PLL VCO frequency ²	500		1000	MHz	
Delay increments in programmable delay blocks		75	100	ps	
Number of programmable values in each programmable delay block			64		
Acquisition time		70	100	μs	$F_{IN} \geq 1\text{ MHz}$
		1	16	ms	$F_{IN} = 32\text{ kHz}$
Input duty cycle (reference clock)					Internal Feedback
	10		90	%	$1\text{ MHz} \leq F_{IN_CCC} \leq 25\text{ MHz}$
	25		75	%	$25\text{ MHz} \leq F_{IN_CCC} \leq 100\text{ MHz}$
	35		65	%	$100\text{ MHz} \leq F_{IN_CCC} \leq 150\text{ MHz}$
	45		55	%	$150\text{ MHz} \leq F_{IN_CCC} \leq 200\text{ MHz}$
					External Feedback (CCC, FPGA, Off-chip)
	25		75	%	$1\text{ MHz} \leq F_{IN_CCC} \leq 25\text{ MHz}$
	35		65	%	$25\text{ MHz} \leq F_{IN_CCC} \leq 35\text{ MHz}$
	45		55	%	$35\text{ MHz} \leq F_{IN_CCC} \leq 50\text{ MHz}$
	Output duty cycle	48		52	%
48			52	%	005, 010, and 025 devices $F_{OUT} < 350\text{ MHz}$
46			54	%	005, 010, and 025 devices $350\text{ MHz} \leq F_{out} \leq 400\text{ MHz}$
48			52	%	060 and 090 devices $F_{OUT} \leq 100\text{ MHz}$
44			52	%	060 and 090 devices $100\text{ MHz} \leq F_{OUT} \leq 400\text{ MHz}$
48			52	%	150 devices $F_{OUT} \leq 120\text{ MHz}$
45			52	%	150 devices $120\text{ MHz} \leq F_{OUT} \leq 400\text{ MHz}$
Spread Spectrum Characteristics					
Modulation frequency range	25	35	50	k	
Modulation depth range	0		1.5	%	
Modulation depth control		0.5		%	

1. The minimum output clock frequency is limited by the PLL. For more information, see [UG0449: SmartFusion2 and IGLOO2 Clocking Resources User Guide](#).
2. The PLL is used in conjunction with the Clock Conditioning Circuitry. Performance is limited by the CCC output frequency.

The following table lists the CCC/PLL jitter specifications in worst-case industrial conditions when $T_J = 100\text{ }^\circ\text{C}$, $V_{DD} = 1.14\text{ V}$.

Table 283 • IGLOO2 and SmartFusion2 SoC FPGAs CCC/PLL Jitter Specifications

CCC Output Maximum Peak-to-Peak Period Jitter F_{OUT_CCC}						
Parameter	Conditions/Package Combinations				Unit	
10 FG484, 050 FG896/FG484/FCS325 Packages¹	SSO = 0	$0 < SSO \leq 2$	$SSO \leq 4$	$SSO \leq 8$	$SSO \leq 16$	
20 MHz to 100 MHz	$\text{Max}(110, \pm 1\% \times (1/F_{OUT_CCC}))$	$\text{Max}(150, \pm 1\% \times (1/F_{OUT_CCC}))$				ps
100 MHz to 400 MHz	$\text{Max}(120, \pm 1\% \times (1/F_{OUT_CCC}))$	$\text{Max}(150, \pm 1\% \times (1/F_{OUT_CCC}))$		$\text{Max}(170, \pm 1\% \times (1/F_{OUT_CCC}))$		ps
025 FG484/FCS325 Package¹	$0 < SSO \leq 16$					
20 MHz to 74 MHz	$\pm 1\% \times (1/F_{OUT_CCC})$					ps
74 MHz to 400 MHz	210					ps
005 FG484 Package¹	$0 < SSO \leq 16$					
20 MHz to 53 MHz	$\pm 1\% \times (1/F_{OUT_CCC})$					ps
53 MHz to 400 MHz	270					ps
090 FG676 and FC325 Package¹	$0 < SSO \leq 16$					
20 MHz to 100 MHz	$\pm 1\% \times (1/F_{OUT_CCC})$					ps
100 MHz to 400 MHz	150					ps
060 FG676 Package¹	$0 < SSO \leq 16$					
20 MHz to 100 MHz	$\pm 1\% \times (1/F_{OUT_CCC})$					ps
100 MHz to 400 MHz	150					ps
150 FC1152 Package¹	$0 < SSO \leq 16$					
20 MHz to 100 MHz	$\pm 1\% \times (1/F_{OUT_CCC})$					ps
100 MHz to 400 MHz	120					ps

1. SSO data is based on LVCMOS 2.5 V MSIO and/or MSIOD bank I/Os.

2.3.22 JTAG

Table 284 • JTAG 1532 for 005, 010, 025, and 050 Devices

Parameter	Symbol	005		010		025		050		Unit
		-1	-Std	-1	-Std	-1	-Std	-1	-Std	
Clock to Q (data out)	T_{TCK2Q}	7.47	8.79	7.73	9.09	7.75	9.12	7.89	9.28	ns
Reset to Q (data out)	T_{RSTB2Q}	7.65	9	6.43	7.56	6.13	7.21	7.40	8.70	ns
Test data input setup time	T_{DISU}	-1.05	-0.89	-0.69	-0.59	-0.67	-0.57	-0.30	-0.25	ns
Test data input hold time	T_{DIHD}	2.38	2.8	2.38	2.8	2.42	2.85	2.09	2.45	ns
Test mode select setup time	T_{TMSSU}	-0.73	-0.62	-1.03	-1.21	-1.1	-0.94	0.28	0.33	ns
Test mode select hold time	T_{TMDHD}	1.36	1.6	1.43	1.68	1.93	2.27	0.16	0.19	ns
ResetB removal time	$T_{TRSTREM}$	-0.77	-0.65	-1.08	-0.92	-1.33	-1.13	-0.45	-0.38	ns
ResetB recovery time	$T_{TRSTREC}$	-0.76	-0.65	-1.07	-0.91	-1.34	-1.14	-0.45	-0.38	ns
TCK maximum frequency	F_{TCKMAX}	25	21.25	25	21.25	25	21.25	25.00	21.25	MHz

Table 285 • JTAG 1532 for 060, 090, and 150 Devices

Parameter	Symbol	060		090		150		Unit
		-1	-Std	-1	-Std	-1	-Std	
Clock to Q (data out)	T_{TCK2Q}	8.38	9.86	8.96	10.54	8.66	10.19	ns
Reset to Q (data out)	T_{RSTB2Q}	8.54	10.04	7.75	9.12	8.79	10.34	ns
Test data input setup time	T_{DISU}	-1.18	-1	-1.31	-1.11	-0.96	-0.82	ns
Test data input hold time	T_{DIHD}	2.52	2.97	2.68	3.15	2.57	3.02	ns
Test mode select setup time	T_{TMSSU}	-0.97	-0.83	-1.02	-0.87	-0.53	-0.45	ns
Test mode select hold time	T_{TMDHD}	1.7	2	1.67	1.96	1.02	1.2	ns
ResetB removal time	$T_{TRSTREM}$	-1.21	-1.03	-0.76	-0.65	-1.03	-0.88	ns
ResetB recovery time	$T_{TRSTREC}$	-1.21	-1.03	-0.77	-0.65	-1.03	-0.88	ns
TCK maximum frequency	F_{TCKMAX}	25	21.25	25	21.25	25	21.25	MHz

2.3.23 System Controller SPI Characteristics

The following table lists the system controller characteristics in worst-case industrial conditions when $T_J = 100\text{ }^\circ\text{C}$, $V_{DD} = 1.14\text{ V}$.

Table 286 • System Controller SPI Characteristics for All Devices

Symbol	Description	Conditions	Min	Typ	Unit
sp1	SC_SPI_SCK minimum period		20		ns
sp2	SC_SPI_SCK minimum pulse width high		10		ns
sp3	SC_SPI_SCK minimum pulse width low		10		ns
sp4 ¹	SC_SPI_SCK, SC_SPI_SDO, SC_SPI_SS rise time (10%–90%) 1	I/O configuration: LVTTTL 3.3 V– 20 mA AC loading: 35 pF Test conditions: Typical voltage, 25 °C		1.239	ns
sp5 ¹	SC_SPI_SCK, SC_SPI_SDO, SC_SPI_SS fall time (10%–90%) 1	I/O configuration: LVTTTL 3.3 V– 20 mA AC loading: 35 pF Test conditions: Typical voltage, 25 °C		1.245	ns
sp6	Data from master (SC_SPI_SDO) setup time		160		ns
sp7	Data from master (SC_SPI_SDO) hold time		160		ns
sp8	SC_SPI_SDI setup time		20		ns
sp9	SC_SPI_SDI hold time		20		ns

- For specific Rise/Fall Times, board design considerations and detailed output buffer resistances, use the corresponding IBIS models located on the Microsemi SoC Products Group website: <http://www.microsemi.com/soc/download/ibis/default.aspx>. Use the supported I/O Configurations for the System Controller SPI in the following table.

Table 287 • Supported I/O Configurations for System Controller SPI (for MSIO Bank Only)

Voltage Supply	I/O Drive Configuration	Unit
3.3 V	20	mA
2.5 V	16	mA
1.8 V	12	mA
1.5 V	8	mA
1.2 V	4	mA

2.3.24 Power-up to Functional Times

The following table lists the SmartFusion2 power-up to functional times in worst-case industrial conditions when $T_J = 100\text{ }^\circ\text{C}$, $V_{DD} = 1.14\text{ V}$.

Table 288 • Power-up to Functional Times for SmartFusion2

Symbol	From	To	Description	Maximum Power-up to Functional Time for SmartFusion2 (uS)						
				005	010	025	050	060	090	150
$T_{POR2OUT}$	POWER_ON_RESET_N	Output available at I/O	Fabric to output	647	500	531	483	474	524	647
$T_{POR2MSSRST}$	POWER_ON_RESET_N	MSS_RESE T_N_M2F	Fabric to MSS	644	497	528	480	468	518	641
$T_{MSSRST2OUT}$	MSS_RESET_N_M2F	Output available at I/O	MSS to output	3.6	3.6	3.6	3.4	4.9	4.8	4.8
$T_{VDD2OUT}$	V_{DD}	Output available at I/O	V_{DD} at its minimum threshold level to output	3096	2975	3012	2959	2869	2992	3225
$T_{VDD2POR}$	V_{DD}	POWER_ON_RESET_N	V_{DD} at its minimum threshold level to fabric	2476	2487	2496	2486	2406	2563	2602
$T_{VDD2MSSRST}$	V_{DD}	MSS_RESE T_N_M2F	V_{DD} at its minimum threshold level to MSS	3093	2972	3008	2956	2864	2987	3220
$T_{VDD2WPU}$	DEVRST_N	DDRIO Inbuf weak pull	DEVRST_N to Inbuf weak pull	2500	2487	2509	2475	2507	2519	2617
	DEVRST_N	MSIO Inbuf weak pull	DEVRST_N to Inbuf weak pull	2504	2491	2510	2478	2517	2525	2620
	DEVRST_N	MSIOD Inbuf weak pull	DEVRST_N to Inbuf weak pull	2479	2468	2493	2458	2486	2499	2595

Note: For more information about power-up times, see [UG0331: SmartFusion2 Microcontroller Subsystem User Guide](#).

Figure 17 • Power-up to Functional Timing Diagram for SmartFusion2

The following table lists the IGLOO2 power-up to functional times in worst-case industrial conditions when $T_J = 100\text{ }^\circ\text{C}$, $V_{DD} = 1.14\text{ V}$.

Table 289 • Power-up to Functional Times for IGLOO2

Symbol	From	To	Description	Maximum Power-up to Functional Time for IGLOO2 (uS)						
				005	010	025	050	060	090	150
$T_{POR2OUT}$	POWER_ON_RESET_N	Output available at I/O	Fabric to output	114	114	114	113	114	114	114
$T_{VDD2OUT}$	V_{DD}	Output available at I/O	V_{DD} at its minimum threshold level to output	2587	2600	2607	2558	2591	2600	2699
$T_{VDD2POR}$	V_{DD}	POWER_ON_RESET_N	V_{DD} at its minimum threshold level to fabric	2474	2486	2493	2445	2477	2486	2585
$T_{VDD2WPU}$	DEVRST_N	DDRIO Inbuf weak pull	DEVRST_N to Inbuf weak pull	2500	2487	2509	2475	2507	2519	2617
	DEVRST_N	MSIO Inbuf weak pull	DEVRST_N to Inbuf weak pull	2504	2491	2510	2478	2517	2525	2620
	DEVRST_N	MSIOD Inbuf weak pull	DEVRST_N to Inbuf weak pull	2479	2468	2493	2458	2486	2499	2595

Note: For more information about power-up times, see [UG0448: IGLOO2 FPGA High Performance Memory Subsystem User Guide](#).

Figure 18 • Power-up to Functional Timing Diagram for IGLOO2

2.3.25 DEVRST_N Characteristics

Table 290 • DEVRST_N Characteristics for All Devices

Parameter	Symbol	Max	Unit
DEVRST_N ramp rate	$T_{RAMPDEVRSTN}$	1	us
DEVRST_N cycling rate	$F_{MAXPDEVRSTN}$	100	kHz

2.3.26 DEVRST_N to Functional Times

The following table lists the SmartFusion2 DEVRST_N to functional times in worst-case industrial conditions when $T_J = 100\text{ }^{\circ}\text{C}$, $V_{DD} = 1.14\text{ V}$.

Table 291 • DEVRST_N to Functional Times for SmartFusion2

Symbol	From	To	Description	Maximum Power-up to Functional Time for SmartFusion2 (uS)						
				005	010	025	050	060	090	150
$T_{POR2OUT}$	POWER_ON_RESET_N	Output available at I/O	Fabric to output	518	501	527	521	422	419	694
$T_{POR2MSSRST}$	POWER_ON_RESET_N	MSS_RESET_N_M2F	Fabric to MSS	515	497	524	518	417	414	689
$T_{MSSRST2OUT}$	MSS_RESET_N_M2F	Output available at I/O	MSS to output	3.5	3.5	3.5	3.3	4.8	4.8	4.8
$T_{DEVRST2OUT}$	DEVRST_N	Output available at I/O	V_{DD} at its minimum threshold level to output	706	768	715	691	641	635	871

Table 291 • DEVRST_N to Functional Times for SmartFusion2 (continued)

Symbol	From	To	Description	Maximum Power-up to Functional Time for SmartFusion2 (uS)						
				005	010	025	050	060	090	150
$T_{DEVRST2POR}$	DEVRST_N	POWER_ON_RESET_N	V_{DD} at its minimum threshold level to fabric	233	289	216	213	237	234	219
$T_{DEVRST2MSSRST}$	DEVRST_N	MSS_RESET_N_M2F	V_{DD} at its minimum threshold level to MSS	702	765	712	688	636	630	866
$T_{DEVRST2WPU}$	DEVRST_N	DDRIO Inbuf weak pull	DEVRST_N to Inbuf weak pull	208	202	197	193	216	215	215
	DEVRST_N	MSIO Inbuf weak pull	DEVRST_N to Inbuf weak pull	208	202	197	193	216	215	215
	DEVRST_N	MSIOD Inbuf weak pull	DEVRST_N to Inbuf weak pull	208	202	197	193	216	215	215

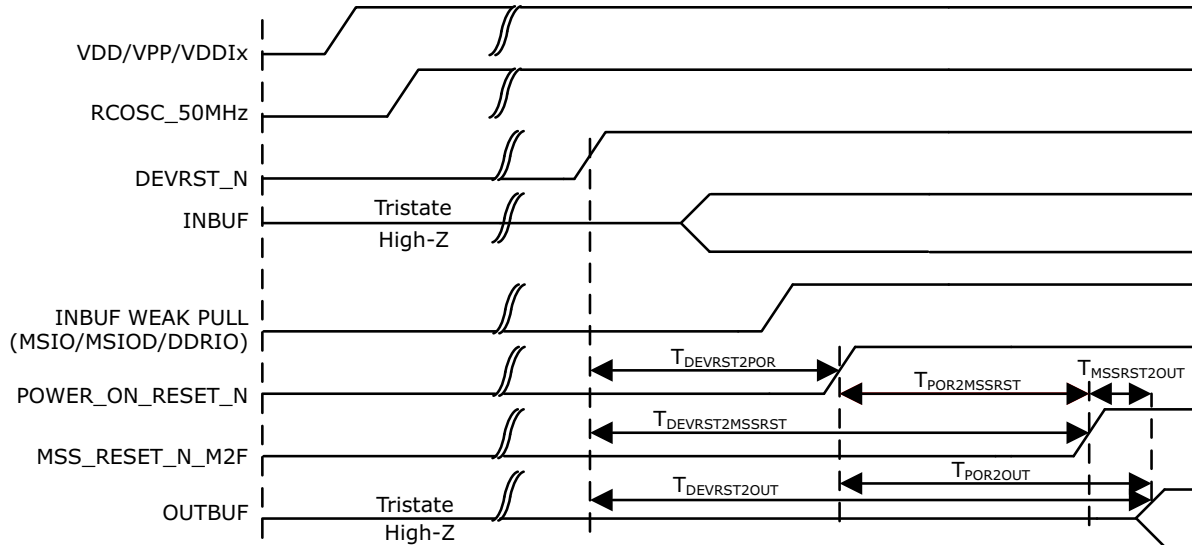
Figure 19 • DEVRST_N to Functional Timing Diagram for SmartFusion2

The following table lists the IGLOO2 DEVRST_N to functional times in worst-case industrial conditions when $T_J = 100\text{ }^\circ\text{C}$, $V_{DD} = 1.14\text{ V}$.

Table 292 • DEVRST_N to Functional Times for IGLOO2

Symbol	From	To	Description	Maximum Power-up to Functional Time for IGLOO2 (uS)						
				005	010	025	050	060	090	150
$T_{POR2OUT}$	POWER_ON_RESET_N	Output available at I/O	Fabric to output	114	116	113	113	115	115	114
$T_{DEVRST2OUT}$	DEVRST_N	Output available at I/O	V_{DD} at its minimum threshold level to output	314	353	314	307	343	341	341
$T_{DEVRST2POR}$	DEVRST_N	POWER_ON_RESET_N	V_{DD} at its minimum threshold level to fabric	200	238	201	195	230	229	227
$T_{DEVRST2WPU}$	DEVRST_N	DDRIO Inbuf weak pull	DEVRST_N to Inbuf weak pull	208	202	197	193	216	215	215
	DEVRST_N	MSIO Inbuf weak pull	DEVRST_N to Inbuf weak pull	208	202	197	193	216	215	215
	DEVRST_N	MSIOD Inbuf weak pull	DEVRST_N to Inbuf weak pull	208	202	197	193	216	215	215

Figure 20 • DEVRST_N to Functional Timing Diagram for IGLOO2



2.3.27 Flash*Freeze Timing Characteristics

The following table lists the Flash*Freeze entry and exit times in worst-case industrial conditions when $T_J = 100\text{ }^\circ\text{C}$, $V_{DD} = 1.14\text{ V}$.

Table 293 • Flash*Freeze Entry and Exit Times

Parameter	Symbol	Entry/Exit Timing			Unit	Conditions
		FCLK = 100MHz		FCLK = 3 MHz		
		005, 010, 025, 060, 090, and 150	050	All Devices		
Entry time	TFF_ENTRY	160	150	320	μs	eNVM and MSS/HPMS PLL = ON
		215	200	430	μs	eNVM and MSS/HPMS PLL= OFF
Exit time with respect to the MSS PLL Lock	TFF_EXIT	100	100	140	μs	eNVM and MSS/HPMS PLL = ON during F*F
		136	120	190	μs	eNVM = ON and MSS/HPMS PLL = OFF during F*F and MSS/HPMS PLL turned back on at exit
		200	200	285	μs	eNVM and MSS/HPMS PLL = OFF during F*F and both are turned back on at exit
		200	200	285	μs	eNVM = OFF and MSS/HPMS PLL = ON during F*F and eNVM turned back on at exit

Table 293 • Flash*Freeze Entry and Exit Times (continued)

Parameter	Symbol	Entry/Exit Timing FCLK = 100MHz			Entry/Exit Timing FCLK = 3 MHz	
		005, 010, 025, 060, 090, and 150	050	All Devices	Unit	Conditions
Exit time with respect to the fabric PLL lock ¹	TFF_EXIT	1.5	1.5	1.5	ms	eNVM and MSS/HPMS PLL = ON during F*F
		1.5	1.5	1.5	ms	eNVM and MSS/HPMS PLL = OFF during F*F and both are turned back on at exit
Exit time with respect to the fabric buffer output	TFF_EXIT	21	15	21	μs	eNVM and MSS/HPMS PLL = ON during F*F
		65	55	65	μs	eNVM and MSS/HPMS PLL = OFF during F*F and both are turned back on at exit

1. PLL Lock Delay set to 1024 cycles (default).

2.3.28 DDR Memory Interface Characteristics

The following table lists the DDR memory interface characteristics in worst-case industrial conditions when $T_J = 100\text{ }^{\circ}\text{C}$, $V_{DD} = 1.14\text{ V}$.

Table 294 • DDR Memory Interface Characteristics

Standard	Supported Data Rate		Unit
	Min	Max	
DDR3	667	667	Mbps
DDR2	667	667	Mbps
LPDDR	50	400	Mbps

2.3.29 SFP Transceiver Characteristics

IGLOO2 and SmartFusion2 SerDes complies with small form-factor pluggable (SFP) requirements as specified in SFP INF-80741. The following table provides the electrical characteristics.

The following table lists the SFP transceiver electrical characteristics in worst-case industrial conditions when $T_J = 100\text{ }^{\circ}\text{C}$, $V_{DD} = 1.14\text{ V}$.

Table 295 • SFP Transceiver Electrical Characteristics

Pin	Direction	Differential Peak-Peak Voltage		Unit
		Min	Max	
RD+/- ¹	Output	1600	2400	mV
TD+/- ²	Input	350	2400	mV

1. Based on default SerDes transmitter settings for PCIe Gen1. Lower amplitudes are available through programming changes to TX_AMP setting.
2. Based on Input Voltage Common-Mode (VICM) = 0 V. Requires AC Coupling.

2.3.30 SerDes Electrical and Timing AC and DC Characteristics

PCIe is a high-speed, packet-based, point-to-point, low-pin-count, serial interconnect bus. The IGLOO2 and SmartFusion2 SoC FPGAs has up to four hard high-speed serial interface blocks. Each SerDes block contains a PCIe system block. The PCIe system is connected to the SerDes block.

The following table lists the transmitter parameters in worst-case industrial conditions when $T_J = 100\text{ }^\circ\text{C}$, $V_{DD} = 1.14\text{ V}$.

Table 296 • Transmitter Parameters

Symbol	Description	Min	Max	Unit
VTX-DIFF-PP	Differential swing (2.5 Gbps, 5.0 Gbps)	0.8	1.2	V
VTX-CM-AC-P	Output common mode voltage (2.5 Gbps)		20	mV
VTX-CM-AC-PP	Output common mode voltage (5.0 Gbps)		100	mV
VTX-RISE-FALL	Rise and fall time (20% to 80%, 2.5 Gbps)	0.125		UI
	Rise and fall time (20% to 80%, 5.0 Gbps)	0.15		UI
ZTX-DIFF-DC	Output impedance–differential	80	120	Ω
LTX-SKEW	Lane-to-lane TX skew within a SerDes block (2.5 Gbps)		500 ps + 2 UI	ps
	Lane-to-lane TX skew within a SerDes block (5.0 Gbps)		500 ps + 4 UI	ps
RLTX-DIFF	Return loss differential mode (2.5 Gbps)	–10		dB
	Return loss differential mode (5.0 Gbps) 0.05 GHz to 1.25 GHz	–10		dB
	1.25 GHz to 2.5 GHz	–8		dB
RLTX-CM	Return loss common mode (2.5 Gbps, 5.0 Gbps)	–6		dB
TX-LOCK-RST	Transmit PLL lock time from reset		10	μs
VTX-AMP	100 mV setting	90	150	mV
	400 mV setting	320	480	mV
	800 mV setting	660	940	mV
	1200 mV setting	950	1400	mV

The following table lists the receiver pa in worst-case industrial conditions when $T_J = 100\text{ }^\circ\text{C}$, $V_{DD} = 1.14\text{ V}$.

Table 297 • Receiver Parameters

Symbol	Description	Min	Typ	Max	Unit
VRX-IN-PP-CC	Differential input peak-to-peak sensitivity (2.5 Gbps)	0.238		1.2	V
	Differential input peak-to-peak sensitivity (2.5 Gbps, de-emphasized)	0.219		1.2	V
	Differential input peak-to-peak sensitivity (5.0 Gbps)	0.300		1.2	V
	Differential input peak-to-peak sensitivity (5.0 Gbps, de-emphasized)	0.300		1.2	V
VRX-CM-AC-P	Input common mode range (AC coupled)			150	mV
ZRX-DIFF-DC	Differential input termination	80	100	120	Ω
REXT	External calibration resistor	1,188	1,200	1,212	Ω
CDR-LOCK-RST	CDR relock time from reset			15	μs
RLRX-DIFF	Return loss differential mode (2.5 Gbps)	-10			dB
	Return loss differential mode (5.0 Gbps)				
	0.05 GHz to 1.25 GHz	-10			dB
	1.25 GHz to 2.5 GHz	-8			dB
RLRX-CM	Return loss common mode (2.5 Gbps, 5.0 Gbps)	-6			dB
RX-CID ¹	CID limit PCIe Gen1/2			200	UI
VRX-IDLE-DET-DIFF-PP	Signal detect limit	65		175	mV

1. AC-coupled, BER = e^{-12} , using synchronous clock.

Table 298 • SerDes Protocol Compliance

Protocol	Maximum Data Rate (Gbps)	-1	-Std
PCIe Gen 1	2.5	Yes	Yes
PCIe Gen 2	5.0	Yes	
XAUI	3.125	Yes	
Generic EPCS	3.2	Yes	
Generic EPCS	2.5	Yes	Yes

The following table lists the SerDes reference clock AC specifications in worst-case industrial conditions when $T_J = 100\text{ }^\circ\text{C}$, $V_{DD} = 1.14\text{ V}$.

Table 299 • SerDes Reference Clock AC Specifications

Parameter	Symbol	Min	Max	Unit
Reference clock frequency	F_{REFCLK}	100	160	MHz
Reference clock rise time	T_{RISE}	0.6	4	V/ns
Reference clock fall time	T_{FALL}	0.6	4	V/ns
Reference clock duty cycle	T_{CYC}	40	60	%
Reference clock mismatch	$M_{MREFCLK}$	-300	300	ppm
Reference spread spectrum clock	SSC_{ref}	0	5000	ppm

Table 300 • HCSL Minimum and Maximum DC Input Levels (Applicable to SerDes REFCLK Only)

Parameter	Symbol	Min	Typ	Max	Unit
Recommended DC Operating Conditions					
Supply voltage	V_{DDI}	2.375	2.5	2.625	V
HCSL DC Input Voltage Specification					
DC Input voltage	V_I	0		2.625	V
HCSL Differential Voltage Specification					
Input common mode voltage	V_{ICM}	0.05		2.4	V
Input differential voltage	V_{IDIFF}	100		1100	mV

Table 301 • HCSL Minimum and Maximum AC Switching Speeds (Applicable to SerDes REFCLK Only)

Parameter	Symbol	Min	Typ	Max	Unit
HCSL AC Specifications					
Maximum data rate (for MSIO I/O bank)	F_{MAX}			350	Mbps
HCSL Impedance Specifications					
Termination resistance	R_t		100		Ω

2.3.31 SmartFusion2 Specifications

2.3.31.1 MSS Clock Frequency

The following table lists the maximum frequency for MSS main clock in worst-case industrial conditions when $T_J = 100\text{ }^\circ\text{C}$, $V_{DD} = 1.14\text{ V}$.

Table 302 • Maximum Frequency for MSS Main Clock

Symbol	Description	-1	-Std	Unit
M3_CLK	Maximum frequency for the MSS main clock	166	142	MHz

2.3.31.2 SmartFusion2 Inter-Integrated Circuit (I²C) Characteristics

This section describes the DC and switching of the I²C interface. Unless otherwise noted, all output characteristics given are for a 100 pF load on the pins. For timing parameter definitions, see [Figure 21](#), page 125.

The following table lists the I²C characteristics in worst-case industrial conditions when $T_J = 100\text{ }^\circ\text{C}$, $V_{DD} = 1.14\text{ V}$

Table 303 • I²C Characteristics

Parameter	Symbol	Min	Typ	Max	Unit	Conditions
Input low voltage	V_{IL}	-0.3		0.8	V	See Single-Ended I/O Standards , page 24 for more information. I/O standard used for illustration: MSIO bank-LVTTL 8 mA low drive.
Input high voltage	V_{IH}	2		3.45	V	See Single-Ended I/O Standards , page 24 for more information. I/O standard used for illustration: MSIO bank-LVTTL 8 mA low drive.
Hysteresis of schmitt triggered inputs for $V_{DDI} > 2\text{ V}$	V_{HYS}	$0.05 \times V_{DDI}$			V	See Table 28 , page 23 for more information.
Input current high	I_{IL}			10	μA	See Single-Ended I/O Standards , page 24 for more information.
Input current low	I_{IH}			10	μA	See Single-Ended I/O Standards , page 24 for more information.
Input rise time	T_{ir}			1000	ns	Standard mode
				300	ns	Fast mode
Input fall time	T_{if}			300	ns	Standard mode
				300	ns	Fast mode
Maximum output voltage low (open drain) at 3 mA sink current for $V_{DDI} > 2\text{ V}$	V_{OL}			0.4	V	See Single-Ended I/O Standards , page 24 for more information. I/O standard used for illustration: MSIO bank-LVTTL 8 mA low drive.
Pin capacitance	C_{in}			10	pF	$V_{IN} = 0$, $f = 1.0\text{ MHz}$
Output fall time from V_{IHMin} to V_{ILMax}^1	t_{OF}^1		21.04		ns	V_{IHmin} to V_{ILMax} , CLOAD = 400 pF
			5.556		ns	V_{IHmin} to V_{ILMax} , CLOAD = 100 pF
Output rise time from V_{ILMax} to V_{IHMin}^1	t_{OR}^1		19.887		ns	V_{ILMax} to V_{IHmin} , CLOAD = 400 pF
			5.218		ns	V_{ILMax} to V_{IHmin} , CLOAD = 100 pF
Output buffer maximum pull-down resistance ^{2, 3}	$R_{pull-up}^{2,3}$			50	Ω	
Output buffer maximum pull-up resistance ^{2, 4}	$R_{pull-down}^{2,4}$			131.25	Ω	

Table 303 • I²C Characteristics (continued)

Parameter	Symbol	Min	Typ	Max	Unit	Conditions
Maximum data rate	D_{MAX}			400	Kbps	Fast mode
				100	Kbps	Standard mode
Pulse width of spikes which must be suppressed by the input filter	T_{FILT}		50		ns	Fast mode

1. These values are provided for MSIO Bank–LVTTTL 8 mA Low Drive at 25 °C, typical conditions. For board design considerations and detailed output buffer resistances, use the corresponding IBIS models located on the SoC Products Group website: <http://www.microsemi.com/soc/download/ibis/default.aspx>.
2. These maximum values are provided for information only. Minimum output buffer resistance values depend on V_{DDIX} , drive strength selection, temperature, and process. For board design considerations and detailed output buffer resistances, use the corresponding IBIS models located on the SoC Products Group website: <http://www.microsemi.com/soc/download/ibis/default.aspx>.
3. $R(PULL-DOWN-MAX) = (VOLspec)/IOLspec$.
4. $R(PULL-UP-MAX) = (VDDImax-VOHspec)/IOHspec$.

The following table lists the I²C switching characteristics in worst-case industrial conditions when $T_J = 100\text{ °C}$, $V_{DD} = 1.14\text{ V}$

Table 304 • I²C Switching Characteristics

Parameter	Symbol	-1		Unit
		Min	Min	
Low period of I2C_x_SCL	T_{LOW}	1	1	PCLK cycles
High period of I2C_x_SCL	T_{HIGH}	1	1	PCLK cycles
START hold time	$T_{HD;STA}$	1	1	PCLK cycles
START setup time	$T_{SU;STA}$	1	1	PCLK cycles
DATA hold time	$T_{HD;DAT}$	1	1	PCLK cycles
DATA setup time	$T_{SU;DAT}$	1	1	PCLK cycles
STOP setup time	$T_{SU;STO}$	1	1	PCLK cycles

Figure 21 • I²C Timing Parameter Definition

2.3.31.3 Serial Peripheral Interface (SPI) Characteristics

This section describes the DC and switching of the SPI interface. Unless otherwise noted, all output characteristics given are for a 35 pF load on the pins and all sequential timing characteristics are related to SPI_x_CLK. For timing parameter definitions, see [Figure 22](#), page 128.

The following table lists the SPI characteristics in worst-case industrial conditions when $T_J = 100\text{ }^\circ\text{C}$, $V_{DD} = 1.14\text{ V}$

Table 305 • SPI Characteristics for All Devices

Symbol	Description	Min	Typ	Max	Unit	Conditions
SPIFMAX	Maximum operating frequency of SPI interface			20	MHz	
sp1	SPI_[0 1]_CLK minimum period					
	SPI_[0 1]_CLK = PCLK/2	12			ns	
	SPI_[0 1]_CLK = PCLK/4	24.1			ns	
	SPI_[0 1]_CLK = PCLK/8	48.2			ns	
	SPI_[0 1]_CLK = PCLK/16	0.1			μs	
	SPI_[0 1]_CLK = PCLK/32	0.19			μs	
	SPI_[0 1]_CLK = PCLK/64	0.39			μs	
	SPI_[0 1]_CLK = PCLK/128	0.77			μs	
sp2	SPI_[0 1]_CLK minimum pulse width high					
	SPI_[0 1]_CLK = PCLK/2	6			ns	
	SPI_[0 1]_CLK = PCLK/4	12.05			ns	
	SPI_[0 1]_CLK = PCLK/8	24.1			ns	
	SPI_[0 1]_CLK = PCLK/16	0.05			μs	
	SPI_[0 1]_CLK = PCLK/32	0.095			μs	
	SPI_[0 1]_CLK = PCLK/64	0.195			μs	
	SPI_[0 1]_CLK = PCLK/128	0.385			μs	
sp3	SPI_[0 1]_CLK minimum pulse width low					
	SPI_[0 1]_CLK = PCLK/2	6			ns	
	SPI_[0 1]_CLK = PCLK/4	12.05			ns	
	SPI_[0 1]_CLK = PCLK/8	24.1			ns	
	SPI_[0 1]_CLK = PCLK/16	0.05			μs	
	SPI_[0 1]_CLK = PCLK/32	0.095			μs	
	SPI_[0 1]_CLK = PCLK/64	0.195			μs	
	SPI_[0 1]_CLK = PCLK/128	0.385			μs	
sp4	SPI_[0 1]_CLK, SPI_[0 1]_DO, SPI_[0 1]_SS rise time (10%–90%) ¹		2.77		ns	I/O Configuration: LVCMOS 2.5 V– 8 mA AC loading: 35 pF Test conditions: Typical voltage, 25 °C

Table 305 • SPI Characteristics for All Devices (continued)

Symbol	Description	Min	Typ	Max	Unit	Conditions
sp5	SPI_[0 1]_CLK, SPI_[0 1]_DO, SPI_[0 1]_SS fall time (10%–90%) ¹		2.906		ns	IO Configuration: LVCMOS 2.5 V-8 mA AC Loading: 35 pF Test Conditions: Typical Voltage, 25 °C
SPI master configuration (applicable for 005, 010, 025, and 050 devices)						
sp6m	SPI_[0 1]_DO setup time ²	(SPI_x_CLK_period/2) – 8.0			ns	
sp7m	SPI_[0 1]_DO hold time ²	(SPI_x_CLK_period/2) – 2.5			ns	
sp8m	SPI_[0 1]_DI setup time ²	12			ns	
sp9m	SPI_[0 1]_DI hold time ²	2.5			ns	
SPI slave configuration (applicable for 005, 010, 025, and 050 devices)						
sp6s	SPI_[0 1]_DO setup time ²	(SPI_x_CLK_period/2) – 17.0			ns	
sp7s	SPI_[0 1]_DO hold time ²	(SPI_x_CLK_period/2) + 3.0			ns	
sp8s	SPI_[0 1]_DI setup time ²	2			ns	
sp9s	SPI_[0 1]_DI hold time ²	7			ns	
SPI master configuration (applicable for 060, 090, and 150 devices)						
sp6m	SPI_[0 1]_DO setup time ²	(SPI_x_CLK_period/2) – 7.0			ns	
sp7m	SPI_[0 1]_DO hold time ²	(SPI_x_CLK_period/2) – 9.5			ns	
sp8m	SPI_[0 1]_DI setup time ²	15			ns	
sp9m	SPI_[0 1]_DI hold time ²	–2.5			ns	
SPI slave configuration (applicable for 060, 090, and 150 devices)						
sp6s	SPI_[0 1]_DO setup time ²	(SPI_x_CLK_period/2) – 16.0			ns	
sp7s	SPI_[0 1]_DO hold time ²	(SPI_x_CLK_period/2) – 3.5			ns	
sp8s	SPI_[0 1]_DI setup time ²	3			ns	
sp9s	SPI_[0 1]_DI hold time ²	2.5			ns	

1. For specific Rise/Fall Times board design considerations and detailed output buffer resistances, use the corresponding IBIS models located on the Microsemi SoC Products Group website: <http://www.microsemi.com/soc/download/ibis/default.aspx>.
2. For allowable pclk configurations, see Serial Peripheral Interface Controller section in the *UG0331: SmartFusion2 Microcontroller Subsystem User Guide*.

Figure 22 • SPI Timing for a Single Frame Transfer in Motorola Mode (SPH = 1)

2.3.32 CAN Controller Characteristics

The following table lists the CAN controller characteristics in worst-case industrial conditions when $T_J = 100\text{ }^\circ\text{C}$, $V_{DD} = 1.14\text{ V}$.

Table 306 • CAN Controller Characteristics

Parameter	Description	-1	-Std	Unit
FCANREFCLK ¹	Internally sourced CAN reference clock frequency	160	136	MHz
BAUDCANMAX	Maximum CAN performance baud rate	1	1	Mbps
BAUDCANMIN	Minimum CAN performance baud rate	0.05	0.05	Mbps

1. PCLK to CAN controller must be a multiple of 8 MHz.

2.3.33 USB Characteristics

The following table lists the USB characteristics in worst-case industrial conditions when $T_J = 100\text{ }^\circ\text{C}$, $V_{DD} = 1.14\text{ V}$.

Table 307 • USB Characteristics

Parameter	Description	-1	-Std	Unit
FUSBREFCLK	Internally sourced USB reference clock frequency	166	142	MHz
TUSBCLK	USB clock period	16.66	16.66	ns
TUSBPD	Clock to USB data propagation delay	9.0	9.0	ns
TUSBSU	Setup time for USB data	6.0	6.0	ns
TUSBHD	Hold time for USB data	0	0	ns

2.3.34 MMUART Characteristics

The following table lists the MMUART characteristics in worst-case industrial conditions when $T_J = 100\text{ }^\circ\text{C}$, $V_{DD} = 1.14\text{ V}$.

Table 308 • MMUART Characteristics

Parameter	Description	-1	-Std	Unit
FMMUART_REF_CLK	Internally sourced MMUART reference clock frequency.	166	142	MHz
BAUDMMUARTTx	Maximum transmit baud rate	10.375	8.875	Mbps
BAUDMMUARTRx	Maximum receive baud rate	10.375	8.875	Mbps

2.3.35 IGLOO2 Specifications

2.3.35.1 HPMS Clock Frequency

The following table lists the maximum frequency for HPMS main clock in worst-case industrial conditions when $T_J = 100\text{ }^\circ\text{C}$, $V_{DD} = 1.14\text{ V}$.

Table 309 • Maximum Frequency for HPMS Main Clock

Symbol	Description	-1	-Std	Unit
HPMS_CLK	Maximum frequency for the HPMS main clock	166	142	MHz

2.3.35.2 IGLOO2 Serial Peripheral Interface (SPI) Characteristics

This section describes the DC and switching of the SPI interface. Unless otherwise noted, all output characteristics given are for a 35 pF load on the pins and all sequential timing characteristics are related to SPI_0_CLK. For timing parameter definitions, see [Figure 23](#), page 131.

The following table lists the SPI characteristics in worst-case industrial conditions when $T_J = 100\text{ }^\circ\text{C}$, $V_{DD} = 1.14\text{ V}$.

Table 310 • SPI Characteristics for All Devices

Symbol	Description	Min	Typ	Max	Unit	Conditions
SPIFMAX	Maximum operating frequency of SPI interface			20	MHz	
sp1	SPI_[0 1]_CLK minimum period					
	SPI_[0 1]_CLK = PCLK/2	12			ns	
	SPI_[0 1]_CLK = PCLK/4	24.1			ns	
	SPI_[0 1]_CLK = PCLK/8	48.2			ns	
	SPI_[0 1]_CLK = PCLK/16	0.1			μs	
	SPI_[0 1]_CLK = PCLK/32	0.19			μs	
	SPI_[0 1]_CLK = PCLK/64	0.39			μs	
SPI_[0 1]_CLK = PCLK/128	0.77			μs		

Table 310 • SPI Characteristics for All Devices (continued)

Symbol	Description	Min	Typ	Max	Unit	Conditions
sp2	SPI_[0 1]_CLK minimum pulse width high					
	SPI_[0 1]_CLK = PCLK/2	6			ns	
	SPI_[0 1]_CLK = PCLK/4	12.05			ns	
	SPI_[0 1]_CLK = PCLK/8	24.1			ns	
	SPI_[0 1]_CLK = PCLK/16	0.05			µs	
	SPI_[0 1]_CLK = PCLK/32	0.095			µs	
	SPI_[0 1]_CLK = PCLK/64	0.195			µs	
	SPI_[0 1]_CLK = PCLK/128	0.385			µs	
sp3	SPI_[0 1]_CLK minimum pulse width low					
	SPI_[0 1]_CLK = PCLK/2	6			ns	
	SPI_[0 1]_CLK = PCLK/4	12.05			ns	
	SPI_[0 1]_CLK = PCLK/8	24.1			ns	
	SPI_[0 1]_CLK = PCLK/16	0.05			µs	
	SPI_[0 1]_CLK = PCLK/32	0.095			µs	
	SPI_[0 1]_CLK = PCLK/64	0.195			µs	
	SPI_[0 1]_CLK = PCLK/128	0.385			µs	
sp4	SPI_[0 1]_CLK, SPI_[0 1]_DO, SPI_[0 1]_SS rise time (10%–90%) ¹		2.77		ns	I/O Configuration: LVCMOS 2.5 V - 8 mA AC loading: 35 pF test conditions: Typical voltage, 25 °C
sp5	SPI_[0 1]_CLK, SPI_[0 1]_DO, SPI_[0 1]_SS fall time (10%–90%) ¹		2.906		ns	I/O Configuration: LVCMOS 2.5 V - 8 mA AC loading: 35 pF test conditions: Typical voltage, 25 °C
SPI master configuration (applicable for 005, 010, 025, and 050 devices)						
sp6m	SPI_[0 1]_DO setup time ²	(SPI_x_CLK_period/2) – 8.0			ns	
sp7m	SPI_[0 1]_DO hold time ²	(SPI_x_CLK_period/2) – 2.5			ns	
sp8m	SPI_[0 1]_DI setup time ²	12			ns	
sp9m	SPI_[0 1]_DI hold time ²	2.5			ns	
SPI slave configuration (applicable for 005, 010, 025, and 050 devices)						
sp6s	SPI_[0 1]_DO setup time ²	(SPI_x_CLK_period/2) – 17.0			ns	
sp7s	SPI_[0 1]_DO hold time ²	(SPI_x_CLK_period/2) + 3.0			ns	
sp8s	SPI_[0 1]_DI setup time ²	2			ns	
sp9s	SPI_[0 1]_DI hold time ²	7			ns	

Table 310 • SPI Characteristics for All Devices (continued)

Symbol	Description	Min	Typ	Max	Unit	Conditions
SPI master configuration (applicable for 060, 090, and 150 devices)						
sp6m	SPI_[0 1]_DO setup time ²	(SPI_x_CLK_period/2) – 7.0			ns	
sp7m	SPI_[0 1]_DO hold time ²	(SPI_x_CLK_period/2) – 9.5			ns	
sp8m	SPI_[0 1]_DI setup time ²	15			ns	
sp9m	SPI_[0 1]_DI hold time ²	–2.5			ns	
SPI slave configuration (applicable for 060, 090, and 150 devices)						
sp6s	SPI_[0 1]_DO setup time ²	(SPI_x_CLK_period/2) – 16.0			ns	
sp7s	SPI_[0 1]_DO hold time ²	(SPI_x_CLK_period/2) – 3.5			ns	
sp8s	SPI_[0 1]_DI setup time ²	3			ns	
sp9s	SPI_[0 1]_DI hold time ²	2.5			ns	

1. For specific Rise/Fall Times board design considerations and detailed output buffer resistances, use the corresponding IBIS models located on the Microsemi SoC Products Group website: <http://www.microsemi.com/soc/download/ibis/default.aspx>.
2. For allowable pclk configurations, see the Serial Peripheral Interface Controller section in the *UG0331: SmartFusion2 Microcontroller Subsystem User Guide*.

Figure 23 • SPI Timing for a Single Frame Transfer in Motorola Mode (SPH = 1)

OUR CERTIFICATE

DiGi provide top-quality products and perfect service for customer worldwide through standardization, technological innovation and continuous improvement. DiGi through third-party certification, we stricly control the quality of products and services. Welcome your RFQ to

Email: Info@DiGi-Electronics.com



Tel: +00 852-30501935

RFQ Email: Info@DiGi-Electronics.com

DiGi is a global authorized distributor of electronic components.