

MCP1711T-22I/OT Datasheet

www.digi-electronics.com

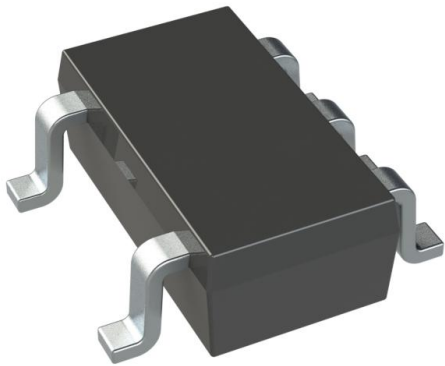

<https://www.DiGi-Electronics.com>

| | |
|------------------------------|--|
| DiGi Electronics Part Number | MCP1711T-22I/OT-DG |
| Manufacturer | Microchip Technology |
| Manufacturer Product Number | MCP1711T-22I/OT |
| Description | IC REG LINEAR 2.2V 150MA SOT23-5 |
| Detailed Description | Linear Voltage Regulator IC Positive Fixed 1 Output 150mA SOT-23-5 |



Tel: +00 852-30501935

RFQ Email: Info@DiGi-Electronics.com

DiGi is a global authorized distributor of electronic components.

Purchase and inquiry

Manufacturer Product Number:

MCP1711T-22I/OT

Series:

-

Output Configuration:

Positive

Number of Regulators:

1

Voltage - Output (Min/Fixed):

2.2V

Voltage Dropout (Max):

1.05V @ 150mA

Current - Quiescent (Iq):

1.27 μ A

PSRR:

-

Protection Features:

-

Mounting Type:

Surface Mount

Supplier Device Package:

SOT-23-5

Manufacturer:

Microchip Technology

Product Status:

Active

Output Type:

Fixed

Voltage - Input (Max):

6V

Voltage - Output (Max):

-

Current - Output:

150mA

Current - Supply (Max):

1.8 μ A

Control Features:

Enable

Operating Temperature:

-40°C ~ 85°C

Package / Case:

SC-74A, SOT-753

Base Product Number:

MCP1711

Environmental & Export classification

RoHS Status:

ROHS3 Compliant

REACH Status:

REACH Unaffected

HTSUS:

8542.39.0001

Moisture Sensitivity Level (MSL):

1 (Unlimited)

ECCN:

EAR99



MCP1711

150 mA Ultra-Low Quiescent Current, Capacitorless LDO Regulator

Features

- Low Quiescent Current: 600 nA
- Input Voltage Range: 1.4V to 6.0V
- Standard Output Voltages: 1.2V, 1.8V, 1.9V, 2.0V, 2.2V, 2.5V, 3.0V, 3.3V, 5.0V
- Output Accuracy: ± 20 mV for 1.2V and 1.8V Options and $\pm 1\%$ for $V_R \geq 2.0V$
- Temperature Stability: ± 50 ppm/ $^{\circ}C$
- Maximum Output Current: 150 mA
- Low ON Resistance: 3.3Ω @ $V_R = 3.0V$
- Standby Current: 10 nA
- Protection Circuits: Current Limiter, Short Circuit, Foldback
- SHDN Pin Function: ON/OFF Logic = Enable High
- C_{OUT} Discharge Circuit when SHDN Function is Active
- Output Capacitor: Low Equivalent Series Resistance (ESR) Ceramic, Capacitorless Compatible
- Operating Temperature: $-40^{\circ}C$ to $+85^{\circ}C$ (Industrial)
- Available Packages:
 - 4-Lead 1 x 1 mm UQFN
 - 5-Lead SOT-23
- Environmentally Friendly: EU RoHS Compliant, Lead-Free

Applications

- Energy Harvesting
- Long-Life, Battery-Powered Applications
- Portable Electronics
- Ultra-Low Consumption "Green" Products
- Mobile Devices/Terminals
- Wireless LAN
- Modules (Wireless, Cameras)

Related Literature

- **AN765**, *Using Microchip's Micropower LDOs* (DS00765), Microchip Technology Inc.
- **AN766**, *Pin-Compatible CMOS Upgrades to Bipolar LDOs* (DS00766), Microchip Technology Inc.
- **AN792**, *A Method to Determine How Much Power a SOT23 Can Dissipate in an Application* (DS00792), Microchip Technology Inc.

General Description

The MCP1711 is a highly accurate CMOS low dropout (LDO) voltage regulator that can deliver up to 150 mA of current while consuming only 0.6 μA of quiescent current (typical). The input operating range is specified from 1.4V to 6.0V, making it an ideal choice for mobile applications and one-cell Li-Ion powered applications.

The MCP1711 is capable of delivering 150 mA output current with only 0.32V (typical) for $V_R = 5.0V$, and 1.41V (typical) for $V_R = 1.2V$ of input-to-output voltages differential. The output voltage accuracy of the MCP1711 is typically $\pm 0.02V$ for $V_R < 2.0V$ and $\pm 1\%$ for $V_R \geq 2.0V$ at $+25^{\circ}C$. The temperature stability is approximately ± 50 ppm/ $^{\circ}C$. Line regulation is $\pm 0.01\%/V$ typical at $+25^{\circ}C$.

The output voltages available for the MCP1711 range from 1.2V to 5.0V. The LDO output is stable even if an output capacitor is not connected, due to an excellent internal phase compensation. However, for better transient responses, the output capacitor should be added. The MCP1711 is compatible with low ESR ceramic output capacitors.

Overcurrent limit and short-circuit protection embedded into the device provide a robust solution for any application.

The MCP1711 has a true current foldback feature. When the load decreases beyond the MCP1711 load rating, the output current and output voltage will foldback toward 80 mA (typical) at approximately 0V output. When the load impedance increases and returns to the rated load, the MCP1711 will follow the same foldback curve as the device comes out of current foldback.

If the device is in Shutdown mode, by inputting a low-level signal to the SHDN pin, the current consumption is reduced to less than 0.1 μA (typically 0.01 μA). In Shutdown mode, if the output capacitor is used, it will be discharged via the internal dedicated switch and, as a result, the output voltage quickly returns to 0V.

The package options for the MCP1711 are the 4-lead 1 x 1 mm UQFN and the 5-lead SOT-23, which make the device ideal for small and compact applications.

MCP1711

Package Types

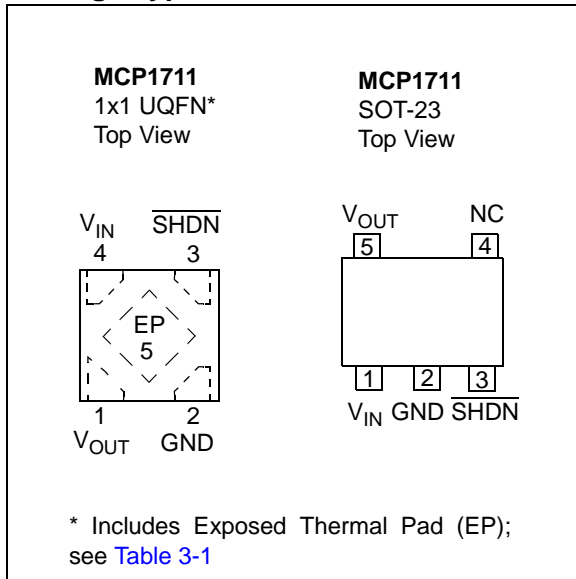

Typical Application Circuit

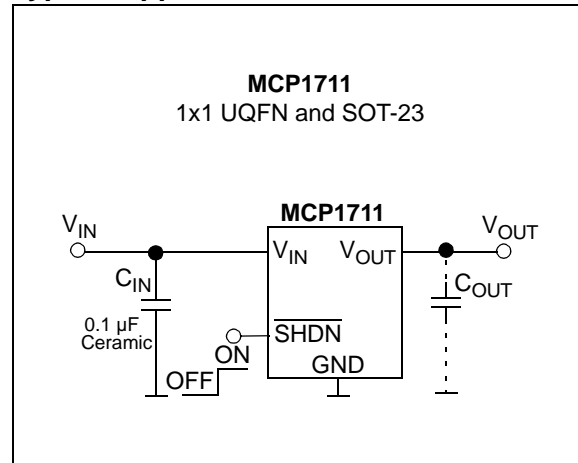

Functional Block Diagram

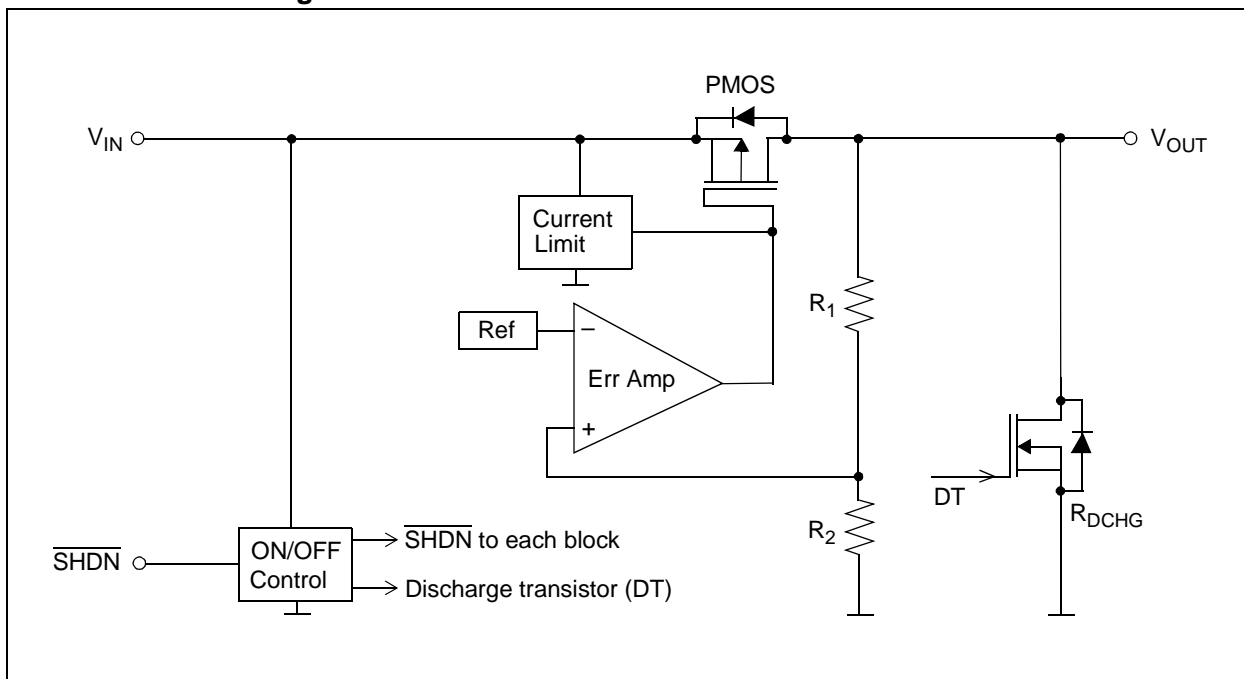

1.0 ELECTRICAL CHARACTERISTICS**Absolute Maximum Ratings †**

| | |
|--|---|
| Input Voltage, V_{IN} | +6.5V |
| V_{IN}, \overline{SHDN} | -0.3V to +6.5V |
| Output Current, I_{OUT} ⁽¹⁾ | 470mA |
| Output Voltage, V_{OUT} ⁽²⁾ | -0.3V to $V_{IN} + 0.3V$ or +6.5V |
| Power Dissipation | |
| 5-Lead SOT-23 | 600 mW (JEDEC 51-7 FR-4 board with thermal vias) or 250 mW ⁽³⁾ |
| 4-Lead 1 x 1 mm UQFN..... | 550 mW (JEDEC 51-7 FR-4 board with thermal vias) or 100 mW ⁽³⁾ |
| Storage Temperature | -55°C to +125°C |
| Operating Ambient Temperature..... | -40°C to +85°C |
| ESD Protection on all pins | ±1 kV HBM, ±200V MM |

† **Notice:** Stresses above those listed under “Absolute Maximum Ratings” may cause permanent damage to the device. This is a stress rating only and functional operation of the device at those or any other conditions above those indicated in the operational sections of this specification is not intended. Exposure to maximum rating conditions for extended periods may affect device reliability.

Note 1: Provided that the device is used in the range of $I_{OUT} \leq P_D / (V_{IN} - V_{OUT})$.

2: The maximum rating corresponds to the lowest value between $V_{IN} + 0.3V$ or +6.5V.

3: The device is mounted on one layer PCB with minimal copper that does not provide any additional cooling.

DC CHARACTERISTICS

Electrical Characteristics: Unless otherwise indicated, $V_{\overline{SHDN}} = V_{IN}$, $I_{OUT} = 1$ mA, $C_{IN} = C_{OUT} = 0$ μ F, $V_{IN} = 3.5V$ for $V_R < 2.5V$ and $V_{IN} = V_R + 1V$ for $V_R \geq 2.5V$, $T_A = +25^\circ C$

| Parameters | Sym. | Min. | Typ. | Max. | Units | Conditions |
|---------------------------------------|---|-------------------|----------------------------|-------------------|---------|---|
| Input-Output Characteristics | | | | | | |
| Input Voltage | V_{IN} | 1.4 | — | 6.0 | V | $I_{OUT} = 1$ μ A |
| Output Voltage | V_{OUT} | $V_R - 0.02$ | V_R | $V_R + 0.02$ | V | $V_R < 2.0V$ |
| | | $V_R \times 0.99$ | V_R | $V_R \times 1.01$ | | $V_R \geq 2.0V$ |
| Maximum Output Current | I_{OUT} | 150 | — | — | mA | |
| Load Regulation | ΔV_{OUT} | -16 | ±3 | +16 | mV | $1 \mu A \leq I_{OUT} \leq 1$ mA |
| | | -50 | ±17 | +50 | | 1 mA $\leq I_{OUT} \leq 150$ mA |
| Dropout Voltage ⁽¹⁾ | $V_{DROPOUT1}$ | — | V_{DROP1} ⁽²⁾ | | V | $I_{OUT} = 50$ mA |
| | $V_{DROPOUT2}$ | — | V_{DROP2} ⁽²⁾ | | | $I_{OUT} = 150$ mA |
| Input Quiescent Current | I_q | — | 0.60 | 1.27 | μ A | $V_R < 1.9V$ |
| | | — | 0.65 | 1.50 | | $1.9V \leq V_R < 4.0V$ |
| | | — | 0.80 | 1.80 | | $V_R \geq 4.0V$ |
| Input Quiescent Current for SHDN mode | $I_{\overline{SHDN}}$ | — | 0.01 | 0.10 | μ A | $V_{IN} = 6.0V$ $V_{\overline{SHDN}} = V_{IN}$ |
| Line Regulation | $\frac{\Delta V_{OUT}}{(\Delta V_{IN} \times V_{OUT})}$ | -0.13 | ±0.01 | +0.13 | %V | $I_{OUT} = 1$ μ A $V_R + 0.5V \leq V_{IN} \leq 6.0V$ |
| | | -0.19 | ±0.01 | +0.19 | | $I_{OUT} = 1$ mA $V_R \geq 1.2V, V_R + 0.5V \leq V_{IN} \leq 6.0V$ |

Note 1: The dropout voltage is defined as the input to output differential at which the output voltage drops 2% below the output voltage value that was measured with an applied input voltage of $V_{IN} = V_R + 1V$.

2: V_{DROP1} , V_{DROP2} : Dropout Voltage (Refer to the [DC Characteristics Voltage Table](#)).

MCP1711

DC CHARACTERISTICS (CONTINUED)

Electrical Characteristics: Unless otherwise indicated, $V_{\overline{\text{SHDN}}} = V_{\text{IN}}$, $I_{\text{OUT}} = 1 \text{ mA}$, $C_{\text{IN}} = C_{\text{OUT}} = 0 \mu\text{F}$, $V_{\text{IN}} = 3.5\text{V}$ for $V_{\text{R}} < 2.5\text{V}$ and $V_{\text{IN}} = V_{\text{R}} + 1\text{V}$ for $V_{\text{R}} \geq 2.5\text{V}$, $T_{\text{A}} = +25^{\circ}\text{C}$

| Parameters | Sym. | Min. | Typ. | Max. | Units | Conditions |
|--|--|------|------|------|---------------------------|---|
| Output Voltage Temperature Stability | $\frac{\Delta V_{\text{OUT}}}{(\Delta T \times V_{\text{OUT}})}$ | — | ±50 | — | ppm/°C | $I_{\text{OUT}} = 10 \text{ mA}$ $-40^{\circ}\text{C} \leq T_{\text{A}} \leq +85^{\circ}\text{C}$ |
| Current Limit | I_{LIMIT} | 150 | 270 | — | mA | $V_{\text{OUT}} = 0.95 \times V_{\text{R}}$ |
| Output Short-Circuit Foldback Current | $I_{\text{OUT_SC}}$ | — | 80 | — | mA | $V_{\text{OUT}} = \text{GND}$ |
| C_{OUT} Auto-Discharge Resistance | R_{DCHG} | 280 | 450 | 640 | Ω | $\overline{\text{SHDN}} = \text{GND}$ $V_{\text{OUT}} = V_{\text{R}}$ |
| Noise | e_{n} | — | 30 | — | $\mu\text{V}(\text{rms})$ | $C_{\text{IN}} = C_{\text{OUT}} = 1 \mu\text{F}$, $I_{\text{OUT}} = 50 \text{ mA}$, $f = 10 \text{ Hz to } 100 \text{ kHz}$ |
| Shutdown Input | | | | | | |
| SHDN Logic High Input Voltage | $V_{\overline{\text{SHDN}}\text{-HIGH}}$ | 0.91 | — | 6.00 | V | |
| SHDN Logic Low Input Voltage | $V_{\overline{\text{SHDN}}\text{-LOW}}$ | 0 | — | 0.38 | V | |
| SHDN High-Level Current | $I_{\overline{\text{SHDN}}\text{-HIGH}}$ | -0.1 | — | +0.1 | μA | $V_{\text{IN}} = 6.0\text{V}$ |
| SHDN Low-Level Current | $I_{\overline{\text{SHDN}}\text{-LOW}}$ | -0.1 | — | +0.1 | μA | $V_{\text{IN}} = 6.0\text{V}$ $\overline{\text{SHDN}} = \text{GND}$ |

Note 1: The dropout voltage is defined as the input to output differential at which the output voltage drops 2% below the output voltage value that was measured with an applied input voltage of $V_{\text{IN}} = V_{\text{R}} + 1\text{V}$.

2: V_{DROP1} , V_{DROP2} : Dropout Voltage (Refer to the [DC Characteristics Voltage Table](#)).

DC CHARACTERISTICS VOLTAGE TABLE

| Nominal Output Voltage | Output Voltage (V) | | Dropout Voltage (V) | | | |
|------------------------|--------------------|--------|---------------------|--------------------|--------------------|--------------------|
| | V_{OUT} | | V_{DROP1} | V_{DROP1} | V_{DROP2} | V_{DROP2} |
| V_{R} (V) | Min. | Max. | Typ. | Max. | Typ. | Max. |
| 1.2 | 1.1800 | 1.2200 | 0.87 | 1.23 | 1.41 | 1.93 |
| 1.8 | 1.7800 | 1.8200 | 0.47 | 0.72 | 0.99 | 1.40 |
| 1.9 | 1.8800 | 1.9200 | 0.42 | 0.64 | 0.92 | 1.29 |
| 2.0 | 1.9800 | 2.0200 | 0.37 | 0.58 | 0.86 | 1.20 |
| 2.2 | 2.1780 | 2.2220 | 0.31 | 0.47 | 0.75 | 1.05 |
| 2.5 | 2.4750 | 2.5250 | 0.26 | 0.40 | 0.67 | 0.92 |
| 3.0 | 2.9700 | 3.0300 | 0.17 | 0.26 | 0.50 | 0.67 |
| 3.3 | 3.2670 | 3.3330 | 0.17 | 0.26 | 0.50 | 0.67 |
| 5.0 | 4.9500 | 5.0500 | 0.10 | 0.16 | 0.32 | 0.43 |

TEMPERATURE SPECIFICATIONS (Note 1)

| Parameters | Sym. | Min. | Typ. | Max. | Units | Conditions |
|-------------------------------------|---------------|------|--------|------|-------|--|
| Temperature Ranges | | | | | | |
| Operating Ambient Temperature Range | T_A | -40 | — | +85 | °C | |
| Junction Operating Temperature | T_J | -40 | — | +125 | °C | |
| Storage Temperature Range | T_A | -55 | — | +125 | °C | |
| Package Thermal Resistances | | | | | | |
| Thermal Resistance, 1 x 1 UQFN-4Ld | θ_{JA} | — | 181.82 | — | °C/W | JEDEC 51-7 FR4 board with thermal vias |
| | θ_{JA} | — | 1000 | — | °C/W | Note 2 |
| | θ_{JC} | — | 15 | — | °C/W | |
| Thermal Resistance, SOT-23-5Ld | θ_{JA} | — | 166.67 | — | °C/W | JEDEC 51-7 FR4 board with thermal vias |
| | θ_{JA} | — | 400 | — | °C/W | Note 2 |
| | θ_{JC} | — | 81 | — | °C/W | |

- Note 1:** The maximum allowable power dissipation is a function of ambient temperature, the maximum allowable junction temperature, and the thermal resistance from junction to air (i.e., T_A , T_J , θ_{JA}). Exceeding the maximum allowable power dissipation will cause the device operating junction temperature to exceed the maximum +125°C rating. Sustained junction temperatures above +125°C can impact the device reliability.
- 2:** The device is mounted on one layer PCB with minimal copper that does not provide any additional cooling.

MCP1711

2.0 TYPICAL PERFORMANCE CURVES

Note: The graphs and tables provided following this note are a statistical summary based on a limited number of samples and are provided for informational purposes only. The performance characteristics listed herein are not tested or guaranteed. In some graphs or tables, the data presented may be outside the specified operating range (e.g., outside specified power supply range) and therefore outside the warranted range.

NOTE: Unless otherwise indicated, $V_{IN} = 3.5V$ for $V_R < 2.5V$ or $V_{IN} = V_R + 1V$ for $V_R \geq 2.5V$, $I_{OUT} = 1\text{ mA}$, $C_{IN} = C_{OUT} = 0\text{ }\mu\text{F}$, $V_{SHDN} = V_{IN}$, $T_A = +25^\circ\text{C}$.

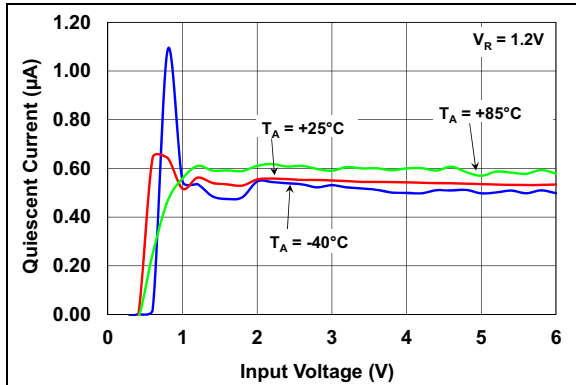

FIGURE 2-1: Quiescent Current vs. Input Voltage.

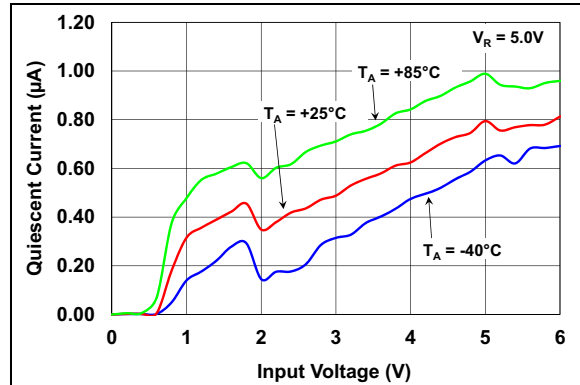

FIGURE 2-4: Quiescent Current vs. Input Voltage.

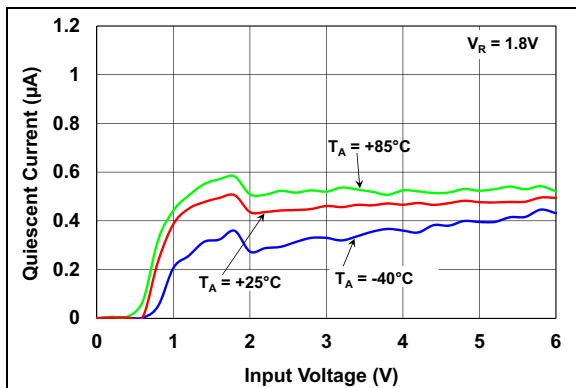

FIGURE 2-2: Quiescent Current vs. Input Voltage.

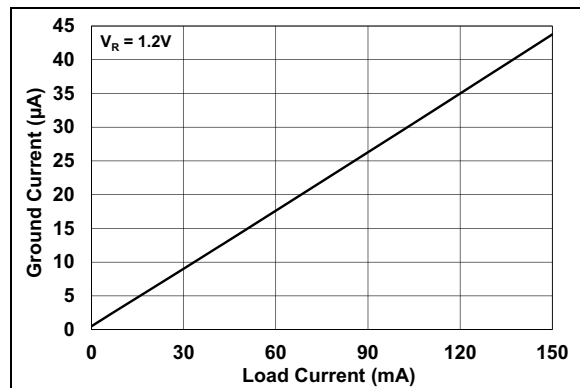

FIGURE 2-5: Ground Current vs. Load Current.

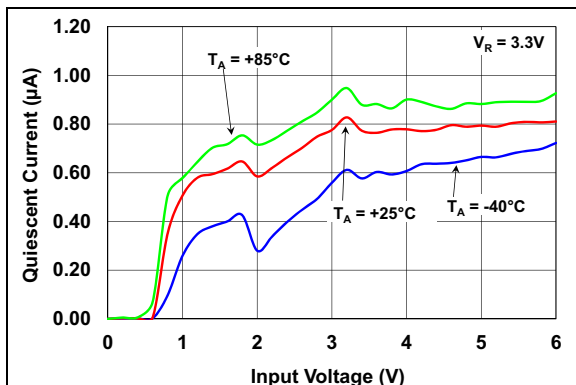

FIGURE 2-3: Quiescent Current vs. Input Voltage.

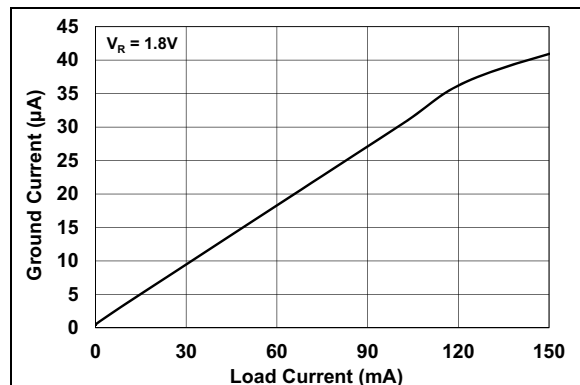

FIGURE 2-6: Ground Current vs. Load Current.

MCP1711

Note: Unless otherwise indicated, $V_{IN} = 3.5V$ for $V_R < 2.5V$ or $V_{IN} = V_R + 1V$ for $V_R \geq 2.5V$, $I_{OUT} = 1\text{ mA}$, $C_{IN} = C_{OUT} = 0\text{ }\mu\text{F}$, $V_{SHDN} = V_{IN}$, $T_A = +25^\circ\text{C}$.

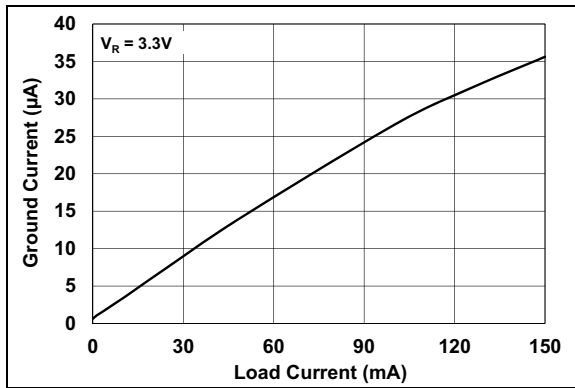

FIGURE 2-7: Ground Current vs. Load Current.

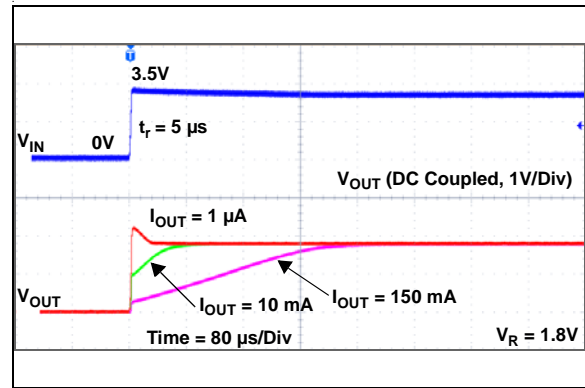

FIGURE 2-10: Start-Up from V_{IN} .

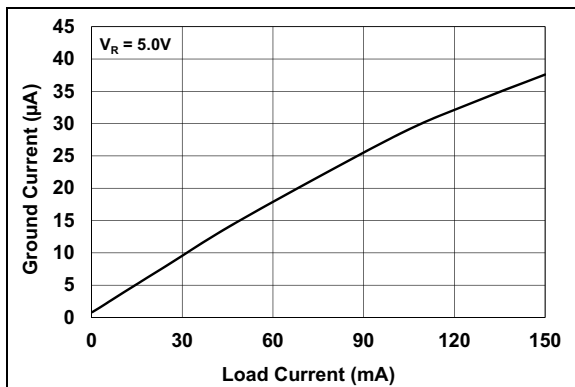

FIGURE 2-8: Ground Current vs. Load Current.

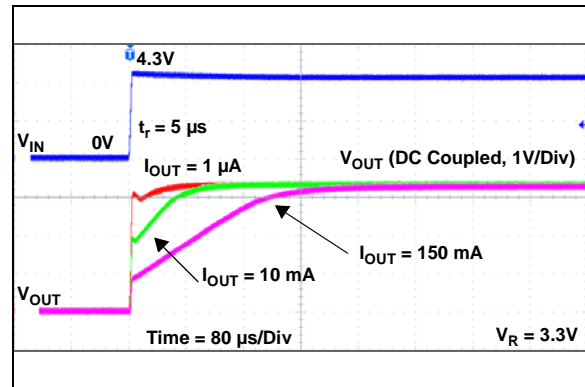

FIGURE 2-11: Start-Up from V_{IN} .

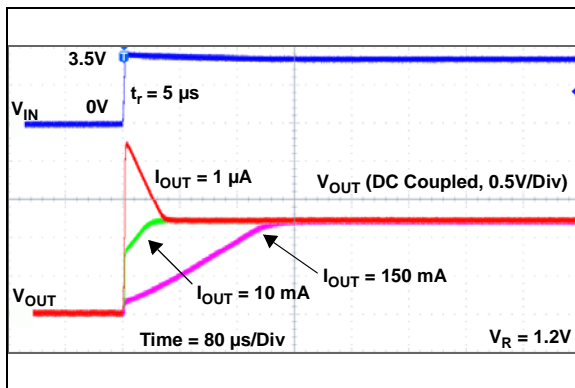

FIGURE 2-9: Start-Up from V_{IN} .

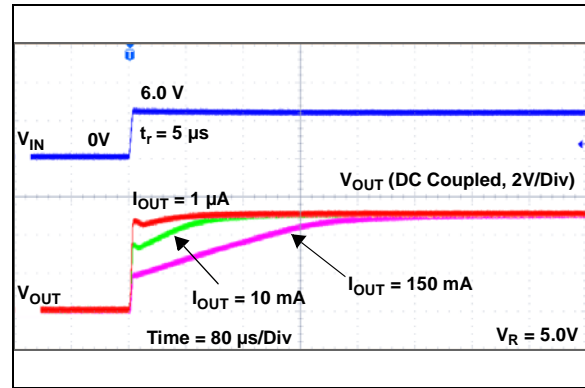

FIGURE 2-12: Start-Up from V_{IN} .

MCP1711

Note: Unless otherwise indicated, $V_{IN} = 3.5V$ for $V_R < 2.5V$ or $V_{IN} = V_R + 1V$ for $V_R \geq 2.5V$, $I_{OUT} = 1 mA$, $C_{IN} = C_{OUT} = 0 \mu F$, $V_{SHDN} = V_{IN}$, $T_A = +25^\circ C$.

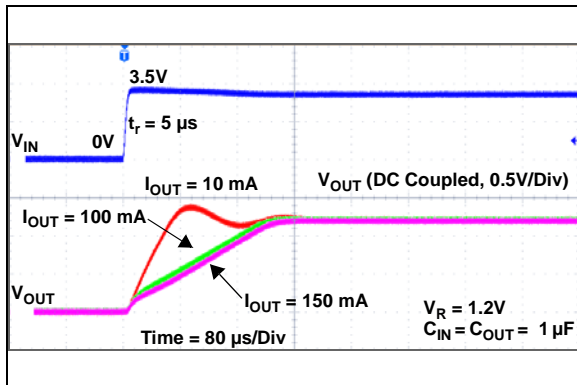

FIGURE 2-13: Start-Up from V_{IN} .

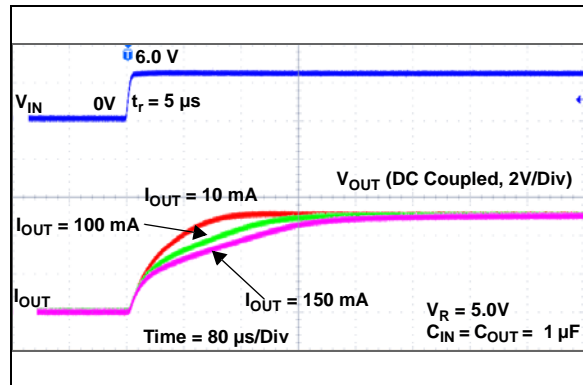

FIGURE 2-16: Start-Up from V_{IN} .

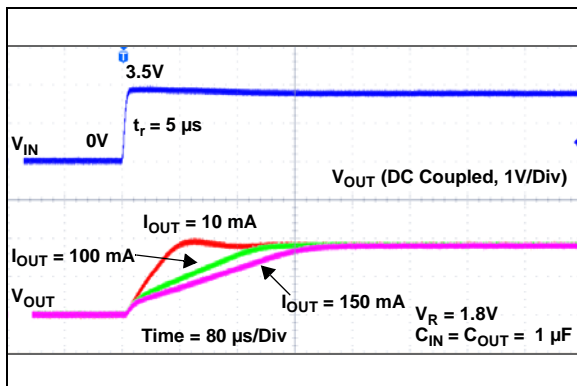

FIGURE 2-14: Start-Up from V_{IN} .

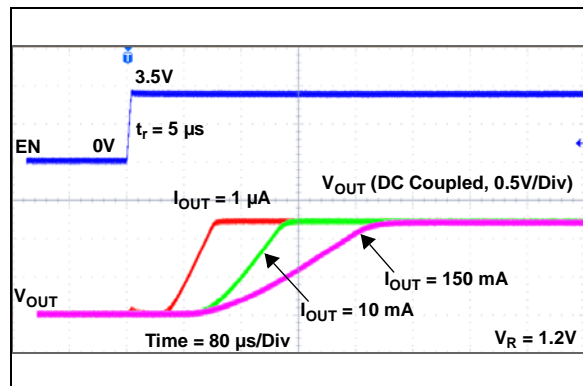

FIGURE 2-17: Start-Up from SHDN.

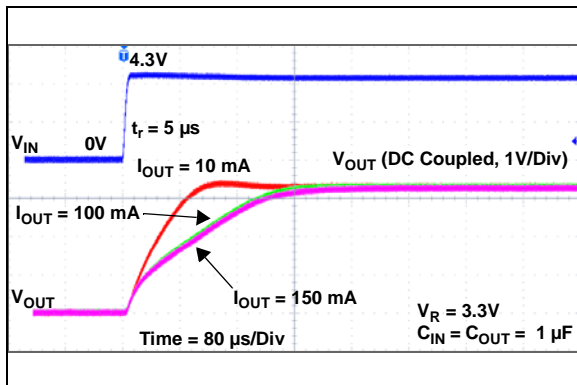

FIGURE 2-15: Start-Up from V_{IN} .

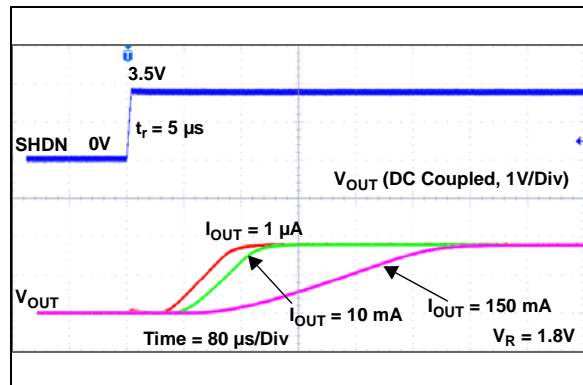

FIGURE 2-18: Start-Up from SHDN.

MCP1711

Note: Unless otherwise indicated, $V_{IN} = 3.5V$ for $V_R < 2.5V$ or $V_{IN} = V_R + 1V$ for $V_R \geq 2.5V$, $I_{OUT} = 1\text{ mA}$, $C_{IN} = C_{OUT} = 0\text{ }\mu\text{F}$, $V_{SHDN} = V_{IN}$, $T_A = +25^\circ\text{C}$.

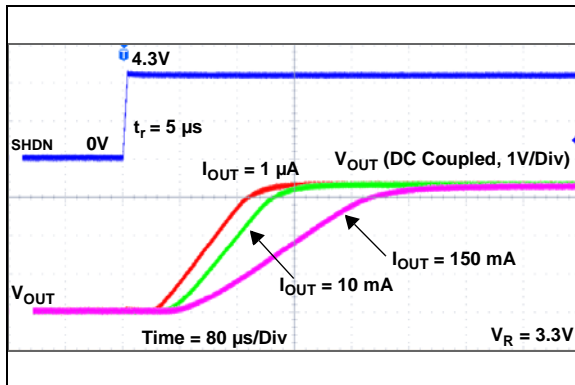

FIGURE 2-19: Start-Up from SHDN.

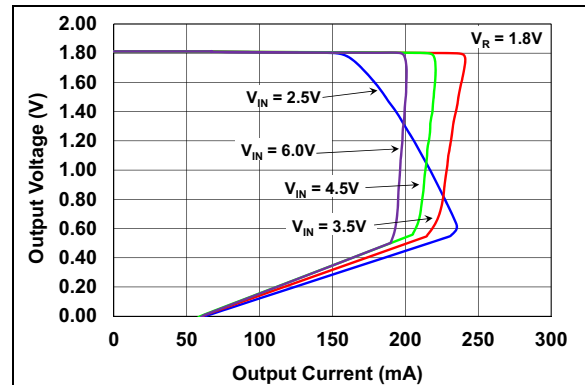

FIGURE 2-22: Output Voltage vs. Output Current.

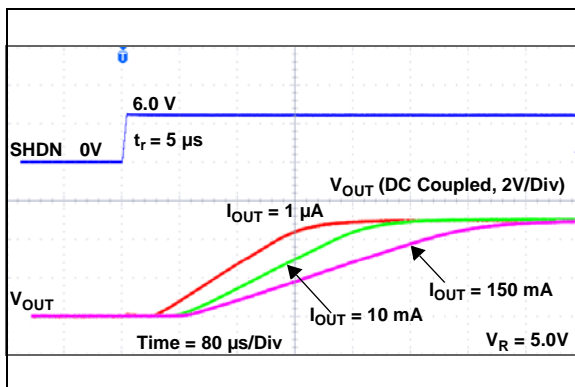

FIGURE 2-20: Start-Up from SHDN.

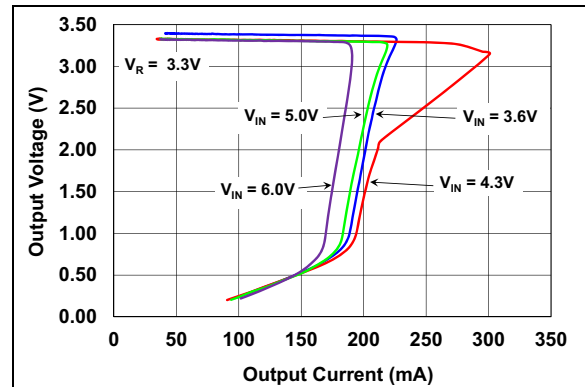

FIGURE 2-23: Output Voltage vs. Output Current.

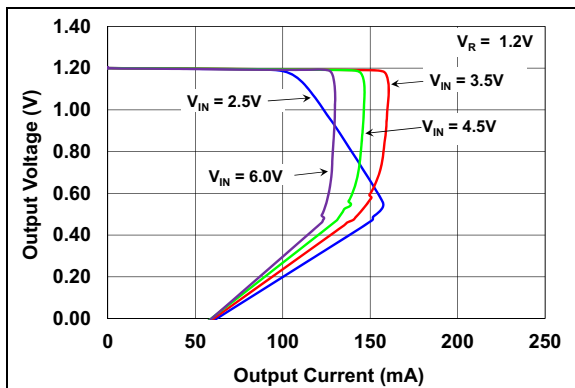

FIGURE 2-21: Output Voltage vs. Output Current.

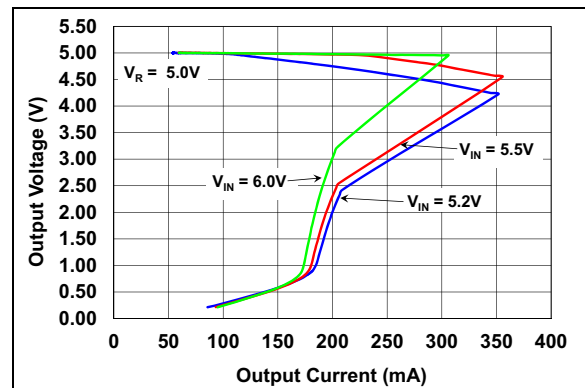

FIGURE 2-24: Output Voltage vs. Output Current.

MCP1711

Note: Unless otherwise indicated, $V_{IN} = 3.5V$ for $V_R < 2.5V$ or $V_{IN} = V_R + 1V$ for $V_R \geq 2.5V$, $I_{OUT} = 1\text{ mA}$, $C_{IN} = C_{OUT} = 0\text{ }\mu\text{F}$, $V_{SHDN} = V_{IN}$, $T_A = +25^\circ\text{C}$.

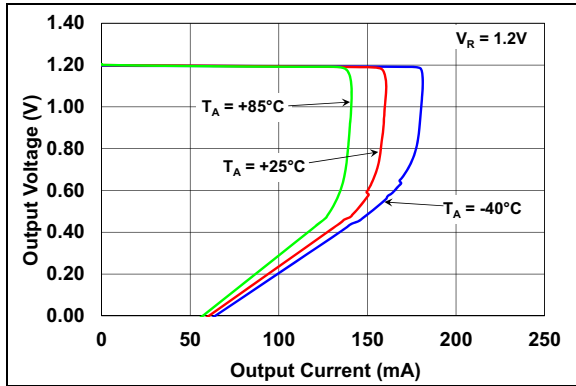

FIGURE 2-25: Output Voltage vs. Output Current.

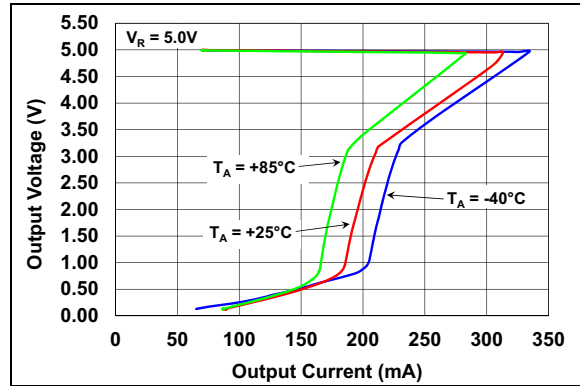

FIGURE 2-28: Output Voltage vs. Output Current.

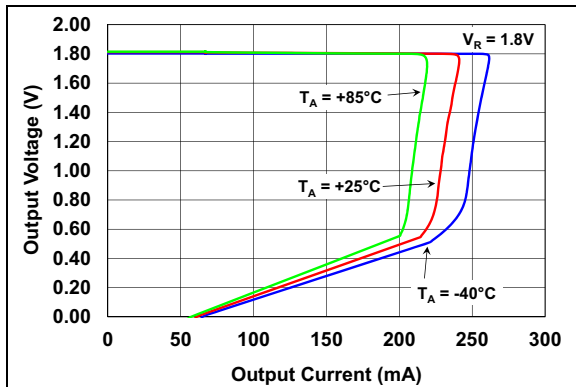

FIGURE 2-26: Output Voltage vs. Output Current.

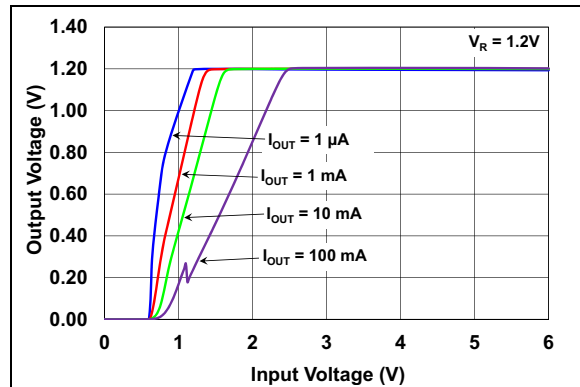

FIGURE 2-29: Output Voltage vs. Input Voltage.

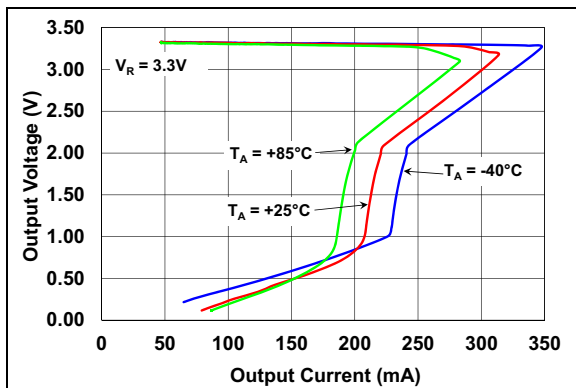

FIGURE 2-27: Output Voltage vs. Output Current.

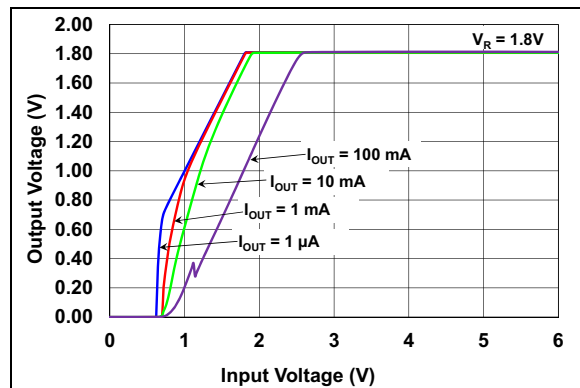

FIGURE 2-30: Output Voltage vs. Input Voltage.

MCP1711

Note: Unless otherwise indicated, $V_{IN} = 3.5V$ for $V_R < 2.5V$ or $V_{IN} = V_R + 1V$ for $V_R \geq 2.5V$, $I_{OUT} = 1\text{ mA}$, $C_{IN} = C_{OUT} = 0\text{ }\mu\text{F}$, $V_{SHDN} = V_{IN}$, $T_A = +25^\circ\text{C}$.

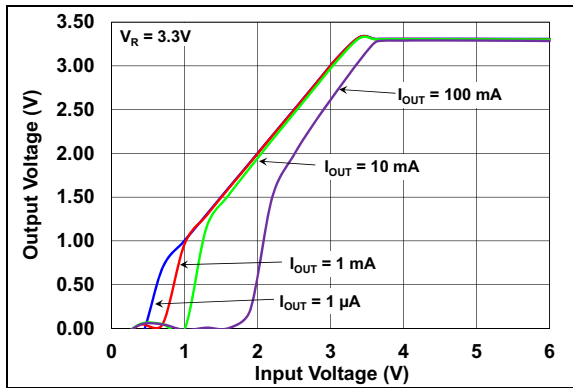

FIGURE 2-31: Output Voltage vs. Input Voltage.

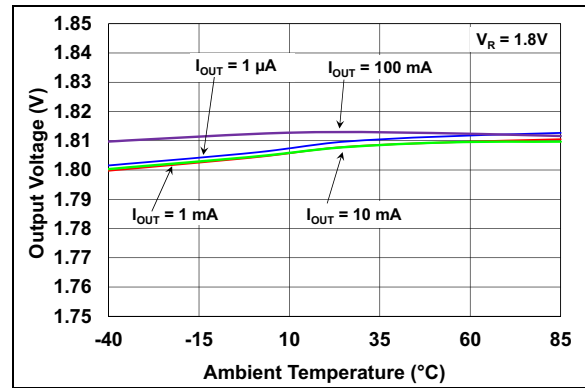

FIGURE 2-34: Output Voltage vs. Ambient Temperature.

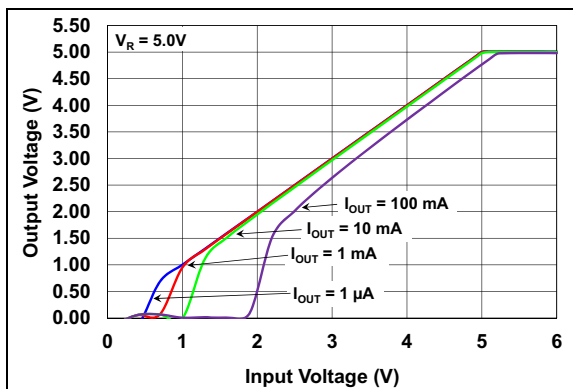

FIGURE 2-32: Output Voltage vs. Input Voltage.

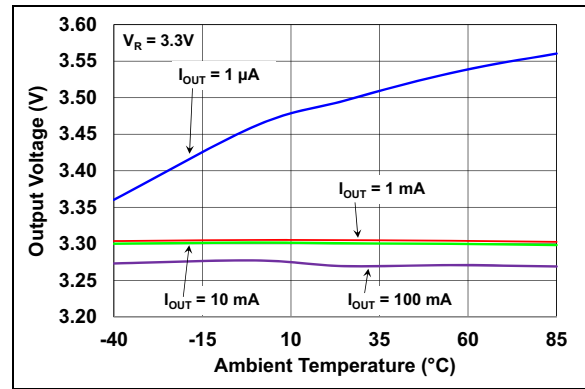

FIGURE 2-35: Output Voltage vs. Ambient Temperature.

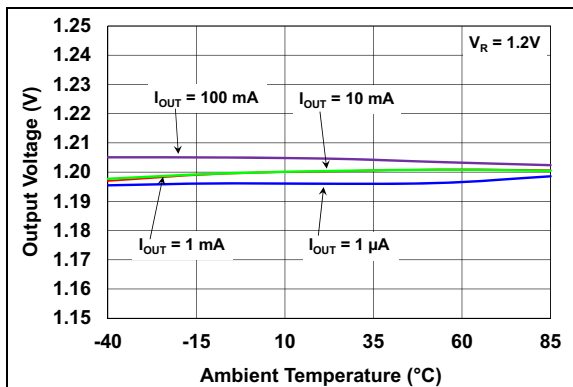

FIGURE 2-33: Output Voltage vs. Ambient Temperature.

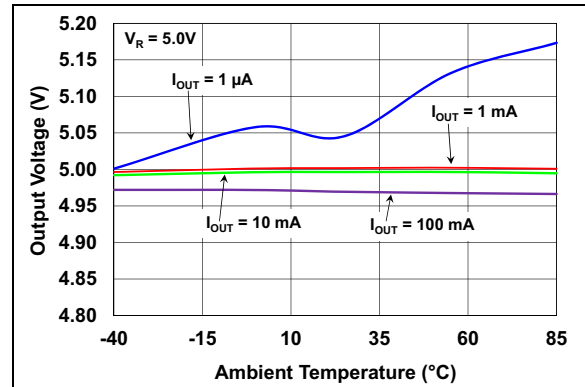

FIGURE 2-36: Output Voltage vs. Ambient Temperature.

MCP1711

Note: Unless otherwise indicated, $V_{IN} = 3.5V$ for $V_R < 2.5V$ or $V_{IN} = V_R + 1V$ for $V_R \geq 2.5V$, $I_{OUT} = 1\text{ mA}$, $C_{IN} = C_{OUT} = 0\text{ }\mu\text{F}$, $V_{SHDN} = V_{IN}$, $T_A = +25^\circ\text{C}$.

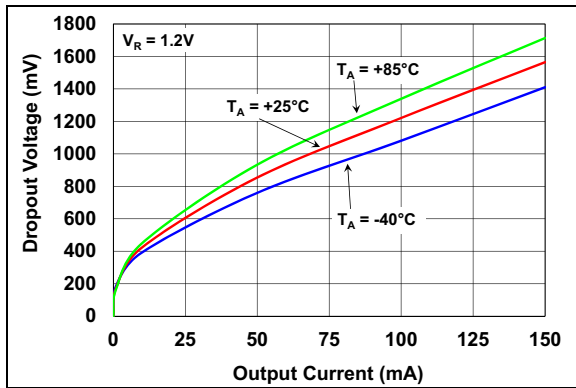

FIGURE 2-37: Dropout Voltage vs. Output Current.

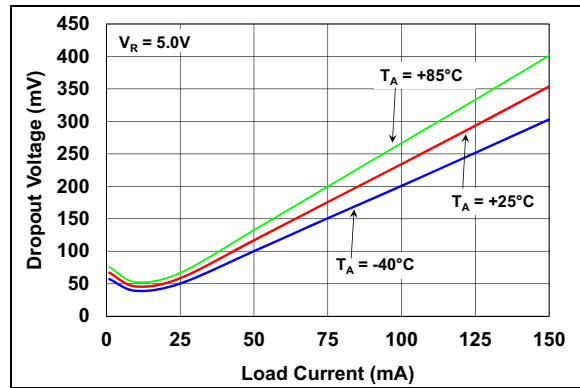

FIGURE 2-40: Dropout Voltage vs. Output Current.

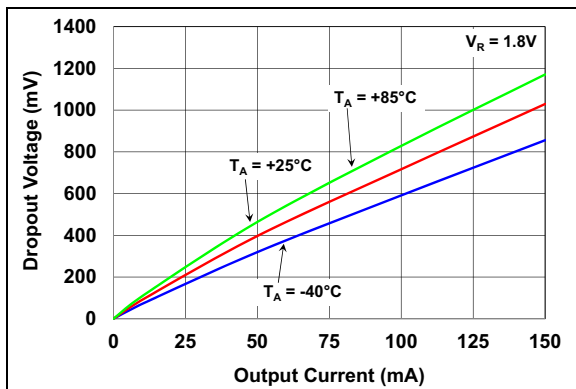

FIGURE 2-38: Dropout Voltage vs. Output Current.

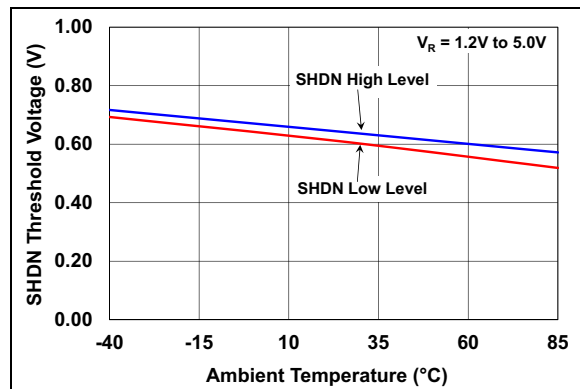

FIGURE 2-41: Shutdown Threshold Voltage vs. Ambient Temperature.

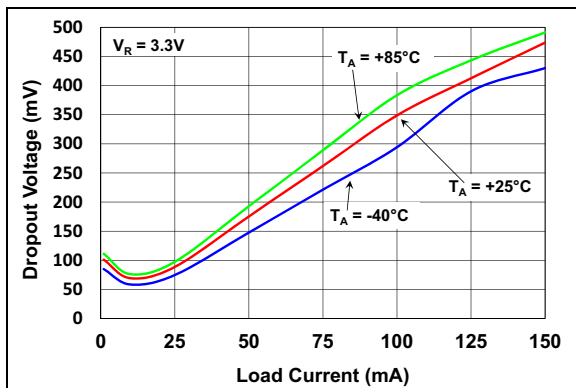

FIGURE 2-39: Dropout Voltage vs. Output Current.

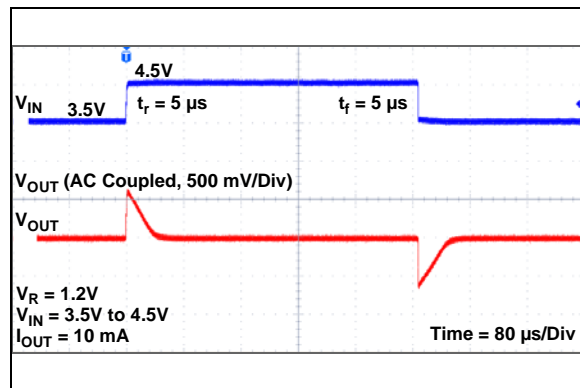

FIGURE 2-42: Dynamic Line Response.

MCP1711

Note: Unless otherwise indicated, $V_{IN} = 3.5V$ for $V_R < 2.5V$ or $V_{IN} = V_R + 1V$ for $V_R \geq 2.5V$, $I_{OUT} = 1\text{ mA}$, $C_{IN} = C_{OUT} = 0\text{ }\mu\text{F}$, $V_{SHDN} = V_{IN}$, $T_A = +25^\circ\text{C}$.

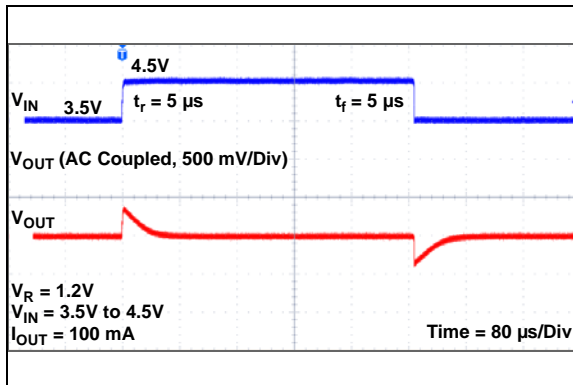

FIGURE 2-43: Dynamic Line Response.

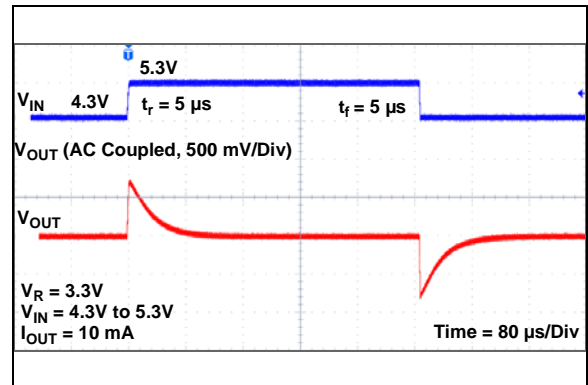

FIGURE 2-46: Dynamic Line Response.

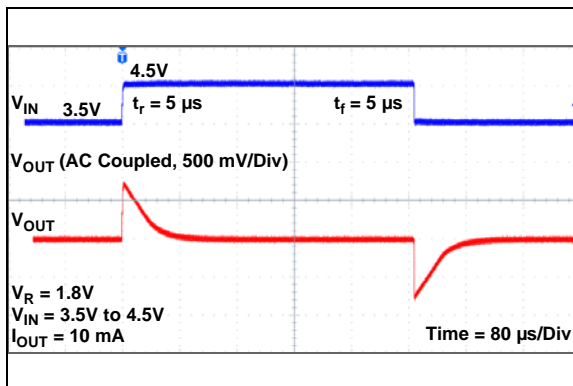

FIGURE 2-44: Dynamic Line Response.

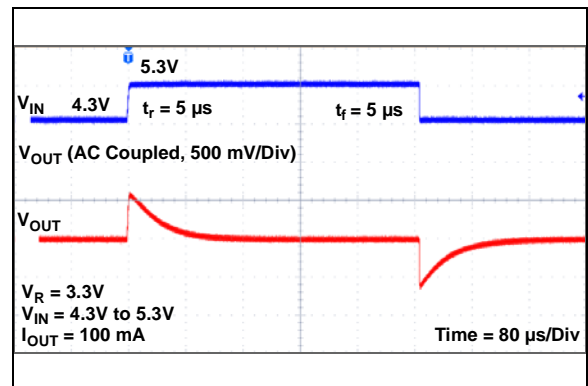

FIGURE 2-47: Dynamic Line Response.

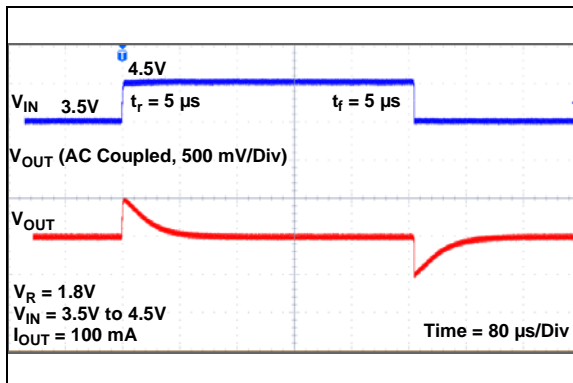

FIGURE 2-45: Dynamic Line Response.

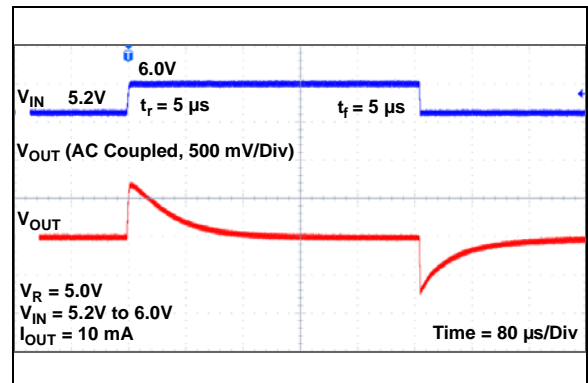

FIGURE 2-48: Dynamic Line Response.

MCP1711

Note: Unless otherwise indicated, $V_{IN} = 3.5V$ for $V_R < 2.5V$ or $V_{IN} = V_R + 1V$ for $V_R \geq 2.5V$, $I_{OUT} = 1 mA$, $C_{IN} = C_{OUT} = 0 \mu F$, $V_{SHDN} = V_{IN}$, $T_A = +25^\circ C$.

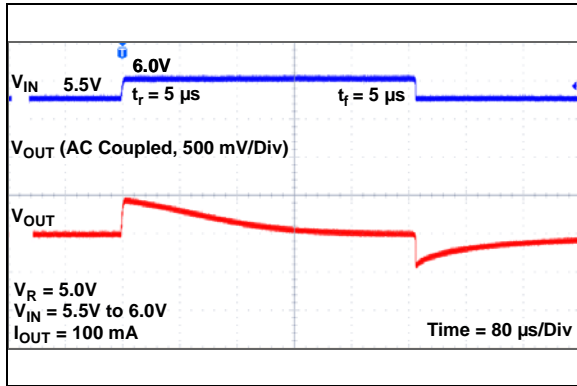

FIGURE 2-49: Dynamic Line Response.

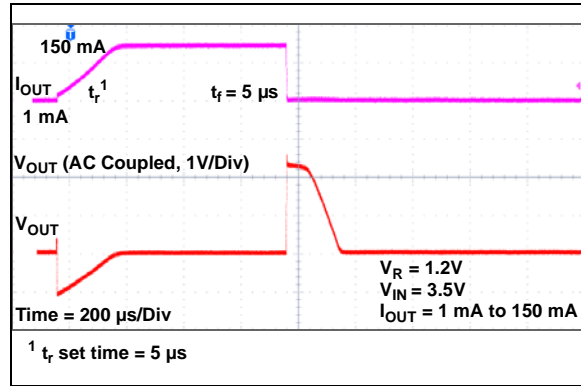

FIGURE 2-52: Dynamic Load Response.

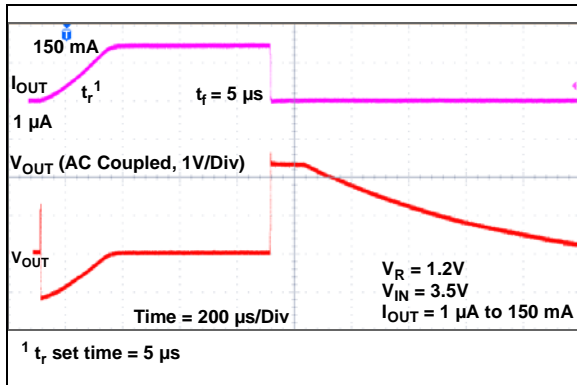

FIGURE 2-50: Dynamic Load Response.

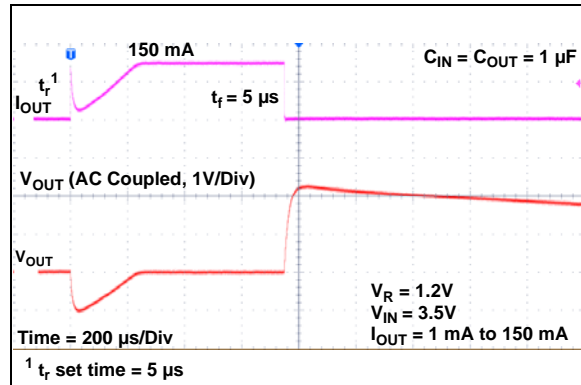

FIGURE 2-53: Dynamic Load Response.

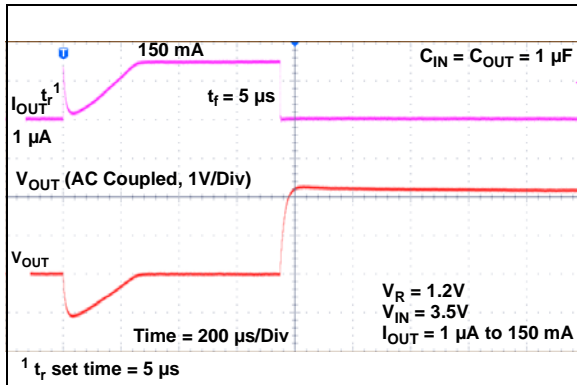

FIGURE 2-51: Dynamic Load Response.

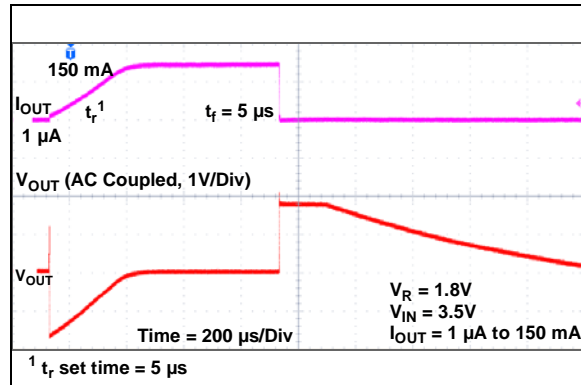

FIGURE 2-54: Dynamic Load Response.

MCP1711

Note: Unless otherwise indicated, $V_{IN} = 3.5V$ for $V_R < 2.5V$ or $V_{IN} = V_R + 1V$ for $V_R \geq 2.5V$, $I_{OUT} = 1\text{ mA}$, $C_{IN} = C_{OUT} = 0\text{ }\mu\text{F}$, $V_{SHDN} = V_{IN}$, $T_A = +25^\circ\text{C}$.

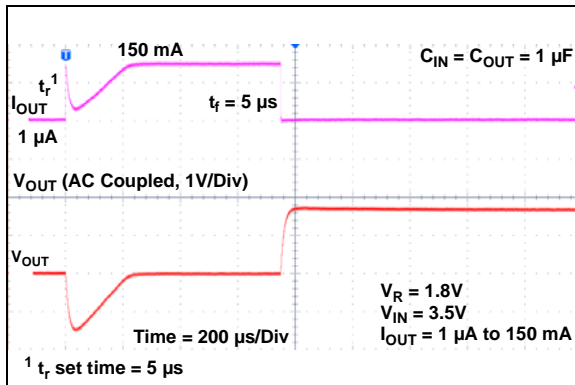

FIGURE 2-55: Dynamic Load Response.

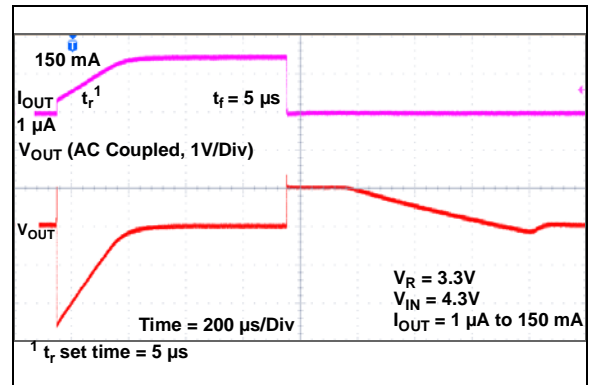

FIGURE 2-58: Dynamic Load Response.

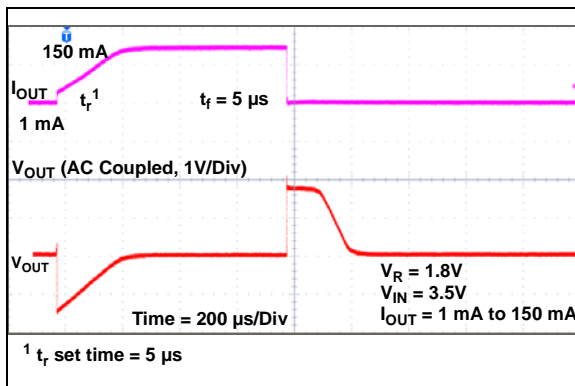

FIGURE 2-56: Dynamic Load Response.

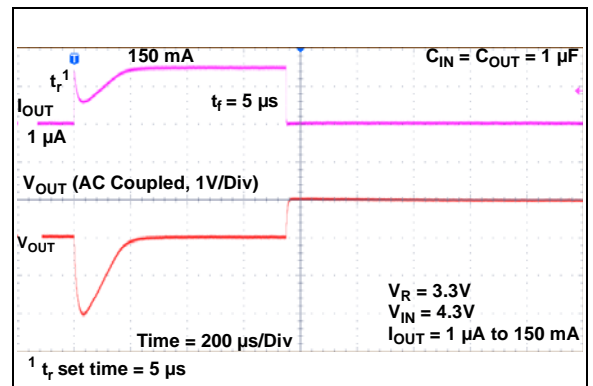

FIGURE 2-59: Dynamic Load Response.

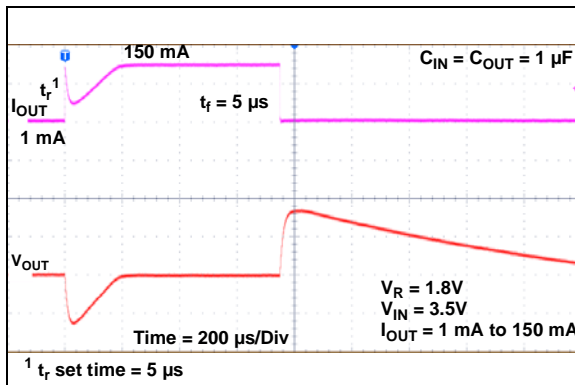

FIGURE 2-57: Dynamic Load Response.

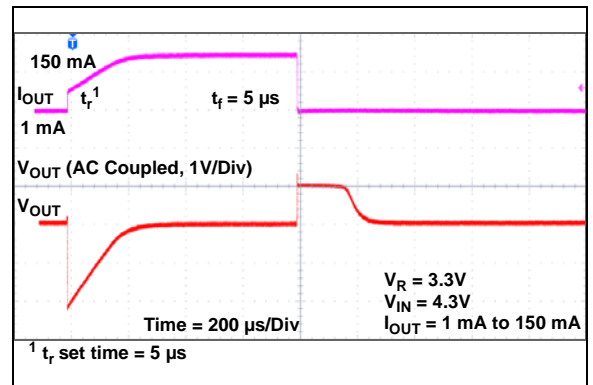

FIGURE 2-60: Dynamic Load Response.

MCP1711

Note: Unless otherwise indicated, $V_{IN} = 3.5V$ for $V_R < 2.5V$ or $V_{IN} = V_R + 1V$ for $V_R \geq 2.5V$, $I_{OUT} = 1 mA$, $C_{IN} = C_{OUT} = 0 \mu F$, $V_{SHDN} = V_{IN}$, $T_A = +25^\circ C$.

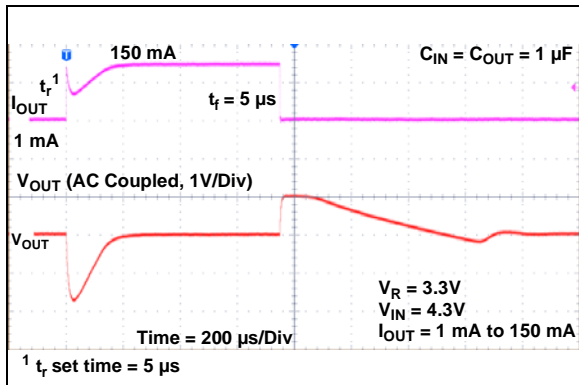

FIGURE 2-61: Dynamic Load Response.

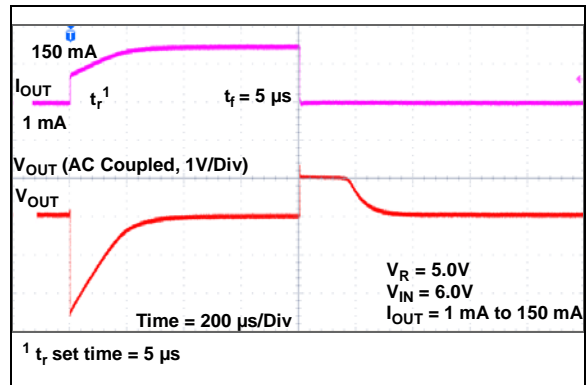

FIGURE 2-64: Dynamic Load Response.

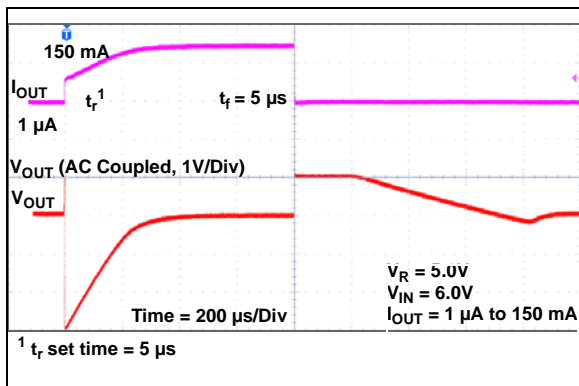

FIGURE 2-62: Dynamic Load Response.

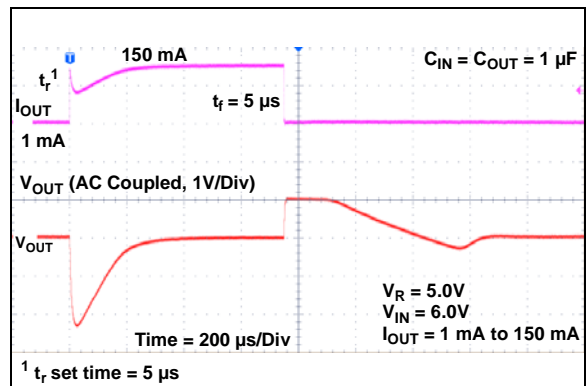

FIGURE 2-65: Dynamic Load Response.

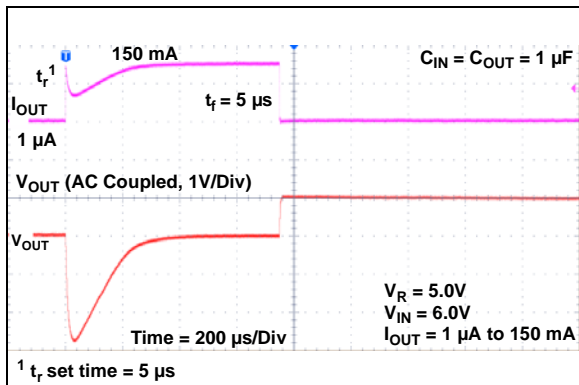

FIGURE 2-63: Dynamic Load Response.

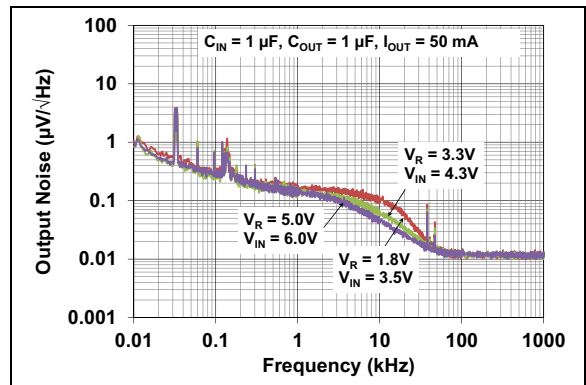

FIGURE 2-66: Output Noise vs. Frequency.

MCP1711

Note: Unless otherwise indicated, $V_{IN} = 3.5V$ for $V_R < 2.5V$ or $V_{IN} = V_R + 1V$ for $V_R \geq 2.5V$, $I_{OUT} = 1\text{ mA}$, $C_{IN} = C_{OUT} = 0\text{ }\mu\text{F}$, $V_{SHDN} = V_{IN}$, $T_A = +25^\circ\text{C}$.

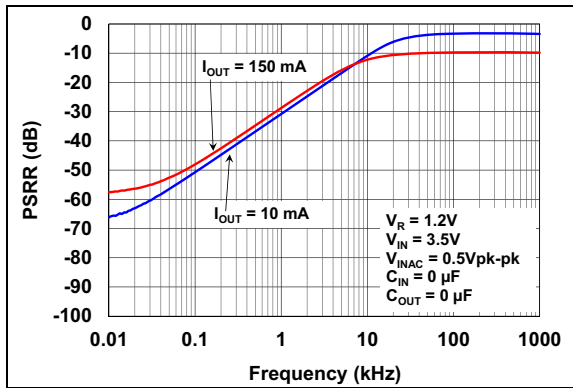

FIGURE 2-67: Power Supply Ripple Rejection vs. Frequency.

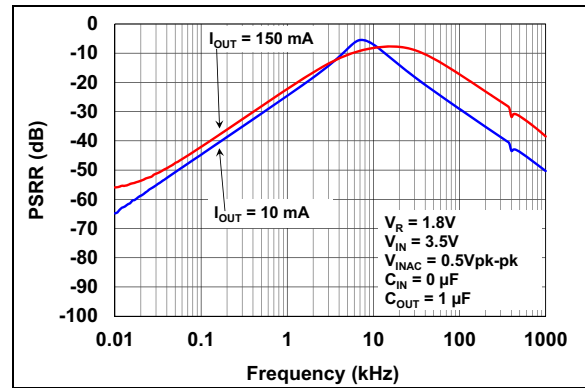

FIGURE 2-70: Power Supply Ripple Rejection vs. Frequency.

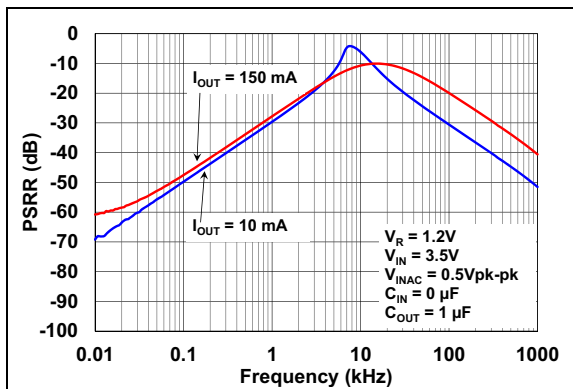

FIGURE 2-68: Power Supply Ripple Rejection vs. Frequency.

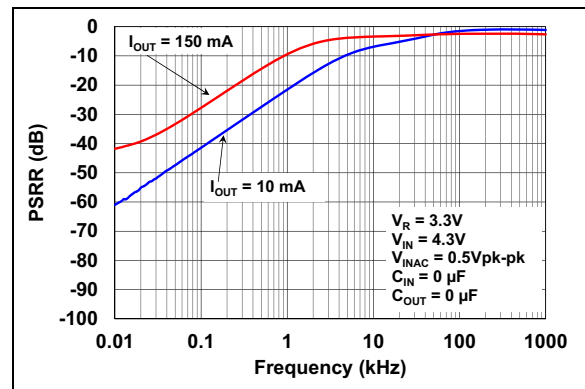

FIGURE 2-71: Power Supply Ripple Rejection vs. Frequency.

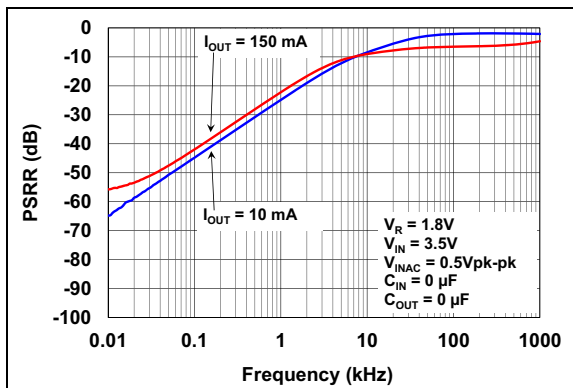

FIGURE 2-69: Power Supply Ripple Rejection vs. Frequency.

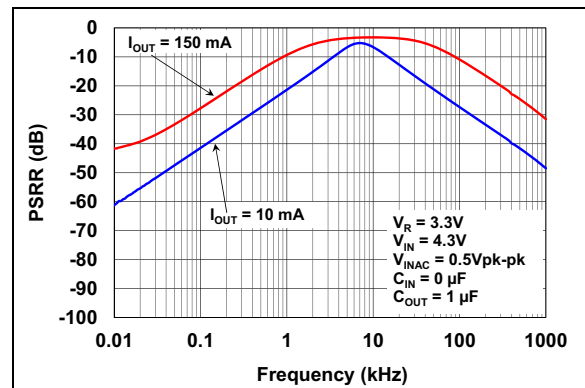

FIGURE 2-72: Power Supply Ripple Rejection vs. Frequency.

MCP1711

Note: Unless otherwise indicated, $V_{IN} = 3.5V$ for $V_R < 2.5V$ or $V_{IN} = V_R + 1V$ for $V_R \geq 2.5V$, $I_{OUT} = 1\text{ mA}$, $C_{IN} = C_{OUT} = 0\text{ }\mu\text{F}$, $V_{SHDN} = V_{IN}$, $T_A = +25^\circ\text{C}$.

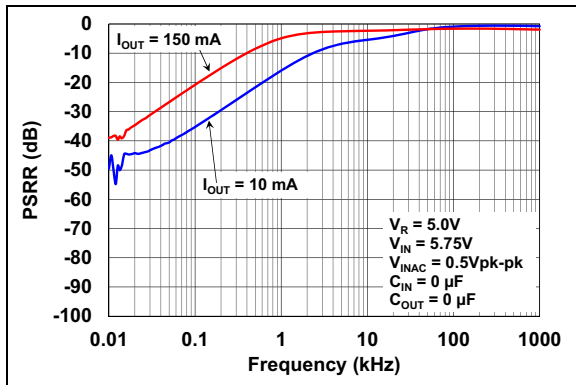

FIGURE 2-73: Power Supply Ripple Rejection vs. Frequency.

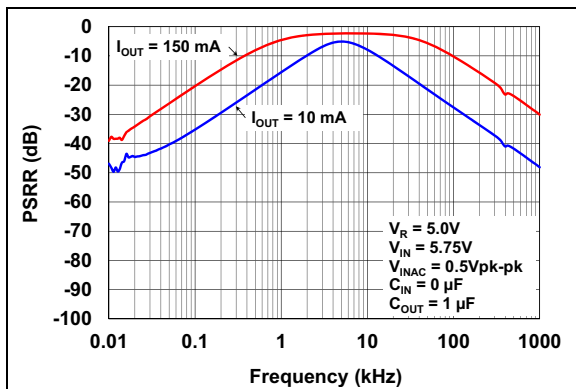

FIGURE 2-74: Power Supply Ripple Rejection vs. Frequency.

3.0 PIN DESCRIPTIONS

The descriptions of the pins are listed in [Table 3-1](#).

TABLE 3-1: PIN FUNCTION TABLE

| MCP1711 1X1 UQFN | MCP1711 SOT-23 | Symbol | Description |
|---------------------|-------------------|--------------------------|--|
| 4 | 1 | V_{IN} | Unregulated Input Supply Voltage |
| 2 | 2 | GND | Ground Terminal |
| 3 | 3 | $\overline{\text{SHDN}}$ | Shutdown Input |
| — | 4 | NC | Not Connected (SOT-23 only) |
| 1 | 5 | V_{OUT} | Regulated Voltage Output |
| 5 | — | EP | Exposed Thermal Pad (1x1 UQFN only) |

3.1 Unregulated Input Voltage (V_{IN})

Connect the V_{IN} pin to the output of the unregulated source voltage. Like all low dropout linear regulators, low-source impedance is necessary for ensuring stable operation of the LDO. The amount of capacitance required to ensure low-source impedance will depend on the proximity of the input source capacitors or battery type. For most applications, 0.1 μF of capacitance will ensure stable operation of the LDO circuit. If the output capacitor is used, the input capacitor should have a capacitance value equal to or greater than the output capacitor for performance applications.

The input capacitor will supply the load current during transients and improve performance. For applications that have low load currents, the input capacitance requirement can be lowered.

The type of capacitor used may be ceramic, tantalum or aluminum electrolytic. The low ESR characteristics of the ceramic will yield better noise and Power Supply Rejection Ratio (PSRR) performance at high frequency.

3.2 Ground Terminal (GND)

This is the regulator ground. Tie GND to the negative side of the output capacitor (if used) and to the negative side of the input capacitor. Only the LDO bias current flows out of this pin, so there is no high current. The LDO output regulation is referenced to this pin. Minimize voltage drops between this pin and the negative side of the load. If a PCB ground plane is not used, minimize the length of the trace between the GND pin and the ground line.

3.3 Shutdown Input ($\overline{\text{SHDN}}$)

The $\overline{\text{SHDN}}$ input is used to turn the LDO output voltage on and off.

When the $\overline{\text{SHDN}}$ input is at logic High level, the LDO output voltage is enabled. When the $\overline{\text{SHDN}}$ pin is pulled to a logic Low level, the LDO output voltage is disabled. When the $\overline{\text{SHDN}}$ pin is pulled low, the V_{OUT} pin is pulled down to the ground level via, parallel to the feedback resistors (R_1 and R_2), and the C_{OUT} discharge resistance (R_{DCHG}).

The output voltage becomes unstable when the $\overline{\text{SHDN}}$ pin is left floating.

3.4 Not Connected Pin (NC)

The SOT-23 package has a pin that is not connected. This pin should be either left floating or tied to the ground plane.

3.5 Regulated Output Voltage (V_{OUT})

Connect the V_{OUT} pin to the positive side of the load and to the positive side of the output capacitor (if used). The positive side of the output capacitor should be physically located as close as possible to the LDO V_{OUT} pin. The current flowing out of this pin is equal to the DC load current.

3.6 Exposed Thermal Pad (EP)

The 4-lead 1 x 1 UQFN package has an exposed metal pad on the bottom of the package. The exposed metal pad gives the device better thermal characteristics by providing a good thermal path to either a PCB isolated plane or a PCB ground plane. The exposed pad of the package is not internally connected to GND.

MCP1711

4.0 DEVICE OVERVIEW

The MCP1711 device is a 150 mA output current, low-dropout (LDO) voltage regulator. The low dropout voltage at high current makes it ideal for battery-powered applications. The input voltage ranges from 1.4V to 6.0V. Unlike other high output current LDOs, the MCP1711 typically draws only 600 nA quiescent current and maximum 45 μ A ground current at 150 mA load. MCP1711 has a shutdown control input pin (SHDN). The output voltage options are fixed.

4.1 LDO Output Voltage

The MCP1711 LDO has a fixed output voltage. The output voltage range is 1.2V to 5.0V.

4.2 Output Current and Current Limiting

The MCP1711 is tested and ensured to supply a maximum of 150 mA of output current. The device can provide a highly accurate output voltage even if the output current is only 1 μ A (very light load).

The MCP1711 also features a true output current fold-back. If an excessive load, due to a low impedance short-circuit condition at the output load, is detected, the output current and voltage will fold back towards 80 mA and 0V, respectively. The output voltage and current will resume normal levels when the excessive load is removed. If the overload condition is a soft overload, the MCP1711 will supply higher load currents of up to 270 mA typical. This allows for device usage in applications that have pulsed load currents having an average output current value of 150 mA or less.

4.3 Output Capacitor

The MCP1711 can provide a stable output voltage even without an additional output capacitor due to its excellent internal phase compensation, so that a minimum output capacitance is not required. In order to improve the load step response and PSRR, an output capacitor can be added. A value in the range of 0.1 μ F to 1.0 μ F is recommended for most applications. The capacitor should be placed as close as possible to the V_{OUT} pin and the GND pin. The device is compatible with low ESR ceramic capacitors. Ceramic materials like X7R and X5R have low temperature coefficients and are well within the acceptable ESR range required. A typical 1 μ F X7R 0805 capacitor has an ESR of 50 m Ω .

4.4 Input Capacitor

Low-input source impedance is necessary for the LDO output to operate properly. When operating from batteries, or in applications with long lead length (> 10 inches) between the input source and the LDO, some input capacitance is recommended. A minimum of 0.1 μ F to 1.0 μ F is recommended for most applications. For applications that have output step load requirements, the input capacitance of the LDO is very important. The input capacitance provides the LDO with a good local low-impedance source to pull the transient current from, so it responds quickly to the output load step. For good step response performance, the input capacitor should be of an equivalent or higher value than the output capacitor. The capacitor should be placed as close to the input of the LDO as is practical. Larger input capacitors will also help reduce any high-frequency noise on the input and output of the LDO as well as reduce the effects of any inductance that exists between the input source voltage and the input capacitance of the LDO.

4.5 Shutdown Input ($\overline{\text{SHDN}}$)

The MCP1711 internal circuitry can be shut down via the signal from the $\overline{\text{SHDN}}$ pin. The $\overline{\text{SHDN}}$ input is an active-low input signal that turns the LDO on and off. The shutdown threshold is a fixed voltage level. The minimum value of this shutdown threshold required to turn the output on is 0.91V. The maximum value required to turn the output off is 0.38V.

In Shutdown mode, the V_{OUT} pin will be pulled down to the ground level via, parallel to feedback resistors and C_{OUT} discharge resistance R_{DCHG} . In this state, the application is protected from a glitch operation caused by the electric charge at the output capacitor. Moreover, the discharge time of the output capacitor is set by the C_{OUT} auto-discharge resistance (R_{DCHG}) and the output capacitor C_{OUT} . By setting the time constant of a C_{OUT} auto-discharge resistance value (R_{DCHG}) and the output capacitor value (C_{OUT}) as $\tau = C_{\text{OUT}} \times R_{\text{DCHG}}$, the output voltage after discharge via the internal switch is calculated using [Equation 4-1](#):

Note: The R_{DCHG} depends on V_{IN} ; when V_{IN} is high the R_{DCHG} is low.

EQUATION 4-1:

$$V_{\text{OUT}}(t) = V_{\text{OUT}} \times e^{(-t/\tau)}$$

or

$$t = \tau \times \ln(V_{\text{OUT}}/V_{\text{OUT}}(t))$$

Where:

$V_{\text{OUT}}(t)$ = The output voltage during discharging

V_{OUT} = The initial output voltage

t = Discharge time

$\tau = C_{\text{OUT}} \times R_{\text{DCHG}}$

4.6 Dropout Voltage

Dropout Voltage is defined as the input-to-output voltage differential at which the output voltage drops 2% below the nominal value that was measured with a $V_{\text{R}} + 1.0\text{V}$ differential applied. See [Section 1.0 “Electrical Characteristics”](#), for minimum and maximum voltage specifications.

MCP1711

5.0 APPLICATION CIRCUITS AND ISSUES

5.1 Typical Application

The MCP1711 is most commonly used as a voltage regulator. Its low quiescent current and low dropout voltage make it ideal for a multitude of battery-powered applications.

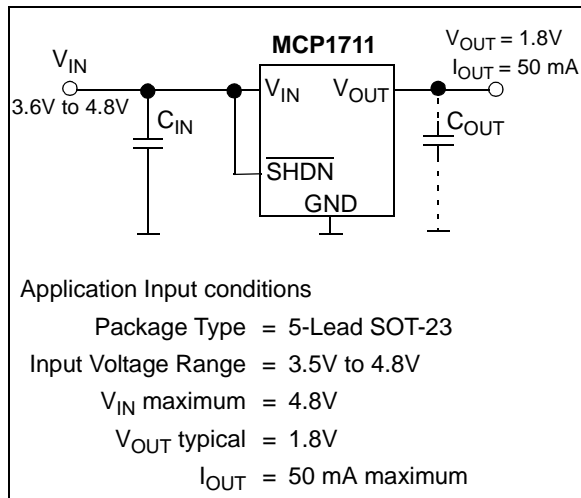

FIGURE 5-1: Typical Application Circuit.

5.2 Power Calculations

5.2.1 POWER DISSIPATION

The internal power dissipation of the MCP1711 is a function of input voltage, output voltage and output current. The power dissipation, as a result of the quiescent current draw, is so low that it is insignificant ($0.6 \mu\text{A} \times V_{IN}$). To calculate the internal power dissipation of the LDO use [Equation 5-1](#):

EQUATION 5-1:

$$P_{LDO} = (V_{IN(MAX)} - V_{OUT(MIN)}) \times I_{OUT(MAX)}$$

Where:

P_{LDO} = LDO pass device internal power dissipation

$V_{IN(MAX)}$ = Maximum input voltage

$V_{OUT(MIN)}$ = LDO minimum output voltage, including the line and load regulations

The maximum continuous operating junction temperature specified for the MCP1711 is +125°C. To estimate the internal junction temperature of the MCP1711, the total internal power dissipation is multiplied by the thermal resistance from junction-to-ambient ($R\theta_{JA}$).

The thermal resistance from junction-to-ambient for the 5-Lead SOT-23 package is estimated at:

- 166.67°C with JEDEC 51-7 FR-4 board with thermal vias and
- 400 °C/W when the device is not mounted on the PCB, or is mounted on the one layer PCB with minimal copper that doesn't provide any additional cooling.

EQUATION 5-2:

$$T_{J(MAX)} = P_{TOTAL} \times R\theta_{JA} + T_{A(MAX)}$$

Where:

$T_{J(MAX)}$ = Maximum continuous junction temperature

P_{TOTAL} = Total device power dissipation

$R\theta_{JA}$ = Thermal resistance from junction to ambient

$T_{A(MAX)}$ = Maximum ambient temperature

The maximum power dissipation capability for a package can be calculated if given the junction-to-ambient thermal resistance ($R\theta_{JA}$) and the maximum ambient temperature for the application. [Equations 5-3 to 5-5](#) can be used to determine the package maximum internal power dissipation:

EQUATION 5-3:

$$P_{D(MAX)} = \frac{(T_{J(MAX)} - T_{A(MAX)})}{R\theta_{JA}}$$

Where:

$P_{D(MAX)}$ = Maximum device power dissipation

$T_{J(MAX)}$ = Maximum continuous junction temperature

$T_{A(MAX)}$ = Maximum ambient temperature

$R\theta_{JA}$ = Thermal resistance from junction to ambient

EQUATION 5-4:

$$T_{J(RISE)} = P_{D(MAX)} \times R\theta_{JA}$$

Where:

$T_{J(RISE)}$ = Rise in device junction temperature over the ambient temperature

$P_{D(MAX)}$ = Maximum device power dissipation

$R\theta_{JA}$ = Thermal resistance from junction to ambient

EQUATION 5-5:

$$T_J = T_{J(RISE)} + T_A$$

Where:

 T_J = Junction temperature $T_{J(RISE)}$ = Rise in device junction temperature over the ambient temperature T_A = Ambient temperature**5.3 Voltage Regulator**

Internal power dissipation, junction temperature rise, junction temperature and maximum power dissipation are calculated in the following example. The power dissipation, as a result of ground current, is small enough to be neglected.

5.3.1 POWER DISSIPATION EXAMPLE**EXAMPLE 5-1: POWER DISSIPATION****Package**

Package Type = SOT-23

Input Voltage $V_{IN} = 3.5V$ to $4.8V$ **LDO Output Voltages and Currents** $V_{OUT} = 1.8V$ $I_{OUT} = 50$ mA**Maximum Ambient Temperature** $T_{A(MAX)} = +40^\circ C$ **Internal Power Dissipation**

Internal Power dissipation is the product of the LDO output current times the voltage across the LDO (V_{IN} to V_{OUT}).

$$P_{LDO(MAX)} = (V_{IN(MAX)} - V_{OUT(MIN)}) \times I_{OUT(MAX)}$$

$V_{OUT(MIN)} = 1.78V - 0.05V = 1.73V$, where 1.78V is the minimum output voltage due to accuracy, and 0.05V is the load regulation; due to very small input voltage range, the line regulation is neglected

$$P_{LDO} = (4.8V - 1.73V) \times 50$$
 mA

$$P_{LDO} = 153.5$$
 mW

5.3.1.1 Device Junction Temperature Rise

The internal junction temperature rise is a function of internal power dissipation and the thermal resistance from junction to ambient for the application. The thermal resistance from junction to ambient ($R_{\theta JA}$) is derived from an EIA/JEDEC standard for measuring thermal resistance for small surface mount packages.

The EIA/JEDEC specification is JESD51-7, *High Effective Thermal Conductivity Test Board for Leaded Surface Mount Packages*. The standard describes the test method and board specifications for measuring the thermal resistance from junction to ambient. The actual thermal resistance for a particular application can vary depending on many factors, such as copper area and thickness. Refer to AN792 – *A Method to Determine How Much Power a SOT-23 Can Dissipate in an Application* (DS00792), for more information regarding this subject.

EXAMPLE 5-2:

$$T_{J(RISE)} = P_{TOTAL} \times R_{\theta JA}$$

$$T_{JRISE} = 153.5$$
 mW \times $400.0^\circ C/W$

$$T_{JRISE} = 61.4^\circ C$$

5.3.1.2 Junction Temperature Estimate

To estimate the internal junction temperature, the calculated temperature rise is added to the ambient or offset temperature. For this example, the worst-case junction temperature is estimated:

EXAMPLE 5-3:

$$T_J = T_{JRISE} + T_{A(MAX)}$$

$$T_J = 61.4^\circ C + 40^\circ C = 101.4^\circ C$$

5.3.1.3 Maximum Package Power Dissipation Example at +40°C Ambient Temperature**EXAMPLE 5-4:**

$$SOT-23 (400.0^\circ C/W = R_{\theta JA})$$

$$P_{D(MAX)} = (125^\circ C - 40^\circ C)/400^\circ C/W$$

$$P_{D(MAX)} = 212$$
 mW

MCP1711

5.4 Voltage Reference

The MCP1711 can be used not only as a regulator, but also as a low quiescent current voltage reference. In many microcontroller applications, the initial accuracy of the reference can be calibrated using production test equipment or by using a ratio measurement. When the initial accuracy is calibrated, the thermal stability and line regulation tolerance are the only errors introduced by the MCP1711 LDO. The low cost, low quiescent current and small ceramic output capacitor are all advantages when using the MCP1711 as a voltage reference.

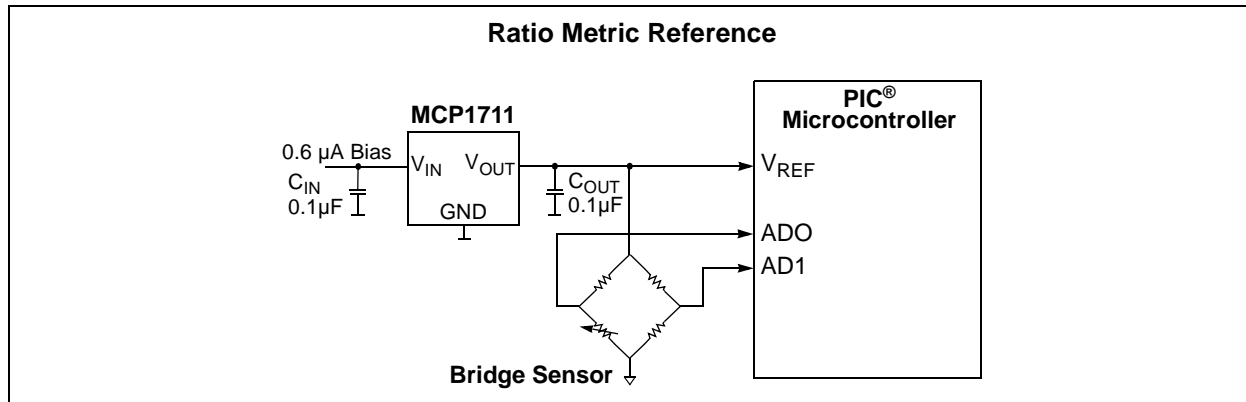

FIGURE 5-2: Using the MCP1711 as a Voltage Reference.

5.5 Pulsed Load Applications

For some applications, there are pulsed load current events that may exceed the specified 150 mA maximum specification of the MCP1711. The internal current limit of the MCP1711 will prevent high peak-load demands from causing nonrecoverable damage. The 150 mA rating is a maximum average continuous rating. As long as the average current does not exceed 150 mA, higher pulsed load currents can be applied to the MCP1711. The typical current limit for the MCP1711 is 270 mA ($T_A = +25^\circ\text{C}$).

6.0 PACKAGING INFORMATION**6.1 Package Marking Information**

4-Lead UQFN (1x1x0.6 mm)

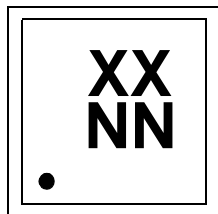

| Device | Code |
|-----------------|------|
| MCP1711T-12I/5X | P2NN |
| MCP1711T-18I/5X | P8NN |
| MCP1711T-20I/5X | PANN |
| MCP1711T-22I/5X | PCNN |
| MCP1711T-25I/5X | PFNN |
| MCP1711T-30I/5X | PNNN |
| MCP1711T-33I/5X | PSNN |

Example

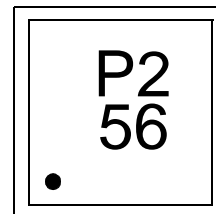

5-Lead SOT-23

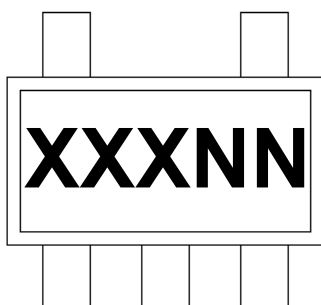

| Device | Code |
|-----------------|-------|
| MCP1711T-12I/OT | 9A2xx |
| MCP1711T-18I/OT | 9A8xx |
| MCP1711T-19I/OT | 9A9xx |
| MCP1711T-22I/OT | 9ACxx |
| MCP1711T-25I/OT | 9AFxx |
| MCP1711T-30I/OT | 9ANxx |
| MCP1711T-33I/OT | 9ASxx |
| MCP1711T-50I/OT | 9BAxx |

Example

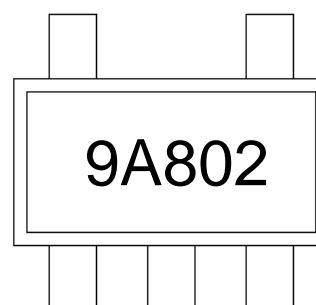

| | | |
|----------------|--------|--|
| Legend: | XX...X | Customer-specific information |
| | Y | Year code (last digit of calendar year) |
| | YY | Year code (last 2 digits of calendar year) |
| | WW | Week code (week of January 1 is week '01') |
| | NNN | Alphanumeric traceability code |
| | (e3) | Pb-free JEDEC designator for Matte Tin (Sn) |
| | * (e3) | This package is Pb-free. The Pb-free JEDEC designator (e3) can be found on the outer packaging for this package. |

Note: In the event the full Microchip part number cannot be marked on one line, it will be carried over to the next line, thus limiting the number of available characters for customer-specific information.

MCP1711

4-Lead Plastic Ultra Thin Quad Flatpack No-Leads (5X) - 1x1x0.6mm [UQFN] (Formerly USPQ-4B04)

Note: For the most current package drawings, please see the Microchip Packaging Specification located at <http://www.microchip.com/packaging>

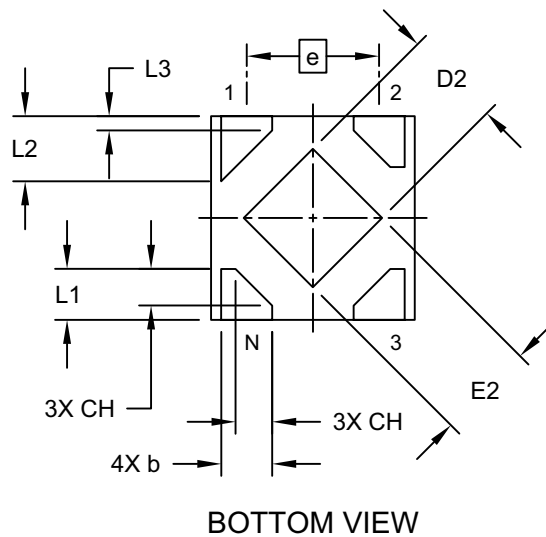
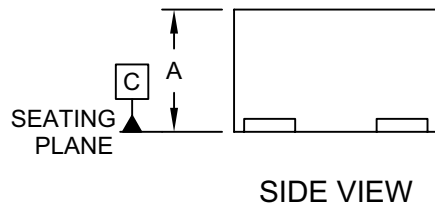
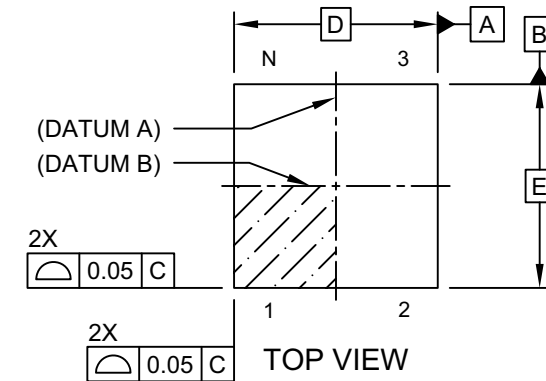

Microchip Technology Drawing C04-393B Sheet 1 of 2

**4-Lead Plastic Ultra Thin Quad Flatpack No-Leads (5X) - 1x1x0.6mm [UQFN]
(Formerly USPQ-4B04)**

Note: For the most current package drawings, please see the Microchip Packaging Specification located at <http://www.microchip.com/packaging>

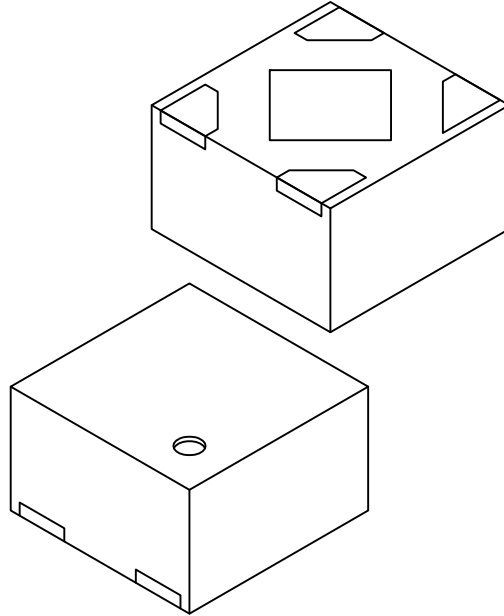

| | | MILLIMETERS | | |
|---------------------|----|-------------|------|------|
| Units | | | | |
| Dimension Limits | | MIN | NOM | MAX |
| Number of Terminals | N | 4 | | |
| Pitch | e | 0.65 BSC | | |
| Overall Height | A | - | - | 0.60 |
| Overall Width | E | 1.00 BSC | | |
| Exposed Pad Width | E2 | 0.43 | 0.48 | 0.53 |
| Overall Length | D | 1.00 BSC | | |
| Exposed Pad Length | D2 | 0.43 | 0.48 | 0.53 |
| Terminal Width | b | 0.20 | 0.25 | 0.30 |
| Terminal Length | L1 | 0.20 | 0.25 | 0.30 |
| Terminal Length | L2 | 0.27 | 0.32 | 0.37 |
| - | L3 | 0.02 | 0.07 | 0.12 |
| Terminal Chamfer | CH | - | 0.18 | - |

Notes:

- Pin 1 visual index feature may vary, but must be located within the hatched area.
- Package is saw singulated
- Dimensioning and tolerancing per ASME Y14.5M

BSC: Basic Dimension. Theoretically exact value shown without tolerances.

REF: Reference Dimension, usually without tolerance, for information purposes only.

Microchip Technology Drawing C04-393B Sheet 2 of 2

MCP1711

4-Lead Plastic Ultra Thin Quad Flatpack No-Leads (5X) - 1x1x0.6mm [UQFN] (Formerly USPQ-4B04)

Note: For the most current package drawings, please see the Microchip Packaging Specification located at <http://www.microchip.com/packaging>

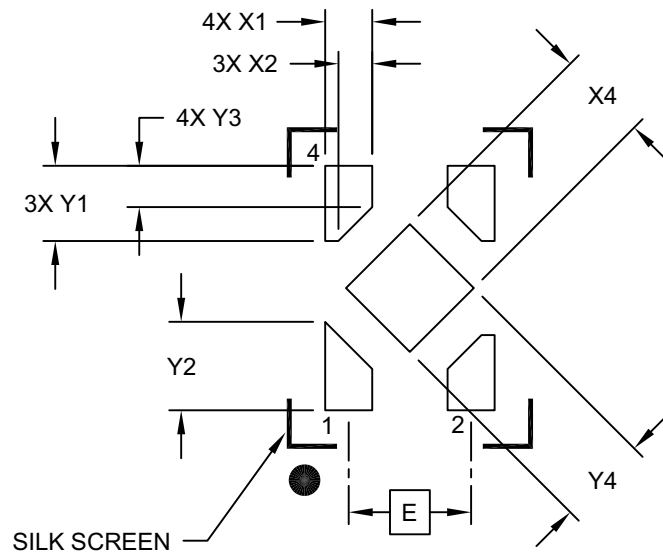

RECOMMENDED LAND PATTERN

| Units | MILLIMETERS | | |
|------------------|-------------|----------|-----|
| | MIN | NOM | MAX |
| Dimension Limits | | | |
| E | | 0.65 BSC | |
| X1 | | 0.25 | |
| X2 | | 0.18 | |
| X4 | | 0.48 | |
| Y1 | | 0.40 | |
| Y2 | | 0.47 | |
| Y3 | | 0.22 | |
| Y4 | | 0.48 | |

Notes:

1. Dimensioning and tolerancing per ASME Y14.5M
BSC: Basic Dimension. Theoretically exact value shown without tolerances.

Microchip Technology Drawing C04-2393B

5-Lead Plastic Small Outline Transistor (OT) [SOT-23]

Note: For the most current package drawings, please see the Microchip Packaging Specification located at <http://www.microchip.com/packaging>

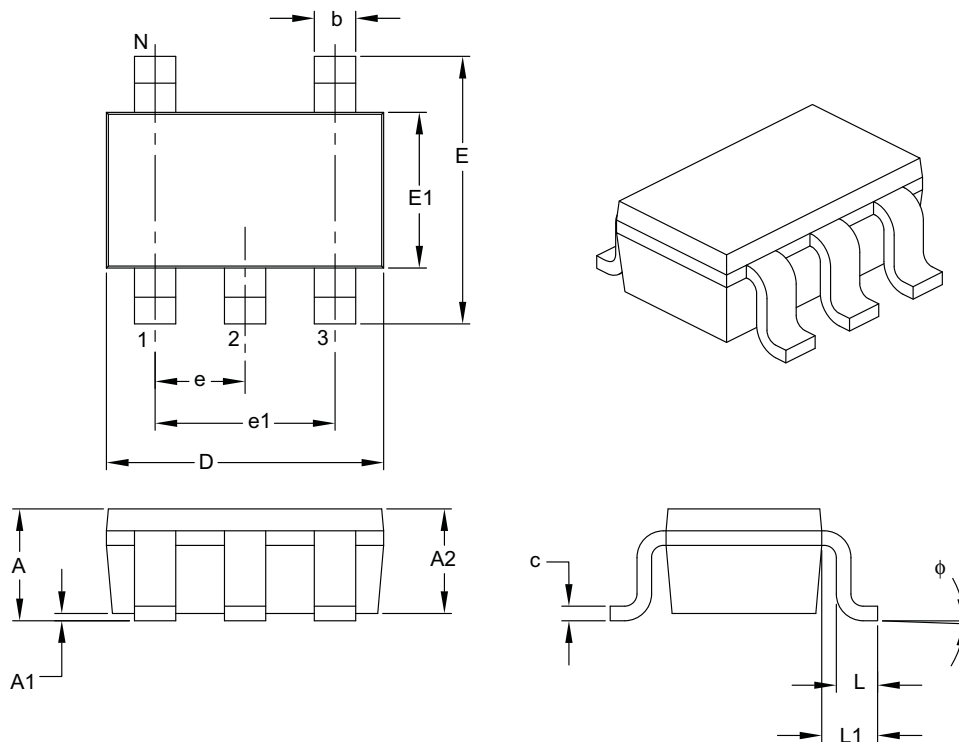

| Dimension Limits | Units | MILLIMETERS | | |
|--------------------------|--------|-------------|-----|------|
| | | MIN | NOM | MAX |
| Number of Pins | N | 5 | | |
| Lead Pitch | e | 0.95 BSC | | |
| Outside Lead Pitch | e1 | 1.90 BSC | | |
| Overall Height | A | 0.90 | – | 1.45 |
| Molded Package Thickness | A2 | 0.89 | – | 1.30 |
| Standoff | A1 | 0.00 | – | 0.15 |
| Overall Width | E | 2.20 | – | 3.20 |
| Molded Package Width | E1 | 1.30 | – | 1.80 |
| Overall Length | D | 2.70 | – | 3.10 |
| Foot Length | L | 0.10 | – | 0.60 |
| Footprint | L1 | 0.35 | – | 0.80 |
| Foot Angle | ϕ | 0° | – | 30° |
| Lead Thickness | c | 0.08 | – | 0.26 |
| Lead Width | b | 0.20 | – | 0.51 |

Notes:

- Dimensions D and E1 do not include mold flash or protrusions. Mold flash or protrusions shall not exceed 0.127 mm per side.
- Dimensioning and tolerancing per ASME Y14.5M.

BSC: Basic Dimension. Theoretically exact value shown without tolerances.

Microchip Technology Drawing C04-091B

MCP1711

5-Lead Plastic Small Outline Transistor (OT) [SOT-23]

Note: For the most current package drawings, please see the Microchip Packaging Specification located at <http://www.microchip.com/packaging>

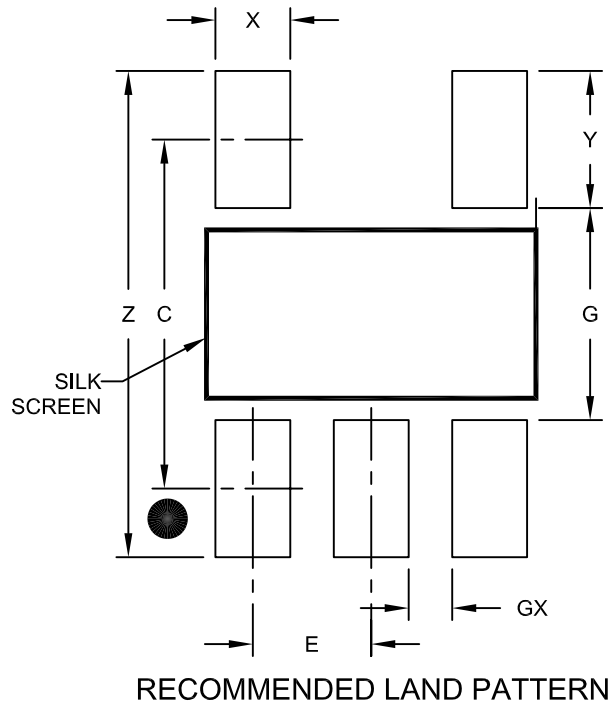

| Dimension Limits | Units | MILLIMETERS | | |
|-------------------------|-------|-------------|------|------|
| | | MIN | NOM | MAX |
| Contact Pitch | E | 0.95 BSC | | |
| Contact Pad Spacing | C | | 2.80 | |
| Contact Pad Width (X5) | X | | | 0.60 |
| Contact Pad Length (X5) | Y | | | 1.10 |
| Distance Between Pads | G | 1.70 | | |
| Distance Between Pads | GX | 0.35 | | |
| Overall Width | Z | | | 3.90 |

Notes:

1. Dimensioning and tolerancing per ASME Y14.5M

BSC: Basic Dimension. Theoretically exact value shown without tolerances.

Microchip Technology Drawing No. C04-2091A

APPENDIX A: REVISION HISTORY

Revision D (October 2016)

The following is the list of modifications:

- Added the 2.0V output voltage option (for the UQFN package) and related information throughout the document
- Minor typographical corrections.

Revision C (March 2016)

- Minor typographical corrections.

Revision B (October 2015)

The following is the list of modifications:

- Updated thermal resistances in [Section 1.0, Electrical Characteristics](#).
- Updated [Section 2.0, Typical Performance Curves](#) with new load step screen-shots.

Revision A (June 2015)

- Original release of this document.

MCP1711

NOTES:

PRODUCT IDENTIFICATION SYSTEM

To order or obtain information, e.g., on pricing or delivery, contact your local Microchip representative or sales office.

| <u>PART NO.</u> | <u>[X1]⁽¹⁾</u> | <u>-X</u> | <u>X</u> | <u>/XX</u> | Examples: | | | | | | | | | | | | | | | | | | | | | | | | | | | | | | | | | | | | | | | | | | | | | | | | | | | | | | | | | | | | | | | | | |
|---|-----------------------------|---|--|----------------|---|----------|---|--|--|------------------------|----|---|------|--|--|----|---|------|--|--|----|---|------|--|--|----|---|------|--|--|----|---|------|--|--|----|---|------|--|--|----|---|------|--|--|----|---|------|--|--|----|---|------|--|---------------------------|---|---|-----------------------------|--|------------------|----|---|---|--|--|----|---|--|--|---|
| Device | Tape and Reel Option | Output Voltage | Temperature Range | Package | | | | | | | | | | | | | | | | | | | | | | | | | | | | | | | | | | | | | | | | | | | | | | | | | | | | | | | | | | | | | | | | | | |
| <table border="1"> <tr> <td>Device:</td> <td>MCP1711:</td> <td colspan="3">150 mA Ultra-Low Quiescent Current, Capacitorless LDO Regulator</td> </tr> <tr> <td>Output Voltage:</td> <td>12</td> <td>=</td> <td>1.2V</td> <td></td> </tr> <tr> <td></td> <td>18</td> <td>=</td> <td>1.8V</td> <td></td> </tr> <tr> <td></td> <td>19</td> <td>=</td> <td>1.9V</td> <td></td> </tr> <tr> <td></td> <td>20</td> <td>=</td> <td>2.0V</td> <td></td> </tr> <tr> <td></td> <td>22</td> <td>=</td> <td>2.2V</td> <td></td> </tr> <tr> <td></td> <td>25</td> <td>=</td> <td>2.5V</td> <td></td> </tr> <tr> <td></td> <td>30</td> <td>=</td> <td>3.0V</td> <td></td> </tr> <tr> <td></td> <td>33</td> <td>=</td> <td>3.3V</td> <td></td> </tr> <tr> <td></td> <td>50</td> <td>=</td> <td>5.0V</td> <td></td> </tr> <tr> <td>Temperature Range:</td> <td>I</td> <td>=</td> <td colspan="2">-40°C to +85°C (Industrial)</td> </tr> <tr> <td>Packages:</td> <td>OT</td> <td>=</td> <td colspan="2">Plastic Small Outline Transistor, 5-Lead SOT-23</td> </tr> <tr> <td></td> <td>5X</td> <td>=</td> <td colspan="2">Plastic Ultra Thin Quad Flatpack No-Leads, 4-Lead 1x1 UQFN</td> </tr> </table> | | | | | Device: | MCP1711: | 150 mA Ultra-Low Quiescent Current, Capacitorless LDO Regulator | | | Output Voltage: | 12 | = | 1.2V | | | 18 | = | 1.8V | | | 19 | = | 1.9V | | | 20 | = | 2.0V | | | 22 | = | 2.2V | | | 25 | = | 2.5V | | | 30 | = | 3.0V | | | 33 | = | 3.3V | | | 50 | = | 5.0V | | Temperature Range: | I | = | -40°C to +85°C (Industrial) | | Packages: | OT | = | Plastic Small Outline Transistor, 5-Lead SOT-23 | | | 5X | = | Plastic Ultra Thin Quad Flatpack No-Leads, 4-Lead 1x1 UQFN | | <p>a) MCP1711T-12I/OT: Tape and Reel, 1.2V Output Voltage, Industrial temperature, 5LD SOT-23</p> <p>b) MCP1711T-18I/OT: Tape and Reel, 1.8V Output Voltage, Industrial temperature, 5LD SOT-23</p> <p>c) MCP1711T-19I/OT: Tape and Reel, 1.9V Output Voltage, Industrial temperature, 5LD SOT-23</p> <p>d) MCP1711T-22I/OT: Tape and Reel, 2.2V Output Voltage, Industrial temperature, 5LD SOT-23</p> <p>e) MCP1711T-25I/OT: Tape and Reel, 2.5V Output Voltage, Industrial temperature, 5LD SOT-23</p> <p>f) MCP1711T-30I/OT: Tape and Reel, 3.0V Output Voltage, Industrial temperature, 5LD SOT-23</p> <p>g) MCP1711T-33I/OT: Tape and Reel, 3.3V Output Voltage, Industrial temperature, 5LD SOT-23</p> <p>h) MCP1711T-50I/OT: Tape and Reel, 5.0V Output Voltage, Industrial temperature, 5LD SOT-23</p> <p>a) MCP1711T-12I/5X: Tape and Reel, 1.2V Output Voltage, Industrial temperature, 4LD UQFN</p> <p>b) MCP1711T-18I/5X: Tape and Reel, 1.8V Output Voltage, Industrial temperature, 4LD UQFN</p> <p>c) MCP1711T-20I/5X: Tape and Reel, 2.0V Output Voltage, Industrial temperature, 4LD UQFN</p> <p>d) MCP1711T-22I/5X: Tape and Reel, 2.2V Output Voltage, Industrial temperature, 4LD UQFN</p> <p>e) MCP1711T-25I/5X: Tape and Reel, 2.5V Output Voltage, Industrial temperature, 4LD UQFN</p> <p>f) MCP1711T-30I/5X: Tape and Reel, 3.0V Output Voltage, Industrial temperature, 4LD UQFN</p> |
| Device: | MCP1711: | 150 mA Ultra-Low Quiescent Current, Capacitorless LDO Regulator | | | | | | | | | | | | | | | | | | | | | | | | | | | | | | | | | | | | | | | | | | | | | | | | | | | | | | | | | | | | | | | | | | | | |
| Output Voltage: | 12 | = | 1.2V | | | | | | | | | | | | | | | | | | | | | | | | | | | | | | | | | | | | | | | | | | | | | | | | | | | | | | | | | | | | | | | | | | | |
| | 18 | = | 1.8V | | | | | | | | | | | | | | | | | | | | | | | | | | | | | | | | | | | | | | | | | | | | | | | | | | | | | | | | | | | | | | | | | | | |
| | 19 | = | 1.9V | | | | | | | | | | | | | | | | | | | | | | | | | | | | | | | | | | | | | | | | | | | | | | | | | | | | | | | | | | | | | | | | | | | |
| | 20 | = | 2.0V | | | | | | | | | | | | | | | | | | | | | | | | | | | | | | | | | | | | | | | | | | | | | | | | | | | | | | | | | | | | | | | | | | | |
| | 22 | = | 2.2V | | | | | | | | | | | | | | | | | | | | | | | | | | | | | | | | | | | | | | | | | | | | | | | | | | | | | | | | | | | | | | | | | | | |
| | 25 | = | 2.5V | | | | | | | | | | | | | | | | | | | | | | | | | | | | | | | | | | | | | | | | | | | | | | | | | | | | | | | | | | | | | | | | | | | |
| | 30 | = | 3.0V | | | | | | | | | | | | | | | | | | | | | | | | | | | | | | | | | | | | | | | | | | | | | | | | | | | | | | | | | | | | | | | | | | | |
| | 33 | = | 3.3V | | | | | | | | | | | | | | | | | | | | | | | | | | | | | | | | | | | | | | | | | | | | | | | | | | | | | | | | | | | | | | | | | | | |
| | 50 | = | 5.0V | | | | | | | | | | | | | | | | | | | | | | | | | | | | | | | | | | | | | | | | | | | | | | | | | | | | | | | | | | | | | | | | | | | |
| Temperature Range: | I | = | -40°C to +85°C (Industrial) | | | | | | | | | | | | | | | | | | | | | | | | | | | | | | | | | | | | | | | | | | | | | | | | | | | | | | | | | | | | | | | | | | | |
| Packages: | OT | = | Plastic Small Outline Transistor, 5-Lead SOT-23 | | | | | | | | | | | | | | | | | | | | | | | | | | | | | | | | | | | | | | | | | | | | | | | | | | | | | | | | | | | | | | | | | | | |
| | 5X | = | Plastic Ultra Thin Quad Flatpack No-Leads, 4-Lead 1x1 UQFN | | | | | | | | | | | | | | | | | | | | | | | | | | | | | | | | | | | | | | | | | | | | | | | | | | | | | | | | | | | | | | | | | | | |
| | | | | | <p>Note 1: Tape and Reel identifier only appears in the catalog part number description. This identifier is used for ordering purposes and is not printed on the device package. Check with your Microchip Sales Office for package availability with the Tape and Reel option.</p> | | | | | | | | | | | | | | | | | | | | | | | | | | | | | | | | | | | | | | | | | | | | | | | | | | | | | | | | | | | | | | | | | |

MCP1711

NOTES:

Note the following details of the code protection feature on Microchip devices:

- Microchip products meet the specification contained in their particular Microchip Data Sheet.
- Microchip believes that its family of products is one of the most secure families of its kind on the market today, when used in the intended manner and under normal conditions.
- There are dishonest and possibly illegal methods used to breach the code protection feature. All of these methods, to our knowledge, require using the Microchip products in a manner outside the operating specifications contained in Microchip's Data Sheets. Most likely, the person doing so is engaged in theft of intellectual property.
- Microchip is willing to work with the customer who is concerned about the integrity of their code.
- Neither Microchip nor any other semiconductor manufacturer can guarantee the security of their code. Code protection does not mean that we are guaranteeing the product as “unbreakable.”

Code protection is constantly evolving. We at Microchip are committed to continuously improving the code protection features of our products. Attempts to break Microchip's code protection feature may be a violation of the Digital Millennium Copyright Act. If such acts allow unauthorized access to your software or other copyrighted work, you may have a right to sue for relief under that Act.

Information contained in this publication regarding device applications and the like is provided only for your convenience and may be superseded by updates. It is your responsibility to ensure that your application meets with your specifications. MICROCHIP MAKES NO REPRESENTATIONS OR WARRANTIES OF ANY KIND WHETHER EXPRESS OR IMPLIED, WRITTEN OR ORAL, STATUTORY OR OTHERWISE, RELATED TO THE INFORMATION, INCLUDING BUT NOT LIMITED TO ITS CONDITION, QUALITY, PERFORMANCE, MERCHANTABILITY OR FITNESS FOR PURPOSE. Microchip disclaims all liability arising from this information and its use. Use of Microchip devices in life support and/or safety applications is entirely at the buyer's risk, and the buyer agrees to defend, indemnify and hold harmless Microchip from any and all damages, claims, suits, or expenses resulting from such use. No licenses are conveyed, implicitly or otherwise, under any Microchip intellectual property rights unless otherwise stated.

Microchip received ISO/TS-16949:2009 certification for its worldwide headquarters, design and wafer fabrication facilities in Chandler and Tempe, Arizona; Gresham, Oregon and design centers in California and India. The Company's quality system processes and procedures are for its PIC® MCUs and dsPIC® DSCs, KEELoC® code hopping devices, Serial EEPROMs, microperipherals, nonvolatile memory and analog products. In addition, Microchip's quality system for the design and manufacture of development systems is ISO 9001:2000 certified.

**QUALITY MANAGEMENT SYSTEM
CERTIFIED BY DNV
= ISO/TS 16949 =**

Trademarks

The Microchip name and logo, the Microchip logo, AnyRate, dsPIC, FlashFlex, flexPWR, Heldo, JukeBlox, KeeLoq, KeeLoq logo, Klear, LANCheck, LINK MD, MediaLB, MOST, MOST logo, MPLAB, OptoLyzer, PIC, PICSTART, PIC32 logo, RightTouch, SpyNIC, SST, SST Logo, SuperFlash and UNI/O are registered trademarks of Microchip Technology Incorporated in the U.S.A. and other countries.

ClockWorks, The Embedded Control Solutions Company, ETHERSYNCH, Hyper Speed Control, HyperLight Load, IntelliMOS, mTouch, Precision Edge, and QUIET-WIRE are registered trademarks of Microchip Technology Incorporated in the U.S.A.

Analog-for-the-Digital Age, Any Capacitor, AnyIn, AnyOut, BodyCom, chipKIT, chipKIT logo, CodeGuard, dsPICDEM, dsPICDEM.net, Dynamic Average Matching, DAM, ECAN, EtherGREEN, In-Circuit Serial Programming, ICSP, Inter-Chip Connectivity, JitterBlocker, KlearNet, KlearNet logo, MiWi, motorBench, MPASM, MPF, MPLAB Certified logo, MPLIB, MPLINK, MultiTRAK, NetDetach, Omniscient Code Generation, PICDEM, PICDEM.net, PICkit, PICtail, PureSilicon, RightTouch logo, REAL ICE, Ripple Blocker, Serial Quad I/O, SQL, SuperSwitcher, SuperSwitcher II, Total Endurance, TSHARC, USBCheck, VariSense, ViewSpan, WiperLock, Wireless DNA, and ZENA are trademarks of Microchip Technology Incorporated in the U.S.A. and other countries.

SQTP is a service mark of Microchip Technology Incorporated in the U.S.A.

Silicon Storage Technology is a registered trademark of Microchip Technology Inc. in other countries.

GestIC is a registered trademarks of Microchip Technology Germany II GmbH & Co. KG, a subsidiary of Microchip Technology Inc., in other countries.

All other trademarks mentioned herein are property of their respective companies.

© 2015-2016, Microchip Technology Incorporated, Printed in the U.S.A., All Rights Reserved.

ISBN: 978-1-5224-1009-6



MICROCHIP

Worldwide Sales and Service

AMERICAS

Corporate Office

2355 West Chandler Blvd.
Chandler, AZ 85224-6199
Tel: 480-792-7200
Fax: 480-792-7277
Technical Support:
<http://www.microchip.com/support>

Web Address:

www.microchip.com

Atlanta

Duluth, GA
Tel: 678-957-9614
Fax: 678-957-1455

Austin, TX

Tel: 512-257-3370

Boston

Westborough, MA
Tel: 774-760-0087
Fax: 774-760-0088

Chicago

Itasca, IL
Tel: 630-285-0071
Fax: 630-285-0075

Cleveland

Independence, OH
Tel: 216-447-0464
Fax: 216-447-0643

Dallas

Addison, TX
Tel: 972-818-7423
Fax: 972-818-2924

Detroit

Novi, MI
Tel: 248-848-4000

Houston, TX

Tel: 281-894-5983

Indianapolis

Noblesville, IN
Tel: 317-773-8323
Fax: 317-773-5453

Los Angeles

Mission Viejo, CA
Tel: 949-462-9523
Fax: 949-462-9608

New York, NY

Tel: 631-435-6000

San Jose, CA

Tel: 408-735-9110

Canada - Toronto

Tel: 905-695-1980
Fax: 905-695-2078

ASIA/PACIFIC

Asia Pacific Office

Suites 3707-14, 37th Floor
Tower 6, The Gateway
Harbour City, Kowloon

Hong Kong

Tel: 852-2943-5100
Fax: 852-2401-3431

Australia - Sydney

Tel: 61-2-9868-6733
Fax: 61-2-9868-6755

China - Beijing

Tel: 86-10-8569-7000
Fax: 86-10-8528-2104

China - Chengdu

Tel: 86-28-8665-5511
Fax: 86-28-8665-7889

China - Chongqing

Tel: 86-23-8980-9588
Fax: 86-23-8980-9500

China - Dongguan

Tel: 86-769-8702-9880

China - Guangzhou

Tel: 86-20-8755-8029

China - Hangzhou

Tel: 86-571-8792-8115
Fax: 86-571-8792-8116

China - Hong Kong SAR

Tel: 852-2943-5100
Fax: 852-2401-3431

China - Nanjing

Tel: 86-25-8473-2460
Fax: 86-25-8473-2470

China - Qingdao

Tel: 86-532-8502-7355
Fax: 86-532-8502-7205

China - Shanghai

Tel: 86-21-5407-5533
Fax: 86-21-5407-5066

China - Shenyang

Tel: 86-24-2334-2829
Fax: 86-24-2334-2393

China - Shenzhen

Tel: 86-755-8864-2200
Fax: 86-755-8203-1760

China - Wuhan

Tel: 86-27-5980-5300
Fax: 86-27-5980-5118

China - Xian

Tel: 86-29-8833-7252
Fax: 86-29-8833-7256

ASIA/PACIFIC

China - Xiamen

Tel: 86-592-2388138
Fax: 86-592-2388130

China - Zhuhai

Tel: 86-756-3210040
Fax: 86-756-3210049

India - Bangalore

Tel: 91-80-3090-4444
Fax: 91-80-3090-4123

India - New Delhi

Tel: 91-11-4160-8631
Fax: 91-11-4160-8632

India - Pune

Tel: 91-20-3019-1500

Japan - Osaka

Tel: 81-6-6152-7160
Fax: 81-6-6152-9310

Japan - Tokyo

Tel: 81-3-6880-3770
Fax: 81-3-6880-3771

Korea - Daegu

Tel: 82-53-744-4301
Fax: 82-53-744-4302

Korea - Seoul

Tel: 82-2-554-7200
Fax: 82-2-558-5932 or
82-2-558-5934

Malaysia - Kuala Lumpur

Tel: 60-3-6201-9857
Fax: 60-3-6201-9859

Malaysia - Penang

Tel: 60-4-227-8870
Fax: 60-4-227-4068

Philippines - Manila

Tel: 63-2-634-9065
Fax: 63-2-634-9069

Singapore

Tel: 65-6334-8870
Fax: 65-6334-8850

Taiwan - Hsin Chu

Tel: 886-3-5778-366
Fax: 886-3-5770-955

Taiwan - Kaohsiung

Tel: 886-7-213-7828

Taiwan - Taipei

Tel: 886-2-2508-8600
Fax: 886-2-2508-0102

Thailand - Bangkok

Tel: 66-2-694-1351
Fax: 66-2-694-1350

EUROPE

Austria - Wels

Tel: 43-7242-2244-39
Fax: 43-7242-2244-393

Denmark - Copenhagen

Tel: 45-4450-2828
Fax: 45-4485-2829

France - Paris

Tel: 33-1-69-53-63-20
Fax: 33-1-69-30-90-79

Germany - Dusseldorf

Tel: 49-2129-3766400

Germany - Karlsruhe

Tel: 49-721-625370

Germany - Munich

Tel: 49-89-627-144-0
Fax: 49-89-627-144-44

Italy - Milan

Tel: 39-0331-742611
Fax: 39-0331-466781

Italy - Venice

Tel: 39-049-7625286

Netherlands - Drunen

Tel: 31-416-690399
Fax: 31-416-690340

Poland - Warsaw

Tel: 48-22-3325737

Spain - Madrid

Tel: 34-91-708-08-90
Fax: 34-91-708-08-91

Sweden - Stockholm

Tel: 46-8-5090-4654

UK - Wokingham

Tel: 44-118-921-5800
Fax: 44-118-921-5820

06/23/16

OUR CERTIFICATE

DiGi provide top-quality products and perfect service for customer worldwide through standardization, technological innovation and continuous improvement. DiGi through third-party certification, we stricly control the quality of products and services. Welcome your RFQ to

Email: Info@DiGi-Electronics.com



Tel: +00 852-30501935

RFQ Email: Info@DiGi-Electronics.com

DiGi is a global authorized distributor of electronic components.