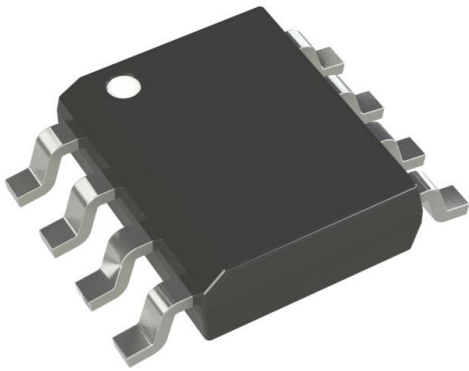


# MCP201T-E/SN Datasheet

[www.digi-electronics.com](http://www.digi-electronics.com)



<https://www.DiGi-Electronics.com>

|                              |                                      |
|------------------------------|--------------------------------------|
| DiGi Electronics Part Number | MCP201T-E/SN-DG                      |
| Manufacturer                 | <a href="#">Microchip Technology</a> |
| Manufacturer Product Number  | MCP201T-E/SN                         |
| Description                  | IC TRANSCEIVER HALF 1/1 8SOIC        |
| Detailed Description         | 1/1 Transceiver Half LINbus 8-SOIC   |



Tel: +00 852-30501935

RFQ Email: [Info@DiGi-Electronics.com](mailto:Info@DiGi-Electronics.com)

DiGi is a global authorized distributor of electronic components.

## Purchase and inquiry

Manufacturer Product Number:

MCP201T-E/SN

Manufacturer:

Microchip Technology

Packaging:

Tape & Reel (TR)

Type:

Transceiver

Number of Drivers/Receivers:

1/1

Receiver Hysteresis:

50 mV

Voltage - Supply:

6V ~ 18V

Mounting Type:

Surface Mount

Supplier Device Package:

8-SOIC

Manufacturer:

Microchip Technology

Series:

-

Part Status:

Obsolete

Protocol:

LINbus

Duplex:

Half

Data Rate:

-

Operating Temperature:

-40°C ~ 125°C

Package / Case:

8-SOIC (0.154", 3.90mm Width)

Base Product Number:

MCP201

## Environmental & Export classification

RoHS Status:

ROHS3 Compliant

REACH Status:

REACH Unaffected

HTSUS:

8542.39.0060

Moisture Sensitivity Level (MSL):

1 (Unlimited)

ECCN:

EAR99



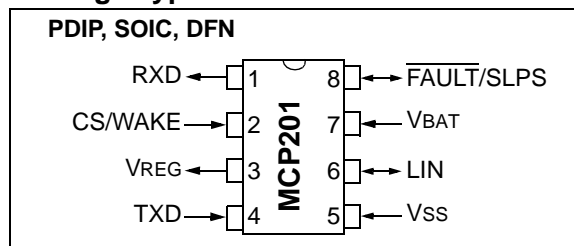
# MCP201

## LIN Transceiver with Voltage Regulator

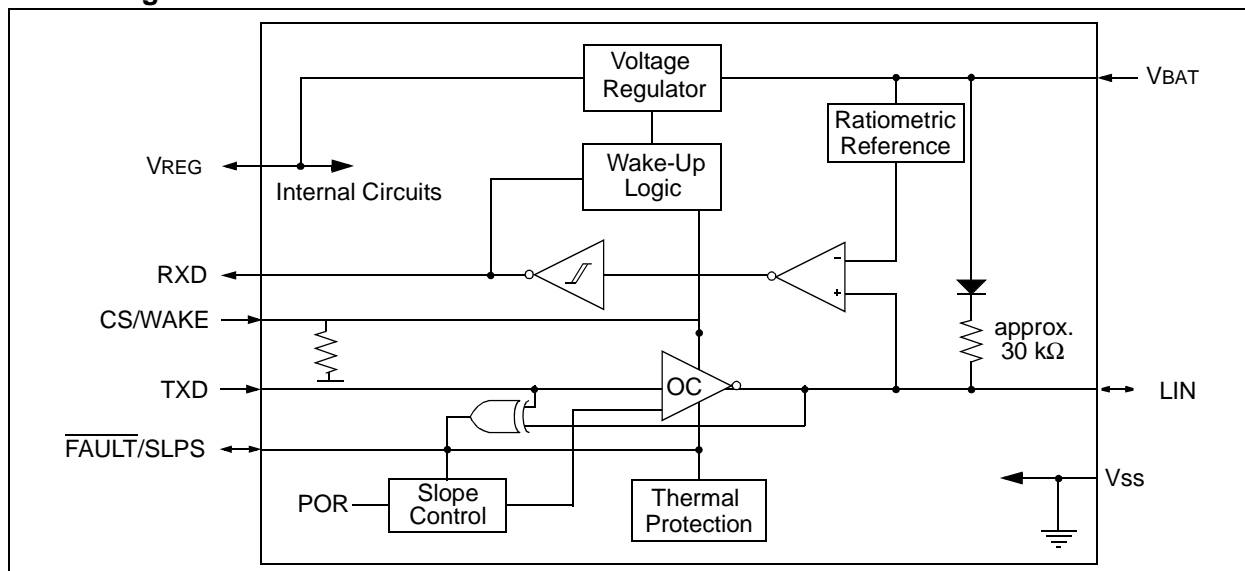
### Features

- Supports baud rates up to 20 Kbaud
- 40V load dump protected
- Wide supply voltage, 6.0 – 18.0V, continuous
  - Maximum input voltage of 30V
- Extended Temperature Range: -40°C to +125°C
- Interface to standard USARTs
- Compatible with LIN Spec 1.3
- Local Interconnect Network (LIN) Line pin:
  - Internal pull-up resistor and diode
  - Protected against ground shorts (LIN pin to ground)
  - Protected against LIN pin loss of ground
  - High current drive,  $40\text{ mA} \leq I_{OL} \leq 200\text{ mA}$
- Automatic thermal shutdown
- On-board Voltage Regulator:
  - Output voltage of 5V with  $\pm 5\%$  tolerances over temperature range
  - Maximum output current of 50 mA
  - Able to drive an external series-pass transistor for increased current supply capability
  - Internal thermal overload protection
  - Internal short-circuit current limit
  - External components limited to filter capacitor only and load capacitor

### Package Types



### Block Diagram



# MCP201

---

NOTES:

## 1.0 DEVICE OVERVIEW

The MCP201 provides a physical interface between a microcontroller and a LIN half-duplex bus. It is intended for automotive and industrial applications with serial bus speeds up to 20 Kbaud.

The MCP201 provides a half-duplex, bidirectional communications interface between a microcontroller and the serial network bus. This device will translate the CMOS/TTL logic levels to LIN level logic, and vice versa.

The LIN specification 1.3 requires that the transceiver of all nodes in the system be connected via the LIN pin, referenced to ground and with a maximum external termination resistance of 510Ω from LIN bus to battery supply. The 510Ω corresponds to 1 Master and 16 Slave nodes.

The MCP201 provides a +5V 50 mA regulated power output. The regulator uses a LDO design, is short-circuit-protected and will turn the regulator output off if it falls below 3.5V. The MCP201 also includes thermal shutdown protection. The regulator has been specifically designed to operate in the automotive environment and will survive reverse battery connections, +40V load dump transients and double-battery jumps (see **Section 1.6 “Internal Voltage Regulator”**).

### 1.1 Optional External Protection

#### 1.1.1 TRANSIENT VOLTAGE PROTECTION (LOAD DUMP)

An external 27V transient suppressor (TVS) diode, between VBAT and ground, with a 50Ω resistor in series with the battery supply and the VBAT pin, serves to protect the device from power transients (see Figure 1-2) and ESD events. While this protection is optional, it should be considered as good engineering practice.

#### 1.1.2 REVERSE BATTERY PROTECTION

An external reverse-battery-blocking diode can be used to provide polarity protection (see Figure 1-2). This protection is optional, but should be considered as good engineering practice.

## 1.2 Internal Protection

### 1.2.1 ESD PROTECTION

For component-level ESD ratings, please refer to the maximum operation specifications.

### 1.2.2 GROUND LOSS PROTECTION

The LIN bus specification states that the LIN pin must transition to the recessive state when ground is disconnected. Therefore, a loss of ground effectively forces the LIN line to a hi-impedance level.

### 1.2.3 THERMAL PROTECTION

The thermal protection circuit monitors the die temperature and is able to shut down the LIN transmitter and voltage regulator. Refer to Table 1-1 for details.

There are three causes for a thermal overload. A thermal shut down can be triggered by any one, or a combination of, the following thermal overload conditions.

- Voltage regulator overload
- LIN bus output overload
- Increase in die temperature due to increase in environment temperature

Driving the TXD and checking the RXD pin makes it possible to determine whether there is a bus contention (Rx = low, Tx = high) or a thermal overload condition (Rx = high, Tx = low).

**Note:** After recovering from a thermal, bus or voltage regulator overload condition, the device will be in the Ready1 mode. In order to go into Operational mode, the CS/WAKE pin has to be toggled.

**TABLE 1-1: SOURCES OF THERMAL OVERLOAD<sup>(1,2)</sup>**

| TXD | RXD | Comments   |
|-----|-----|--|
| L   | H   | LIN transmitter shutdown, receiver and voltage regulator active, thermal overload condition. |
| H   | L   | Regulator shutdown, receiver active, bus contention.   |

**Legend:** x = Don't care, L = Low, H = High

**Note 1:** LIN transceiver overload current on the LIN pin is 200 mA.

**2:** Voltage regulator overload current on voltage regulator greater than 50 mA.

# MCP201

## 1.3 Modes of Operation

For an overview of all operational modes, please refer to Table 1-2.

### 1.3.1 POWER-DOWN MODE

In the Power-down mode, the transmitter and the voltage regulator are both off. Only the receiver section and the CS/WAKE pin wake-up circuits are in operation. This is the lowest power mode.

If any bus activity (e.g., a BREAK character) should occur during Power-down mode, the device will immediately enable the voltage regulator. Once the output has stabilized, the device will enter Ready mode.

The part will enter the Operation mode, if the CS/WAKE pin should become active-high ('1').

### 1.3.2 READY AND READY1 MODES

There are two states for the Ready mode. The only difference between these states is the transition during start-up. The state Ready1 mode ensures that the transition from Ready to Operation mode (once a rising edge of CS/WAKE) occurs without disrupting bus traffic.

Immediately upon entering either Ready1 or Ready mode, the voltage regulator will turn on and provide power. The transmitter portion of the circuit is off, with all other circuits (including the receiver) of the MCP201 being fully operational. The LIN pin is kept in a recessive state.

If a microcontroller is being driven by the voltage regulator output, it will go through a power-on reset and initialization sequence. All other circuits, other than the transmitter, are fully operational. The LIN pin is held in the recessive state.

The device will stay in Ready mode until the CS/WAKE pin transitions high ('1'). After CS/WAKE is active, the transmitter is enabled and the device enters Operation mode.

The device may only enter Power-down mode after going through the Operation mode step.

At power-on of the VBAT supply pin, the component is in either Ready or Ready1 mode, waiting for a CS/WAKE rising edge.

The MCP201 will stay in either mode for 600  $\mu$ s as the regulator powers its internal circuitry and waits until the CS/WAKE pin transitions high. During the 600  $\mu$ s delay, the MCP201 will not recognize a CS/WAKE event. The CS/WAKE transition from low to high should not occur until after this delay.

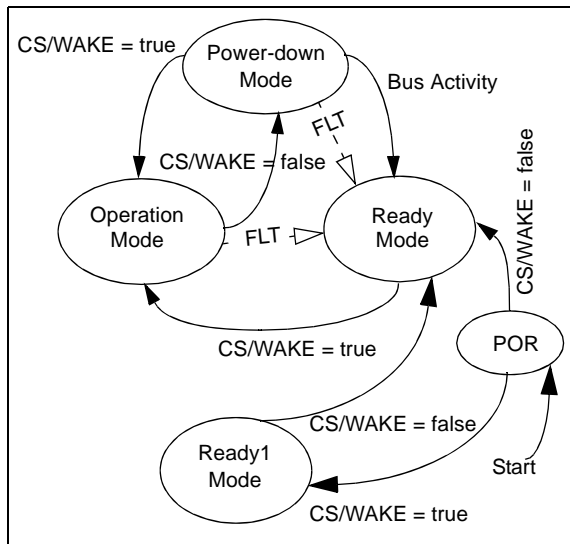
- The CS input is edge, not level, sensitive.
- The CS pin is not monitored until approximately 600  $\mu$ s after VREG has stabilized.
- The transition from Ready1 to Ready is made on the falling edge of CS.
- The transition from Ready mode to Operational mode is on the rising edge of CS.

### 1.3.3 OPERATION MODE

In this mode, all internal modules are operational.

The MCP201 will go into Power-down mode on the falling edge of CS/WAKE.

**FIGURE 1-1: OPERATIONAL MODES STATE DIAGRAMS**



**Note:** After power-on, CS will not be sampled until VREG has stabilized and an additional 600  $\mu$ s has elapsed. The microcontroller should toggle CS approximately 1mS after RESET to ensure that CS will be recognized.

**Note:** While the MCP201 is in shutdown, TXD should not be actively driven high. If TXD is driven high actively, it may power internal logic.

### 1.3.4 DESCRIPTION OF BROWNOUT CONDITIONS

As VBAT decreases VREG is regulated to 5.0 VDC (see VREG in **Section 2.2 "DC Specifications"**) while VBAT is greater than 5.5 - 6.0 VDC.

As VBAT decreases further VREG tracks VBAT (VREG = VBAT - (0.5 to 1.0) VDC).

The MCP201 monitors VREG and as long as VREG does not fall below VSD (see VSD in **Section 2.2 "DC Specifications"**), VREG will remain powered.

As VBAT increases VREG will continue to track VBAT until VREG reaches 5.0 VDC.

If VREG falls below VSD, VREG is turned off and the MCP201 powers itself down.

The MCP201 will remain powered down until VBAT increases above VON (see VON in **Section 2.2 "DC Specifications"**).

**TABLE 1-2: OVERVIEW OF OPERATIONAL MODES**

| State   | Transmitter | Voltage Regulator | Operation   | Comments                           |
|---|-------------|-------------------|---|------------------------------------|
| POR   | OFF         | OFF               | Read CS/WAKE.<br>If low, then READY.<br>If high, READY1 mode.                           | Sample FAULT/SLPS and select slope |
| Ready   | OFF         | ON                | If CS/WAKE rising edge, then Operation mode.  | Bus Off state                      |
| Ready1  | OFF         | ON                | If CS/WAKE falling edge, then READY mode.   | Bus Off state                      |
| Operation   | ON          | ON                | If CS/WAKE falling edge, then Power down.   | Normal Operation mode              |
| Power-down  | OFF         | OFF               | On LIN bus falling, go to READY mode.<br>On CS/WAKE rising edge, go to Operational mode | Low-Power mode                     |
| <b>Note:</b> After power-on, CS will not be sampled until VREG has stabized and an additional 600 $\mu$ s has elapsed. The microcontroller should toggle CS approximately 1mS after RESET to ensure that CS will be recognized. |             |                   |   |                                    |

# MCP201

## 1.4 Typical Applications

FIGURE 1-2: TYPICAL MCP201 APPLICATION<sup>(1,2)</sup>

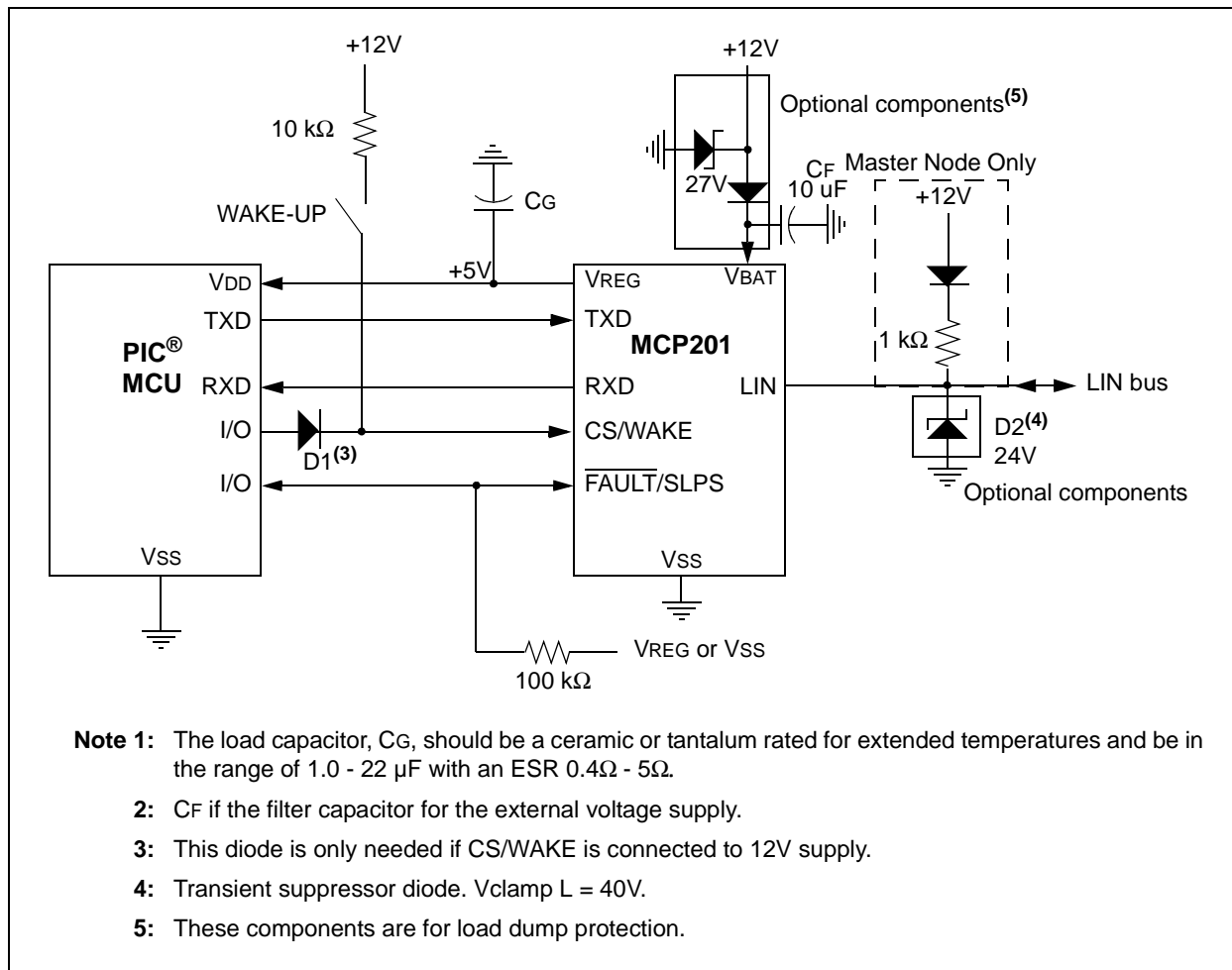
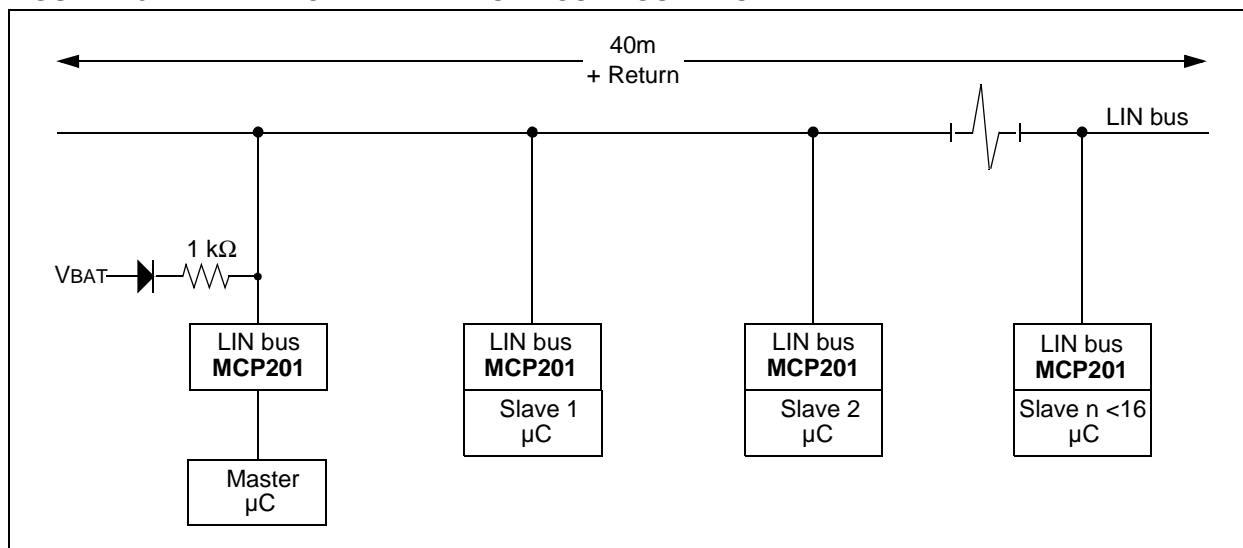


FIGURE 1-3: TYPICAL LIN NETWORK CONFIGURATION





## 1.5 Pin Descriptions

**TABLE 1-3: MCP201 PINOUT OVERVIEW**

| Devices<br>8-Pin PDIP/<br>SOIC/DFN | Bond Pad<br>Name | Function                                |
|------------------------------------|------------------|---|
|                                    |                  | Normal Operation                        |
| 1                                  | RXD              | Receive Data Output (CMOS output)       |
| 2                                  | CS/WAKE          | Chip Select (TTL-HV input)              |
| 3                                  | VREG             | Power Output                            |
| 4                                  | TXD              | Transmit Data Input (TTL)               |
| 5                                  | VSS              | Ground                                  |
| 6                                  | LIN              | LIN bus (bidirectional-HV)              |
| 7                                  | VBAT             | Battery                                 |
| 8                                  | FAULT/SLPS       | Fault Detect Output, Slope Select Input |

**Legend:** TTL = TTL input buffer,  
HV = High Voltage (VBAT)

### 1.5.1 RECEIVE DATA OUTPUT (RXD)

The Receive Data Output pin is a standard CMOS output and follows the state of the LIN pin.

The LIN receiver monitors the state of the LIN pin and generates the output signal RXD.

### 1.5.2 CS/WAKE

Chip Select Input pin. This pin controls whether the part goes into READY1 or READY mode at power-up. The internal pull-down resistor will keep the CS/WAKE pin low. This is done to ensure that no disruptive data will be present on the bus while the microcontroller is executing a Power-on Reset and I/O initialization sequence. The pin must see a low-to-high transition to activate the transmitter.

After CS/WAKE transitions to '1', the transmitter is enabled. If CS/WAKE = '0', the device is in Ready1 mode on power-up or in Low-Power mode. In Low-Power mode, the voltage regulator is shut down, the transmitter driver is disabled and the receiver logic is enabled.

An external switch (see Figure 1-2) can then wake up both the transceiver and the microcontroller. An external-blocking diode and current-limiting resistor are necessary to protect the microcontroller I/O pin.

**Note:** On POR, the MCP201 enters Ready or Ready1 mode (see Figure 1-1). In order to enter Operational mode, the MCP201 has to see one rising edge on CS/WAKE 600  $\mu$ s after the voltage regulator reaches 5V.

### 1.5.3 POWER OUTPUT (VREG)

Positive Supply Voltage Regulator Output pin.

### 1.5.4 TRANSMIT DATA INPUT (TXD)

The Transmit Data Input pin has an internal pull-up to VREG. The LIN pin is low (dominant) when TXD is low, and high (recessive) when TXD is high.

In case the thermal protection detects an over-temperature condition while the signal TXD is low, the transmitter is shutdown. The recovery from the thermal shutdown is equal to adequate cooling time.

### 1.5.5 GROUND (Vss)

Ground pin.

### 1.5.6 LIN

The bidirectional LIN bus Interface pin is the driver unit for the LIN pin and is controlled by the signal TXD. LIN has an open collector output with a current limitation. To reduce EMI, the edges during the signal changes are slope-controlled.

### 1.5.7 BATTERY (VBAT)

Battery Positive Supply Voltage pin. This pin is also the input for the internal voltage regulator.

### 1.5.8 FAULT/SLPS

FAULT Detect Output, Slope Select Input.

This pin is usually in Output mode. Its state is defined as shown in Table 1-5.

The state of this pin is internally sampled during power-on of VBAT. Once VBAT has reached a stable level, (approximately 6 VDC) and VREG is stable at 4.75 to 5.25 VDC, the state of this pin selects which slew rate profile to apply to the LIN output. It is only during this time that the pin is used as an input (the output driver is off during this time). The slope will stay selected until the next VBAT power-off/power-on sequence, regardless of any power-down, wake-up or SLEEP events. Only a VBAT rising state will cause a sampling of the FAULT/SLPS pin. The Slope selection will be made irrespective of the state of any other pin.

The FAULT/SLPS pin is connected to either VREG or Vss through a resistor (approximately 100 k $\Omega$ ) to make the slope selection. This large resistance allows the FAULT indication function to overdrive the resistor in normal operation mode.

If the FAULT/SLPS is high ('1'), the normal slope shaping is selected ( $dv/dt = 2 \text{ V}/\mu\text{s}$ ). If FAULT/SLPS is low ('0') during this time, the alternate slope-shaping is selected ( $dv/dt = 4 \text{ V}/\mu\text{s}$ ). This mode can be used if a user desires to run at a faster slope. This mode is not LIN compliant.

# MCP201

**TABLE 1-4: FAULT / SLPS SLOPE SELECTION DURING POR**

| FAULT/SLPS | Slope Shaping            |
|------------|--------------------------|
| H          | Normal                   |
| L          | Alternate <sup>(1)</sup> |

**Note 1:** This mode does not conform to LIN bus specification version 1.3, but might be used for K-line applications.

**Note:** This pin is '0' whenever the internal circuits have detected a short or thermal excursion and have disabled the LIN output driver.

**Note:** Every time TX is toggled, a Fault condition will occur for the length of time, depending on the bus load. The Fault time is equal to the propagation delay.

**TABLE 1-5: FAULT / SLPS TRUTH TABLE**

| TXD In | RXD Out | LIN Bus I/O | Thermal Override | FAULT / SLPS Out | Comments               |
|--------|---------|-------------|------------------|------------------|------------------------|
| L      | H       | VBAT        | OFF              | L                | Bus shorted to battery |
| H      | H       | VBAT        | OFF              | H                | Bus recessive          |
| L      | L       | GND         | OFF              | H                | Bus dominant           |
| H      | L       | GND         | OFF              | L                | Bus shorted to ground  |
| x      | x       | VBAT        | ON               | L                | Thermal excursion      |

**Legend:** x = don't care

## 1.6 Internal Voltage Regulator

The MCP201 has a low drop-out voltage, positive regulator capable of supplying 5.00 VDC  $\pm 5\%$  at up to 50 mA of load current over the entire operating temperature range. With a load current of 50 mA, the minimum input-to-output voltage differential required for the output to remain in regulation is typically +0.5V (+1V maximum over the full operating temperature range). Quiescent current is less than 1.0 mA, with a full 50 mA load current, when the input-to-output voltage differential is greater than +2V.

The regulator requires an external output bypass capacitor for stability. The capacitor should be either a ceramic or tantalum for stable operation over the extended temperature range. The compensation capacitor should range from 1.0  $\mu\text{f}$  – 22  $\mu\text{f}$  and have a ESR or CSR of 0.4 $\Omega$  – 5.0 $\Omega$ . The input capacitor,  $C_F$ , in Figure 1.4 should be on the order of 8 to 10 times larger than the output capacitor,  $C_G$ .

Designed for automotive applications, the regulator will protect itself from reverse battery connections, double-battery jumps and up to +40V load dump transients. The voltage regulator has both short-circuit and thermal shutdown protection built-in.

Regarding the correlation between VBAT, VREG and IDD, please refer to Figure 1-4 through 1-6. When the input voltage (VBAT) drops below the differential needed to provide stable regulation, the output VREG will track the input down to approximately 3.5V, at which point the regulator will turn off. This will allow microcontrollers with internal POR circuits to generate a clean arming of the Power-on Reset trip point. The MCP201 will then monitor VBAT and turn on the regulator when VBAT is

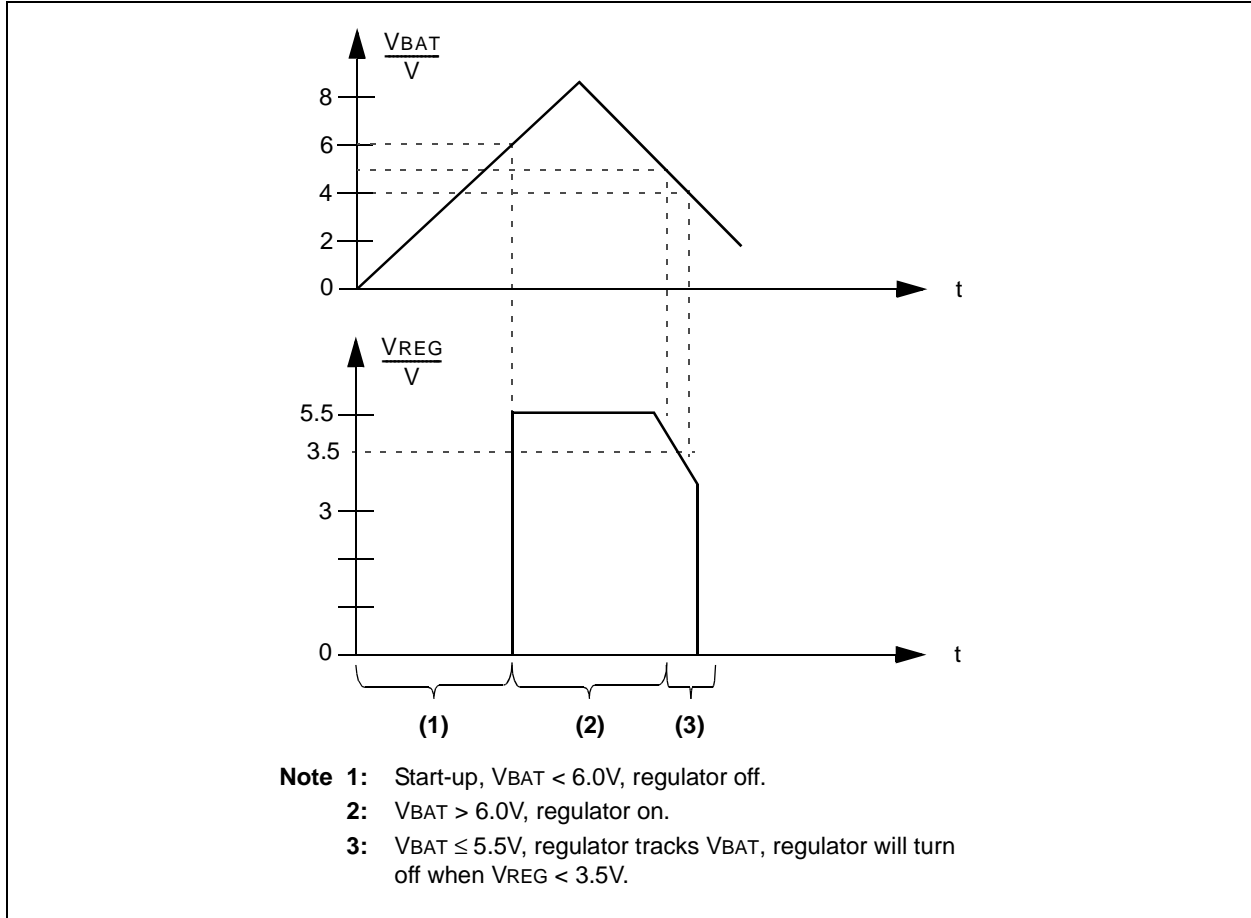
6.0V. The device will come up in either READY1 or READY mode and will have to be transitioned to Operational mode to re-enable data transmission.

In the start phase, VBAT must be at least 6.0V (Figure 1-4) to initiate operation during power-up. In Power-down mode, the VBAT monitor will be turned off.

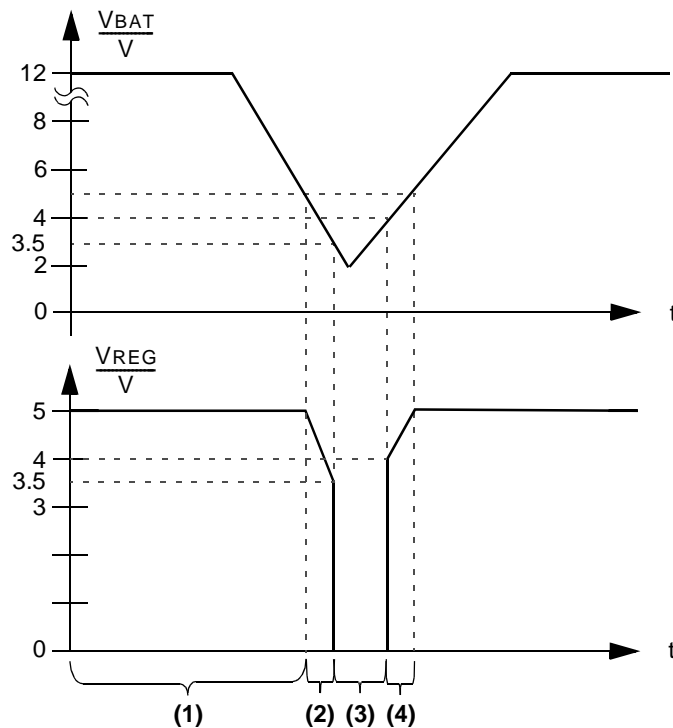
The regulator has a thermal shutdown. If the thermal protection circuit detects an overtemperature condition caused by an overcurrent condition (Figure 1-6) of the regulator, it will shut down.

The regulator has an overload current limiting. During a short-circuit, VREG is monitored. If VREG is lower than 3.5V, the regulator will turn off. After a thermal recovery time, the VREG will be checked again. If there is no short-circuit ( $V_{REG} > 3.5V$ ), the regulator will be switched back on. The MCP201 will come up in either READY1 or READY mode and will have to be transitioned to Operational mode to re-enable data transmission.

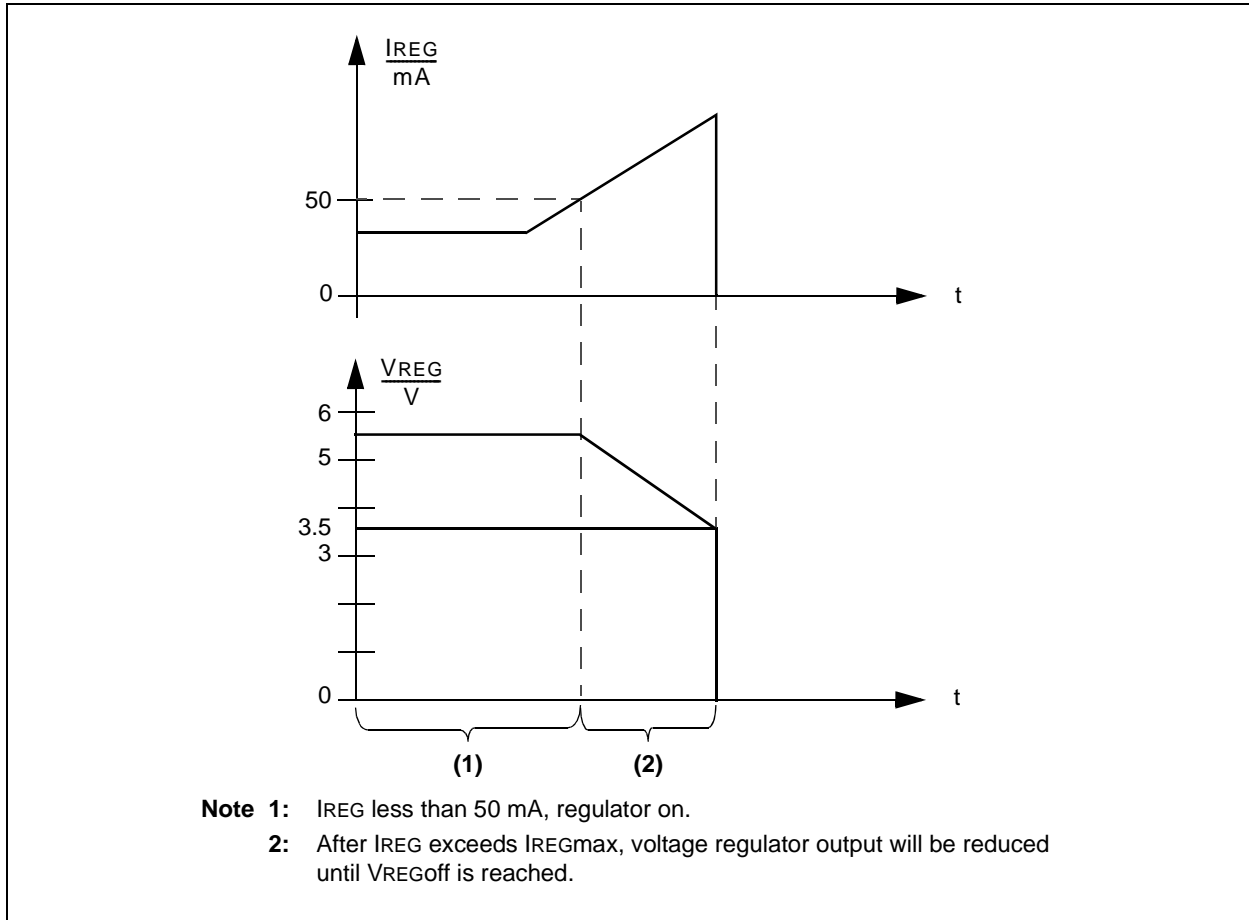
The accuracy of the voltage regulator, when using a pass transistor, will degrade due to the extra external components needed. All performance characteristics should be evaluated on every design.

**FIGURE 1-4: VOLTAGE REGULATOR OUTPUT ON POWER-ON RESET**

# MCP201

**FIGURE 1-5: VOLTAGE REGULATOR OUTPUT ON POWER DIP**


- Note 1:** Voltage regulator on.
- 2:**  $V_{REG} \leq 5.5V$ , regulator tracks  $V_{BAT}$  until  $V_{REG} < 3.5V$ .
- 3:**  $V_{REG} < 3.5V$ , regulator is off. If the voltage regulator should shut off due to  $V_{REG}$  falling below 3.5V, the  $V_{BAT}$  must rise to 6.0V to turn  $V_{REG}$  back on.
- 4:**  $V_{REG} > 4.0V$ , voltage regulator tracks  $V_{DD}$ , when  $V_{REG} > 4.0V$ .

**FIGURE 1-6: VOLTAGE REGULATOR OUTPUT ON OVERCURRENT SITUATION**

## 1.7 ICSP™ Considerations

The following should be considered when the MCP201 is connected to pins supporting in-circuit programming:

- Power used for programming the microcontroller should be supplied from the programmer, not from the MCP201
- The MCP201 should be left unpowered
- The voltage on  $V_{REG}$  should not exceed the maximum output voltage of  $V_{REG}$
- The TXD pin should not be brought high during programming

# MCP201

---

---

NOTES:

**2.0 ELECTRICAL CHARACTERISTICS****2.1 Absolute Maximum Ratings†**

|  |                                |
|--|--------------------------------|
| V <sub>IN</sub> DC Voltage on Logic pins except CS/WAKE .....  | -0.3 to V <sub>REG</sub> +0.3V |
| V <sub>IN</sub> DC Voltage on CS/WAKE .....  | -0.3 to V <sub>BAT</sub> +0.3V |
| V <sub>BAT</sub> Battery Voltage, non-operating (LIN bus recessive, no regulator load, t < 60s)..... | -0.3 to +40V                   |
| V <sub>BAT</sub> Battery Voltage, transient ( <b>Note 1</b> ).....                                   | -0.3 to +40V                   |
| V <sub>BAT</sub> Battery Voltage, continuous .....   | -0.3 to +30V                   |
| V <sub>LBUS</sub> Bus Voltage, continuous.....   | -18 to +30V                    |
| V <sub>LBUS</sub> Bus Voltage, transient ( <b>Note 1</b> ).....                                      | -27 to +40V                    |
| I <sub>LBUS</sub> Bus Short Circuit Current Limit .....  | 200 mA                         |
| ESD protection on LIN, V <sub>BAT</sub> (Human Body Model) ( <b>Note 2</b> ) .....                   | >4 kV                          |
| ESD protection on all other pins (Human Body Model) ( <b>Note 2</b> ) .....                          | >2 kV                          |
| Maximum Junction Temperature .....   | 150°C                          |
| Storage Temperature .....  | -55 to +150°C                  |

**Note 1:** ISO 7637/1 load dump compliant (t < 500 ms).

**2:** According to JESD22-A114-B.

† **NOTICE:** Stresses above those listed under “Maximum Ratings” may cause permanent damage to the device. This is a stress rating only and functional operation of the device at those or any other conditions above those indicated in the operational listings of this specification is not implied. Exposure to maximum rating conditions for extended periods may affect device reliability.

# MCP201

## 2.2 DC Specifications

| DC Specifications                |   | Electrical Characteristics:<br>Unless otherwise indicated, all limits are specified for:<br>VBAT = 6.0V to 18.0V<br>TAMB = -40°C to +125°C<br>CLOADREG = 10 $\mu$ F |      |             |         |  |
|----------------------------------|---|---|------|-------------|---------|--|
| Sym.                             | Parameter   | Min.  | Typ. | Max.        | Units   | Conditions   |
| <b>Power</b>                     |   |   |      |             |         |  |
| IBATQ                            | VBAT Quiescent Operating Current (voltage regulator without load and transceiver) | —   | 0.45 | 1.0         | mA      | IVREG = 0 mA, LIN bus pin recessive, <b>(Note 3)</b>           |
| IBAT                             | VBAT Power-down Current transceiver only  | —   | 23   | 50          | $\mu$ A | CS/WAKE = High, voltage regulator disabled                     |
| IDDQ                             | VREG Quiescent Operating Current  | —   | 500  | —           | $\mu$ A | <b>(Note 2)</b>  |
| IVREG                            | VREG maximum output current   | —   | —    | 50          | mA      | <b>(Note 4)</b>  |
| <b>Microcontroller Interface</b> |   |   |      |             |         |  |
| VIH                              | High-level Input Voltage (TXD, $\overline{\text{FAULT}}/\text{SLPS}$ )            | 2.0   | —    | VREG + 0.3  | V       |  |
| VIL                              | Low-level Input Voltage (TXD, $\overline{\text{FAULT}}/\text{SLPS}$ )             | -0.3  | —    | 0.15 x VREG | V       |  |
| IHTXD                            | High-level Output Current (TXD)   | -90   | —    | +30         | $\mu$ A | Input voltage = 4V   |
| IILTXD                           | Low-level Output Current (TXD)  | -150  | —    | -10         | $\mu$ A | Input voltage = 1V (though > 50 k $\Omega$ internal pull-up)   |
| VIHCS/WAKE                       | High-level Input Voltage (CS/WAKE)  | 3.0   | —    | VBAT        | V       | Through an external current-limiting resistor (10 k $\Omega$ ) |
| VILCS/WAKE                       | Low-level Input Voltage (CS/WAKE)   | -0.3  | —    | 1.0         | V       |  |
| IIHCS/WAKE                       | High-level Input Current (CS/WAKE)  | -10   | —    | +80         | $\mu$ A | Input voltage = 4V (though >100 k $\Omega$ internal pull-down) |
| IILCS/WAKE                       | Low-level Input Current (CS/WAKE)   | 5   | —    | 30          | $\mu$ A | Input voltage = 1V   |
| VOHRXD                           | High-level Output Voltage (RXD)   | 0.8<br>VREG   | —    | —           |         | I <sub>OH</sub> = -4 mA  |
| VOLRXD                           | Low-level Output Voltage (RXD)  | —   | —    | 0.2 VREG    |         | I <sub>OL</sub> = 4 mA   |

**Note 1:** Internal current limited. 2.0 ms typical recovery time (RLBUS = 0 $\Omega$ , TX = 0.4 VREG, VLBUS = VBAT, TAMB = 25C. Recovery time highly dependent on ambient temperature, package and thermal resistance).

**2:** For design guidance only, not tested.

**3:** This current is at the VBAT pin.

**4:** The maximum power dissipation is a function of TJMAX,  $\Theta$ JA and ambient temperature TA. The maximum allowable power dissipation at an ambient temperature is PD = (TJMAX - TA) $\Theta$ JA. If this dissipation is exceeded, the die temperature will rise above 150°C and the MCP201 will go into thermal shutdown.



**2.2 DC Specifications (Continued)**

| DC Specifications        |   | Electrical Characteristics:<br>Unless otherwise indicated, all limits are specified for:<br>VBAT = 6.0V to 18.0V<br>TAMB = -40°C to +125°C<br>CLOADREG = 10 µF |      |          |       |   |
|--------------------------|---|--|------|----------|-------|---|
| Sym.                     | Parameter   | Min.   | Typ. | Max.     | Units | Conditions                                      |
| <b>Bus Interface</b>     |   |  |      |          |       |   |
| VIHLBUS                  | High-level Input Voltage (LBUS)                   | 0.6 VBAT   | —    | 18       | V     | Recessive state                                 |
| VILLBUS                  | Low-level Input Voltage (LBUS)                    | -8   | —    | 0.4 VBAT | V     | Dominant state                                  |
| VHYS                     | Input Hysteresis                                  | 0.05 VBAT  | —    | 0.1 VBAT | V     | VIH - VIL                                       |
| IOL                      | Low-level Output Current (LBUS)                   | 40   | —    | 200      | mA    | Output voltage = 0.1 VBAT, VBAT = 12V           |
| IO                       | High-level Output Current (LBUS)                  | -20  | —    | 20       | µA    | VBUS ≥ VBAT, VLBUS < 40V                        |
| IP                       | Pull-up Current on Input (LBUS)                   | -180   | —    | -60      | µA    | Approx. 30 kΩ internal pull-up @ VIH = 0.7 VBAT |
| ISC                      | Short-circuit Current-Limit                       | 50   | —    | 200      | mA    | <b>(Note 1)</b>                                 |
| VOH                      | High-level Output Voltage (LBUS)                  | 0.8 VBAT   | —    | —        | V     |   |
| VOL                      | Low-level Output Voltage (LBUS)                   | —  | —    | 0.2 VBAT | V     |   |
| <b>Voltage Regulator</b> |   |  |      |          |       |   |
| VREG                     | Output Voltage                                    | 4.75   | —    | 5.25     | V     | 0 mA > IOUT > 50 mA, 7.0V < VBAT < 18V          |
| VREG1                    | Output Voltage                                    | 4.4  | —    | 5.25     | V     | 0 mA > IOUT > 50 mA, 6.0V < VBAT < 7.0V         |
| ΔVREG1                   | Line Regulation                                   | —  | 10   | 50       | mV    | IOUT = 1 mA, 7.0V < VBAT < 18V                  |
| ΔVREG2                   | Load Regulation                                   | —  | 10   | 50       | mV    | 5 mA < IOUT < 50 mA, VBAT = Constant            |
| VN                       | Output Noise Voltage                              | —  | —    | 400      | µVRMS | 1 VRMS @ 10 Hz - 100 kHz                        |
| VSD                      | Shutdown Voltage (monitoring VREG)                | 3.5  | —    | 4.0      | V     | See <b>Figure 1-4</b>                           |
| VON                      | Input Voltage to Turn On Output (monitoring VBAT) | 5.5  | —    | 6.0      | V     |   |

**Note 1:** Internal current limited. 2.0 ms typical recovery time (RLBUS = 0Ω, TX = 0.4 VREG, VLBUS = VBAT, TAMB = 25°C. Recovery time highly dependent on ambient temperature, package and thermal resistance).

**2:** For design guidance only, not tested.

**3:** This current is at the VBAT pin.

**4:** The maximum power dissipation is a function of TJMAX, ΘJA and ambient temperature TA. The maximum allowable power dissipation at an ambient temperature is PD = (TJMAX - TA)ΘJA. If this dissipation is exceeded, the die temperature will rise above 150°C and the MCP201 will go into thermal shutdown.

# MCP201

## 2.3 AC Specifications

| AC Specifications        |   | Electrical Characteristics:   |         |     |       |   |
|--------------------------|---|---|---------|-----|-------|---|
|                          |   | Unless otherwise indicated, all limits are specified for:<br>VBAT = 6.0V to 18.0V<br>TAMB = -40°C to +125°C |         |     |       |   |
| Symbol                   | Parameter   | Min   | Typical | Max | Units | Conditions  |
| <b>Bus Interface</b>     |   |   |         |     |       |   |
| dV/dt                    | Slope Rising and Falling Edges  | 1.0   | 2.0     | 3.0 | V/μs  | (40% to 60%), No Load   |
| dV/dt                    | Slope Rising and Falling edges ALTERNATE  | 2.0   | 4.0     | 6.0 | V/μs  | <b>(Note 1)</b> , No Load   |
| t <sub>TRANSPD</sub>     | Propagation Delay of Transmitter  | —   | —       | 6.0 | μs    | t <sub>RECPD</sub> = max  |
| t <sub>RECPD</sub>       | Propagation Delay of Receiver   | —   | —       | 6.0 | μs    | (t <sub>RECPDR</sub> or t <sub>RECPDF</sub> )                                   |
| t <sub>RECSYM</sub>      | Symmetry of Propagation Delay of Receiver Rising Edge with Respect to Falling Edge    | -2.0  | —       | 2.0 | μs    | t <sub>RECSYM</sub> = max   |
| t <sub>TRANSSYM</sub>    | Symmetry of Propagation Delay of Transmitter Rising Edge with Respect to Falling Edge | -2.0  | —       | 2.0 | μs    | t <sub>TRANSSYM</sub> = max<br>(t <sub>TRANSPDF</sub> - t <sub>TRANSPDR</sub> ) |
| <b>Voltage Regulator</b> |   |   |         |     |       |   |
| t <sub>BACTVE</sub>      | Bus Activity to Voltage Regulator Enabled   | 10  | —       | 40  | μs    | Bus debounce time   |
| t <sub>VEVR</sub>        | Voltage Regulator Enabled to Ready  | —   | 50      | 200 | μs    | <b>(Note 2)</b>   |
| t <sub>VREGPOR</sub>     | Voltage Regulator Enabled to Ready after POR  | —   | —       | 2.5 | ms    | <b>(Note 2)</b> CLOAD = 25 nF   |
| t <sub>CSOR</sub>        | Chip Select to Operation Ready  | 0   | 50      | 200 | μs    | <b>(Note 2)</b>   |
| t <sub>CSPD</sub>        | Chip Select to Power-down   | 0   | —       | 40  | μs    | <b>(Note 2)</b> No CLOAD  |
| t <sub>SHUTDOWN</sub>    | Short-Circuit to Shutdown   | —   | 450     | —   | μs    | Characterized but not tested  |
| t <sub>SCREC</sub>       | Short-Circuit Recovery Time   | —   | 2.0     | —   | ms    | Characterized but not tested <b>(Note 3)</b>                                    |

**Note 1:** The mode does not conform to LIN Bus specification version 1.3.

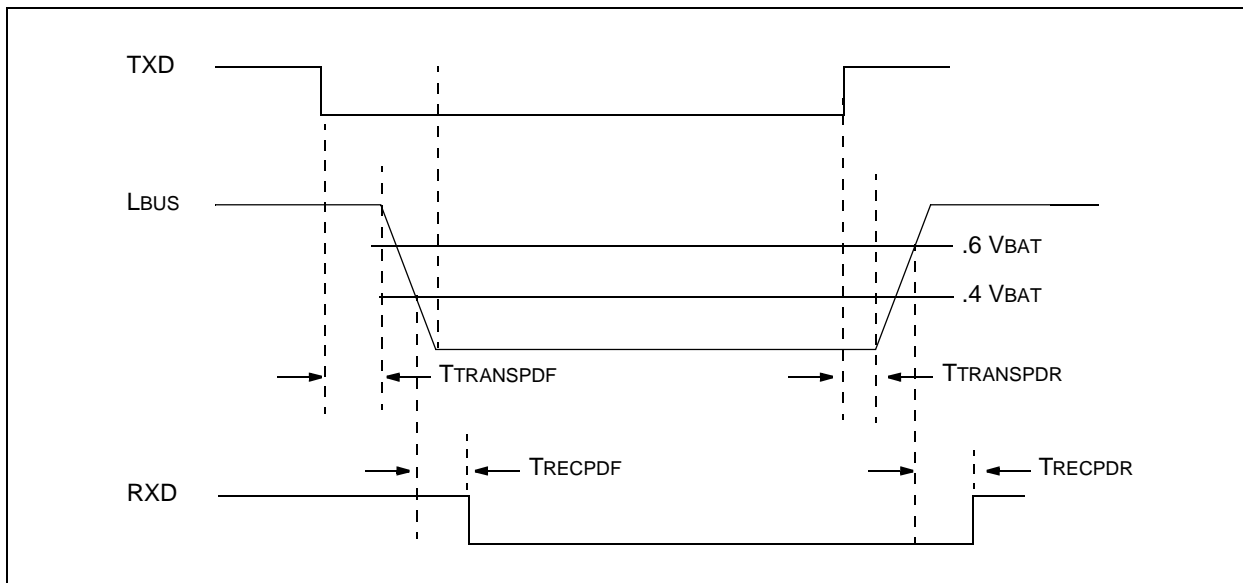
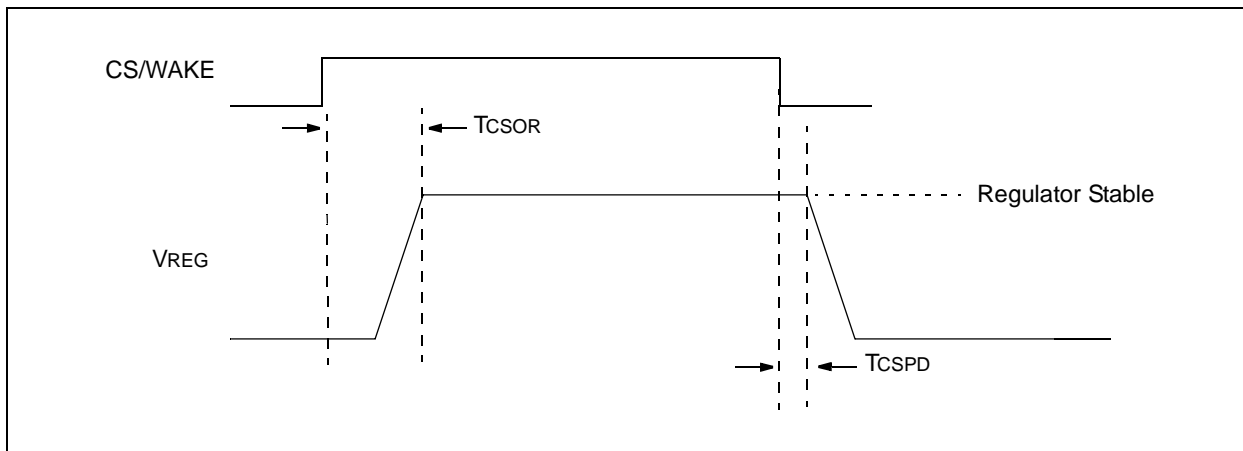
**2:** Time depends on external capacitance and load.

**3:** Internal current limited. 2.0 ms typical recovery time (RLBUS = 0Ω, TX = 0.4 VREG, VLBUS = VBAT, TAMB = 25C. Recovery time highly dependent on ambient temperature, package, and thermal resistance).

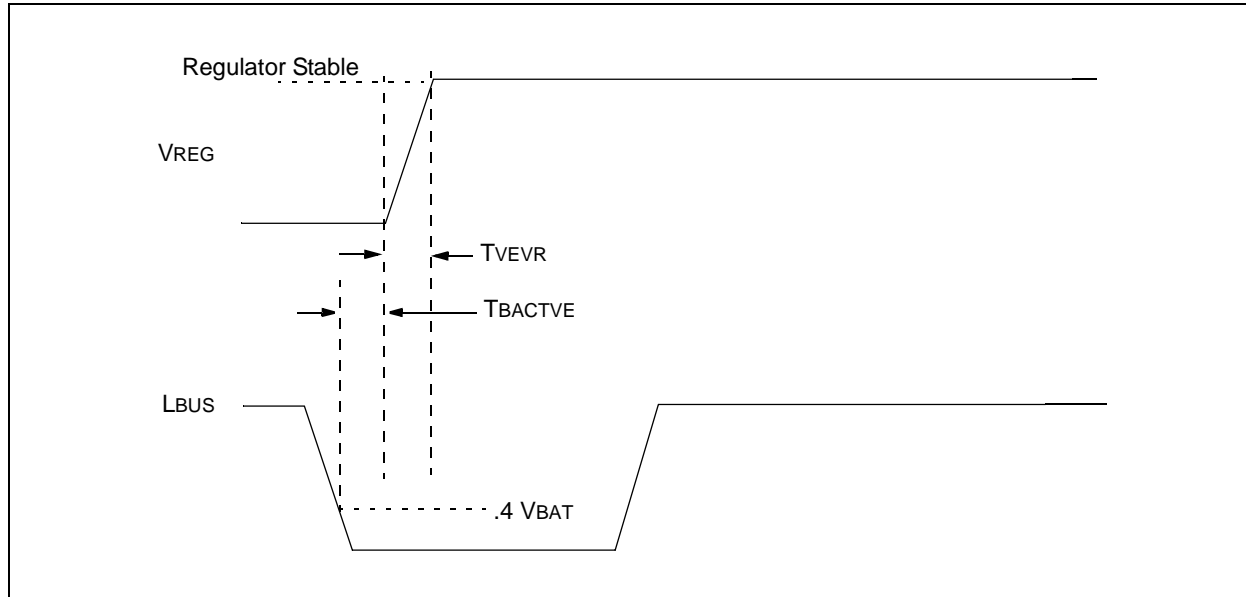
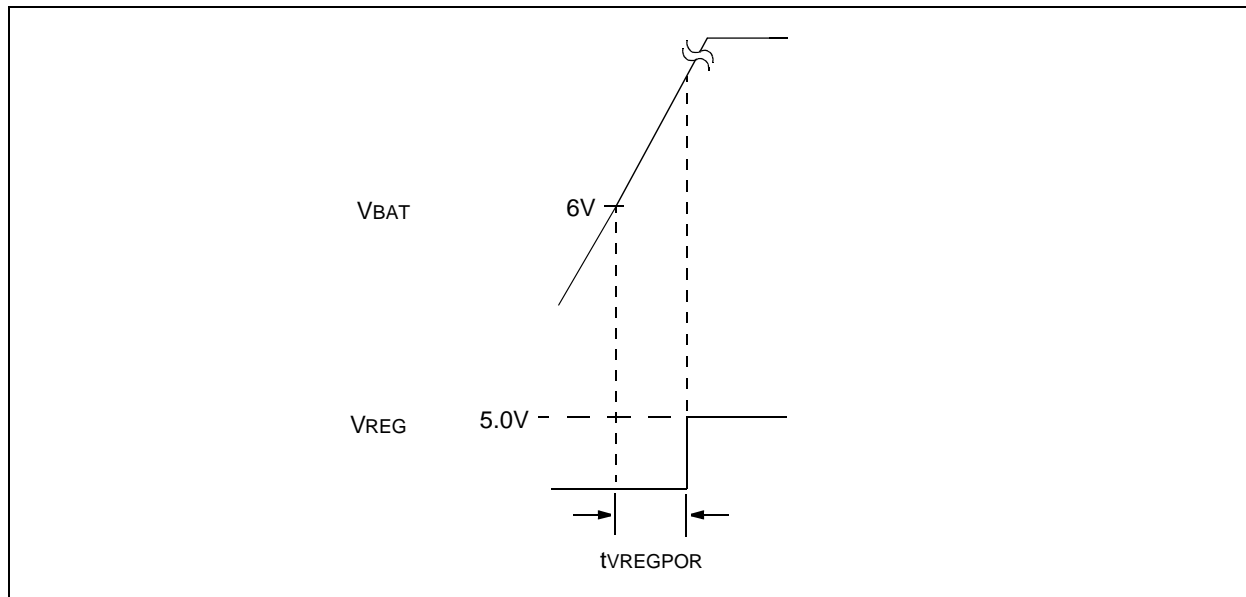
**TABLE 2-1: MCP201 THERMAL SPECIFICATIONS**

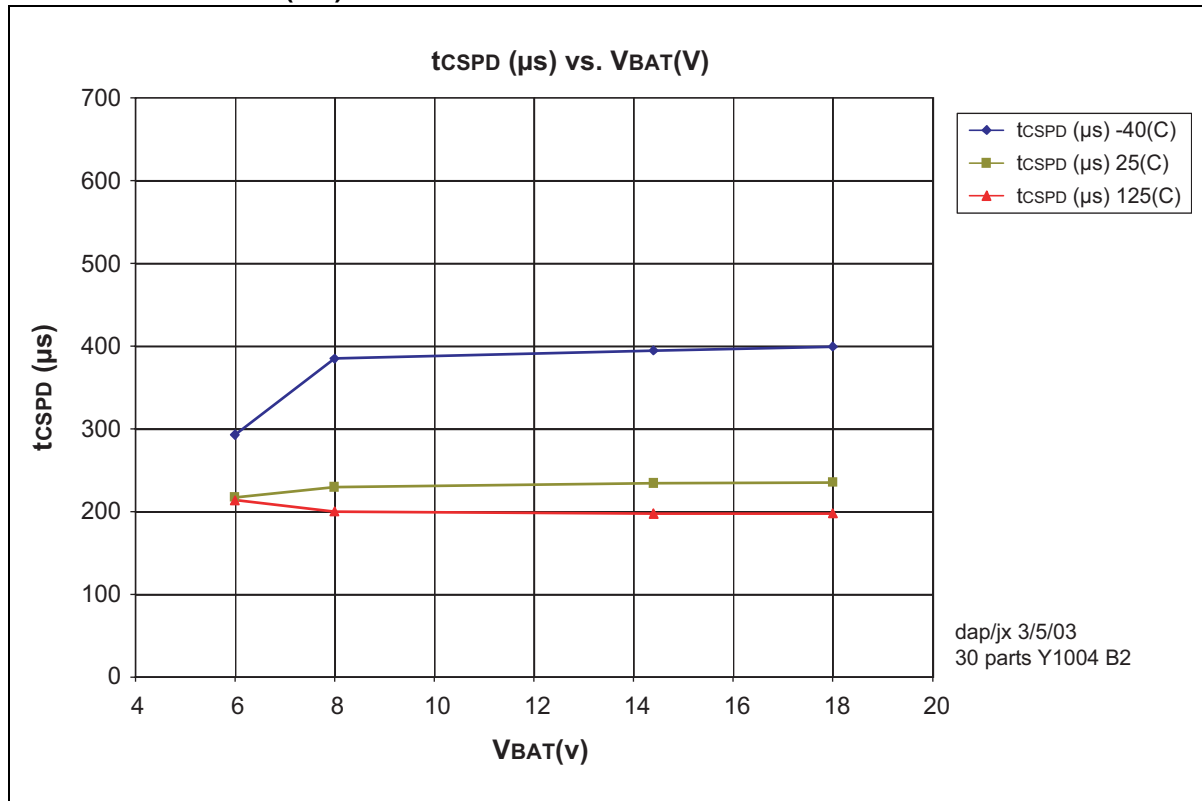
| Sym                   | Parameter   | Min | Typical | Max | Units | Test Conditions                              |
|-----------------------|---|-----|---------|-----|-------|--|
| θ <sub>RECOVERY</sub> | Recovery Temperature (junction temperature)           | —   | +135    | —   | °C    | Characterized but not tested                 |
| θ <sub>SHUTDOWN</sub> | Shutdown Temperature (junction temperature)           | —   | +155    | —   | °C    | Characterized but not tested                 |
| t <sub>THERM</sub>    | Thermal Recovery Time (after Fault condition removed) | —   | 2.0     | —   | ms    | Characterized but not tested <b>(Note 1)</b> |

**Note 1:** Internal current limited. 2.0 ms typical recovery time (RLBUS = 0Ω, TX = 0.4 VREG, VLBUS = VBAT, TAMB = 25C. Recovery time highly dependent on ambient temperature, package, and thermal resistance).

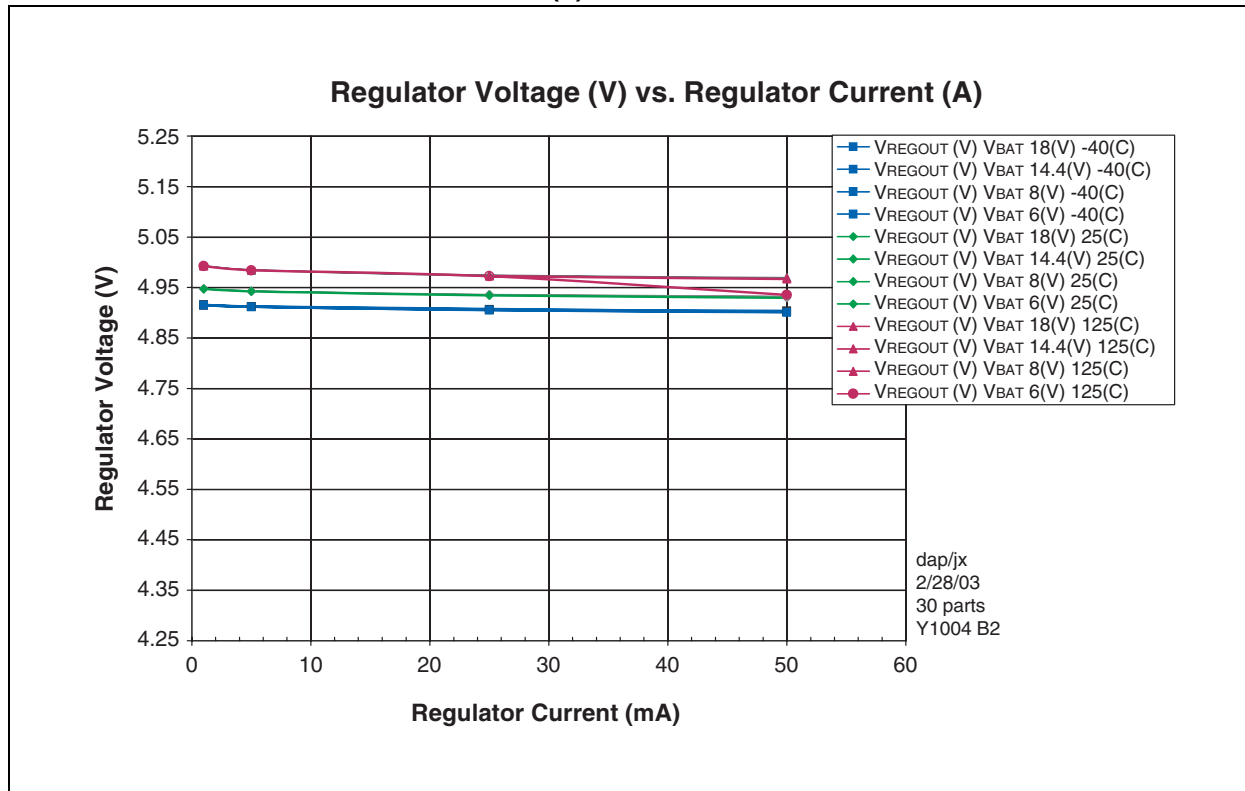
**2.4 Timing Diagrams and Specifications****FIGURE 2-1: BUS TIMING DIAGRAM****FIGURE 2-2: REGULATOR TIMING DIAGRAM ON CS/WAKE SIGNAL**

# MCP201

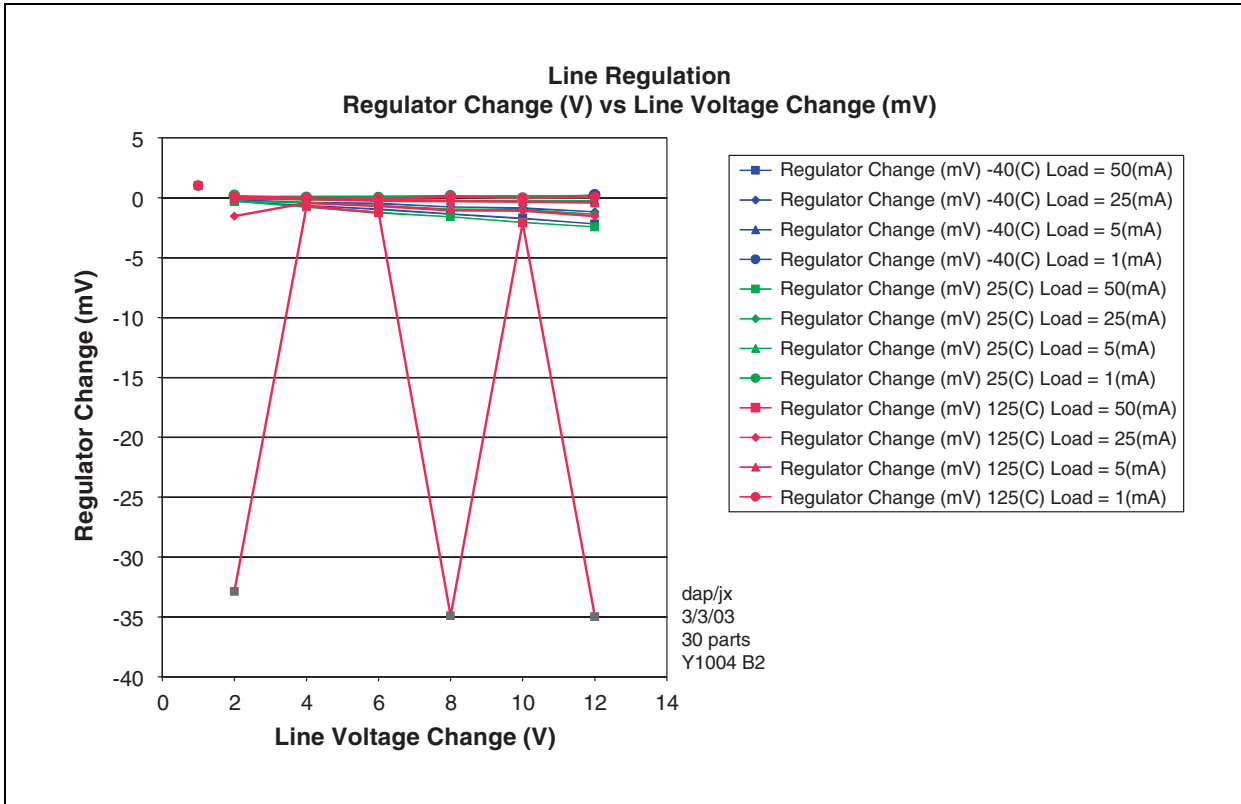
**FIGURE 2-3: REGULATOR TIMING DIAGRAM ON BUS ACTIVITY**

**FIGURE 2-4: POR DIAGRAM**


**3.0 CHARACTERIZATION GRAPHS****FIGURE 3-1:  $I_{DD}(mA)$  vs.  $V_{BAT}$** 

# MCP201

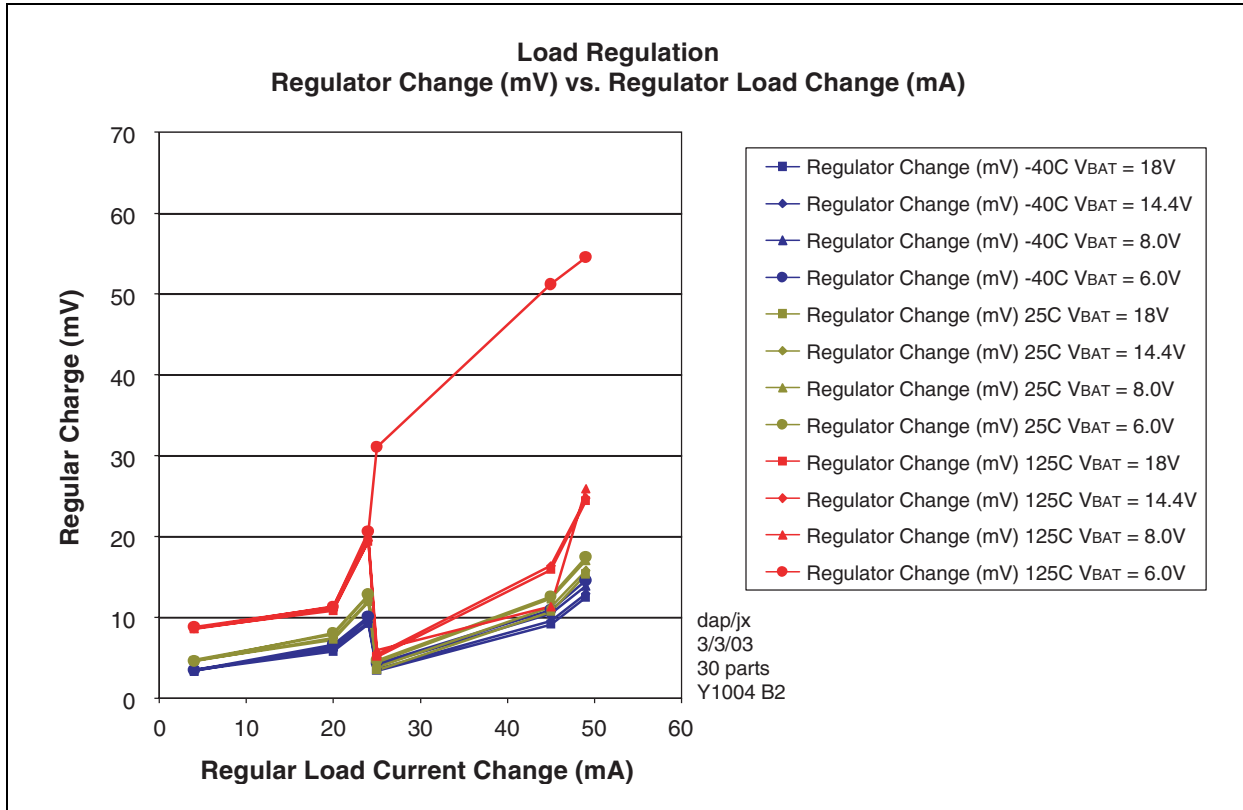
**FIGURE 3-2: REGULATOR VOLTAGE (V) VS. REGULATOR CURRENT**


**FIGURE 3-3: REGULATOR CHANGE (V) VS. LINE VOLTAGE CHANGE**

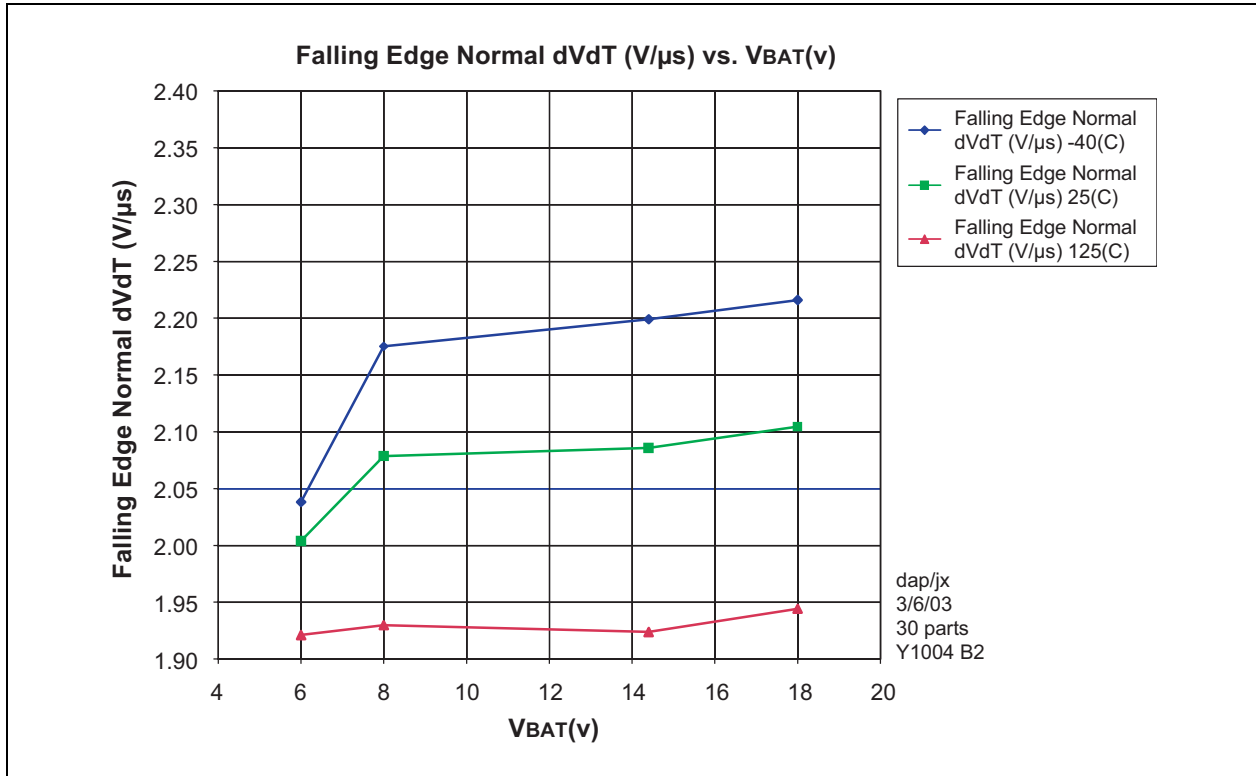


# MCP201

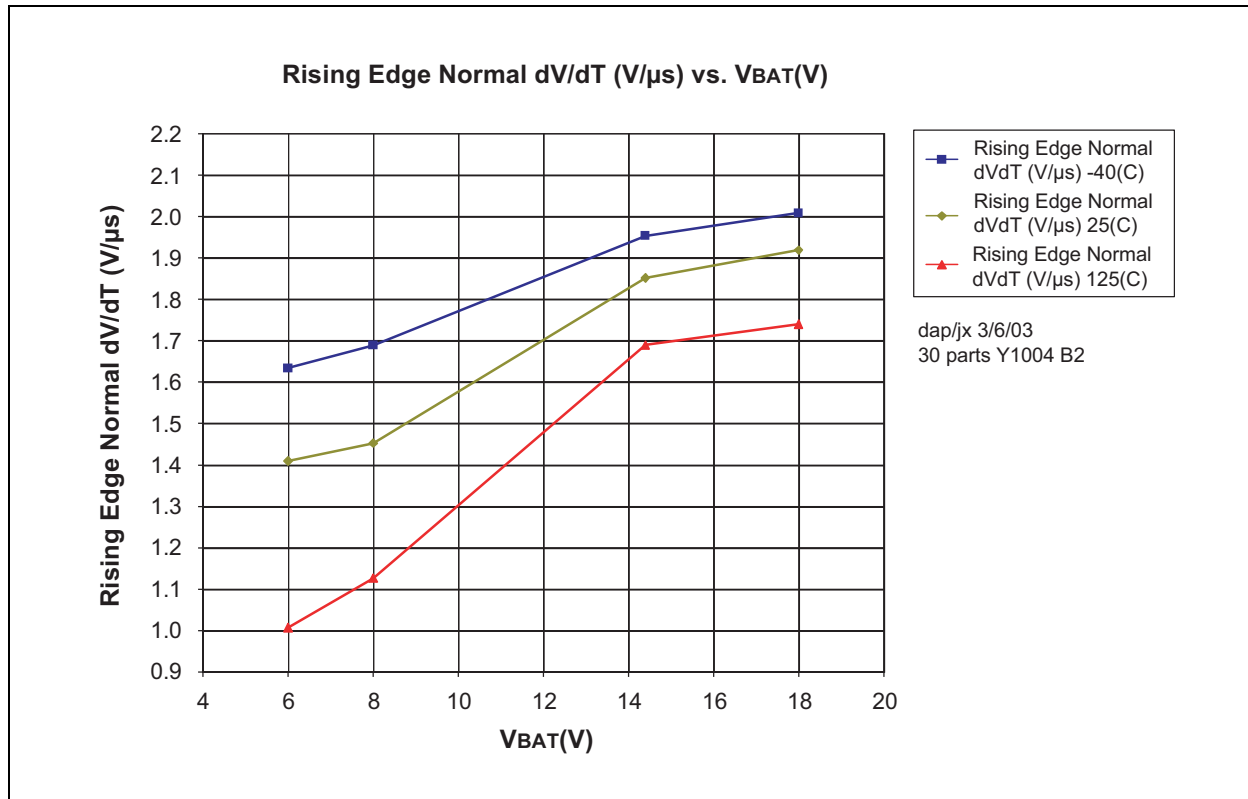
FIGURE 3-4: LOAD REGULATION REGULATOR CHANGE VS. REGULATOR LOAD CHANGE

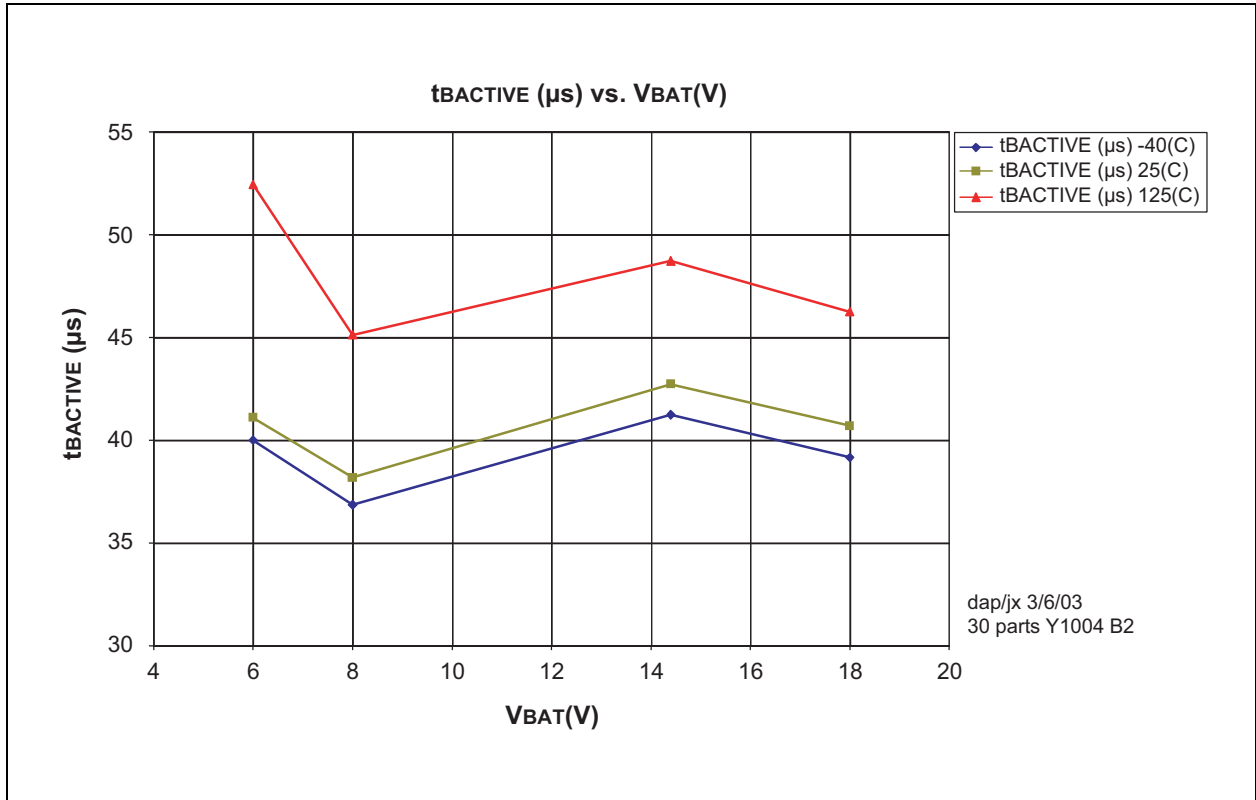




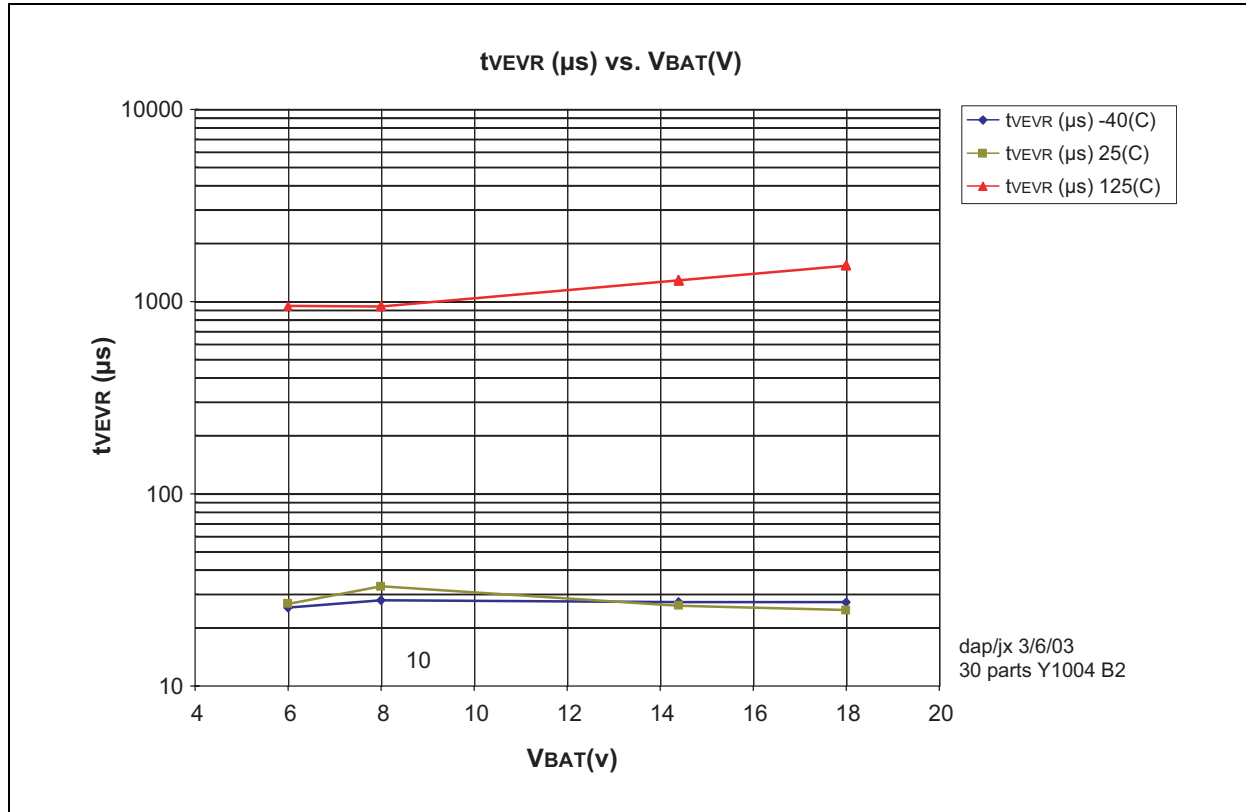
**FIGURE 3-5: FALLING EDGE NORMAL DV/DT VS. VBAT**

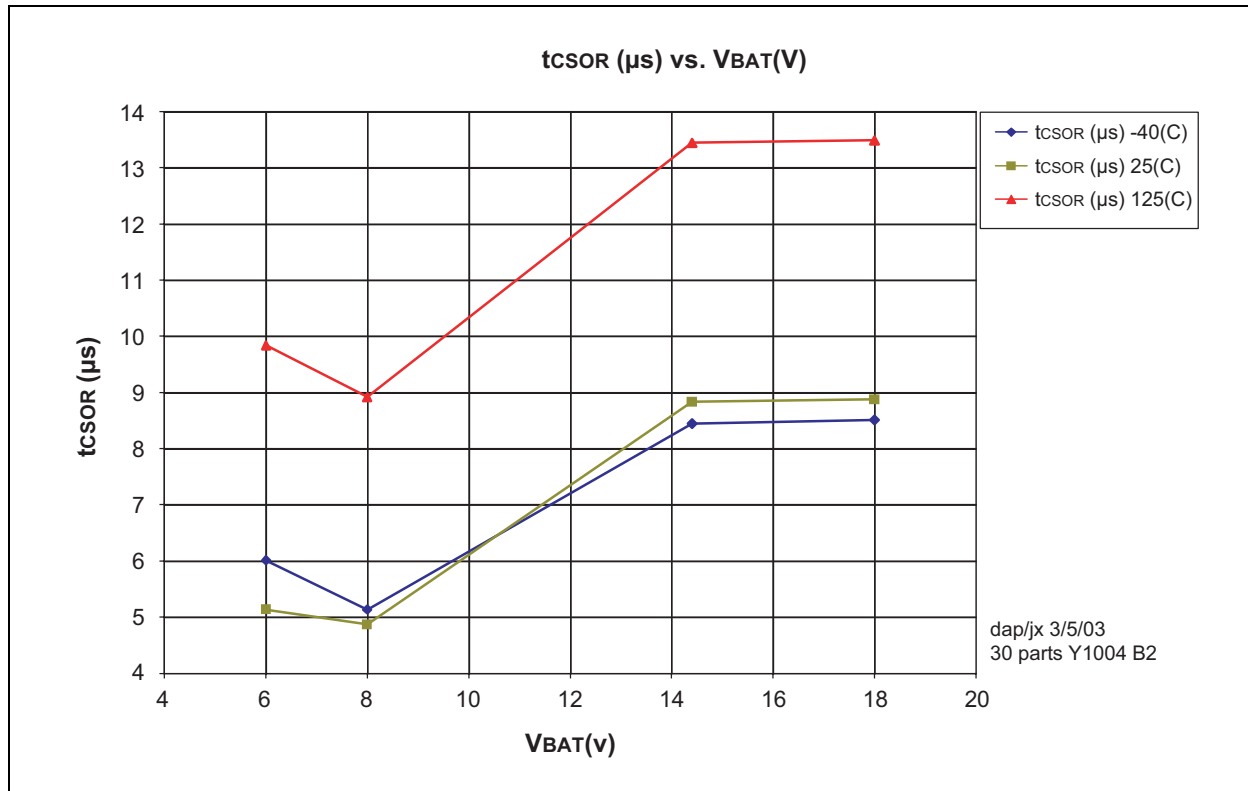
# MCP201

**FIGURE 3-6: RISING EDGE NORMAL DV/DT VS. VBAT**

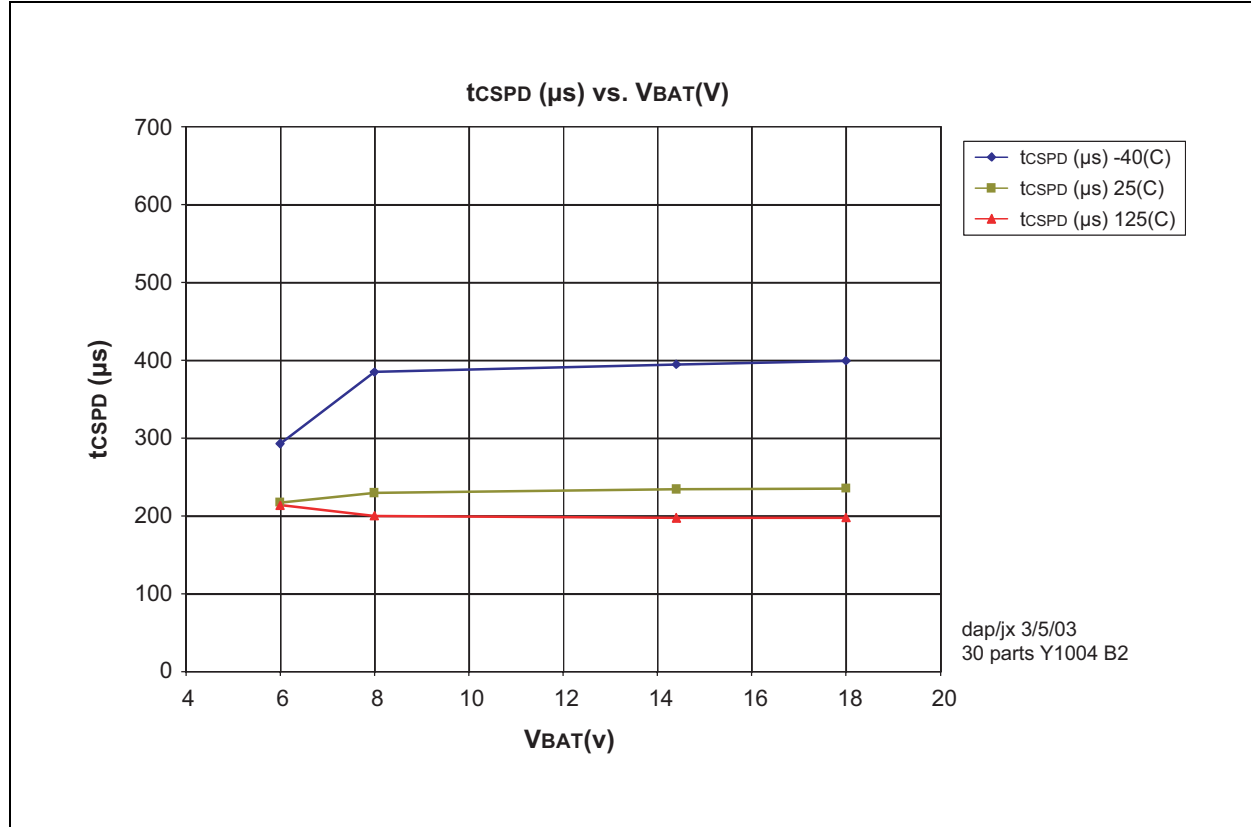
**FIGURE 3-7: BUS ACTIVE VS. VBAT**

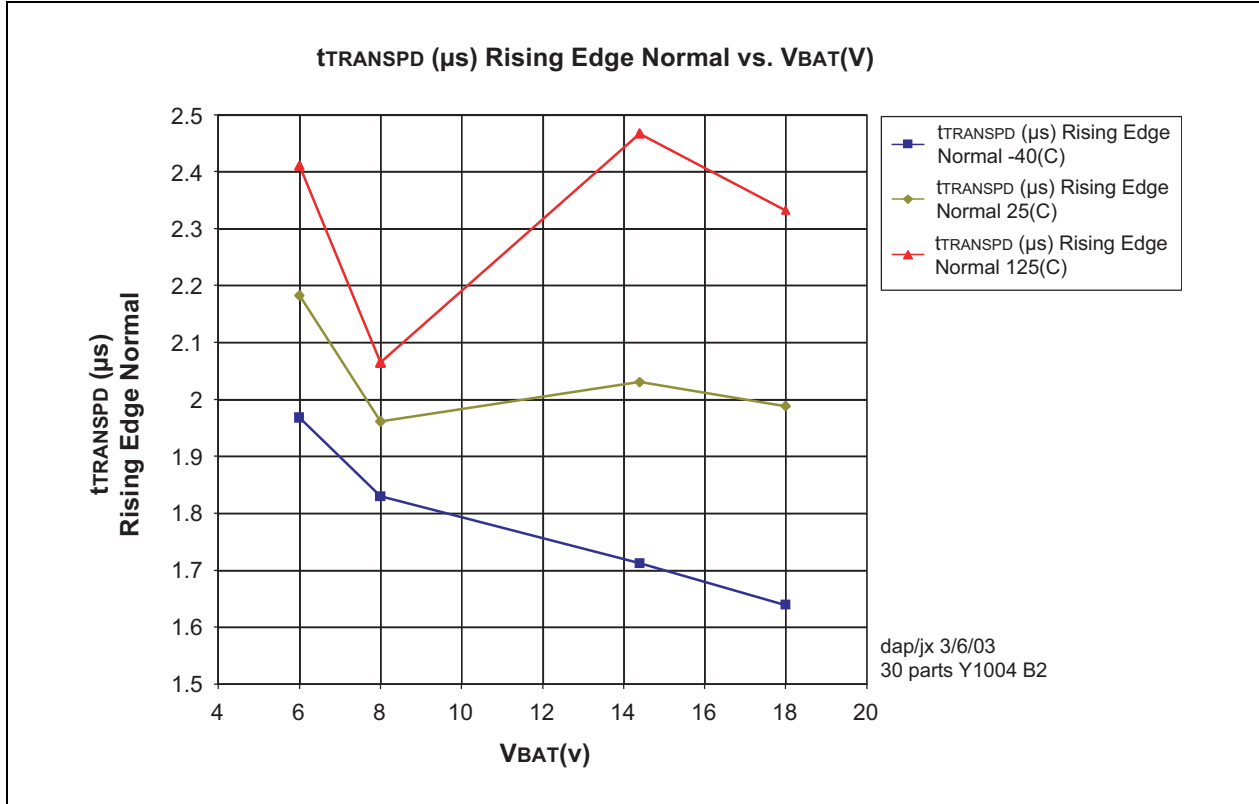
# MCP201

**FIGURE 3-8: VOLTAGE REGULATOR ACTIVE TIME VS. VBAT**


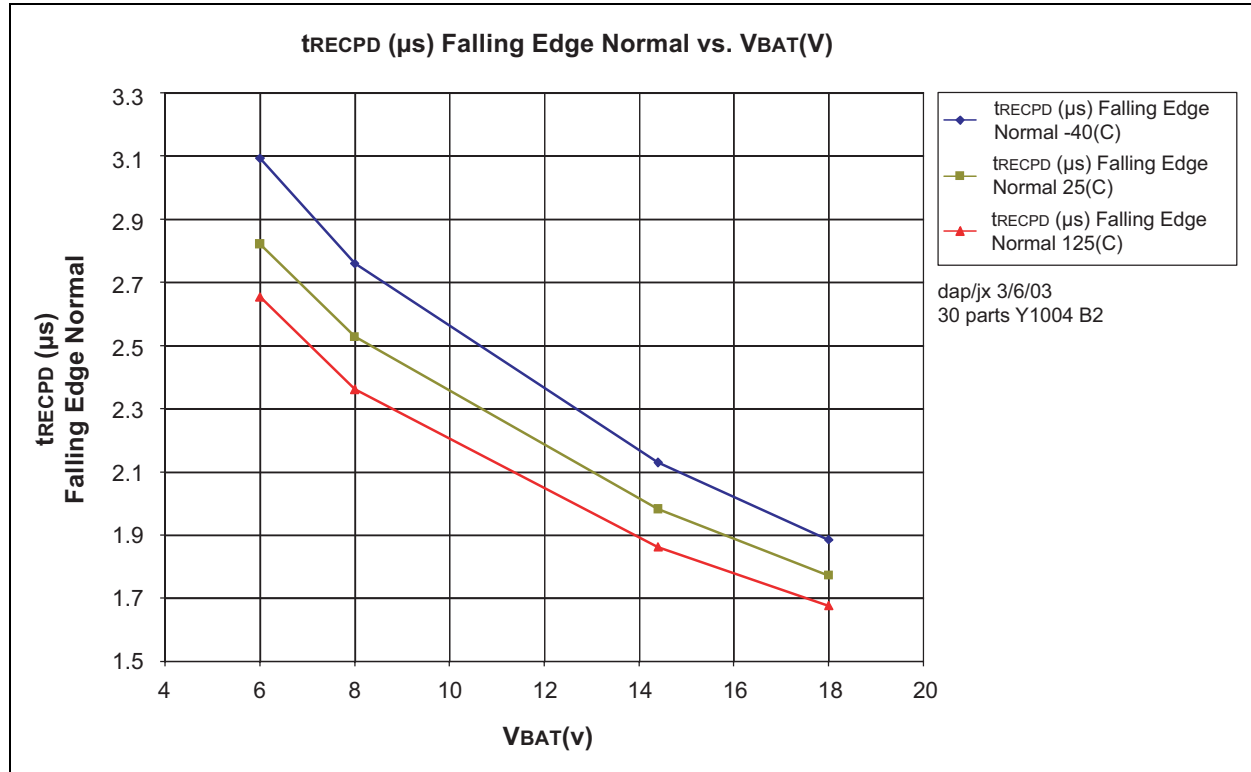
**FIGURE 3-9: CHIP SELECT TO OPERATION READY**

# MCP201

**FIGURE 3-10: CHIP SELECT TO POWER DOWN**

**FIGURE 3-11: PROPAGATION DELAY OF TRANSMITTER**

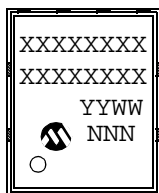
# MCP201

**FIGURE 3-12: PROPAGATION DELAY OF RECEIVER**


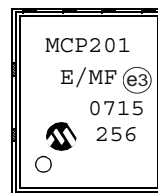


**4.0 PACKAGING INFORMATION****4.1 Package Marking Information**

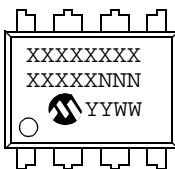
8-Lead DFN-S



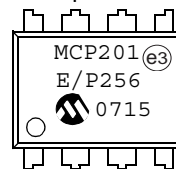
Example:



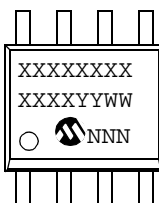
8-Lead PDIP (300 mil)



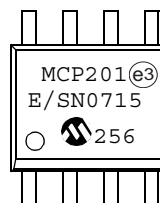
Example:



8-Lead SOIC (150 mil)



Example:



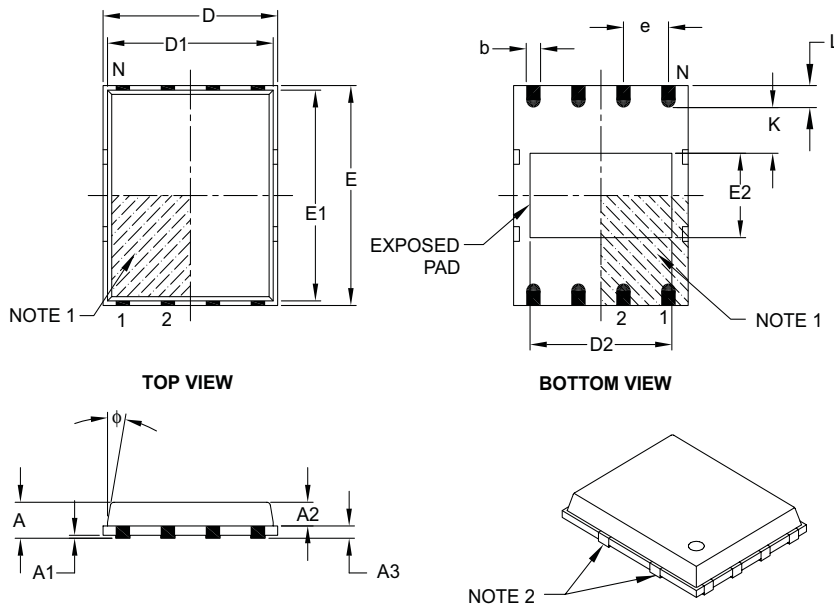
|                |        |  |
|----------------|--------|--|
| <b>Legend:</b> | XX...X | Customer-specific information  |
|                | Y      | Year code (last digit of calendar year)  |
|                | YY     | Year code (last 2 digits of calendar year)   |
|                | WW     | Week code (week of January 1 is week '01')   |
|                | NNN    | Alphanumeric traceability code   |
|                | (e3)   | Pb-free JEDEC designator for Matte Tin (Sn)  |
|                | *      | This package is Pb-free. The Pb-free JEDEC designator (e3) can be found on the outer packaging for this package. |

**Note:** In the event the full Microchip part number cannot be marked on one line, it will be carried over to the next line, thus limiting the number of available characters for customer-specific information.

# MCP201

## 8-Lead Plastic Dual Flat, No Lead Package (MF) – 6x5 mm Body [DFN-S] PUNCH SINGULATED

**Note:** For the most current package drawings, please see the Microchip Packaging Specification located at <http://www.microchip.com/packaging>



| Dimension Limits         | Units  | MILLIMETERS |      |      |
|--------------------------|--------|-------------|------|------|
|                          |        | MIN         | NOM  | MAX  |
| Number of Pins           | N      | 8           |      |      |
| Pitch                    | e      | 1.27 BSC    |      |      |
| Overall Height           | A      | –           | 0.85 | 1.00 |
| Molded Package Thickness | A2     | –           | 0.65 | 0.80 |
| Standoff                 | A1     | 0.00        | 0.01 | 0.05 |
| Base Thickness           | A3     | 0.20 REF    |      |      |
| Overall Length           | D      | 4.92 BSC    |      |      |
| Molded Package Length    | D1     | 4.67 BSC    |      |      |
| Exposed Pad Length       | D2     | 3.85        | 4.00 | 4.15 |
| Overall Width            | E      | 5.99 BSC    |      |      |
| Molded Package Width     | E1     | 5.74 BSC    |      |      |
| Exposed Pad Width        | E2     | 2.16        | 2.31 | 2.46 |
| Contact Width            | b      | 0.35        | 0.40 | 0.47 |
| Contact Length           | L      | 0.50        | 0.60 | 0.75 |
| Contact-to-Exposed Pad   | K      | 0.20        | –    | –    |
| Model Draft Angle Top    | $\phi$ | –           | –    | 12°  |

### Notes:

- Pin 1 visual index feature may vary, but must be located within the hatched area.
- Package may have one or more exposed tie bars at ends.
- Dimensioning and tolerancing per ASME Y14.5M.

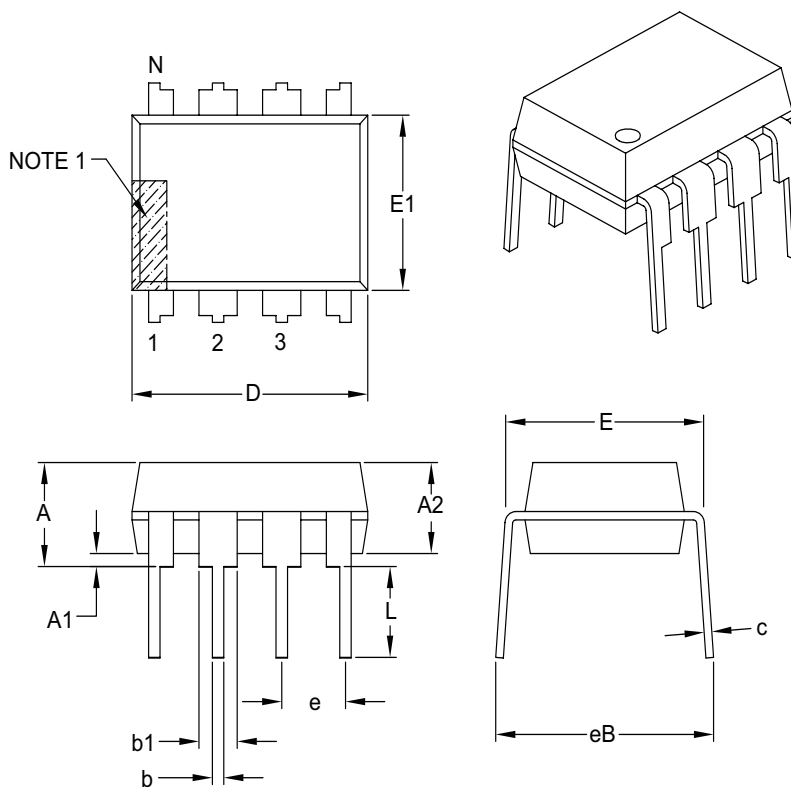
BSC: Basic Dimension. Theoretically exact value shown without tolerances.

REF: Reference Dimension, usually without tolerance, for information purposes only.

Microchip Technology Drawing C04-113B

**8-Lead Plastic Dual In-Line (P) – 300 mil Body [PDIP]**

**Note:** For the most current package drawings, please see the Microchip Packaging Specification located at <http://www.microchip.com/packaging>



| Dimension Limits           | Units | INCHES   |      |      |
|----------------------------|-------|----------|------|------|
|                            |       | MIN      | NOM  | MAX  |
| Number of Pins             | N     | 8        |      |      |
| Pitch                      | e     | .100 BSC |      |      |
| Top to Seating Plane       | A     | –        | –    | .210 |
| Molded Package Thickness   | A2    | .115     | .130 | .195 |
| Base to Seating Plane      | A1    | .015     | –    | –    |
| Shoulder to Shoulder Width | E     | .290     | .310 | .325 |
| Molded Package Width       | E1    | .240     | .250 | .280 |
| Overall Length             | D     | .348     | .365 | .400 |
| Tip to Seating Plane       | L     | .115     | .130 | .150 |
| Lead Thickness             | c     | .008     | .010 | .015 |
| Upper Lead Width           | b1    | .040     | .060 | .070 |
| Lower Lead Width           | b     | .014     | .018 | .022 |
| Overall Row Spacing §      | eB    | –        | –    | .430 |

**Notes:**

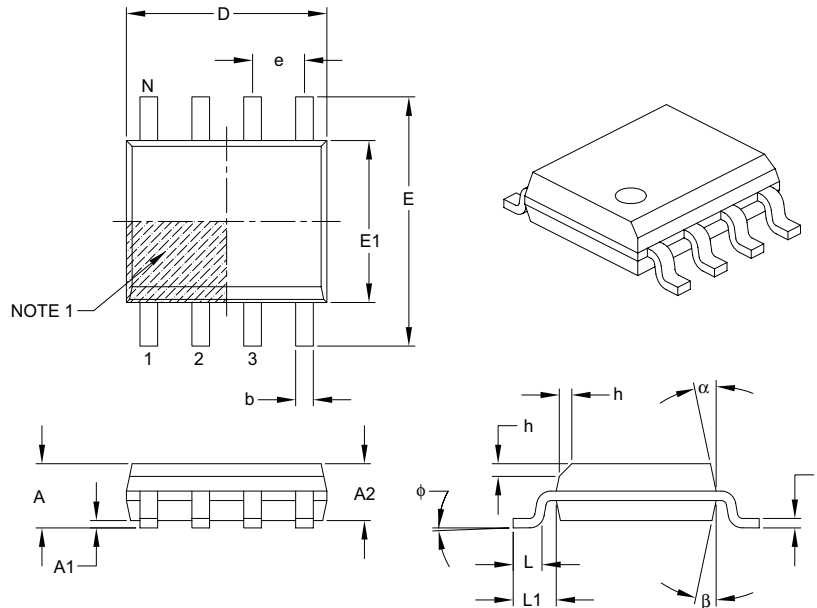
- Pin 1 visual index feature may vary, but must be located with the hatched area.
- § Significant Characteristic.
- Dimensions D and E1 do not include mold flash or protrusions. Mold flash or protrusions shall not exceed .010" per side.
- Dimensioning and tolerancing per ASME Y14.5M.

BSC: Basic Dimension. Theoretically exact value shown without tolerances.

# MCP201

## 8-Lead Plastic Small Outline (SN) – Narrow, 3.90 mm Body [SOIC]

**Note:** For the most current package drawings, please see the Microchip Packaging Specification located at <http://www.microchip.com/packaging>



| Dimension Limits         | Units    | MILLIMETERS |     |      |
|--------------------------|----------|-------------|-----|------|
|                          |          | MIN         | NOM | MAX  |
| Number of Pins           | N        | 8           |     |      |
| Pitch                    | e        | 1.27 BSC    |     |      |
| Overall Height           | A        | –           | –   | 1.75 |
| Molded Package Thickness | A2       | 1.25        | –   | –    |
| Standoff §               | A1       | 0.10        | –   | 0.25 |
| Overall Width            | E        | 6.00 BSC    |     |      |
| Molded Package Width     | E1       | 3.90 BSC    |     |      |
| Overall Length           | D        | 4.90 BSC    |     |      |
| Chamfer (optional)       | h        | 0.25        | –   | 0.50 |
| Foot Length              | L        | 0.40        | –   | 1.27 |
| Footprint                | L1       | 1.04 REF    |     |      |
| Foot Angle               | $\phi$   | 0°          | –   | 8°   |
| Lead Thickness           | c        | 0.17        | –   | 0.25 |
| Lead Width               | b        | 0.31        | –   | 0.51 |
| Mold Draft Angle Top     | $\alpha$ | 5°          | –   | 15°  |
| Mold Draft Angle Bottom  | $\beta$  | 5°          | –   | 15°  |

### Notes:

- Pin 1 visual index feature may vary, but must be located within the hatched area.
- § Significant Characteristic.
- Dimensions D and E1 do not include mold flash or protrusions. Mold flash or protrusions shall not exceed 0.15 mm per side.
- Dimensioning and tolerancing per ASME Y14.5M.

BSC: Basic Dimension. Theoretically exact value shown without tolerances.

REF: Reference Dimension, usually without tolerance, for information purposes only.

Microchip Technology Drawing C04-057B

## **APPENDIX A: REVISION HISTORY**

### **Revision F (January 2007)**

This revision includes updates to the packaging diagrams.

# MCP201

---

---

NOTES:

**PRODUCT IDENTIFICATION SYSTEM**

To order or obtain information, e.g., on pricing or delivery, refer to the factory or the listed sales office.

| <u>PART NO.</u>    | <u>X</u>          | <u>/XX</u>   |   |
|--------------------|-------------------|--|---|
| Device             | Temperature Range | Package  |   |
| Device:            | MCP201:           | LIN Transceiver with Voltage Regulator                 |   |
|                    | MCP201T:          | LIN Transceiver with Voltage Regulator (Tape and Reel) |   |
| Temperature Range: | I                 | = -40°C to +85°C                                       |   |
|                    | E                 | = -40°C to +125°C                                      |   |
| Package:           | MF                | = Dual Flatpack, No-Lead (6x5 mm Body), 8-lead         |   |
|                    | P                 | = Plastic DIP (300 mil Body), 8-lead                   |   |
|                    | SN                | = Plastic SOIC (150 mil Body), 8-lead                  |   |
|                    |                   |  | <b>Examples:</b>  |
|                    |                   |  | a) MCP201-E/SN: Extended Temperature, SOIC package.                   |
|                    |                   |  | b) MCP201-E/P: Extended Temperature, PDIP package.                    |
|                    |                   |  | c) MCP201-I/SN: Industrial Temperature, SOIC package.                 |
|                    |                   |  | d) MCP201-I/P: Industrial Temperature, PDIP package.                  |
|                    |                   |  | e) MCP201T-I/SN: Tape and Reel, Industrial Temperature, SOIC package. |
|                    |                   |  | f) MCP201T-E/SN: Tape and Reel, Extended Temperature, SOIC package.   |
|                    |                   |  | g) MCP201-E/MF: Extended Temperature, DFN package.                    |
|                    |                   |  | h) MCP201T-E/MF: Tape and Reel, Extended Temperature, DFN package.    |

# MCP201

---

NOTES:



**Note the following details of the code protection feature on Microchip devices:**

- Microchip products meet the specification contained in their particular Microchip Data Sheet.
- Microchip believes that its family of products is one of the most secure families of its kind on the market today, when used in the intended manner and under normal conditions.
- There are dishonest and possibly illegal methods used to breach the code protection feature. All of these methods, to our knowledge, require using the Microchip products in a manner outside the operating specifications contained in Microchip's Data Sheets. Most likely, the person doing so is engaged in theft of intellectual property.
- Microchip is willing to work with the customer who is concerned about the integrity of their code.
- Neither Microchip nor any other semiconductor manufacturer can guarantee the security of their code. Code protection does not mean that we are guaranteeing the product as "unbreakable."

Code protection is constantly evolving. We at Microchip are committed to continuously improving the code protection features of our products. Attempts to break Microchip's code protection feature may be a violation of the Digital Millennium Copyright Act. If such acts allow unauthorized access to your software or other copyrighted work, you may have a right to sue for relief under that Act.

Information contained in this publication regarding device applications and the like is provided only for your convenience and may be superseded by updates. It is your responsibility to ensure that your application meets with your specifications. MICROCHIP MAKES NO REPRESENTATIONS OR WARRANTIES OF ANY KIND WHETHER EXPRESS OR IMPLIED, WRITTEN OR ORAL, STATUTORY OR OTHERWISE, RELATED TO THE INFORMATION, INCLUDING BUT NOT LIMITED TO ITS CONDITION, QUALITY, PERFORMANCE, MERCHANTABILITY OR FITNESS FOR PURPOSE. Microchip disclaims all liability arising from this information and its use. Use of Microchip devices in life support and/or safety applications is entirely at the buyer's risk, and the buyer agrees to defend, indemnify and hold harmless Microchip from any and all damages, claims, suits, or expenses resulting from such use. No licenses are conveyed, implicitly or otherwise, under any Microchip intellectual property rights.

**Trademarks**

The Microchip name and logo, the Microchip logo, Accuron, dsPIC, KEELOQ, microID, MPLAB, PIC, PICmicro, PICSTART, PRO MATE, PowerSmart, rPIC, and SmartShunt are registered trademarks of Microchip Technology Incorporated in the U.S.A. and other countries.


AmpLab, FilterLab, Migratable Memory, MXDEV, MXLAB, SEEVAL, SmartSensor and The Embedded Control Solutions Company are registered trademarks of Microchip Technology Incorporated in the U.S.A.

Analog-for-the-Digital Age, Application Maestro, CodeGuard, dsPICDEM, dsPICDEM.net, dsPICworks, ECAN, ECONOMONITOR, FanSense, FlexROM, fuzzyLAB, In-Circuit Serial Programming, ICSP, ICEPIC, Linear Active Thermistor, Mindi, MiWi, MPASM, MPLIB, MPLINK, PICkit, PICDEM, PICDEM.net, PICLAB, PICtail, PowerCal, PowerInfo, PowerMate, PowerTool, REAL ICE, rLAB, rPICDEM, Select Mode, Smart Serial, SmartTel, Total Endurance, UNI/O, WiperLock and ZENA are trademarks of Microchip Technology Incorporated in the U.S.A. and other countries.

SQTP is a service mark of Microchip Technology Incorporated in the U.S.A.

All other trademarks mentioned herein are property of their respective companies.

© 2007, Microchip Technology Incorporated, Printed in the U.S.A., All Rights Reserved.

 Printed on recycled paper.

**QUALITY MANAGEMENT SYSTEM**  
**CERTIFIED BY DNV**  
**== ISO/TS 16949:2002 ==**

*Microchip received ISO/TS-16949:2002 certification for its worldwide headquarters, design and wafer fabrication facilities in Chandler and Tempe, Arizona, Gresham, Oregon and Mountain View, California. The Company's quality system processes and procedures are for its PIC<sup>®</sup> MCUs and dsPIC DSCs, KEELOQ<sup>®</sup> code hopping devices, Serial EEPROMs, microperipherals, nonvolatile memory and analog products. In addition, Microchip's quality system for the design and manufacture of development systems is ISO 9001:2000 certified.*



## WORLDWIDE SALES AND SERVICE

### AMERICAS

**Corporate Office**  
2355 West Chandler Blvd.  
Chandler, AZ 85224-6199  
Tel: 480-792-7200  
Fax: 480-792-7277  
Technical Support:  
<http://support.microchip.com>  
Web Address:  
[www.microchip.com](http://www.microchip.com)

**Atlanta**  
Duluth, GA  
Tel: 678-957-9614  
Fax: 678-957-1455

**Boston**  
Westborough, MA  
Tel: 774-760-0087  
Fax: 774-760-0088

**Chicago**  
Itasca, IL  
Tel: 630-285-0071  
Fax: 630-285-0075

**Dallas**  
Addison, TX  
Tel: 972-818-7423  
Fax: 972-818-2924

**Detroit**  
Farmington Hills, MI  
Tel: 248-538-2250  
Fax: 248-538-2260

**Kokomo**  
Kokomo, IN  
Tel: 765-864-8360  
Fax: 765-864-8387

**Los Angeles**  
Mission Viejo, CA  
Tel: 949-462-9523  
Fax: 949-462-9608

**Santa Clara**  
Santa Clara, CA  
Tel: 408-961-6444  
Fax: 408-961-6445

**Toronto**  
Mississauga, Ontario,  
Canada  
Tel: 905-673-0699  
Fax: 905-673-6509

### ASIA/PACIFIC

**Asia Pacific Office**  
Suites 3707-14, 37th Floor  
Tower 6, The Gateway  
Harbour City, Kowloon  
Hong Kong  
Tel: 852-2401-1200  
Fax: 852-2401-3431

**Australia - Sydney**  
Tel: 61-2-9868-6733  
Fax: 61-2-9868-6755

**China - Beijing**  
Tel: 86-10-8528-2100  
Fax: 86-10-8528-2104

**China - Chengdu**  
Tel: 86-28-8665-5511  
Fax: 86-28-8665-7889

**China - Fuzhou**  
Tel: 86-591-8750-3506  
Fax: 86-591-8750-3521

**China - Hong Kong SAR**  
Tel: 852-2401-1200  
Fax: 852-2401-3431

**China - Qingdao**  
Tel: 86-532-8502-7355  
Fax: 86-532-8502-7205

**China - Shanghai**  
Tel: 86-21-5407-5533  
Fax: 86-21-5407-5066

**China - Shenyang**  
Tel: 86-24-2334-2829  
Fax: 86-24-2334-2393

**China - Shenzhen**  
Tel: 86-755-8203-2660  
Fax: 86-755-8203-1760

**China - Shunde**  
Tel: 86-757-2839-5507  
Fax: 86-757-2839-5571

**China - Wuhan**  
Tel: 86-27-5980-5300  
Fax: 86-27-5980-5118

**China - Xian**  
Tel: 86-29-8833-7250  
Fax: 86-29-8833-7256

### ASIA/PACIFIC

**India - Bangalore**  
Tel: 91-80-4182-8400  
Fax: 91-80-4182-8422

**India - New Delhi**  
Tel: 91-11-4160-8631  
Fax: 91-11-4160-8632

**India - Pune**  
Tel: 91-20-2566-1512  
Fax: 91-20-2566-1513

**Japan - Yokohama**  
Tel: 81-45-471- 6166  
Fax: 81-45-471-6122

**Korea - Gumi**  
Tel: 82-54-473-4301  
Fax: 82-54-473-4302

**Korea - Seoul**  
Tel: 82-2-554-7200  
Fax: 82-2-558-5932 or  
82-2-558-5934

**Malaysia - Penang**  
Tel: 60-4-646-8870  
Fax: 60-4-646-5086

**Philippines - Manila**  
Tel: 63-2-634-9065  
Fax: 63-2-634-9069

**Singapore**  
Tel: 65-6334-8870  
Fax: 65-6334-8850

**Taiwan - Hsin Chu**  
Tel: 886-3-572-9526  
Fax: 886-3-572-6459

**Taiwan - Kaohsiung**  
Tel: 886-7-536-4818  
Fax: 886-7-536-4803

**Taiwan - Taipei**  
Tel: 886-2-2500-6610  
Fax: 886-2-2508-0102

**Thailand - Bangkok**  
Tel: 66-2-694-1351  
Fax: 66-2-694-1350

### EUROPE

**Austria - Wels**  
Tel: 43-7242-2244-39  
Fax: 43-7242-2244-393

**Denmark - Copenhagen**  
Tel: 45-4450-2828  
Fax: 45-4485-2829

**France - Paris**  
Tel: 33-1-69-53-63-20  
Fax: 33-1-69-30-90-79

**Germany - Munich**  
Tel: 49-89-627-144-0  
Fax: 49-89-627-144-44

**Italy - Milan**  
Tel: 39-0331-742611  
Fax: 39-0331-466781

**Netherlands - Drunen**  
Tel: 31-416-690399  
Fax: 31-416-690340

**Spain - Madrid**  
Tel: 34-91-708-08-90  
Fax: 34-91-708-08-91

**UK - Wokingham**  
Tel: 44-118-921-5869  
Fax: 44-118-921-5820

## OUR CERTIFICATE

DiGi provide top-quality products and perfect service for customer worldwide through standardization, technological innovation and continuous improvement. DiGi through third-party certification, we strictly control the quality of products and services. Welcome your RFQ to

Email: [Info@DiGi-Electronics.com](mailto:Info@DiGi-Electronics.com)



Tel: +00 852-30501935

RFQ Email: [Info@DiGi-Electronics.com](mailto:Info@DiGi-Electronics.com)

DiGi is a global authorized distributor of electronic components.