

MIC23051-C4YML-TR Datasheet

www.digi-electronics.com

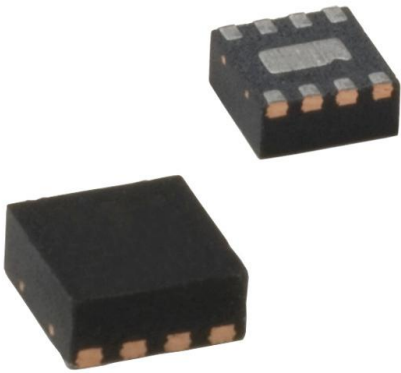

<https://www.DiGi-Electronics.com>

DiGi Electronics Part Number	MIC23051-C4YML-TR-DG
Manufacturer	Microchip Technology
Manufacturer Product Number	MIC23051-C4YML-TR
Description	IC REG BUCK 1.2V 600MA 8MLF
Detailed Description	Buck Switching Regulator IC Positive Fixed 1.2V 1 Output 600mA 8-VFDFN Exposed Pad, 8-MLF®



Tel: +00 852-30501935

RFQ Email: Info@DiGi-Electronics.com

DiGi is a global authorized distributor of electronic components.

Purchase and inquiry

Manufacturer Product Number:

MIC23051-C4YML-TR

Series:

HyperLight Load®

Function:

Step-Down

Topology:

Buck

Number of Outputs:

1

Voltage - Input (Max):

5.5V

Voltage - Output (Max):

-

Frequency - Switching:

4MHz

Operating Temperature:

-40°C ~ 125°C (Tj)

Package / Case:

8-VDFN Exposed Pad, 8-MLF®

Base Product Number:

MIC23051

Manufacturer:

Microchip Technology

Product Status:

Active

Output Configuration:

Positive

Output Type:

Fixed

Voltage - Input (Min):

2.7V

Voltage - Output (Min/Fixed):

1.2V

Current - Output:

600mA

Synchronous Rectifier:

Yes

Mounting Type:

Surface Mount

Supplier Device Package:

8-MLF® (2x2)

Environmental & Export classification

RoHS Status:

ROHS3 Compliant

REACH Status:

REACH Unaffected

HTSUS:

8542.39.0001

Moisture Sensitivity Level (MSL):

1 (Unlimited)

ECCN:

EAR99



MIC23051

4 MHz PWM Buck Regulator with HyperLight Load[®] and Voltage Scaling

Features

- Input Voltage: 2.7V to 5.5V
- 600 mA Output Current
- Fixed Output Voltage 1.25V, 1.2V, 1.4V and 1.8V with Voltage Scaling Down Using VSC pin to: 0.95V, 1.0V, 1.15V and 1.0V
- Ultra-Fast Transient Response
- 20 μ A Typical Quiescent Current
- 4 MHz CCM PWM Operation in Normal Mode
- 0.47 μ H to 2.2 μ H Inductor
- Low Voltage Output Ripple
 - 25 mV_{PP} Ripple in HyperLight Load[®] Mode
 - 3 mV Output Voltage Ripple in Full PWM Mode
- >93% Efficiency
- ~85% at 1 mA
- Micropower shutdown
- Available in 8-pin 2 mm x 2 mm DFN Package
- -40°C to +125°C Junction Temperature Range

Applications

- Cellular Phones
- Digital Cameras
- Portable Media Players
- Wireless LAN Cards
- WiFi/WiMax/WiBro Modules
- USB Powered Devices

General Description

The MIC23051 is a high efficiency 600 mA PWM synchronous buck (step-down) regulator featuring HyperLight Load[®], a patented switching scheme that offers best in class light load efficiency and transient performance while providing very small external components and low output ripple at all loads.

The MIC23051 has an output voltage scaling feature that toggles between two different voltage levels.

The MIC23051 also has a very low typical quiescent current draw of 20 μ A and can achieve over 85% efficiency even at 1 mA. The device allows operation with a tiny inductor ranging from 0.47 μ H to 2.2 μ H and uses a small output capacitor that enables a sub 1 mm height solution.

In contrast to traditional light load schemes, HyperLight Load[®] architecture does not need to trade off control speed to obtain low standby currents and in doing so the device only needs a small output capacitor to absorb the load transient as the powered device goes from light load to full load.

At higher loads the MIC23051 provides a constant switching frequency of greater than 4 MHz while providing peak efficiencies greater than 93%.

The MIC23051 is available in fixed output voltage options eliminating external feedback components. The MIC23051 is available in an 8-pin 2 mm x 2 mm DFN with a junction operating range from -40°C to +125°C.

Package Type

8-Pin 2 mm x 2 mm DFN
(Top View)

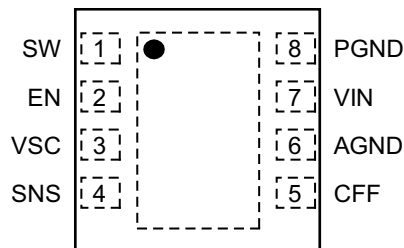

MIC23051

Typical Application Circuit

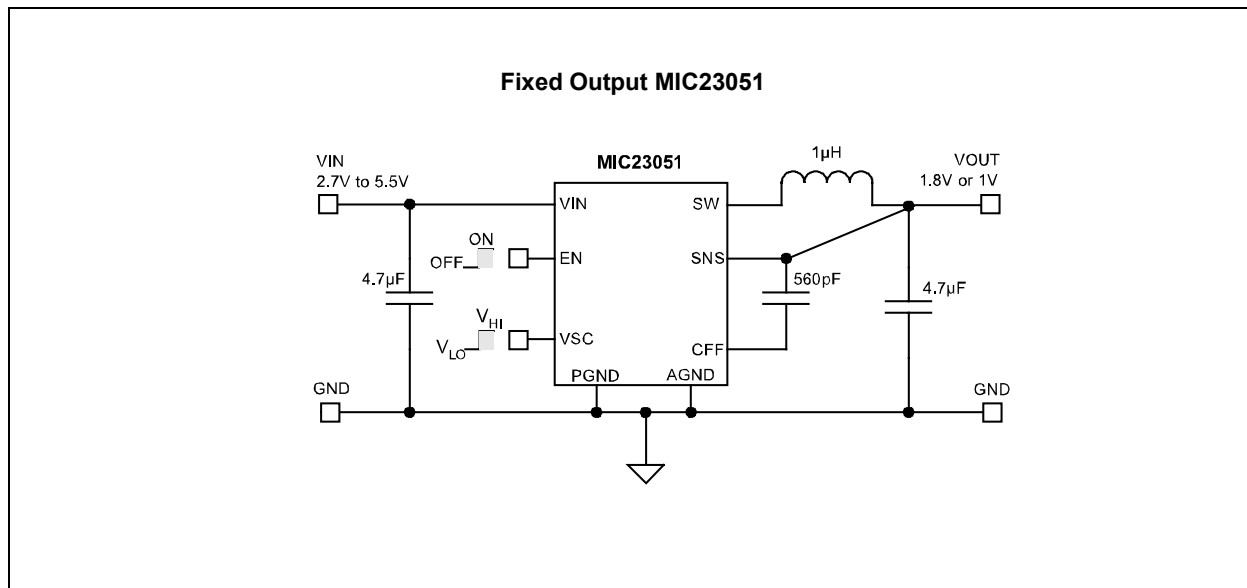

Functional Block Diagram

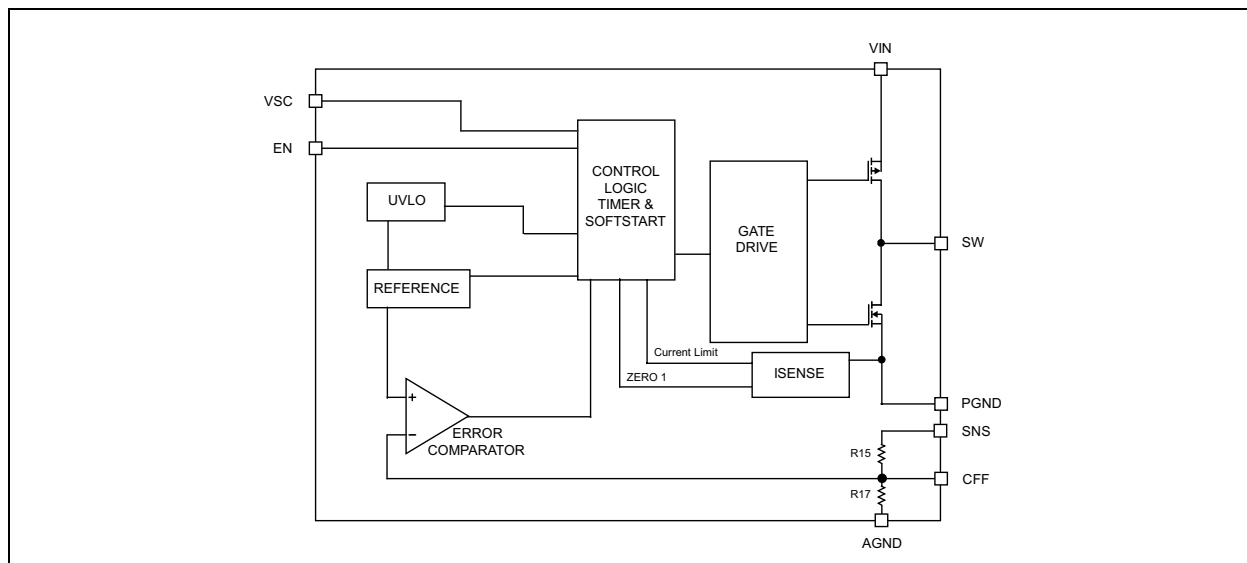

1.0 ELECTRICAL CHARACTERISTICS**Absolute Maximum Ratings †**

Supply Voltage (V_{IN})	+6V
Output Switch Voltage (V_{SW})	+6V
Output Switch Current (I_{SW})	2A
Logic Input Voltage (V_{EN}, V_{SC})	-0.3V to V_{IN}
Storage Temperature Range (T_S)	-65°C to +150°C
ESD Rating (Note 1)	3 kV

Operating Ratings ‡

Supply Voltage (V_{IN})	+2.7V to +5.5V
Logic Input Voltage (V_{EN})	-0.3V to V_{IN}
Operating Junction Temperature (T_J)	-40°C ≤ T_J ≤ +125°C

† **Notice:** Stresses above those listed under “Absolute Maximum Ratings” may cause permanent damage to the device. This is a stress rating only and functional operation of the device at those or any other conditions above those indicated in the operational sections of this specification is not intended. Exposure to maximum rating conditions for extended periods may affect device reliability. Specifications are for packaged product only.

‡ **Notice:** The device is not guaranteed to function outside its operating ratings.

Note 1: Devices are ESD sensitive. Handling precautions are recommended. Human body model, 1.5 kΩ in series with 100 pF.

TABLE 1-1: ELECTRICAL CHARACTERISTICS

Electrical Characteristics: $T_A = 25^\circ\text{C}$, $V_{IN} = V_{EN} = 3.6\text{V}$; $L = 1\ \mu\text{H}$; $C_{FF} = 560\ \text{pF}$; $C_{OUT} = 4.7\ \mu\text{F}$; $I_{OUT} = 20\ \text{mA}$;
Bold values indicate $-40^\circ\text{C} \leq T_J \leq +125^\circ\text{C}$; unless otherwise specified. Specification for packaged product only.

Parameter	Symbol	Min.	Typ.	Max.	Units	Conditions
Supply Voltage Range	V_{IN}	2.7	—	5.5	V	—
Undervoltage Lockout Threshold	UVLO	2.45	2.55	2.65	V	Turn-On
UVLO Hysteresis	—	—	100	—	mV	—
Quiescent Current, Hyper Light Load [®] Mode	I_Q	—	20	35	μA	$I_{OUT} = 0\ \text{mA}$, $SNS > 1.8$
Shutdown Current	I_{SHD}	—	0.01	4	μA	$V_{EN} = 0\text{V}$; $V_{IN} = 5.5\text{V}$
Output Voltage Accuracy	—	-2.5	—	+2.5	%	V_{SC} High; $V_{IN} = 3.0\text{V}$; $I_{LOAD} = 20\ \text{mA}$
	—	-2.5	—	+2.5		V_{SC} Low; $V_{IN} = 3.0\text{V}$; $I_{LOAD} = 20\ \text{mA}$
SNS Pin Input current	—	—	1	—	μA	$V_{OUT} = 1\text{V}$
Current Limit in PWM Mode	—	0.65	1	1.7	A	$SNS = 0.9 \cdot V_{OUT(NOM)}$
Output Voltage Line Regulation	—	—	0.5	—	%	$V_{IN} = 3.0\text{V}$ to 5.5V , $V_{SC} = 3.6\text{V}$, $I_{LOAD} = 20\ \text{mA}$,
	—	—		—		$V_{IN} = 3.0\text{V}$ to 5.5V , $V_{SC} = 0\text{V}$, $I_{LOAD} = 20\ \text{mA}$,
Output Voltage Load Regulation	—	—	0.3	—	%	$20\ \text{mA} < I_{LOAD} < 500\ \text{mA}$, $V_{SC} = 3.6\text{V}$
	—	—		—		$20\ \text{mA} < I_{LOAD} < 500\ \text{mA}$, $V_{SC} = 0\text{V}$
Maximum Duty Cycle	—	80	89	—	%	$SNS \leq V_{NOM}$, $V_{OUT} = 1.8\text{V}$
PWM Switch On-Resistance	$R_{DS(ON)-PMOS}$	—	0.45	—	Ω	$I_{SW} = 100\ \text{mA}$ PMOS
	$R_{DS(ON)-NMOS}$	—	0.5	—		$I_{SW} = -100\ \text{mA}$ NMOS
Frequency	f_{SW}	—	4	—	MHz	$V_{SC} = 3.6\text{V}$, $I_{LOAD} = 120\ \text{mA}$
		—	4	—		$V_{SC} = 0\text{V}$, $I_{LOAD} = 120\ \text{mA}$

MIC23051

Electrical Characteristics: $T_A = 25^\circ\text{C}$, $V_{IN} = V_{EN} = 3.6\text{V}$; $L = 1\ \mu\text{H}$; $C_{FF} = 560\ \text{pF}$; $C_{OUT} = 4.7\ \mu\text{F}$; $I_{OUT} = 20\ \text{mA}$;
Bold values indicate $-40^\circ\text{C} \leq T_J \leq +125^\circ\text{C}$; unless otherwise specified. Specification for packaged product only.

Parameter	Symbol	Min.	Typ.	Max.	Units	Conditions
Soft-Start Time	—	—	650	—	μs	$V_{OUT} = 90\%$
VSC Threshold Voltage	—	0.5	—	1.2	V	—
VSC Hysteresis	—	—	20	—	mV	—
Output Transition Time	—	—	800	—	μs	V_{SC} from Low to High
	—	—	800	—		V_{SC} from High to Low
Enable Threshold	—	0.5	—	1.2	V	Turn-on
Enable Hysteresis	—	—	35	—	mV	—
Enable Input Current	—	—	0.1	2	μA	—
Overtemperature Shutdown	T_{SHD}	—	165	—	$^\circ\text{C}$	—
Overtemperature Shutdown Hysteresis	—	—	20	—	$^\circ\text{C}$	—

TEMPERATURE SPECIFICATIONS (Note 1)

Parameters	Sym.	Min.	Typ.	Max.	Units	Conditions
Temperature Ranges						
Junction Temperature Range	T_J	-40	—	+125	$^\circ\text{C}$	—
Storage Temperature Range	T_S	-65	—	+150	$^\circ\text{C}$	—
Package Thermal Resistances						
Thermal Resistance DFN 2 mm x 2 mm	θ_{JA}	—	90	—	$^\circ\text{C/W}$	—

Note 1: The maximum allowable power dissipation is a function of ambient temperature, the maximum allowable junction temperature and the thermal resistance from junction to air (i.e., T_A , T_J , θ_{JA}). Exceeding the maximum allowable power dissipation will cause the device operating junction temperature to exceed the maximum $+125^\circ\text{C}$ rating. Sustained junction temperatures above $+125^\circ\text{C}$ can impact the device reliability.

2.0 TYPICAL PERFORMANCE CURVES

Note: The graphs and tables provided following this note are a statistical summary based on a limited number of samples and are provided for informational purposes only. The performance characteristics listed herein are not tested or guaranteed. In some graphs or tables, the data presented may be outside the specified operating range (e.g., outside specified power supply range) and therefore outside the warranted range.

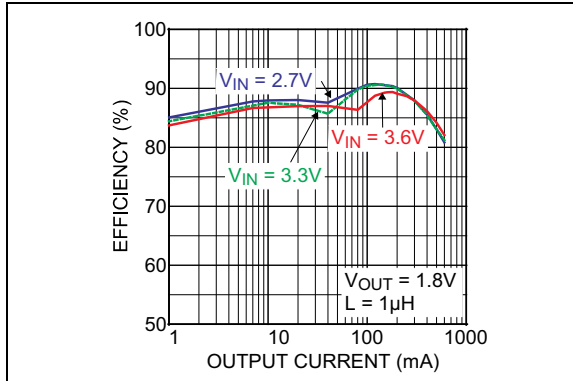

FIGURE 2-1: Efficiency ($V_{OUT} = 1.8V$).

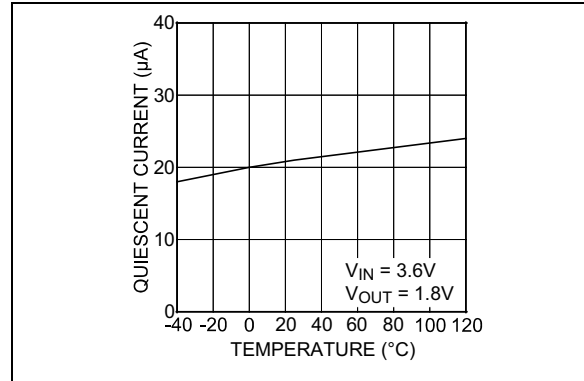

FIGURE 2-4: Quiescent Current vs. Temperature.

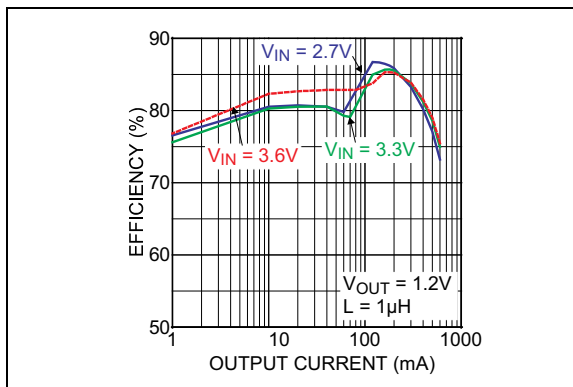

FIGURE 2-2: Efficiency ($V_{OUT} = 1.2V$).

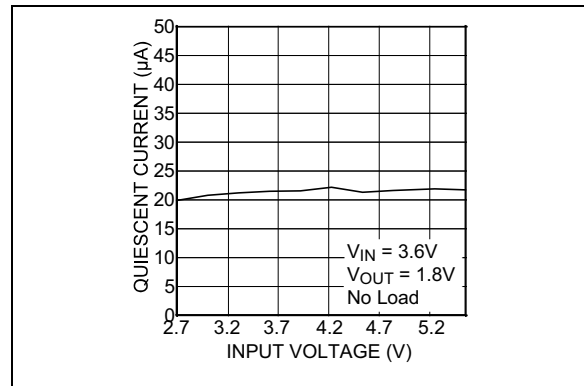

FIGURE 2-5: Quiescent Current vs. Input Voltage.

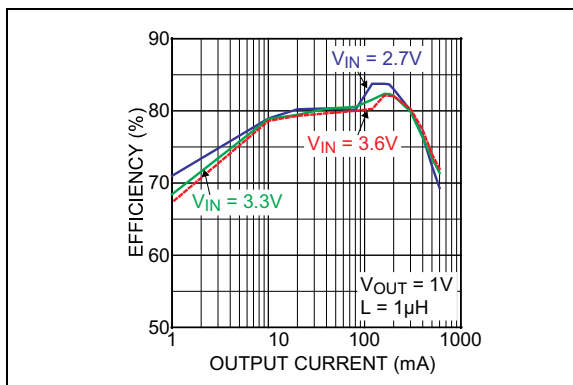

FIGURE 2-3: Efficiency ($V_{OUT} = 1V$).

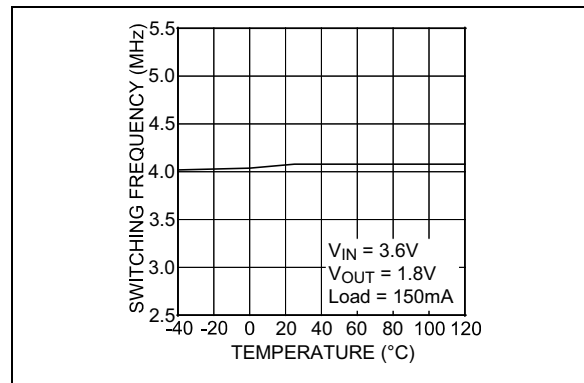

FIGURE 2-6: Switching Frequency vs. Temperature.

MIC23051

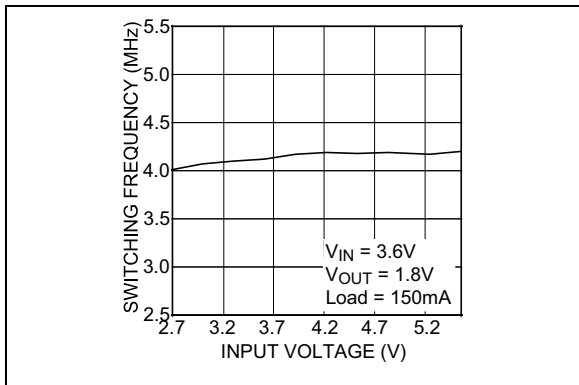

FIGURE 2-7: Switching Frequency vs. Input Voltage.

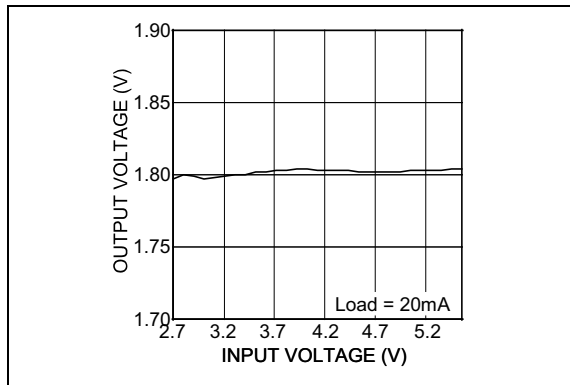

FIGURE 2-10: Output Voltage vs. Input Voltage.

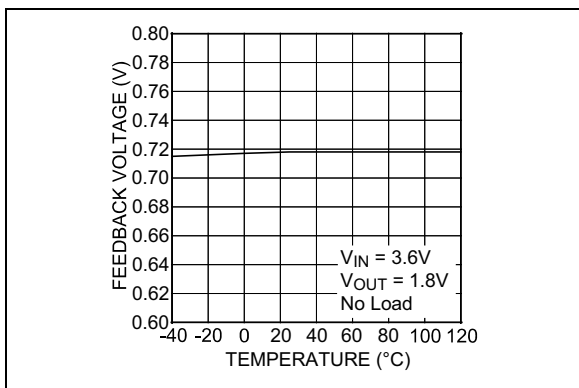

FIGURE 2-8: Feedback Voltage vs. Temperature.

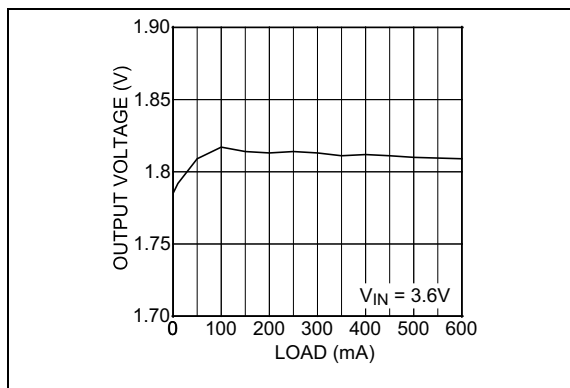

FIGURE 2-11: Output Voltage vs. Load.

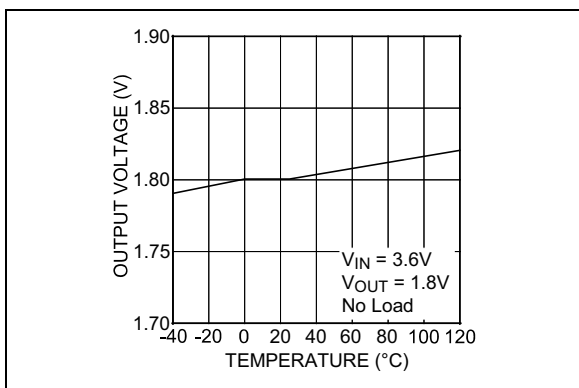

FIGURE 2-9: Output Voltage vs. Temperature.

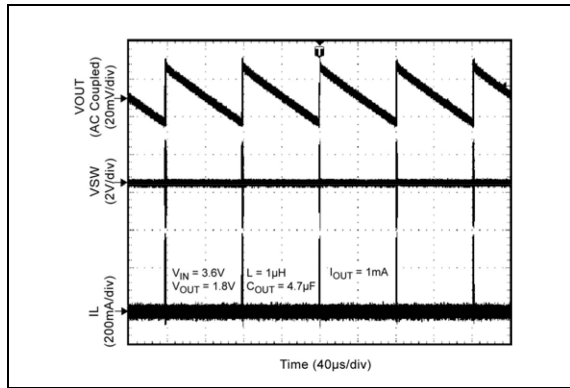
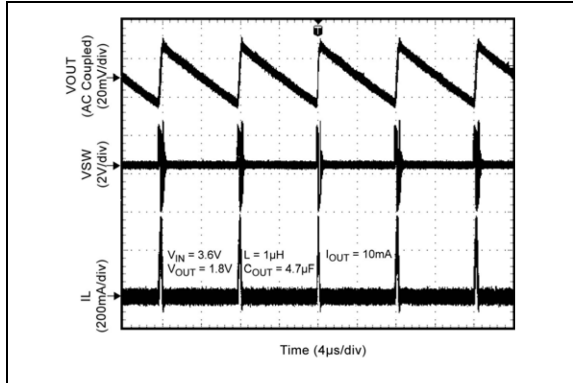
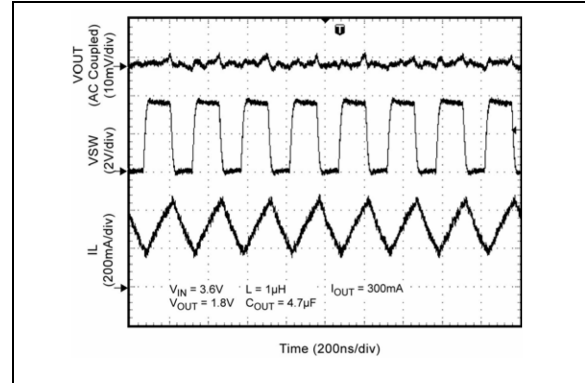
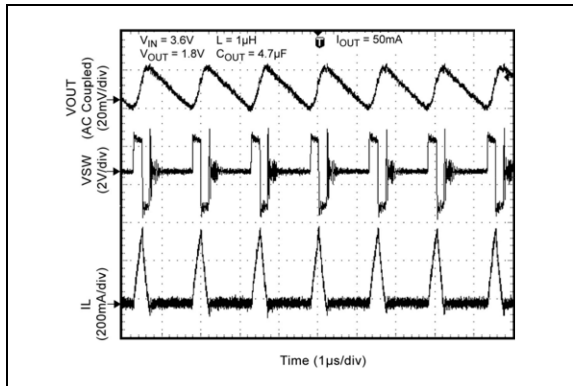
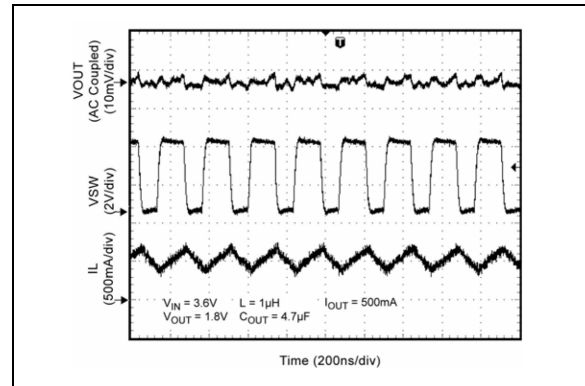
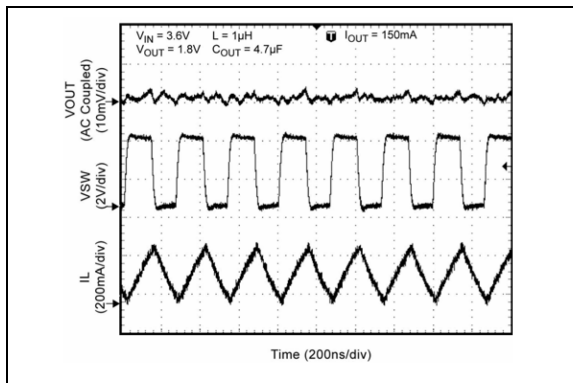
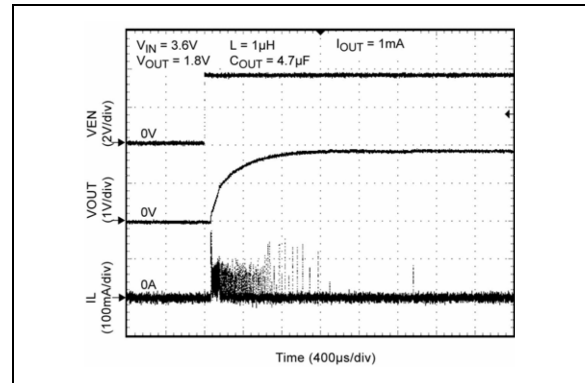

FIGURE 2-12: Switching Waveform.

**FIGURE 2-13:** Switching Waveform.**FIGURE 2-16:** Switching Waveform.**FIGURE 2-14:** Switching Waveform.**FIGURE 2-17:** Switching Waveform.**FIGURE 2-15:** Switching Waveform.**FIGURE 2-18:** Start-Up Waveform.

MIC23051

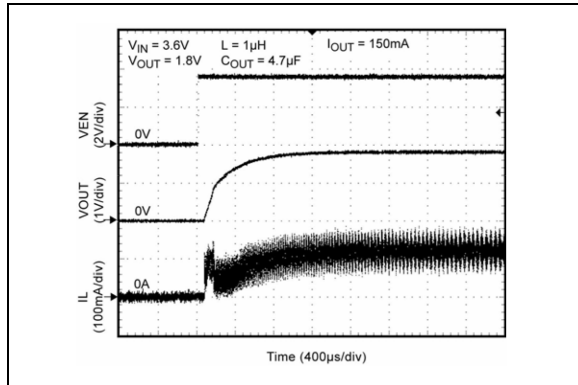

FIGURE 2-19: Start-Up Waveform.

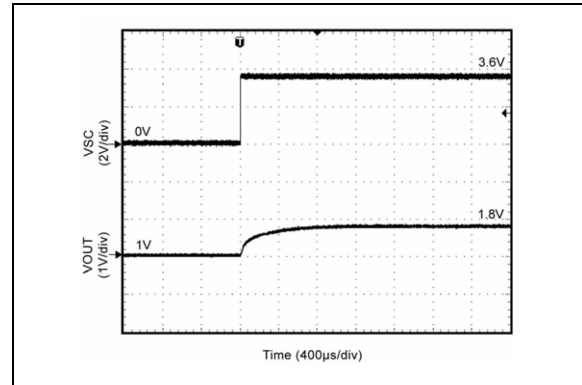

FIGURE 2-22: Output Transition Time.

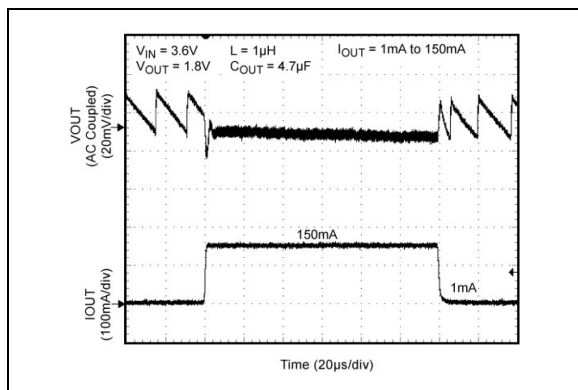

FIGURE 2-20: Load Transient.

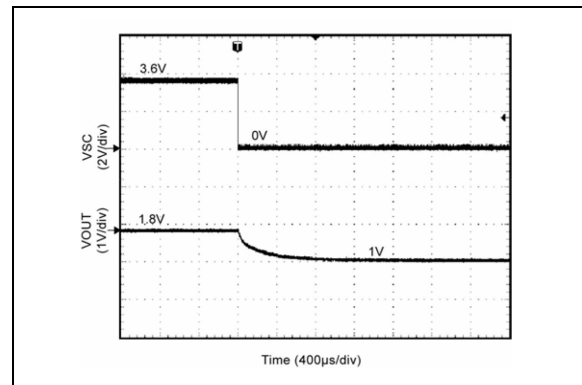

FIGURE 2-23: Output Transition Time.

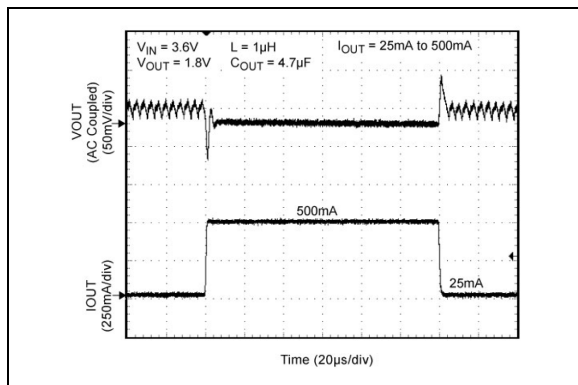

FIGURE 2-21: Load Transient.

3.0 PIN DESCRIPTIONS

The descriptions of the pins are listed in [Table](#) .

PIN FUNCTION TABLE

Pin Number	Pin Name	Description
1	SW	Switch (Output): Internal power MOSFET output switches.
2	EN	Enable (Input). Logic low will shut down the device, reducing the quiescent current to less than 4 μ A. Do not leave floating.
3	VSC	Voltage scaling pin (input): A low on this pin will scale the output voltage down to specified level. Do not leave floating.
4	SNS	Connect to VOUT to sense output voltage.
5	CFF	Feed Forward Capacitor. Connect a 560 pF capacitor.
6	AGND	Analog Ground.
7	VIN	Supply Voltage (Input): Requires bypass capacitor to GND.
8	PGND	Power ground.
—	EP	Exposed thermal pad.

Detailed Description

3.1 VIN

VIN provides power to the MOSFETs for the switch mode regulator section and to the analog supply circuitry. Due to the high switching speeds, a 2.2 μ F or greater capacitor is recommended close to VIN and the power ground (PGND) pin for bypassing.

3.2 EN

The enable pin (EN) controls the on and off state of the device. A logic high on the enable pin activates the regulator, while a logic low deactivates it. MIC23051 features built-in soft-start circuitry that reduces inrush current and prevents the output voltage from overshooting at start up. Do not leave floating.

3.3 SW

The switch (SW) pin connects directly to the inductor and provides the switching current necessary to operate in PWM mode. Due to the high speed switching on this pin, the switch node should be routed away from sensitive nodes such as the CFF pin.

3.4 SNS

The SNS pin should be connected to the output of the converter. Because this is a sensitive pin, it should be routed away from the SW node.

3.5 CFF

The CFF pin is connected to the SNS pin of MIC23051 with a feed-forward capacitor of 560 pF. The CFF pin itself is compared with the internal reference voltage (V_{REF}) of the device and provides the control path to

control the output. V_{REF} is equal to 0.72V. The CFF pin is sensitive to noise and should be placed away from the SW pin.

3.6 VSC

The voltage scaling pin (VSC) is used to switch between two different voltage levels. A logic high on the VSC pin will set the output voltage to the higher voltage. A logic low on the VSC pin will set the output voltage to the lower voltage. Do not leave floating.

3.7 PGND

Power ground (PGND) is the ground path for the high current PWM mode. The current loop for the power ground should be as small as possible and separate from the Signal ground (AGND) loop.

3.8 AGND

Signal ground (AGND) is the ground path for the biasing and control circuitry. The current loop for the signal ground should be separate from the Power ground (PGND) loop.

3.9 EP

Exposed Pad. Connect to ground plane with vias to ensure good thermal properties.

MIC23051

4.0 APPLICATIONS INFORMATION

4.1 Input Capacitor

A minimum of 2.2 μF ceramic capacitor should be placed close to the VIN pin and PGND pin for bypassing. X5R or X7R dielectrics are recommended for the input capacitor. Y5V dielectrics, aside from losing most of their capacitance over temperature, they also become resistive at high frequencies. This reduces their ability to filter out high frequency noise.

4.2 Output Capacitor

The MIC23051 was designed for use with a 2.2 μF or greater ceramic output capacitor. A low equivalent series resistance (ESR) ceramic output capacitor either X7R or X5R is recommended. Y5V and Z5U dielectric capacitors, aside from the undesirable effect of their wide variation in capacitance over temperature, become resistive at high frequencies.

4.3 Inductor Selection

Inductor selection will be determined by the following (not necessarily in the order of importance);

- Inductance
- Rated Current Value
- Size Requirements
- DC Resistance (DCR)

The MIC23051 was designed for use with an inductance range from 0.47 μH to 2.2 μH . Typically, a 1 μH inductor is recommended for a balance of transient response, efficiency and output ripple. For faster transient response, a 0.47 μH inductor may be used. For lower output ripple, a 2.2 μH is recommended.

Maximum current ratings of the inductor are generally given in two methods: permissible DC current and saturation current. Permissible DC current can be rated either for a 40°C temperature rise or a 10% to 20% loss in inductance. Ensure the inductor selected can handle the maximum operating current. When saturation current is specified, make sure that there is enough margin so that the peak current does not cause the inductor to saturate. Peak current can be calculated as follows:

EQUATION 4-1:

$$I_{PEAK} = \left[I_{OUT} + V_{OUT} \left(\frac{1 - V_{OUT}/V_{IN}}{2 \times f \times L} \right) \right]$$

As shown in Equation 4-1, the peak inductor current is inversely proportional to the switching frequency and the inductance; the lower the switching frequency or the inductance, the higher the peak current. As input voltage increases, the peak current also increases.

The size of the inductor depends on the requirements of the application. DC resistance (DCR) is also important. While DCR is inversely proportional to size, DCR can represent a significant efficiency loss. Refer to Section 4.5 “Efficiency Considerations”.

4.4 Compensation

The MIC23051 is designed to be stable with a 0.47 μH to 2.2 μH inductor with a minimum of 2.2 μF ceramic (X5R) output capacitor.

4.5 Efficiency Considerations

Efficiency is defined as the amount of useful output power, divided by the amount of power supplied.

EQUATION 4-2:

$$\eta = \left(\frac{V_{OUT} \times I_{OUT}}{V_{IN} \times I_{IN}} \right) \times 100$$

Maintaining high efficiency serves two purposes. It reduces power dissipation in the power supply, reducing the need for heat sinks and thermal design considerations and it reduces consumption of current for battery powered applications. Reduced current draw from a battery increases the devices operating time which is critical in hand held devices.

There are two types of losses in switching converters; DC losses and switching losses. DC losses are simply the power dissipation of I^2R . Power is dissipated in the high-side switch during the on cycle. Power loss is equal to the high-side MOSFET $R_{DS(ON)}$ multiplied by the switch current squared. During the off cycle, the low-side N-channel MOSFET conducts, also dissipating power. Device operating current also reduces efficiency. The product of the quiescent (operating) current and the supply voltage represents another DC loss. The current required driving the gates on and off at a constant 4 MHz frequency and the switching transitions make up the switching losses.

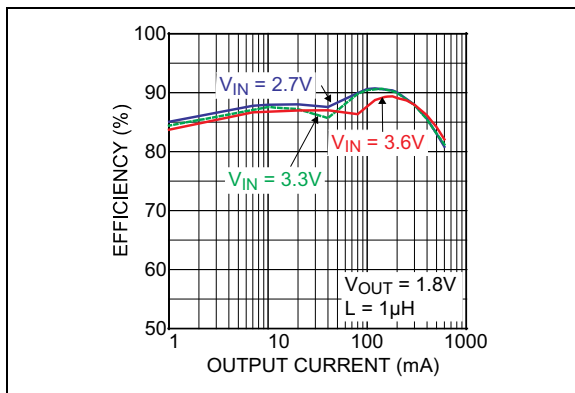

FIGURE 4-1: Efficiency $V_{OUT} = 1.8V$.

Figure 4-1 shows an efficiency curve. From no load to 100 mA, efficiency losses are dominated by quiescent current losses, gate drive and transition losses. By using HyperLight Load[®] mode, the MIC23051 is able to maintain high efficiency at low output currents.

Over 100 mA, efficiency loss is dominated by MOSFET $R_{DS(ON)}$ and inductor losses. Higher input supply voltages will increase the gate to source threshold on the internal MOSFETs, thereby reducing the internal $R_{DS(ON)}$. This improves efficiency by reducing DC losses in the device. All but the inductor losses are inherent to the device. In which case, inductor selection becomes increasingly critical in efficiency calculations. As the inductors are reduced in size, the DC resistance (DCR) can become quite significant.

The DCR losses can be calculated by using Equation 4-3:

EQUATION 4-3:

$$L_{PD} = I_{OUT}^2 \times DCR$$

From that, the loss in efficiency due to inductor resistance can be calculated by using Equation 4-4:

EQUATION 4-4:

$$EfficiencyLoss = \left[1 - \left(\frac{V_{OUT} \times I_{OUT}}{V_{OUT} \times I_{OUT} + L_{PD}} \right) \right] \times 100$$

Efficiency loss due to DCR is minimal at light loads and gains significance as the load is increased. Inductor selection becomes a trade-off between efficiency and size in this case.

4.6 HyperLight Load[®] Mode

MIC23051 uses a minimum on-time and off-time proprietary control loop. When the output voltage falls below the regulation threshold, the error comparator begins a switching cycle that turns the PMOS on and keeps it on for the duration of the minimum on-time. This increases the output voltage. If the output voltage is over the regulation threshold, then the error comparator turns the PMOS off for a minimum off-time until the output drops below the threshold. The NMOS acts as an ideal rectifier that conducts when the PMOS is off. Using a NMOS switch instead of a diode allows for lower voltage drop across the switching device when it is on. The asynchronous switching combination between the PMOS and the NMOS allows the control loop to work in discontinuous mode for light load operations. In discontinuous mode, the MIC23051 works in pulse frequency modulation (PFM) to regulate the output. As the output current increases, the off-time decreases, thus provides more energy to the output. This switching scheme improves the efficiency of MIC23051 during light load currents by only switching when it is needed. As the load current increases, the MIC23051 goes into continuous conduction mode (CCM) and switches at a frequency centered at 4 MHz. The equation to calculate the load when the MIC23051 goes into continuous conduction mode may be approximated by the following Equation 4-5:

EQUATION 4-5:

$$I_{LOAD} > \frac{(V_{IN} - V_{OUT}) \times D}{2 \times L \times f}$$

MIC23051

5.0 PACKAGING INFORMATION

5.1 Package Marking Information

8-Lead DFN*

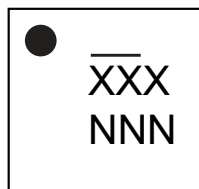

Example

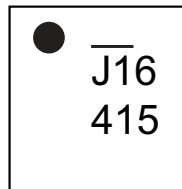
TABLE 5-1: MIC23051 PACKAGE MARKING CODES

Part Number	Voltage Scaled to with V_{SC} Low	Output Voltage	Marking Code
MIC23051-CGYML	1.0V	1.8V	\overline{JCG}
MIC23051-C4YML	1.0V	1.2V	$\overline{JC4}$
MIC23051-16YML	1.15V	1.40V	$\overline{J16}$
MIC23051-945YML	0.95V	1.25V	$\overline{945}$

Note: Other output voltage combinations (0.72 to 3.3V) available, contact Microchip Marketing for details.

<p>Legend: XX...X Product code or customer-specific information Y Year code (last digit of calendar year) YY Year code (last 2 digits of calendar year) WW Week code (week of January 1 is week '01') NNN Alphanumeric traceability code (e3) Pb-free JEDEC® designator for Matte Tin (Sn) * This package is Pb-free. The Pb-free JEDEC designator ((e3)) can be found on the outer packaging for this package.</p> <p>●, ▲, ▼ Pin one index is identified by a dot, delta up, or delta down (triangle mark).</p>
<p>Note: In the event the full Microchip part number cannot be marked on one line, it will be carried over to the next line, thus limiting the number of available characters for customer-specific information. Package may or may not include the corporate logo.</p> <p>Underbar (¯) and/or Overbar (˘) symbol may not be to scale.</p>

8-Lead DFN 2 mm x 2 mm Package Outline and Recommended Land Pattern**TITLE**

8 LEAD DFN 2x2mm PACKAGE OUTLINE & RECOMMENDED LAND PATTERN

DRAWING #	DFN22-8LD-PL-1	UNIT	MM
-----------	----------------	------	----

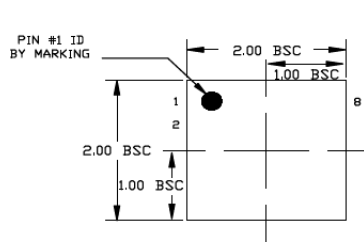

TOP VIEW
NOTE: 1, 2, 3

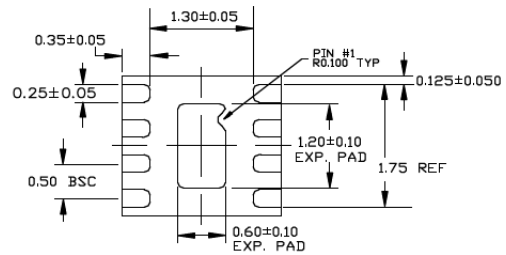

BOTTOM VIEW
NOTE: 1, 2, 3

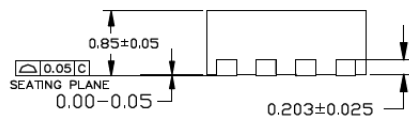

END VIEW
NOTE: 1, 2, 3

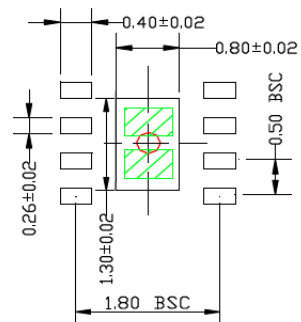

RECOMMENDED LAND PATTERN
NOTE: 4, 5

NOTE:

1. MAX PACKAGE WARPAGE IS 0.05 MM
2. MAX ALLOWABLE BURR IS 0.076MM IN ALL DIRECTIONS
3. PIN #1 IS ON TOP WILL BE LASER MARKED
4. RED CIRCLE IN LAND PATTERN INDICATE THERMAL VIA. SIZE SHOULD BE 0.30-0.35MM IN DIAMETER AND SHOULD BE CONNECTED TO GND FOR MAX THERMAL PERFORMANCE
5. GREEN RECTANGLES (SHADED AREA) INDICATE SOLDER STENCIL OPENING ON EXPOSED PAD AREA. SIZE SHOULD BE 0.60x0.40 MM IN SIZE, 0.20 MM SPACING.

Note: For the most current package drawings, please see the Microchip Packaging Specification located at <http://www.microchip.com/packaging>.

MIC23051

NOTES:

APPENDIX A: REVISION HISTORY

Revision A (December 2020)

- Converted Micrel document MIC23051 to Microchip data sheet DS20006471A.
- Minor text changes throughout.

MIC23051

NOTES:

PRODUCT IDENTIFICATION SYSTEM

To order or obtain information, e.g., on pricing or delivery, contact your local Microchip representative or sales office.

<u>PART NO.</u>	<u>-XX</u>	<u>X</u>	<u>XX</u>	<u>-XX</u>
Device	Output Voltage	Junction Temperature Range	Package Option	Media Type
Device:	MIC23051: 4 MHz PWM Buck Regulator with HyperLight Load® and Voltage Scaling			
Output Voltage:	-16 = 1.15V (V_{SC} Low), 1.4V (V_{SC} High) -945 = 0.95V (V_{SC} Low), 1.25V (V_{SC} High) -CG = 1.0V (V_{SC} Low), 1.8V (V_{SC} High) -C4 = 1.0V (V_{SC} Low), 1.2V (V_{SC} High)			
Junction Temperature Range:	Y = -40°C to +125°C, RoHS Compliant			
Package:	ML = 8-Lead 2 mm x 2 mm DFN			
Media Type:	TR = 5000/Reel			
Examples:				
a) MIC23051-16YML-TR: 4 MHz PWM Buck Regulator with HyperLight Load® and Voltage Scaling, 1.15V V_{SC} Low, 1.4V V_{SC} High, -40°C to +125°C Junction Temperature Range, RoHS Compliant, 8-Lead DFN Package, 5000/Reel				
b) MIC23051-945YML-TR: 4 MHz PWM Buck Regulator with HyperLight Load® and Voltage Scaling, 0.95V V_{SC} Low, 1.25V V_{SC} High, -40°C to +125°C Junction Temperature Range, RoHS Compliant, 8-Lead DFN Package, 5000/Reel				
c) MIC230510-CGYML-TR: 4 MHz PWM Buck Regulator with HyperLight Load® and Voltage Scaling, 1.0V V_{SC} Low, 1.8V V_{SC} High, -40°C to +125°C Junction Temperature Range, RoHS Compliant, 8-Lead DFN Package, 5000/Reel				
d) MIC23051-C4YML-TR: 4 MHz PWM Buck Regulator with HyperLight Load® and Voltage Scaling, 1.0V V_{SC} Low, 1.2V V_{SC} High, -40°C to +125°C Junction Temperature Range, RoHS Compliant, 8-Lead DFN Package, 5000/Reel				
Note 1: Tape and Reel identifier only appears in the catalog part number description. This identifier is used for ordering purposes and is not printed on the device package. Check with your Microchip Sales Office for package availability with the Tape and Reel option.				

MIC23051

NOTES:

Note the following details of the code protection feature on Microchip devices:

- Microchip products meet the specifications contained in their particular Microchip Data Sheet.
- Microchip believes that its family of products is secure when used in the intended manner and under normal conditions.
- There are dishonest and possibly illegal methods being used in attempts to breach the code protection features of the Microchip devices. We believe that these methods require using the Microchip products in a manner outside the operating specifications contained in Microchip's Data Sheets. Attempts to breach these code protection features, most likely, cannot be accomplished without violating Microchip's intellectual property rights.
- Microchip is willing to work with any customer who is concerned about the integrity of its code.
- Neither Microchip nor any other semiconductor manufacturer can guarantee the security of its code. Code protection does not mean that we are guaranteeing the product is "unbreakable." Code protection is constantly evolving. We at Microchip are committed to continuously improving the code protection features of our products. Attempts to break Microchip's code protection feature may be a violation of the Digital Millennium Copyright Act. If such acts allow unauthorized access to your software or other copyrighted work, you may have a right to sue for relief under that Act.

Information contained in this publication is provided for the sole purpose of designing with and using Microchip products. Information regarding device applications and the like is provided only for your convenience and may be superseded by updates. It is your responsibility to ensure that your application meets with your specifications.

THIS INFORMATION IS PROVIDED BY MICROCHIP "AS IS". MICROCHIP MAKES NO REPRESENTATIONS OR WARRANTIES OF ANY KIND WHETHER EXPRESS OR IMPLIED, WRITTEN OR ORAL, STATUTORY OR OTHERWISE, RELATED TO THE INFORMATION INCLUDING BUT NOT LIMITED TO ANY IMPLIED WARRANTIES OF NON-INFRINGEMENT, MERCHANTABILITY, AND FITNESS FOR A PARTICULAR PURPOSE OR WARRANTIES RELATED TO ITS CONDITION, QUALITY, OR PERFORMANCE.

IN NO EVENT WILL MICROCHIP BE LIABLE FOR ANY INDIRECT, SPECIAL, PUNITIVE, INCIDENTAL OR CONSEQUENTIAL LOSS, DAMAGE, COST OR EXPENSE OF ANY KIND WHATSOEVER RELATED TO THE INFORMATION OR ITS USE, HOWEVER CAUSED, EVEN IF MICROCHIP HAS BEEN ADVISED OF THE POSSIBILITY OR THE DAMAGES ARE FORESEEABLE. TO THE FULLEST EXTENT ALLOWED BY LAW, MICROCHIP'S TOTAL LIABILITY ON ALL CLAIMS IN ANY WAY RELATED TO THE INFORMATION OR ITS USE WILL NOT EXCEED THE AMOUNT OF FEES, IF ANY, THAT YOU HAVE PAID DIRECTLY TO MICROCHIP FOR THE INFORMATION. Use of Microchip devices in life support and/or safety applications is entirely at the buyer's risk, and the buyer agrees to defend, indemnify and hold harmless Microchip from any and all damages, claims, suits, or expenses resulting from such use. No licenses are conveyed, implicitly or otherwise, under any Microchip intellectual property rights unless otherwise stated.

Trademarks

The Microchip name and logo, the Microchip logo, Adaptec, AnyRate, AVR, AVR logo, AVR Freaks, BesTime, BitCloud, chipKIT, chipKIT logo, CryptoMemory, CryptoRF, dsPIC, FlashFlex, flexPWR, HELDO, IGL00, JukeBlox, KeeLoq, Klear, LANCheck, LinkMD, maXStylus, maXTouch, MediaLB, megaAVR, Microsemi, Microsemi logo, MOST, MOST logo, MPLAB, OptoLyzr, PackeTime, PIC, picoPower, PICSTART, PIC32 logo, PolarFire, Prochip Designer, QTouch, SAM-BA, SenGenuity, SpyNIC, SST, SST Logo, SuperFlash, Symmetricom, SyncServer, Tachyon, TimeSource, tinyAVR, UNI/O, Vectron, and XMEGA are registered trademarks of Microchip Technology Incorporated in the U.S.A. and other countries.

AgileSwitch, APT, ClockWorks, The Embedded Control Solutions Company, EtherSynch, FlashTec, Hyper Speed Control, HyperLight Load, IntelliMOS, Libero, motorBench, mTouch, Powermite 3, Precision Edge, ProASIC, ProASIC Plus, ProASIC Plus logo, Quiet-Wire, SmartFusion, SyncWorld, Temux, TimeCesium, TimeHub, TimePictra, TimeProvider, WinPath, and ZL are registered trademarks of Microchip Technology Incorporated in the U.S.A.

Adjacent Key Suppression, AKS, Analog-for-the-Digital Age, Any Capacitor, AnyIn, AnyOut, Augmented Switching, BlueSky, BodyCom, CodeGuard, CryptoAuthentication, CryptoAutomotive, CryptoCompanion, CryptoController, dsPICDEM, dsPICDEM.net, Dynamic Average Matching, DAM, ECAN, Espresso T1S, EtherGREEN, IdealBridge, In-Circuit Serial Programming, ICSP, INICnet, Intelligent Paralleling, Inter-Chip Connectivity, JitterBlocker, maxCrypto, maxView, memBrain, Mindi, MiWi, MPASM, MPF, MPLAB Certified logo, MPLIB, MPLINK, MultiTRAK, NetDetach, Omniscient Code Generation, PICDEM, PICDEM.net, PICkit, PICtail, PowerSmart, PureSilicon, QMatrix, REAL ICE, Ripple Blocker, RTAX, RTG4, SAM-ICE, Serial Quad I/O, simpleMAP, SimpliPHY, SmartBuffer, SMART-I.S., storClad, SQI, SuperSwitcher, SuperSwitcher II, Switchtec, SynchroPHY, Total Endurance, TSHARC, USBCheck, VariSense, VectorBlox, VeriPHY, ViewSpan, WiperLock, XpressConnect, and ZENA are trademarks of Microchip Technology Incorporated in the U.S.A. and other countries.

SQTP is a service mark of Microchip Technology Incorporated in the U.S.A.

The Adaptec logo, Frequency on Demand, Silicon Storage Technology, and Symmcom are registered trademarks of Microchip Technology Inc. in other countries.

GestIC is a registered trademark of Microchip Technology Germany II GmbH & Co. KG, a subsidiary of Microchip Technology Inc., in other countries.

All other trademarks mentioned herein are property of their respective companies.

© 2020, Microchip Technology Incorporated, All Rights Reserved.

ISBN: 978-1-5224-7406-7

For information regarding Microchip's Quality Management Systems, please visit www.microchip.com/quality.



MICROCHIP

Worldwide Sales and Service

AMERICAS

Corporate Office
2355 West Chandler Blvd.
Chandler, AZ 85224-6199
Tel: 480-792-7200
Fax: 480-792-7277
Technical Support:
<http://www.microchip.com/support>
Web Address:
www.microchip.com

Atlanta
Duluth, GA
Tel: 678-957-9614
Fax: 678-957-1455

Austin, TX
Tel: 512-257-3370

Boston
Westborough, MA
Tel: 774-760-0087
Fax: 774-760-0088

Chicago
Itasca, IL
Tel: 630-285-0071
Fax: 630-285-0075

Dallas
Addison, TX
Tel: 972-818-7423
Fax: 972-818-2924

Detroit
Novi, MI
Tel: 248-848-4000

Houston, TX
Tel: 281-894-5983

Indianapolis
Noblesville, IN
Tel: 317-773-8323
Fax: 317-773-5453
Tel: 317-536-2380

Los Angeles
Mission Viejo, CA
Tel: 949-462-9523
Fax: 949-462-9608
Tel: 951-273-7800

Raleigh, NC
Tel: 919-844-7510

New York, NY
Tel: 631-435-6000

San Jose, CA
Tel: 408-735-9110
Tel: 408-436-4270

Canada - Toronto
Tel: 905-695-1980
Fax: 905-695-2078

ASIA/PACIFIC

Australia - Sydney
Tel: 61-2-9868-6733

China - Beijing
Tel: 86-10-8569-7000

China - Chengdu
Tel: 86-28-8665-5511

China - Chongqing
Tel: 86-23-8980-9588

China - Dongguan
Tel: 86-769-8702-9880

China - Guangzhou
Tel: 86-20-8755-8029

China - Hangzhou
Tel: 86-571-8792-8115

China - Hong Kong SAR
Tel: 852-2943-5100

China - Nanjing
Tel: 86-25-8473-2460

China - Qingdao
Tel: 86-532-8502-7355

China - Shanghai
Tel: 86-21-3326-8000

China - Shenyang
Tel: 86-24-2334-2829

China - Shenzhen
Tel: 86-755-8864-2200

China - Suzhou
Tel: 86-186-6233-1526

China - Wuhan
Tel: 86-27-5980-5300

China - Xian
Tel: 86-29-8833-7252

China - Xiamen
Tel: 86-592-2388138

China - Zhuhai
Tel: 86-756-3210040

ASIA/PACIFIC

India - Bangalore
Tel: 91-80-3090-4444

India - New Delhi
Tel: 91-11-4160-8631

India - Pune
Tel: 91-20-4121-0141

Japan - Osaka
Tel: 81-6-6152-7160

Japan - Tokyo
Tel: 81-3-6880-3770

Korea - Daegu
Tel: 82-53-744-4301

Korea - Seoul
Tel: 82-2-554-7200

Malaysia - Kuala Lumpur
Tel: 60-3-7651-7906

Malaysia - Penang
Tel: 60-4-227-8870

Philippines - Manila
Tel: 63-2-634-9065

Singapore
Tel: 65-6334-8870

Taiwan - Hsin Chu
Tel: 886-3-577-8366

Taiwan - Kaohsiung
Tel: 886-7-213-7830

Taiwan - Taipei
Tel: 886-2-2508-8600

Thailand - Bangkok
Tel: 66-2-694-1351

Vietnam - Ho Chi Minh
Tel: 84-28-5448-2100

EUROPE

Austria - Wels
Tel: 43-7242-2244-39
Fax: 43-7242-2244-393

Denmark - Copenhagen
Tel: 45-4485-5910
Fax: 45-4485-2829

Finland - Espoo
Tel: 358-9-4520-820

France - Paris
Tel: 33-1-69-53-63-20
Fax: 33-1-69-30-90-79

Germany - Garching
Tel: 49-8931-9700

Germany - Haan
Tel: 49-2129-3766400

Germany - Heilbronn
Tel: 49-7131-72400

Germany - Karlsruhe
Tel: 49-721-625370

Germany - Munich
Tel: 49-89-627-144-0
Fax: 49-89-627-144-44

Germany - Rosenheim
Tel: 49-8031-354-560

Israel - Ra'anana
Tel: 972-9-744-7705

Italy - Milan
Tel: 39-0331-742611
Fax: 39-0331-466781

Italy - Padova
Tel: 39-049-7625286

Netherlands - Drunen
Tel: 31-416-690399
Fax: 31-416-690340

Norway - Trondheim
Tel: 47-7288-4388

Poland - Warsaw
Tel: 48-22-3325737

Romania - Bucharest
Tel: 40-21-407-87-50

Spain - Madrid
Tel: 34-91-708-08-90
Fax: 34-91-708-08-91

Sweden - Gothenberg
Tel: 46-31-704-60-40

Sweden - Stockholm
Tel: 46-8-5090-4654

UK - Wokingham
Tel: 44-118-921-5800
Fax: 44-118-921-5820

OUR CERTIFICATE

DiGi provide top-quality products and perfect service for customer worldwide through standardization, technological innovation and continuous improvement. DiGi through third-party certification, we stricly control the quality of products and services. Welcome your RFQ to

Email: Info@DiGi-Electronics.com



Tel: +00 852-30501935

RFQ Email: Info@DiGi-Electronics.com

DiGi is a global authorized distributor of electronic components.