

# MIC2536-1YM Datasheet

[www.digi-electronics.com](http://www.digi-electronics.com)

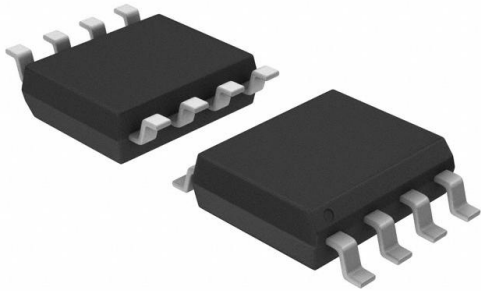

<https://www.DiGi-Electronics.com>

DiGi Electronics Part Number	MIC2536-1YM-DG
Manufacturer	<a href="#">Microchip Technology</a>
Manufacturer Product Number	MIC2536-1YM
Description	IC PWR SWITCH N-CHAN 1:2 8SOIC
Detailed Description	Power Switch/Driver 1:2 N-Channel 150mA 8-SOIC



Tel: +00 852-30501935

RFQ Email: [Info@DiGi-Electronics.com](mailto:Info@DiGi-Electronics.com)

DiGi is a global authorized distributor of electronic components.

## Purchase and inquiry

Manufacturer Product Number:

MIC2536-1YM

Series:

-

Switch Type:

USB Switch

Ratio - Input:Output:

1:2

Output Type:

N-Channel

Voltage - Load:

2.7V ~ 5.5V

Current - Output (Max):

150mA

Input Type:

Non-Inverting

Fault Protection:

Current Limiting (Fixed), Over Temperature, Reverse Current

Mounting Type:

Surface Mount

Package / Case:

8-SOIC (0.154", 3.90mm Width)

Manufacturer:

Microchip Technology

Product Status:

Active

Number of Outputs:

2

Output Configuration:

High Side

Interface:

On/Off

Voltage - Supply (Vcc/Vdd):

Not Required

Rds On (Typ):

400mOhm

Features:

Slew Rate Controlled, Status Flag

Operating Temperature:

-40°C ~ 85°C (TA)

Supplier Device Package:

8-SOIC

Base Product Number:

MIC2536

## Environmental & Export classification

RoHS Status:

ROHS3 Compliant

REACH Status:

REACH Unaffected

HTSUS:

8542.39.0001

Moisture Sensitivity Level (MSL):

1 (Unlimited)

ECCN:

EAR99





The Infinite Bandwidth Company™

## MIC2536

### Dual USB Power Distribution Switch

#### Final Information

### General Description

The MIC2536 is a cost-effective high-side power switch, with two independently controlled channels, optimized for bus-powered Universal Serial Bus (USB) applications. Few external components are necessary to satisfy USB requirements.

Each switch channel of the MIC2536 will supply up to 100mA as required for USB bus-powered downstream devices. Fault current is limited to typically 275mA by fast-acting current-limit circuitry which minimizes voltage droop on the upstream port during fault conditions. A flag output with transient filter indicates fault conditions to the local USB controller but will ignore short flag signals resulting from inrush current during hot plug-in events.

Soft start eliminates the momentary voltage droop on other ports that may occur when the switch is enabled in bus-powered applications. Additional features include thermal shutdown to prevent catastrophic switch failure from high-current loads and 3.3V and 5V logic compatible enable inputs.

The MIC2536 is available in active-high and active-low versions in 8-lead SOP and MSOP.

### Features

- Compliant to USB specifications
- 2.7V to 5.5V operating range
- 150mA minimum continuous load current per channel
- 400mΩ typical on-resistance
- Fast-acting short circuit protection with thermal shutdown
- Integrated filter eliminates false overcurrent flag assertions
- Individual open-drain fault flag pins with transient filter
- 3V/5V-compatible enable inputs
- Active-high (-1) and active-low (-2) versions
- Reverse-current blocking in off mode (no "body diode")
- Soft-start circuit
- 100μA maximum on-state supply current
- <1μA typical off-state supply current
- -40°C to 85°C operation

### Applications

- USB keyboard bus-powered hubs
- USB bus-powered docking stations
- Note Book PCs
- PDAs
- General purpose power distribution applications
- PC board hot swap
- Inrush current-limiting

### Typical Application

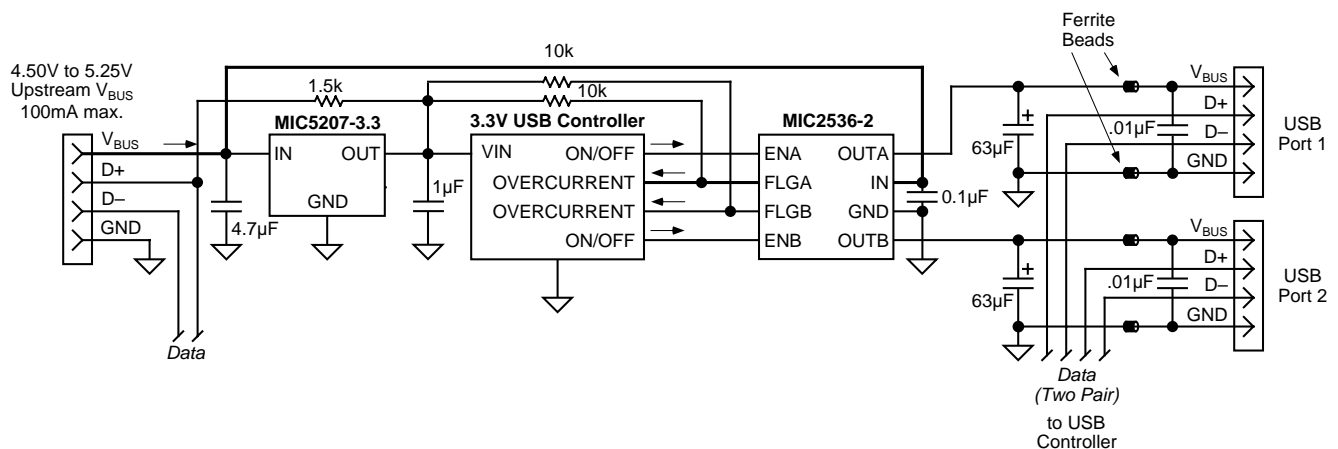

Typical Two-Port Bus-Powered Hub



UL Recognized Component

Micrel, Inc. • 1849 Fortune Drive • San Jose, CA 95131 • USA • tel + 1 (408) 944-0800 • fax + 1 (408) 944-0970 • <http://www.micrel.com>

## Ordering Information

Part Number	Enable	Temperature Range	Package
MIC2536-1BM	Active High	-40°C to +85°C	8-Lead SOP
MIC2536-2BM	Active Low	-40°C to +85°C	8-Lead SOP
MIC2536-1BMM	Active High	-40°C to +85°C	8-Lead MSOP
MIC2536-2BMM	Active Low	-40°C to +85°C	8-Lead MSOP

## Pin Configuration

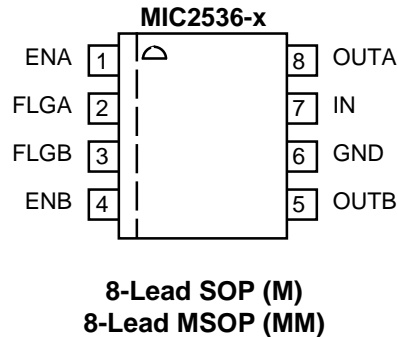

## Pin Description

Pin Number	Pin Name	Pin Function
1	ENA	Enable A (Input): Channel A control input. Active high (-1) or active low (-2) input.
2	FLGA	Flag A: (Output): Channel A open-drain fault flag output. Indicates overcurrent or thermal shutdown conditions. Overcurrent conditions must last longer than $t_D$ in order to assert FLG.
3	FLGB	Flag B (Output): Channel B open-drain fault flag output. Indicates overcurrent or thermal shutdown conditions. Overcurrent conditions must last longer than $t_D$ in order to assert FLG.
4	ENB	Enable B (Input): Channel B control input. Active high (-1) or active low (-2) input.
5	OUTB	Output B: Channel B switch output.
6	GND	Ground
7	IN	Positive Switch and Logic Supply Input
8	OUTA	Output A: Channel A switch output.

**Absolute Maximum Ratings (Note 1)**

Supply Voltage ( $V_{IN}$ )	+6V
Fault Flag Voltage ( $V_{FLG}$ )	+6V
Fault Flag Current ( $I_{FLG}$ )	25mA
Output Voltage ( $V_{OUT}$ )	+6V
Output Current ( $I_{OUT}$ )	Internally Limited
Control Input ( $V_{EN}$ )	-0.3V to $V_{IN}$ +2V
Storage Temperature ( $T_S$ )	-65°C to +150°C
Lead Temperature (Soldering 5 sec.)	260°C
ESD Rating, <b>Note 3</b>	1kV

**Operating Ratings (Note 2)**

Supply Voltage ( $V_{IN}$ )	+2.7V to +5.5V
Ambient Operating Temperature ( $T_A$ )	-40°C to +85°C
Thermal Resistance	
SOP ( $\theta_{JA}$ )	160°C/W
MSOP ( $\theta_{JA}$ )	206°C/W

**Electrical Characteristics**

$V_{IN} = +5V$ ;  $T_A = 25^\circ\text{C}$ , **bold** values indicate  $-40^\circ\text{C} \leq T_A \leq +85^\circ\text{C}$ ; unless noted

Parameter	Condition	Min	Typ	Max	Units
Supply Current	both switches off, OUTA-B = open, <b>Note 4</b>		0.75	5	$\mu\text{A}$
	both switches on, OUTA-B = open, <b>Note 4</b>		60	100	$\mu\text{A}$
Enable Input Threshold	low-to-high transition, <b>Note 4</b>		1.7	2.4	V
	high-to-low transition, <b>Note 4</b>	0.8	1.5		V
Enable Input Current	$V_{EN} = 0V$ to 5.5V		0.01	1	$\mu\text{A}$
Enable Input Capacitance	<b>Note 5</b>		1		pF
Switch Resistance	single switch, $I_{OUT} = 100\text{mA}$		400	<b>700</b>	m $\Omega$
Output Turn-On Delay, $t_{ON}$	$R_L = 50\Omega$ , $C_L = 1\mu\text{F}$		1.5		ms
Output Turn-On Rise Time, $t_R$	$R_L = 50\Omega$ , $C_L = 1\mu\text{F}$		1.4		ms
Output Turnoff Delay, $t_{OFF}$	$R_L = 50\Omega$ , $C_L = 1\mu\text{F}$		130		$\mu\text{s}$
Output Turnoff Fall Time, $t_F$	$R_L = 50\Omega$ , $C_L = 1\mu\text{F}$		115		$\mu\text{s}$
Output Leakage Current	each output (switch off)		1	10	$\mu\text{A}$
Current Limit Threshold	ramped load applied to enable output			<b>500</b>	mA
Short Circuit Current Limit	each output (enabled into load), $V_{OUT} = 0V$	150	275	<b>400</b>	mA
Current Limit Response	$V_{OUT} = 0V$ to $I_{OUT} = I_{LIMIT}$ (short applied to output), <b>Note 5</b>		10		$\mu\text{s}$
Flag Response Delay, $t_D$	$V_{IN} = 5V$ , apply $V_{OUT} = 0V$ until FLG low	5	13	20	ms
	$V_{IN} = 3.3V$ , apply $V_{OUT} = 0V$ until FLG low		13		ms
Overtemperature Shutdown Threshold	$T_J$ increasing, <b>Note 5</b>		135		$^\circ\text{C}$
	$T_J$ decreasing, <b>Note 5</b>		125		$^\circ\text{C}$
Error Flag Output Resistance	$V_{IN} = 5V$ , $I_L = 10\text{mA}$		10	20	$\Omega$
	$V_{IN} = 3.3V$ , $I_L = 10\text{mA}$		15	30	$\Omega$
Error Flag Off Current	$V_{FLAG} = 5V$		0.01	<b>1</b>	$\mu\text{A}$

**Note 1.** Exceeding the absolute maximum rating may damage the device.

**Note 2.** The device is not guaranteed to function outside its operating rating.

**Note 3.** Devices are ESD sensitive. Handling precautions recommended. Human body model, 1.5k $\Omega$  in series with 100pF.

**Note 4.** Off is  $\leq 0.8V$  and on is  $\geq 2.4V$  for the MIC2536-1. Off is  $\geq 2.4V$  and on is  $\leq 0.8V$  for the MIC2536-2. The enable input has approximately 200mV of hysteresis.

**Note 5.** Guaranteed by design. Not production tested.

## Test Circuit

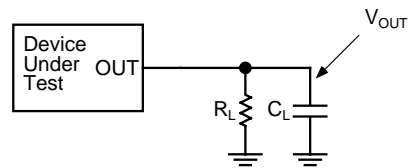

**Functional Characteristics Test Circuit**

## Timing Diagrams

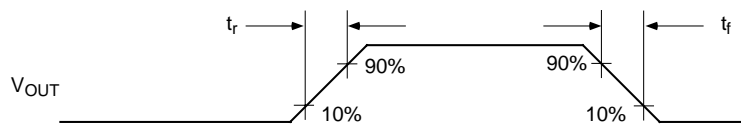

**Output Rise and Fall Times**

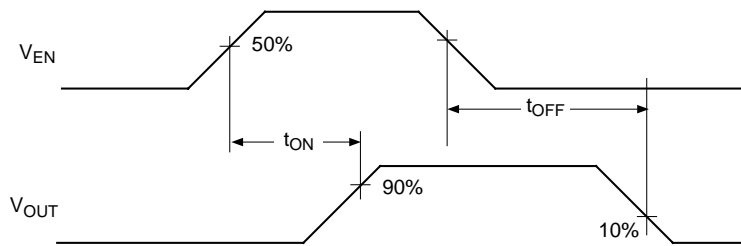

**Active-High Switch Delay Times (MIC2536-1)**

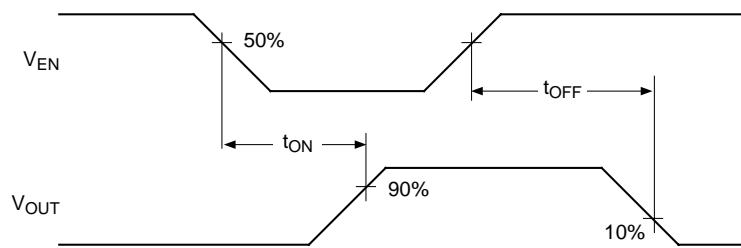

**Active-Low Switch Delay Times (MIC2536-2)**

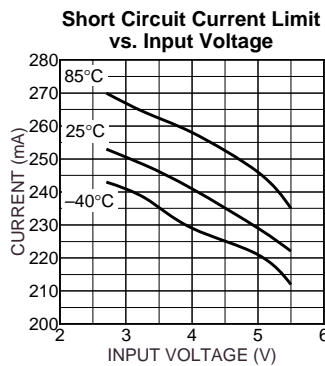
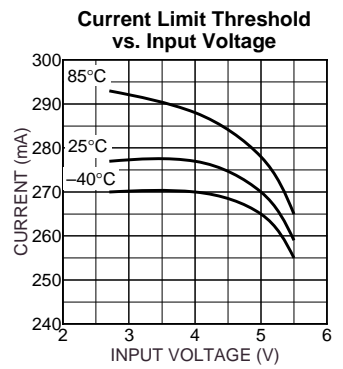
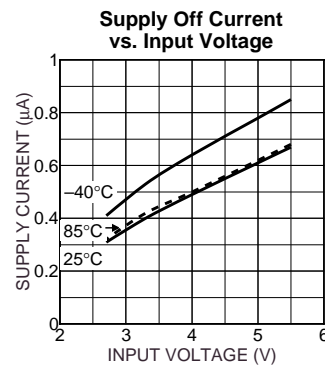
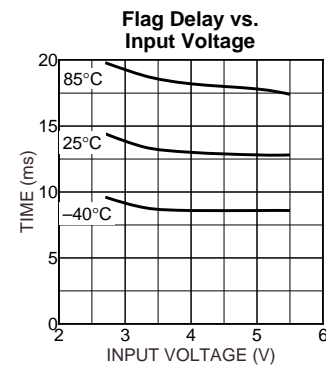
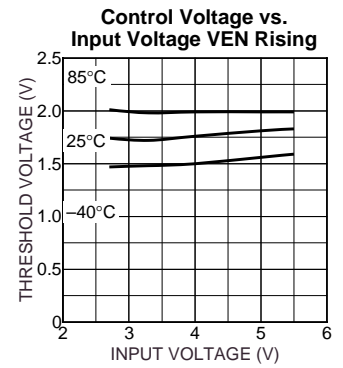
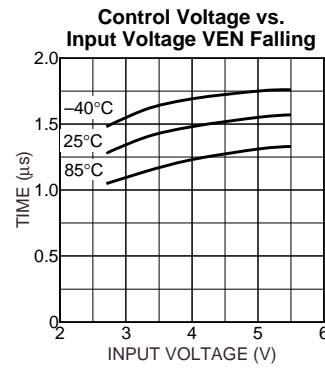
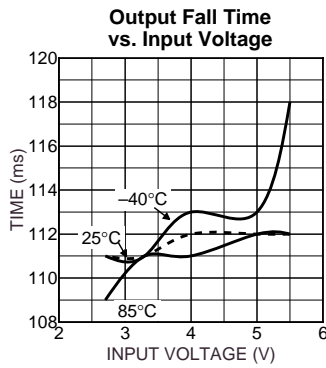
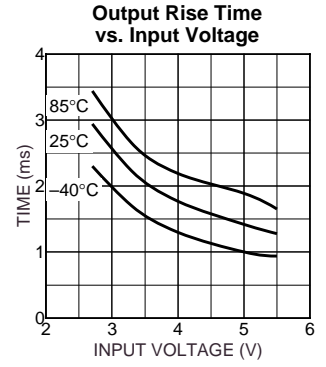
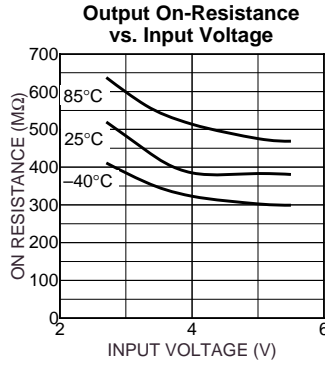
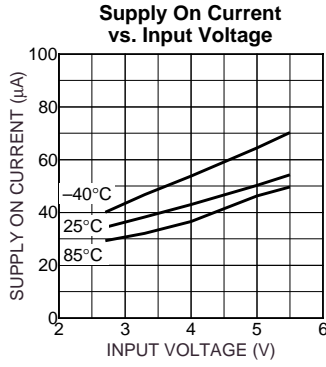

# Functional Characteristics

**Turn-On / Turnoff  
(MIC2536-1)**

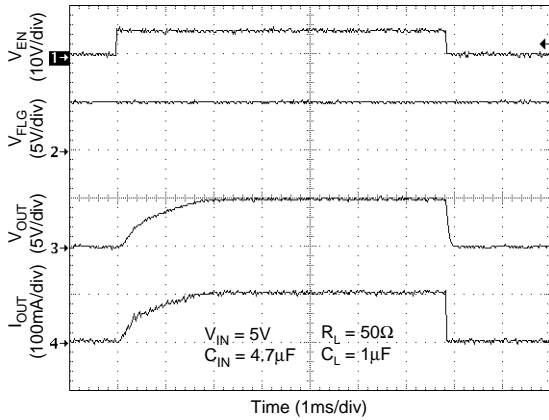

**Turn-On  
(MIC2536-1)**

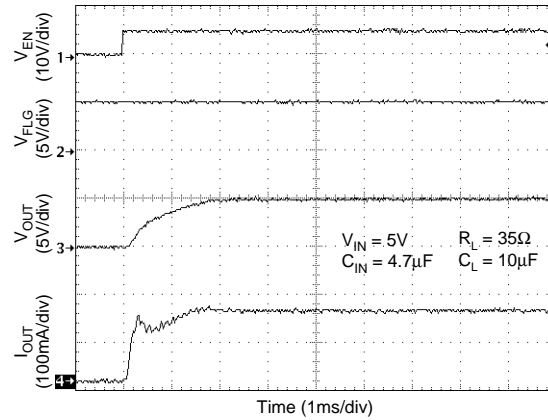

**Turnoff  
(MIC2536-1)**

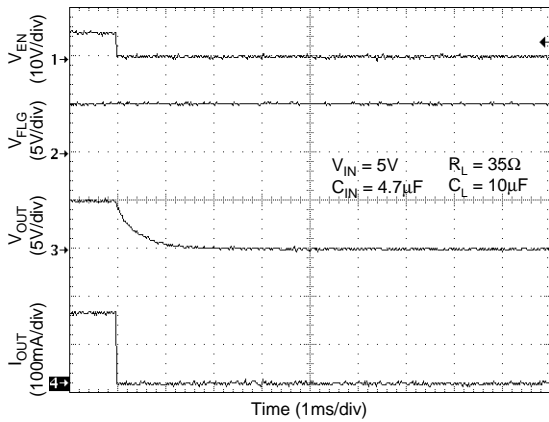

**Turn-On  
(MIC2536-1)**

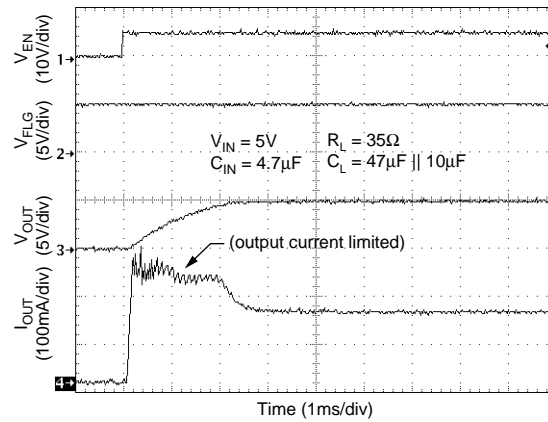

**Turnoff  
(MIC2536-1)**

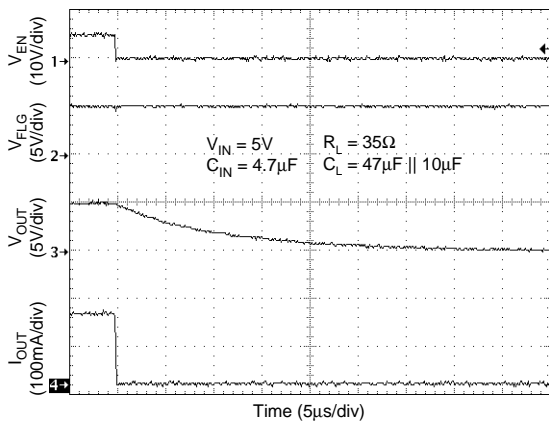

**Enabled Into Short Circuit  
(MIC2536-1)**

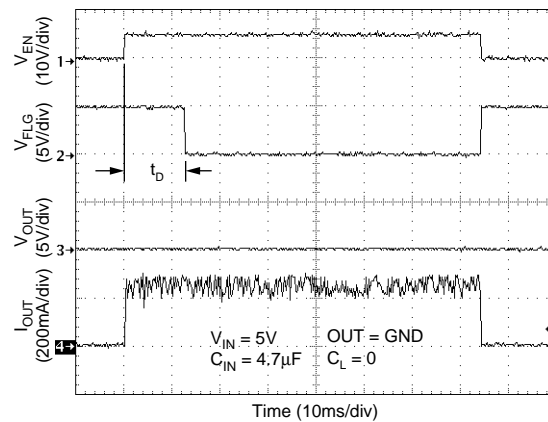



**Ramped Into Short Circuit  
(MIC2536-1)**

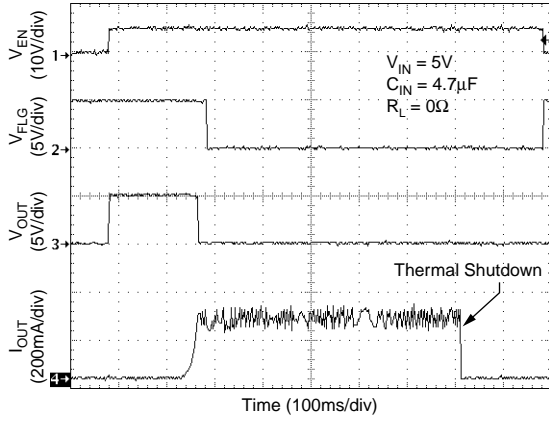

**Inrush Current  
(MIC2536-1)**

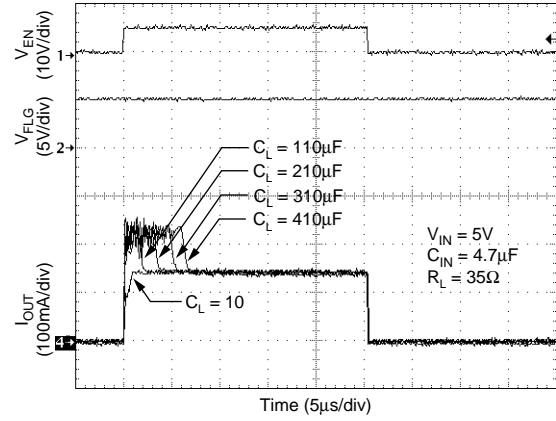

**Current-Loop Response  
(MIC2536-1)**

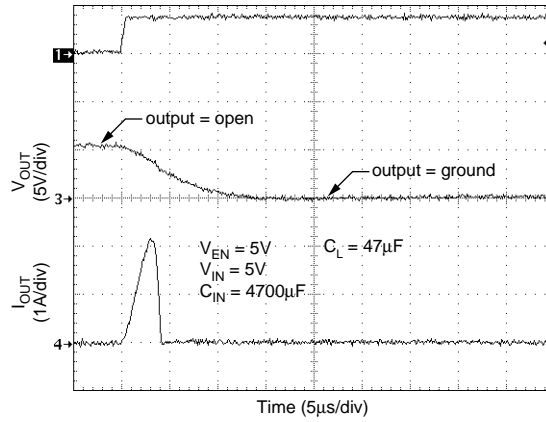

# Block Diagram

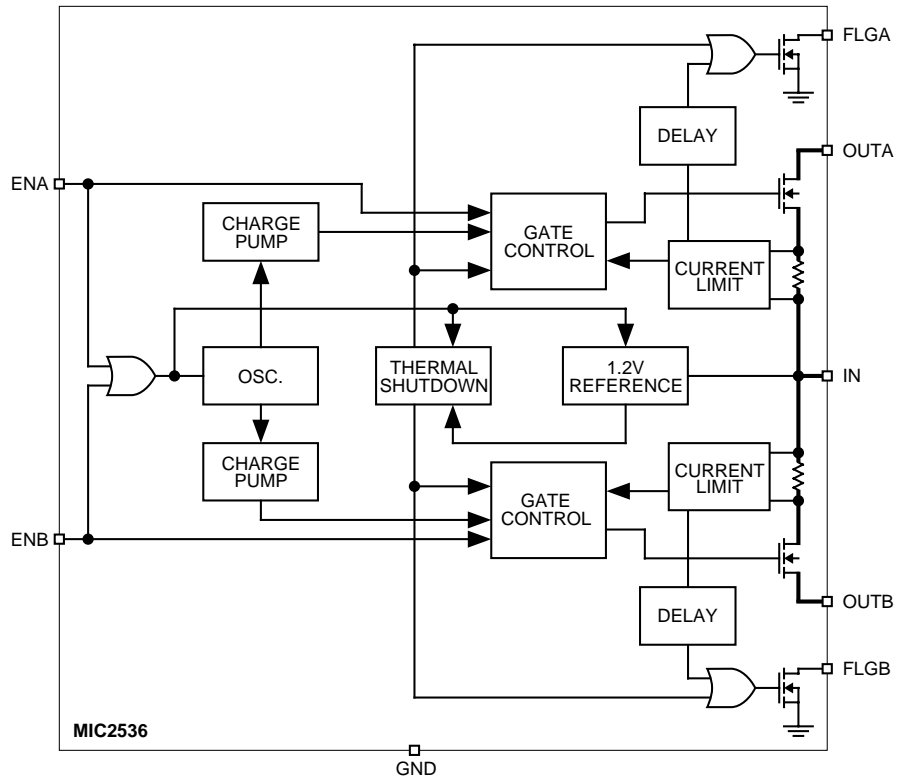

## Functional Description

The MIC2536-1 and MIC2536-2 are dual high-side switches with active-high and active-low enable inputs, respectively. Fault conditions turn off or inhibit turn-on of one or more of the output transistors, depending upon the type of fault, and activate the open-drain error flag transistors making them sink current to ground.

### Input and Output

IN (input) is the power supply connection to the logic circuitry and the drain of each output MOSFET. OUTx (output) is the source of each respective MOSFET. In a typical circuit, current flows through the switch from IN to OUTx toward the load. If  $V_{OUT}$  is greater than  $V_{IN}$ , current will flow from OUT to IN during an on-condition since the MOSFET is bidirectional when enabled.

The output MOSFET and driver circuitry are also designed to allow the MOSFET source to be externally forced to a higher voltage than the drain ( $V_{OUTx} > V_{IN}$ ) when the output is disabled. In this situation, the MIC2536 prevents reverse current flow.

### Thermal Shutdown

Each output MOSFET has its own thermal sensor. If either or both channels reach 135°C, affected channel(s) will be shut down and flag(s) asserted. 10°C of hysteresis prevents the switches from turning on until the die temperature drops to 125°C. Overtemperature detection functions only when at least one switch is enabled.

The MIC2536 will automatically reset its output when the die temperature cools to approximately 125°C. The MIC2536 output and FLG signal will continue to cycle on and off until the device is disabled or the fault is removed.

Depending on PCB layout, package, ambient temperature, etc., it may take several hundred milliseconds from the occurrence of the fault to the output MOSFET being shut off. Delay to reach thermal shutdown will be shortest with a dead short on the output.

### Current-Limit Induced Thermal Shutdown

Internal circuitry increases the output MOSFET on-resistance until the series combination of the MOSFET on-resistance and the load impedance limits output current to approximately 275mA. The resulting increase in power dissipation may cause the shorted channel to go into thermal shutdown. In addition, even though individual channels are thermally isolated, it is possible they may shut down when an adjacent channel is shorted. When this is undesirable, thermal shutdown can be avoided by externally responding to the fault and disabling the current-limited channel before the shutdown temperature is reached. The delay between the flag indication of a current-limit fault and thermal shutdown will vary with ambient temperature, board layout, and load impedance, but is typically several seconds. The USB controller must therefore recognize a fault and disable the appropriate channel within this time.

### Power Dissipation

Power dissipation depends on several factors such as the load, PCB layout, ambient temperature and package type.

Equations that can be used to calculate power dissipation and die temperature are found below:

Calculation of power dissipated by each channel can be accomplished by the following equation:

$$P_D = R_{DS(on)} \times (I_{OUT})^2$$

Total power dissipation of the device will be the summation of  $P_D$  for both channels. To relate this to junction temperature, the following equation can be used:

$$T_j = P_D \times \theta_{JA} + T_A$$

where:

$T_j$  = junction temperature

$T_A$  = ambient temperature

$\theta_{JA}$  = is the thermal resistance of the package

### Current Sensing and Limiting

The current-limit threshold is preset internally. The preset level prevents damage to the output MOSFET and external load but allows a minimum current of 150mA through the output MOSFET of each channel.

The current-limit circuit senses a portion of the output FET switch current. The current sense resistor shown in the block diagram is virtual and has no voltage drop. The reaction to an overcurrent condition varies with the following three scenarios:

#### Switch Enabled into Short Circuit

If a switch is enabled into a heavy load or short circuit, the switch immediately goes into a constant-current mode, reducing the output voltage. The FLG is asserted indicating an overcurrent condition.

#### Short Circuit Applied to Output

When a heavy load or short circuit is applied to an enabled switch, a large transient current may flow until the current-limit circuitry responds. Once this occurs, the device limits current to less than the maximum short-circuit current-limit specification.

#### Current-Limit Response Ramped Load

The MIC2536 current-limit profile exhibits a small foldback effect of approximately 100mA. Once this current-limit threshold is exceeded the device enters constant-current mode. This constant current is specified as the short-circuit current-limit in the "Electrical Characteristics" table. It is important to note that the MIC2536 will deliver load current up to the current-limit threshold before entering current-limited operation.

### Fault Flag

FLGx is an open-drain N-channel MOSFET output. Fault flags are active (low) for current-limit or thermal shutdown. In the case where an overcurrent condition occurs, FLG will be asserted only after the flag response delay time,  $t_D$  has elapsed. This ensures that FLG is asserted only upon valid overcurrent conditions and that erroneous error reporting is eliminated. False overcurrent conditions can occur during hot-plug events when a highly capacitive load is connected and causes a high transient inrush current that exceeds the current-limit threshold. The flag response delay time is typically 12ms.

## Applications Information

### Supply Filtering

A 0.1 $\mu$ F to 1 $\mu$ F bypass capacitor from IN to GND, located at the device, is strongly recommended to control supply transients. Without a bypass capacitor, an output short may cause sufficient ringing on the input (from supply lead inductance) to damage internal control circuitry.

*Input or output transients must not exceed the absolute maximum supply voltage ( $V_{IN(max)} = 6V$ ) even for a short duration.*

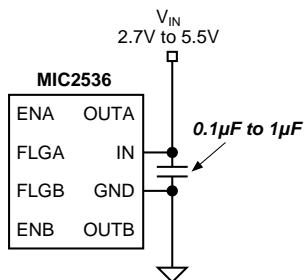

Figure 1. Supply Bypassing

### Enable Input

EN must be driven logic high or logic low for a clearly defined input. Floating the input may cause unpredictable operation. EN should not be allowed to go negative with respect to GND.

### Printed Circuit Board Hot-Plug

The MIC2536 is an ideal inrush current-limiter for hot-plug applications. Due to the integrated charge pump, the MIC2536 presents a high impedance when off and slowly becomes a low impedance as it turns on. This “soft-start” feature effectively isolates power supplies from highly capacitive loads by reducing inrush current. Figure 2 shows how the MIC2536 may be used in a hot-plug card application.

### Overcurrent Transients

The MIC2536 incorporates an internal circuit designed to prevent FLG from being asserted due to transient inrush current. Overcurrent events <12ms (typ.) will not assert FLG.

In case of large capacitive loads (i.e., >430 $\mu$ F), the length of the transient due to inrush current may exceed the delay provided by the integrated filter. Since this inrush current exceeds the current-limit delay specification, FLG will be asserted during this time. To prevent the logic controller from responding to FLG being asserted, an external RC filter, as shown in Figure 3, can be used to filter out transient FLG assertion. The value of the RC time constant should be selected to match the length of the transient, minus flag  $t_D$ .

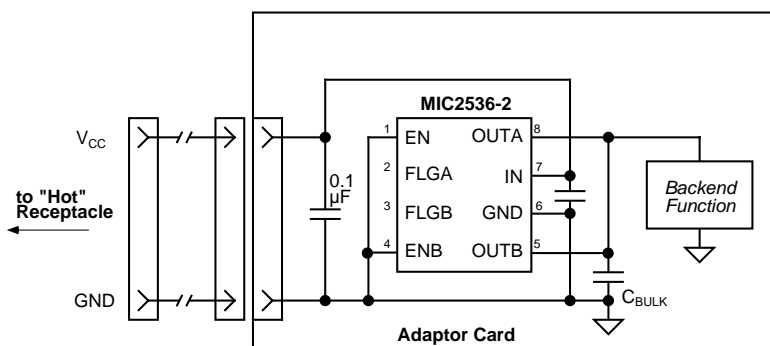

Figure 2. Hot-Plug Card Application

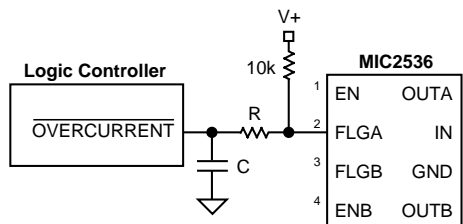
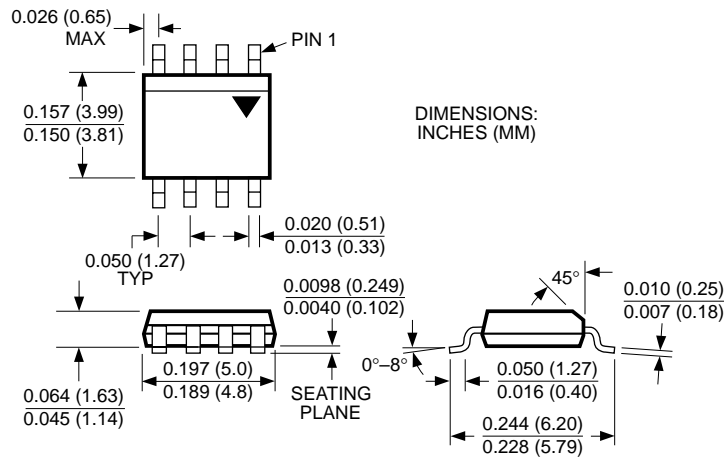

Figure 3. Transient Filter





Package Information



8-Lead SOP (M)

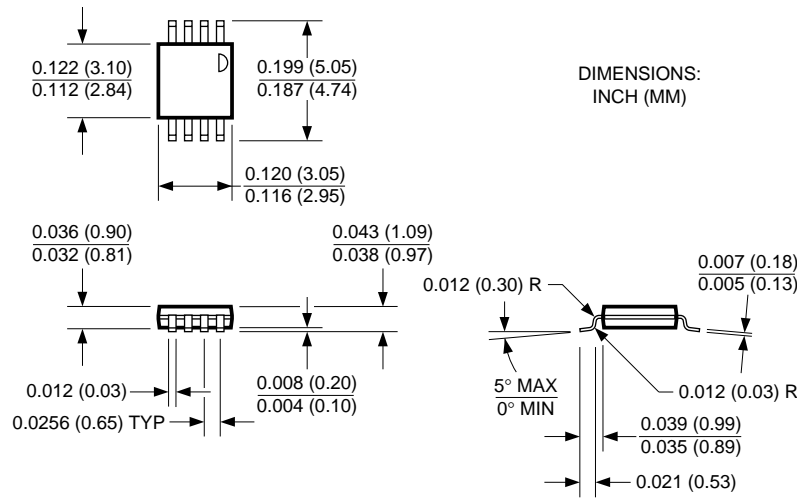

8-Lead MSOP (MM)

---

**MICREL INC. 1849 FORTUNE DRIVE SAN JOSE, CA 95131 USA**

TEL + 1 (408) 944-0800 FAX + 1 (408) 944-0970 WEB <http://www.micrel.com>

This information is believed to be accurate and reliable, however no responsibility is assumed by Micrel for its use nor for any infringement of patents or other rights of third parties resulting from its use. No license is granted by implication or otherwise under any patent or patent right of Micrel Inc.

© 2000 Micrel Incorporated

## OUR CERTIFICATE

DiGi provide top-quality products and perfect service for customer worldwide through standardization, technological innovation and continuous improvement. DiGi through third-party certification, we stricly control the quality of products and services. Welcome your RFQ to

Email: [Info@DiGi-Electronics.com](mailto:Info@DiGi-Electronics.com)



Tel: +00 852-30501935

RFQ Email: [Info@DiGi-Electronics.com](mailto:Info@DiGi-Electronics.com)

DiGi is a global authorized distributor of electronic components.