

MIC5210-2.8/3.0BMM-TR Datasheet

www.digi-electronics.com

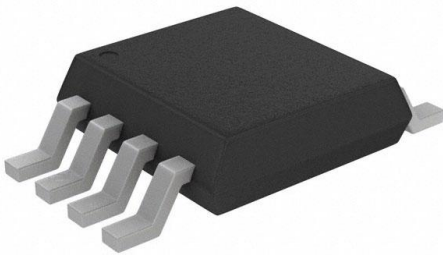

<https://www.DiGi-Electronics.com>

DiGi Electronics Part Number	MIC5210-2.8/3.0BMM-TR-DG
Manufacturer	Microchip Technology
Manufacturer Product Number	MIC5210-2.8/3.0BMM-TR
Description	IC REG LINEAR 2.8V/3V 8MSOP
Detailed Description	Linear Voltage Regulator IC Positive Fixed 2 Output 150mA, 150mA 8-MSOP



Tel: +00 852-30501935

RFQ Email: Info@DiGi-Electronics.com

DiGi is a global authorized distributor of electronic components.

Purchase and inquiry

Manufacturer Product Number:

MIC5210-2.8/3.0BMM-TR

Series:

-

Output Configuration:

Positive

Number of Regulators:

2

Voltage - Output (Min/Fixed):

2.8V, 3V

Voltage Dropout (Max):

0.35V @ 150mA, 0.35V @ 150mA

Current - Quiescent (Iq):

150 μ A

PSRR:

75dB (100Hz)

Protection Features:

Over Current, Over Temperature, Reverse Polarity

Mounting Type:

Surface Mount

Supplier Device Package:

8-MSOP

Manufacturer:

Microchip Technology

Product Status:

Discontinued at Digi-Key

Output Type:

Fixed

Voltage - Input (Max):

16V

Voltage - Output (Max):

-

Current - Output:

150mA, 150mA

Current - Supply (Max):

2.5 mA

Control Features:

Enable

Operating Temperature:

-40°C ~ 125°C

Package / Case:

8-TSSOP, 8-MSOP (0.118", 3.00mm Width)

Base Product Number:

MIC5210

Environmental & Export classification

RoHS Status:

RoHS non-compliant

REACH Status:

REACH Unaffected

HTSUS:

8542.39.0001

Moisture Sensitivity Level (MSL):

1 (Unlimited)

ECCN:

EAR99



MIC5210

Dual 150 mA LDO Regulator

Features

- Mini 8 MSOP Package
- Up to 150 mA per Regulator Output
- Low Quiescent Current
- Low Dropout Voltage
- Wide Selection of Output Voltages
- Tight Load and Line Regulation
- Low Temperature Coefficient
- Current and Thermal Limiting
- Reversed Input Polarity Protection
- Zero Off-Mode Current
- Logic-Controlled Electronic Enable

Applications

- Cellular Telephones
- Laptop, Notebook, and Palmtop Computers
- Battery-Powered Equipment
- Barcode Scanners
- SMPS Post-Regulator DC/DC Modules
- High-Efficiency Linear Power Supplies

General Description

The MIC5210 is a dual linear voltage regulator with very low dropout voltage (typically 10 mV at light loads and 140 mV at 100 mA), very low ground current (225 μ A at 10 mA output), and better than 1% initial accuracy. It also features individual logic-compatible enable/shutdown control inputs.

Both regulator outputs can supply up to 150 mA at the same time as long as each regulator's maximum junction temperature is not exceeded.

Key features include a reference bypass pin to improve its already low-noise performance, reversed-battery protection, current limiting, and overtemperature shutdown.

Designed especially for hand-held battery powered devices, the MIC5210 can be switched by a CMOS or TTL compatible logic signal, or the enable pin can be connected to the supply input for 3-terminal operation. When disabled, power consumption drops nearly to zero. Dropout ground current is minimized to prolong battery life.

The MIC5210 is available in 2.7V, 2.8V, 3.0V, 3.3V, 3.6V, 4.0V, and 5.0V fixed voltage configurations. Other voltages are available; contact Microchip for details.

Package Type

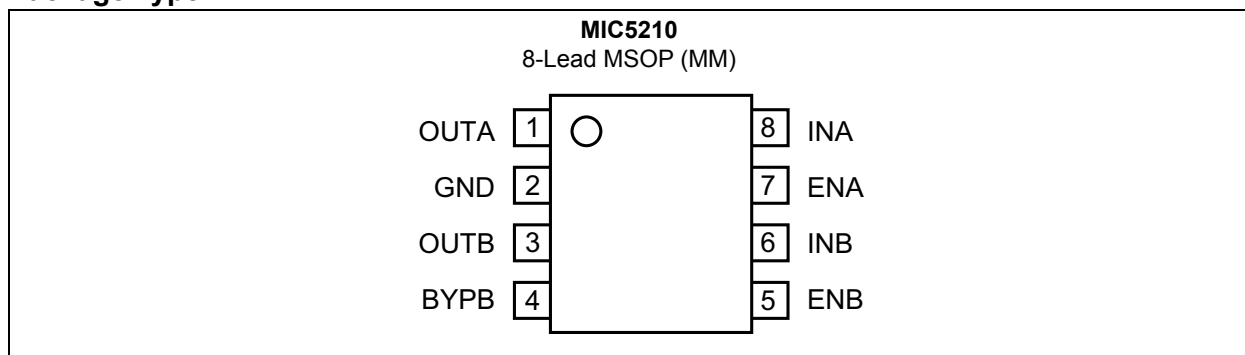

MIC5210

Typical Application Circuit

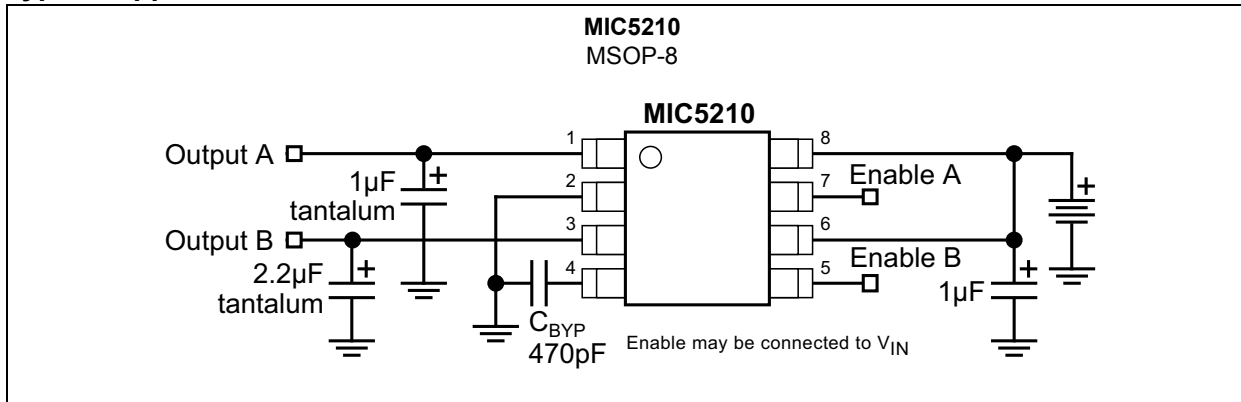

Functional Block Diagram

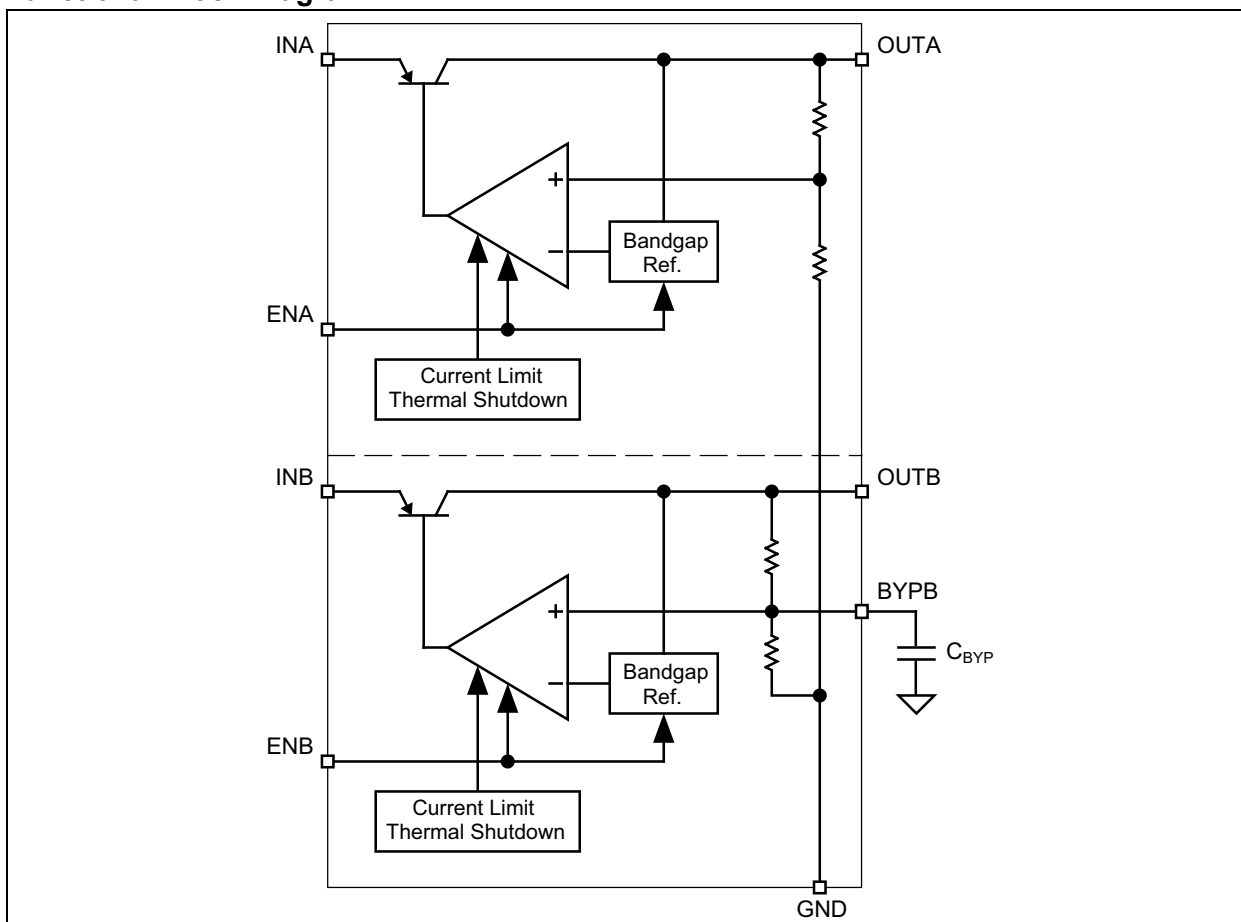

1.0 ELECTRICAL CHARACTERISTICS**Absolute Maximum Ratings †**

Supply Input Voltage (V_{IN})	-20V to +20V
Enable Input Voltage (V_{EN})	-20V to +20V
Power Dissipation (P_D)	Internally Limited

Operating Ratings ‡

Supply Input Voltage (V_{IN})	+2.5V to +16V
Enable Input Voltage (V_{EN})	0V to +16V

† **Notice:** Stresses above those listed under “Absolute Maximum Ratings” may cause permanent damage to the device. This is a stress rating only and functional operation of the device at those or any other conditions above those indicated in the operational sections of this specification is not intended. Exposure to maximum rating conditions for extended periods may affect device reliability.

‡ **Notice:** The device is not guaranteed to function outside its operating ratings.

TABLE 1-1: ELECTRICAL CHARACTERISTICS

Electrical Characteristics: $V_{IN} = V_{OUT} + 1V$; $I_L = 100 \mu A$; $C_L = 1.0 \mu F$; $V_{EN} \geq 2.0V$; $T_J = +25^\circ C$, **bold** values indicate $-40^\circ C < T_J < +125^\circ C$, unless noted.

Parameter	Symbol	Min.	Typ.	Max.	Units	Conditions
Output Voltage Accuracy	V_O	-1	—	1	%	Variation from specified V_{OUT}
		-2	—	2		
Output Voltage Temperature Coefficient	$\Delta V_O / \Delta T$	—	40	—	ppm/ $^\circ C$	Note 1
Line Regulation	$\Delta V_O / \Delta V_O$	—	0.004	0.012	%/V	$V_{IN} = V_{OUT} + 1V$ to +16V
		—	—	0.05		
Load Regulation	$\Delta V_O / \Delta V_O$	—	0.02	0.2	%	$I_L = 0.1$ mA to 150 mA (Note 2)
		—	—	0.5		
Dropout Voltage (Note 3)	$V_{IN} - V_O$	—	10	50	mV	$I_L = 100 \mu A$
		—	—	70		
		—	110	150	mV	$I_L = 50$ mA
		—	—	230		
		—	140	250	mV	$I_L = 100$ mA
		—	—	300		
		—	165	275	mV	$I_L = 150$ mA
—	—	350				
Quiescent Current	I_{GND}	—	0.01	1	μA	$V_{EN} \leq 0.4V$ (shutdown)
		—	—	5		$V_{EN} \leq 0.18V$ (shutdown)
Ground Pin Current (Note 4), per regulator	I_{GND}	—	80	125	μA	$V_{EN} \geq 2.0V$, $I_L = 100 \mu A$
		—	—	150		
		—	350	600	μA	$I_L = 50$ mA
		—	—	800		
		—	600	1000	μA	$I_L = 100$ mA
		—	—	1500		
		—	1300	1900	μA	$I_L = 150$ mA
—	—	2500				
Ripple Rejection	PSRR	—	75	—	dB	Frequency = 100 Hz, $I_L = 100 \mu A$

MIC5210

TABLE 1-1: ELECTRICAL CHARACTERISTICS (CONTINUED)

Electrical Characteristics: $V_{IN} = V_{OUT} + 1V$; $I_L = 100 \mu A$; $C_L = 1.0 \mu F$; $V_{EN} \geq 2.0V$; $T_J = +25^\circ C$, **bold** values indicate $-40^\circ C < T_J < +125^\circ C$, unless noted.

Parameter	Symbol	Min.	Typ.	Max.	Units	Conditions
Current Limit	I_{LIMIT}	—	320	500	mA	$V_{OUT} = 0V$
Thermal Regulation	$\Delta V_O / \Delta P_D$	—	0.05	—	%/W	Note 5
Output Noise (Regulator B only)	e_{no}	—	260	—	nV/ \sqrt{Hz}	$I_L = 50 mA$, $C_L = 2.2 \mu F$, 470 pF from BYPB to GND
Enable Input Logic-Low Voltage	V_{IL}	—	—	0.4	V	Regulator shutdown
		—	—	0.18		
Enable Input Logic-High Voltage	V_{IH}	2.0	—	—	V	Regulator enabled
Enable Input Current	I_{IL}	—	0.01	-1	μA	$V_{IL} \leq 0.4V$
		—	—	-2		$V_{IL} \leq 0.18V$
	I_{IH}	—	5	20	μA	$V_{IH} \geq 2.0V$
		—	—	25		$V_{IH} \geq 2.0V$

- Note 1:** Output voltage temperature coefficient is defined as the worst case voltage change divided by the total temperature range.
- 2:** Regulation is measured at constant junction temperature using low duty cycle pulse testing. Parts are tested for load regulation in the load range from 0.1 mA to 150 mA. Changes in output voltage due to heating effects are covered by the thermal regulation specification.
- 3:** Dropout Voltage is defined as the input to output differential at which the output voltage drops 2% below its nominal value measured at 1V differential.
- 4:** Ground pin current is the regulator quiescent current plus pass transistor base current. The total current drawn from the supply is the sum of the load current plus the ground pin current.
- 5:** Thermal regulation is defined as the change in output voltage at a time “t” after a change in power dissipation is applied, excluding load or line regulation effects. Specifications are for a 150 mA load pulse at $V_{IN} = 16V$ for $t = 10 ms$.

TEMPERATURE SPECIFICATIONS (Note 1)

Parameters	Sym.	Min.	Typ.	Max.	Units	Conditions
Temperature Ranges						
Junction Operating Temperature Range	T_J	-40	—	+85	°C	—
Storage Temperature Range	T_S	-60	—	+150	°C	—
Lead Temperature	—	—	—	+260	°C	Soldering, 5s
Package Thermal Resistances						
Thermal Resistance MSOP-8	θ_{JA}	—	200	—	°C/W	Note 2

- Note 1:** The maximum allowable power dissipation is a function of ambient temperature, the maximum allowable junction temperature and the thermal resistance from junction to air (i.e., T_A , T_J , θ_{JA}). Exceeding the maximum allowable power dissipation will cause the device operating junction temperature to exceed the maximum +85°C rating. Sustained junction temperatures above +85°C can impact the device reliability.
- 2:** Absolute maximum ratings indicate limits beyond which damage to the component may occur. Electrical specifications do not apply when operating the device outside of its operating ratings. The maximum allowable power dissipation is a function of the maximum junction temperature, $T_{J(max)}$, the junction-to-ambient thermal resistance, θ_{JA} , and the ambient temperature, T_A . The maximum allowable power dissipation at any ambient temperature is calculated using: $P_{D(max)} = (T_{J(max)} - T_A)/\theta_{JA}$. Exceeding the maximum allowable power dissipation will result in excessive die temperature, and the regulator will go into thermal shutdown. The θ_{JA} of the 8-pin MSOP (MM) is 200°C/W mounted on a PC board (see “Thermal Considerations” section for further details).

MIC5210

2.0 TYPICAL PERFORMANCE CURVES

Note: The graphs and tables provided following this note are a statistical summary based on a limited number of samples and are provided for informational purposes only. The performance characteristics listed herein are not tested or guaranteed. In some graphs or tables, the data presented may be outside the specified operating range (e.g., outside specified power supply range) and therefore outside the warranted range.

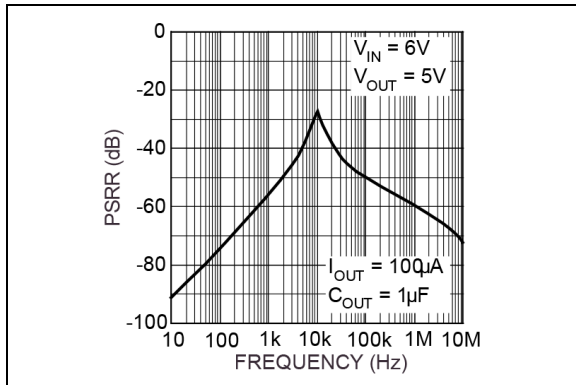

FIGURE 2-1: Power Supply Rejection Ratio.

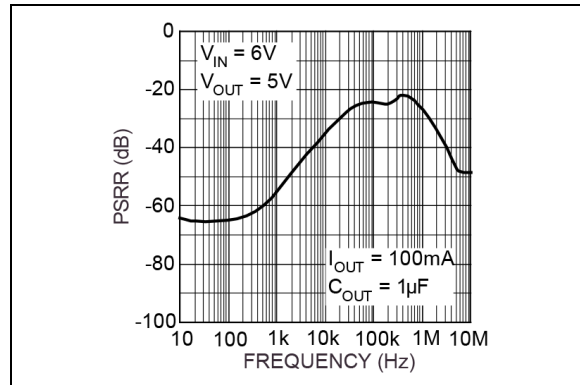

FIGURE 2-4: Power Supply Rejection Ratio.

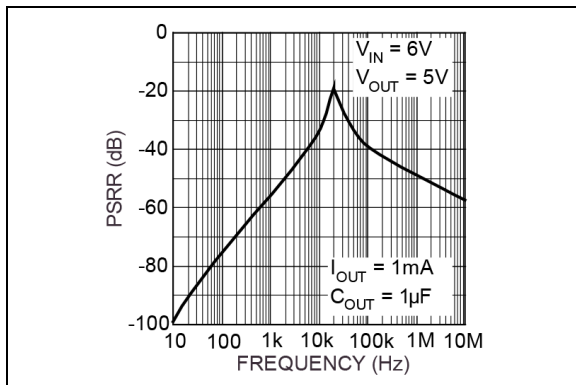

FIGURE 2-2: Power Supply Rejection Ratio.

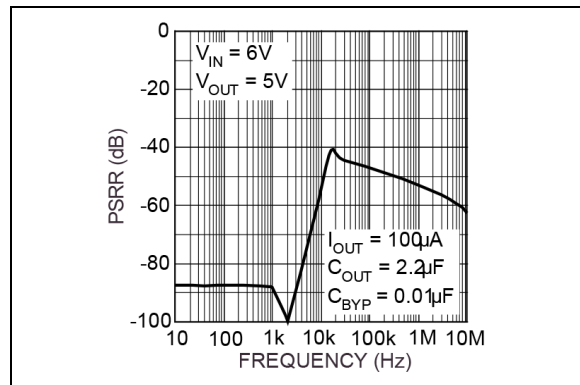

FIGURE 2-5: Power Supply Rejection Ratio.

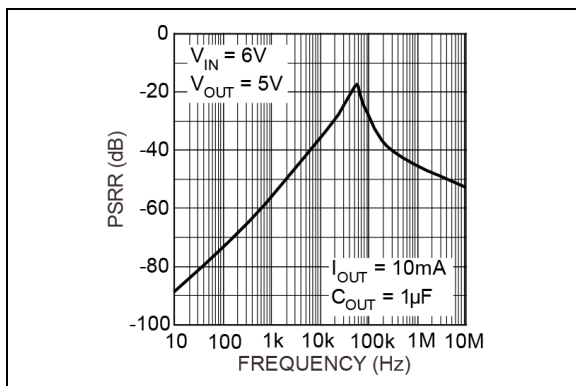

FIGURE 2-3: Power Supply Rejection Ratio.

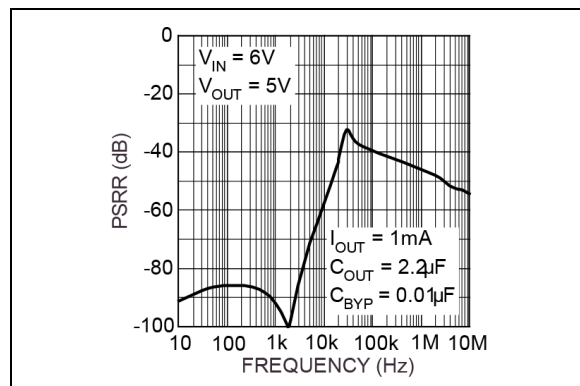

FIGURE 2-6: Power Supply Rejection Ratio.

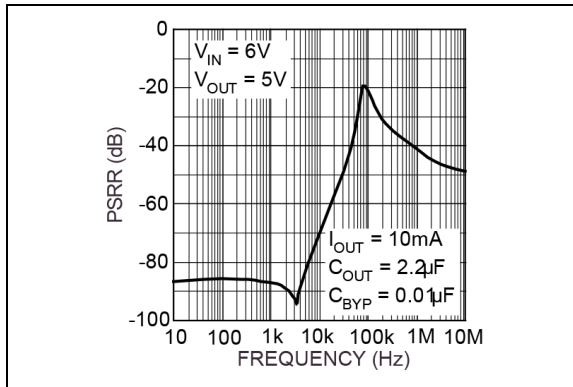

FIGURE 2-7: Power Supply Rejection Ratio.

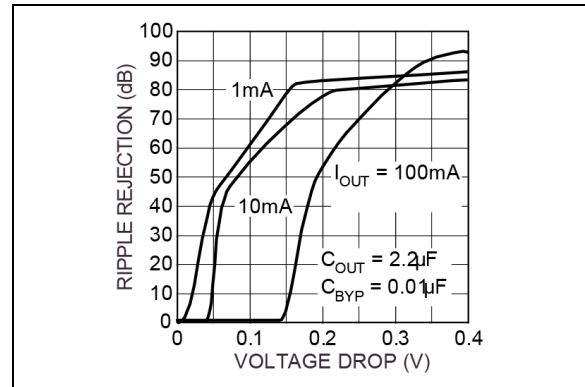

FIGURE 2-10: Power Supply Ripple Rejection vs. Voltage Drop.

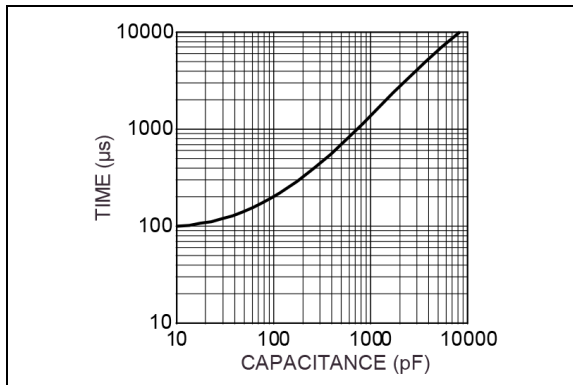

FIGURE 2-8: Turn-On Time vs. Bypass Capacitance.

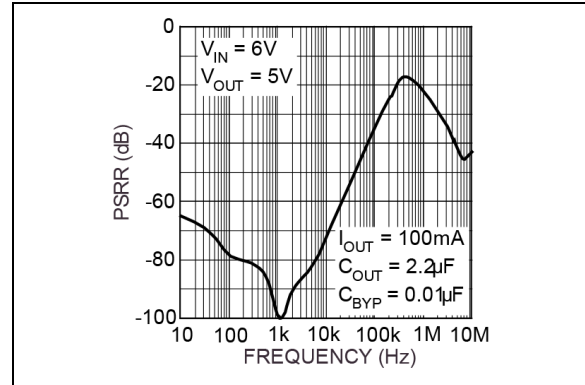

FIGURE 2-11: Power Supply Rejection Ratio.

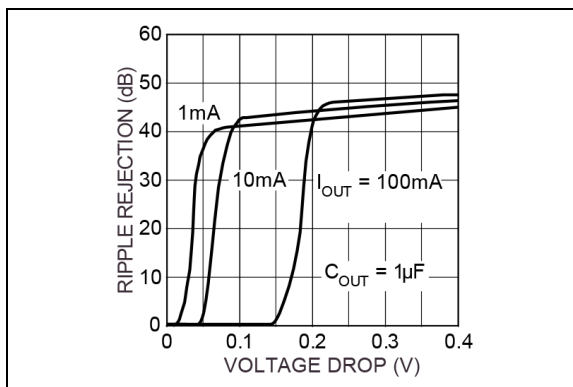

FIGURE 2-9: Power Supply Ripple Rejection vs. Voltage Drop.

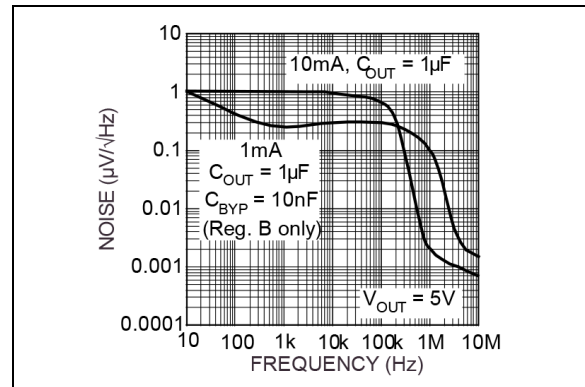

FIGURE 2-12: Noise Performance.

MIC5210

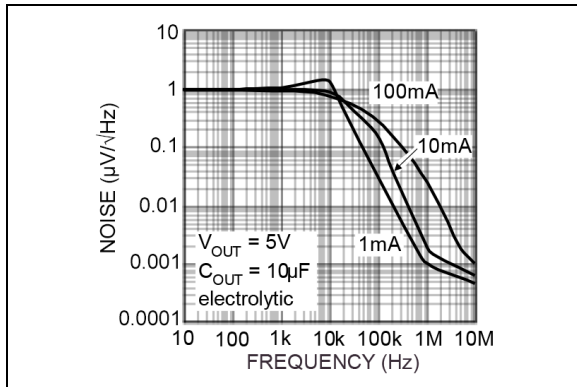

FIGURE 2-13: Noise Performance.

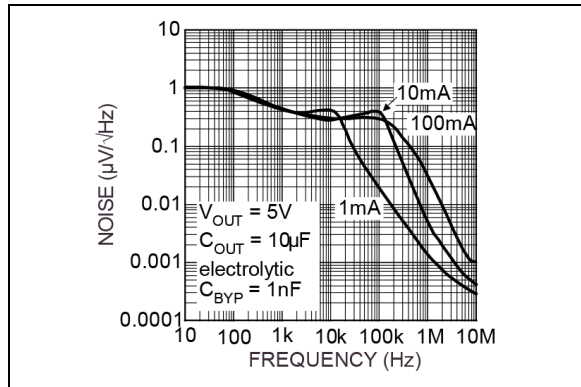

FIGURE 2-16: Noise Performance (Regulator B).

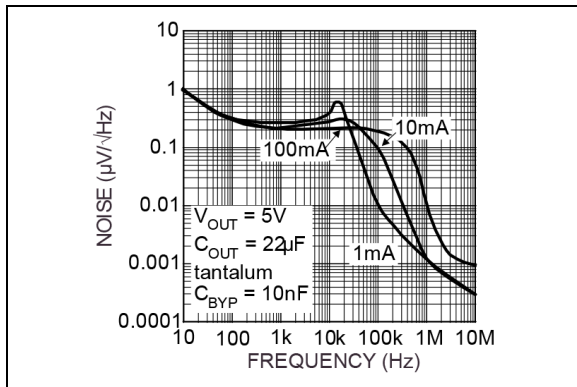

FIGURE 2-14: Noise Performance (Regulator B).

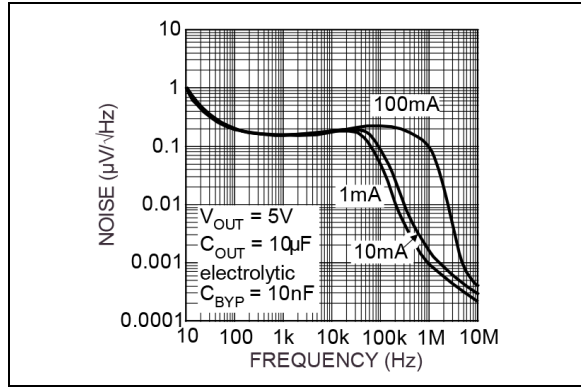

FIGURE 2-17: Noise Performance (Regulator B).

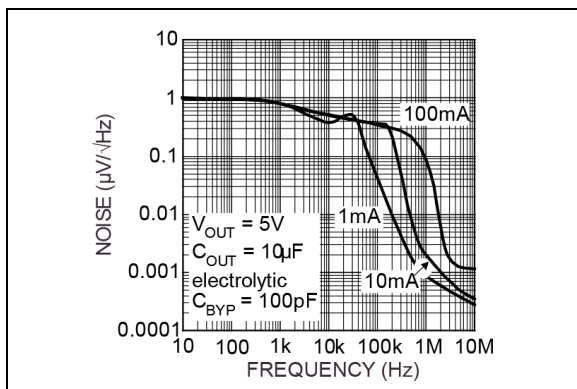

FIGURE 2-15: Noise Performance (Regulator B).

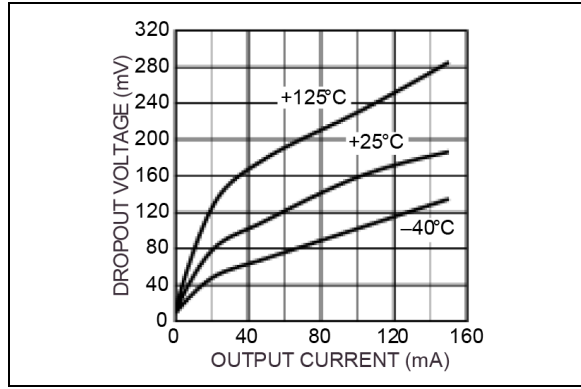

FIGURE 2-18: Dropout Voltage vs. Output Current.

3.0 PIN DESCRIPTIONS

The descriptions of the pins are listed in [Table 3-1](#).

TABLE 3-1: PIN FUNCTION TABLE

Pin Number	Pin Name	Description
1	OUTA	Regulator Output A
2	GND	Ground
3	OUTB	Regulator Output B
4	BYPB	Reference Bypass B: Connect external 470 pF capacitor to GND to reduce output noise in regulator "B". May be left open.
5	ENB	Enable/Shutdown B (Input): CMOS-compatible input. Logic-high = enable, logic-low = shutdown. Do not leave floating.
6	INB	Supply Input B
7	ENA	Enable/Shutdown A (Input): CMOS-compatible input. Logic-high = enable, logic-low = shutdown. Do not leave floating.
8	INA	Supply Input A

MIC5210

4.0 APPLICATION INFORMATION

4.1 Enable/Shutdown

Forcing EN (enable/shutdown) high (greater than 2V) enables the regulator. EN is compatible with CMOS and TTL logic gates.

If the enable/shutdown feature is not required, connect EN to IN (supply input).

4.2 Input Capacitor

A 1 μF capacitor should be placed from IN to GND if there is more than 10 inches of wire between the input and the AC filter capacitor or if a battery is used as the input.

4.3 Reference Bypass Capacitor

BYPB (reference bypass) is connected to the internal voltage reference of regulator B. A 470 pF capacitor (C_{BYP}) connected from BYPB to GND quiets this reference, providing a significant reduction in output noise. C_{BYP} reduces the regulator phase margin; when using C_{BYP} , output capacitors of 2.2 μF or greater are generally required to maintain stability.

The start-up speed of the MIC5210 is inversely proportional to the size of the reference bypass capacitor. Applications requiring a slow ramp-up of output voltage should consider larger values of C_{BYP} . Likewise, if rapid turn-on is necessary, consider omitting C_{BYP} .

If output noise is not a major concern, omit C_{BYP} and leave BYPB open.

4.4 Output Capacitor

An output capacitor is required between OUT and GND to prevent oscillation. The minimum size of the output capacitor is dependent upon whether a reference bypass capacitor is used. 1.0 μF minimum is recommended when CBYP is not used. 2.2 μF minimum is recommended when C_{BYP} is 470 pF (see [Typical Application Circuit](#)). Larger values improve the regulator's transient response. The output capacitor value may be increased without limit.

The output capacitor should have an ESR (effective series resistance) of about 5 Ω or less and a resonant frequency above 1 MHz. Ultralow-ESR capacitors may cause a low-amplitude oscillation and/or underdamped transient response. Most tantalum or aluminum electrolytic capacitors are adequate; film types will work, but are more expensive. Because many aluminum electrolytic capacitors have electrolytes that freeze at about -30°C , solid tantalum capacitors are recommended for operation below -25°C .

At lower values of output current, less output capacitance is required for output stability. The capacitor can be reduced to 0.47 μF for current below 10 mA or 0.33 μF for currents below 1 mA.

4.5 No-Load Stability

The MIC5210 will remain stable and in regulation with no load (other than the internal voltage divider) unlike many other voltage regulators. This is especially important in CMOS RAM keep-alive applications.

4.6 Dual-Supply Operation

When used in dual supply systems where the regulator load is returned to a negative supply, the output voltage must be diode clamped to ground.

4.7 Thermal Considerations

Multilayer boards having a ground plane, wide traces near the pads, and large supply bus lines provide better thermal conductivity.

The MIC5210-xxYMM (8-pin MSOP) has a thermal resistance of $200^{\circ}\text{C}/\text{W}$ when mounted on a FR4 board with minimum trace widths and no ground plane.

For additional heat sink characteristics, please refer to [Application Hint 17, "Designing P.C. Board Heat Sinks."](#)

4.7.1 THERMAL EVALUATION EXAMPLES

For example, at 50°C ambient temperature, the maximum package power dissipation is:

EQUATION 4-1:

$$P_{D(MAX)} = (125^{\circ}\text{C} - 50^{\circ}\text{C}) / (200^{\circ}\text{C}/\text{W}) = 375\text{mW}$$

If the intent is to operate the 5V version from a 6V supply at the full 150mA load for both outputs in a 50°C maximum ambient temperature, make the following calculation:

EQUATION 4-2:

$$P_{D(EACHREG)} = (V_{IN} - V_{OUT}) \times I_{OUT} + (V_{IN} \times I_{GND})$$

EQUATION 4-3:

$$P_{D(EACHREG)} = (6V - 5V) \times 150mA + (6V \times 2.5mA) \\ = 165mW$$

EQUATION 4-4:

$$P_{D(BOTHREG)} = 2Regulators \times 165mW = 330mW$$

The actual total power dissipation of 330 mW is below the 375 mW package maximum; therefore, the regulator can be used.

Note that both regulators cannot always be used at their maximum current rating. For example, in a 5V input to 3.3V output application at +50°C, if one regulator supplies 150 mA, the other regulator is limited to a much lower current. The first regulator dissipates:

EQUATION 4-5:

$$P_D = (5V - 3.3V) \times 150mA + (5V \times 2.5mA) \\ = 267.5mW$$

Then, the load that the remaining regulator can dissipate must not exceed 375 mW – 267.5 mW = 107.5 mW.

This means, using the same 5V input and 3.3V output voltage, the second regulator is limited to about 60 mA.

Taking advantage of the extremely low-dropout voltage characteristics of the MIC5210, power dissipation can be reduced by using the lowest possible input voltage to minimize the input-to-output voltage drop.

MIC5210

5.0 PACKAGING INFORMATION

5.1 Package Marking Information

8-Lead MSOP*

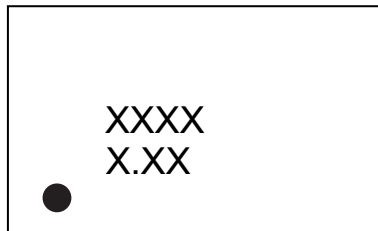

Example

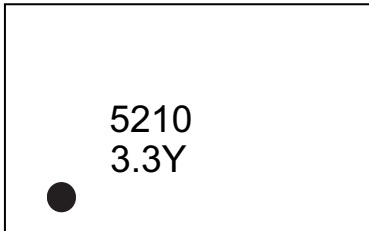

Legend:	XX...X	Product code or customer-specific information
	Y	Year code (last digit of calendar year)
	YY	Year code (last 2 digits of calendar year)
	WW	Week code (week of January 1 is week '01')
	NNN	Alphanumeric traceability code
	(e3)	Pb-free JEDEC [®] designator for Matte Tin (Sn)
	*	This package is Pb-free. The Pb-free JEDEC designator ((e3)) can be found on the outer packaging for this package.
	•, ▲, ▼	Pin one index is identified by a dot, delta up, or delta down (triangle mark).
Note:	In the event the full Microchip part number cannot be marked on one line, it will be carried over to the next line, thus limiting the number of available characters for customer-specific information. Package may or may not include the corporate logo.	
	Underbar (¯) and/or Overbar (¯) symbol may not be to scale.	

8-Lead MSOP Package Outline and Recommended Land Pattern**TITLE**

8 LEAD MSOP PACKAGE OUTLINE & RECOMMENDED LAND PATTERN

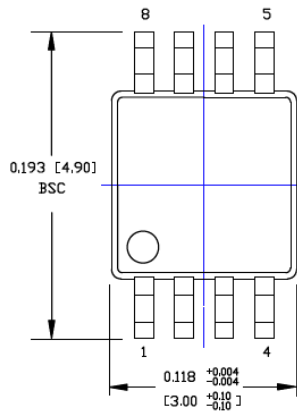
DRAWING # MSOP-8LD-PL-1**UNIT** INCH [MM]

TOP VIEW

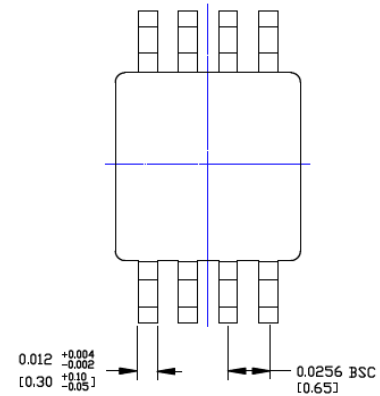

BOTTOM VIEW

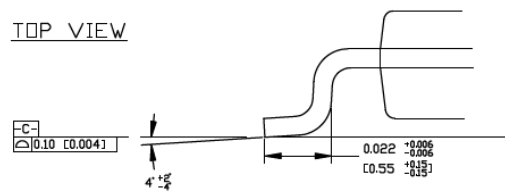

DETAIL A

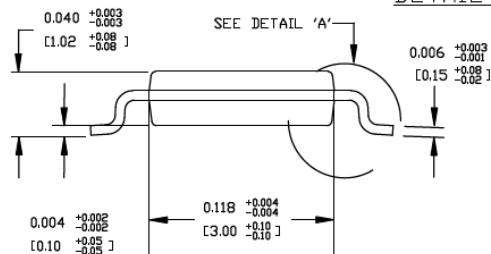

SIDE VIEW

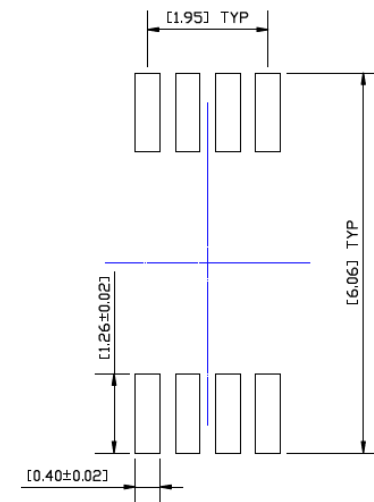

RECOMMENDED LAND PATTERN

NOTES:

1. DIMENSIONS ARE IN INCHES [MM].
2. CONTROLLING DIMENSION: MM
3. DIMENSION DOES NOT INCLUDE MOLD FLASH OR PROTRUSIONS, EITHER OF WHICH SHALL NOT EXCEED 0.008 [0.20] PER SIDE.

Note: For the most current package drawings, please see the Microchip Packaging Specification located at <http://www.microchip.com/packaging>.

MIC5210

NOTES:

APPENDIX A: REVISION HISTORY

Revision A (March 2019)

- Converted Micrel document MIC5210 to Microchip data sheet DS20006096A.
- Minor text changes throughout.

MIC5210

NOTES:

PRODUCT IDENTIFICATION SYSTEM

To order or obtain information, e.g., on pricing or delivery, contact your local Microchip representative or sales office.

<u>PART NO.</u>	<u>-X.X</u>	<u>X</u>	<u>XX</u>	<u>-XX</u>
Device	Voltage	Temperature	Package	Media Type
Device:	MIC5210:	Dual 150 mA LDO Regulator		
Voltage:	2.8 = 2.8V 3.0 = 3.0V 3.3 = 3.3V 5.0 = 5.0V			
Temperature:	Y = -40°C to +125°C			
Package:	MM = 8-Lead MSOP			
Media Type:	<blank>= 100/Tube TR = 2,500/Reel			

Examples:	
a) MIC5210-2.8YMM:	Dual 150 mA LDO Regulator, 2.8V, -40°C to +125°C, 8-Lead MSOP, 100/Tube
b) MIC5210-3.0YMM:	Dual 150 mA LDO Regulator, 3.0V, -40°C to +125°C, 8-Lead MSOP, 100/Tube
c) MIC5210-3.3YMM:	Dual 150 mA LDO Regulator, 3.3V, -40°C to +125°C, 8-Lead MSOP, 100/Tube
d) MIC5210-5.0YMM:	Dual 150 mA LDO Regulator, 5.0V, -40°C to +125°C, 8-Lead MSOP, 100/Tube
e) MIC5210-2.8YMM-TR:	Dual 150 mA LDO Regulator, 2.8V, -40°C to +125°C, 8-Lead MSOP, 2,500/Reel
f) MIC5210-3.0YMM-TR:	Dual 150 mA LDO Regulator, 3.0V, -40°C to +125°C, 8-Lead MSOP, 2,500/Reel
g) MIC5210-3.3YMM-TR:	Dual 150 mA LDO Regulator, 3.3V, -40°C to +125°C, 8-Lead MSOP, 2,500/Reel
h) MIC5210-5.0YMM-TR:	Dual 150 mA LDO Regulator, 5.0V, -40°C to +125°C, 8-Lead MSOP, 2,500/Reel
Note 1:	Tape and Reel identifier only appears in the catalog part number description. This identifier is used for ordering purposes and is not printed on the device package. Check with your Microchip Sales Office for package availability with the Tape and Reel option.

MIC5210

NOTES:

Note the following details of the code protection feature on Microchip devices:

- Microchip products meet the specification contained in their particular Microchip Data Sheet.
- Microchip believes that its family of products is one of the most secure families of its kind on the market today, when used in the intended manner and under normal conditions.
- There are dishonest and possibly illegal methods used to breach the code protection feature. All of these methods, to our knowledge, require using the Microchip products in a manner outside the operating specifications contained in Microchip's Data Sheets. Most likely, the person doing so is engaged in theft of intellectual property.
- Microchip is willing to work with the customer who is concerned about the integrity of their code.
- Neither Microchip nor any other semiconductor manufacturer can guarantee the security of their code. Code protection does not mean that we are guaranteeing the product as “unbreakable.”

Code protection is constantly evolving. We at Microchip are committed to continuously improving the code protection features of our products. Attempts to break Microchip's code protection feature may be a violation of the Digital Millennium Copyright Act. If such acts allow unauthorized access to your software or other copyrighted work, you may have a right to sue for relief under that Act.

Information contained in this publication regarding device applications and the like is provided only for your convenience and may be superseded by updates. It is your responsibility to ensure that your application meets with your specifications. MICROCHIP MAKES NO REPRESENTATIONS OR WARRANTIES OF ANY KIND WHETHER EXPRESS OR IMPLIED, WRITTEN OR ORAL, STATUTORY OR OTHERWISE, RELATED TO THE INFORMATION, INCLUDING BUT NOT LIMITED TO ITS CONDITION, QUALITY, PERFORMANCE, MERCHANTABILITY OR FITNESS FOR PURPOSE. Microchip disclaims all liability arising from this information and its use. Use of Microchip devices in life support and/or safety applications is entirely at the buyer's risk, and the buyer agrees to defend, indemnify and hold harmless Microchip from any and all damages, claims, suits, or expenses resulting from such use. No licenses are conveyed, implicitly or otherwise, under any Microchip intellectual property rights unless otherwise stated.

Microchip received ISO/TS-16949:2009 certification for its worldwide headquarters, design and wafer fabrication facilities in Chandler and Tempe, Arizona; Gresham, Oregon and design centers in California and India. The Company's quality system processes and procedures are for its PIC® MCUs and dsPIC® DSCs, KEELOQ® code hopping devices, Serial EEPROMs, microperipherals, nonvolatile memory and analog products. In addition, Microchip's quality system for the design and manufacture of development systems is ISO 9001:2000 certified.

**QUALITY MANAGEMENT SYSTEM
CERTIFIED BY DNV
= ISO/TS 16949 =**

Trademarks

The Microchip name and logo, the Microchip logo, AnyRate, AVR, AVR logo, AVR Freaks, BitCloud, chipKIT, chipKIT logo, CryptoMemory, CryptoRF, dsPIC, FlashFlex, flexPWR, Heldo, JukeBlox, KeeLoq, Klear, LANCheck, LINK MD, maXStylus, maXTouch, MediaLB, megaAVR, MOST, MOST logo, MPLAB, OptoLyzer, PIC, picoPower, PICSTART, PIC32 logo, Prochip Designer, QTouch, SAM-BA, SpyNIC, SST, SST Logo, SuperFlash, tinyAVR, UNI/O, and XMEGA are registered trademarks of Microchip Technology Incorporated in the U.S.A. and other countries.

ClockWorks, The Embedded Control Solutions Company, EtherSynch, Hyper Speed Control, HyperLight Load, IntellIMOS, mTouch, Precision Edge, and Quiet-Wire are registered trademarks of Microchip Technology Incorporated in the U.S.A.

Adjacent Key Suppression, AKS, Analog-for-the-Digital Age, Any Capacitor, AnyIn, AnyOut, BodyCom, CodeGuard, CryptoAuthentication, CryptoAutomotive, CryptoCompanion, CryptoController, dsPICDEM, dsPICDEM.net, Dynamic Average Matching, DAM, ECAN, EtherGREEN, In-Circuit Serial Programming, ICSP, INICnet, Inter-Chip Connectivity, JitterBlocker, KlearNet, KlearNet logo, memBrain, Mindi, MiWi, motorBench, MPASM, MPF, MPLAB Certified logo, MPLIB, MPLINK, MultiTRAK, NetDetach, Omniscient Code Generation, PICDEM, PICDEM.net, PICKit, PICtail, PowerSmart, PureSilicon, QMatrix, REAL ICE, Ripple Blocker, SAM-ICE, Serial Quad I/O, SMART-I.S., SQI, SuperSwitcher, SuperSwitcher II, Total Endurance, TSHARC, USBCheck, VariSense, ViewSpan, WiperLock, Wireless DNA, and ZENA are trademarks of Microchip Technology Incorporated in the U.S.A. and other countries.

SQTP is a service mark of Microchip Technology Incorporated in the U.S.A.

Silicon Storage Technology is a registered trademark of Microchip Technology Inc. in other countries.

GestIC is a registered trademark of Microchip Technology Germany II GmbH & Co. KG, a subsidiary of Microchip Technology Inc., in other countries.

All other trademarks mentioned herein are property of their respective companies.

© 2019, Microchip Technology Incorporated, All Rights Reserved.
ISBN: 978-1-5224-4272-1



MICROCHIP

Worldwide Sales and Service

AMERICAS

Corporate Office
2355 West Chandler Blvd.
Chandler, AZ 85224-6199
Tel: 480-792-7200
Fax: 480-792-7277
Technical Support:
<http://www.microchip.com/support>
Web Address:
www.microchip.com

Atlanta
Duluth, GA
Tel: 678-957-9614
Fax: 678-957-1455

Austin, TX
Tel: 512-257-3370

Boston
Westborough, MA
Tel: 774-760-0087
Fax: 774-760-0088

Chicago
Itasca, IL
Tel: 630-285-0071
Fax: 630-285-0075

Dallas
Addison, TX
Tel: 972-818-7423
Fax: 972-818-2924

Detroit
Novi, MI
Tel: 248-848-4000

Houston, TX
Tel: 281-894-5983

Indianapolis
Noblesville, IN
Tel: 317-773-8323
Fax: 317-773-5453
Tel: 317-536-2380

Los Angeles
Mission Viejo, CA
Tel: 949-462-9523
Fax: 949-462-9608
Tel: 951-273-7800

Raleigh, NC
Tel: 919-844-7510

New York, NY
Tel: 631-435-6000

San Jose, CA
Tel: 408-735-9110
Tel: 408-436-4270

Canada - Toronto
Tel: 905-695-1980
Fax: 905-695-2078

ASIA/PACIFIC

Australia - Sydney
Tel: 61-2-9868-6733

China - Beijing
Tel: 86-10-8569-7000

China - Chengdu
Tel: 86-28-8665-5511

China - Chongqing
Tel: 86-23-8980-9588

China - Dongguan
Tel: 86-769-8702-9880

China - Guangzhou
Tel: 86-20-8755-8029

China - Hangzhou
Tel: 86-571-8792-8115

China - Hong Kong SAR
Tel: 852-2943-5100

China - Nanjing
Tel: 86-25-8473-2460

China - Qingdao
Tel: 86-532-8502-7355

China - Shanghai
Tel: 86-21-3326-8000

China - Shenyang
Tel: 86-24-2334-2829

China - Shenzhen
Tel: 86-755-8864-2200

China - Suzhou
Tel: 86-186-6233-1526

China - Wuhan
Tel: 86-27-5980-5300

China - Xian
Tel: 86-29-8833-7252

China - Xiamen
Tel: 86-592-2388138

China - Zhuhai
Tel: 86-756-3210040

ASIA/PACIFIC

India - Bangalore
Tel: 91-80-3090-4444

India - New Delhi
Tel: 91-11-4160-8631

India - Pune
Tel: 91-20-4121-0141

Japan - Osaka
Tel: 81-6-6152-7160

Japan - Tokyo
Tel: 81-3-6880-3770

Korea - Daegu
Tel: 82-53-744-4301

Korea - Seoul
Tel: 82-2-554-7200

Malaysia - Kuala Lumpur
Tel: 60-3-7651-7906

Malaysia - Penang
Tel: 60-4-227-8870

Philippines - Manila
Tel: 63-2-634-9065

Singapore
Tel: 65-6334-8870

Taiwan - Hsin Chu
Tel: 886-3-577-8366

Taiwan - Kaohsiung
Tel: 886-7-213-7830

Taiwan - Taipei
Tel: 886-2-2508-8600

Thailand - Bangkok
Tel: 66-2-694-1351

Vietnam - Ho Chi Minh
Tel: 84-28-5448-2100

EUROPE

Austria - Wels
Tel: 43-7242-2244-39
Fax: 43-7242-2244-393

Denmark - Copenhagen
Tel: 45-4450-2828
Fax: 45-4485-2829

Finland - Espoo
Tel: 358-9-4520-820

France - Paris
Tel: 33-1-69-53-63-20
Fax: 33-1-69-30-90-79

Germany - Garching
Tel: 49-8931-9700

Germany - Haan
Tel: 49-2129-3766400

Germany - Heilbronn
Tel: 49-7131-67-3636

Germany - Karlsruhe
Tel: 49-721-625370

Germany - Munich
Tel: 49-89-627-144-0
Fax: 49-89-627-144-44

Germany - Rosenheim
Tel: 49-8031-354-560

Israel - Ra'anana
Tel: 972-9-744-7705

Italy - Milan
Tel: 39-0331-742611
Fax: 39-0331-466781

Italy - Padova
Tel: 39-049-7625286

Netherlands - Drunen
Tel: 31-416-690399
Fax: 31-416-690340

Norway - Trondheim
Tel: 47-7288-4388

Poland - Warsaw
Tel: 48-22-3325737

Romania - Bucharest
Tel: 40-21-407-87-50

Spain - Madrid
Tel: 34-91-708-08-90
Fax: 34-91-708-08-91

Sweden - Gothenberg
Tel: 46-31-704-60-40

Sweden - Stockholm
Tel: 46-8-5090-4654

UK - Wokingham
Tel: 44-118-921-5800
Fax: 44-118-921-5820

OUR CERTIFICATE

DiGi provide top-quality products and perfect service for customer worldwide through standardization, technological innovation and continuous improvement. DiGi through third-party certification, we strictly control the quality of products and services. Welcome your RFQ to

Email: Info@DiGi-Electronics.com



Tel: +00 852-30501935

RFQ Email: Info@DiGi-Electronics.com

DiGi is a global authorized distributor of electronic components.