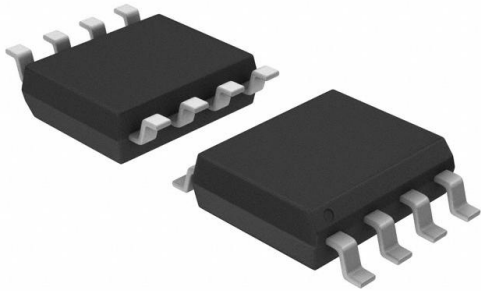


# MIC5212-SJYM-TR Datasheet

[www.digi-electronics.com](http://www.digi-electronics.com)



<https://www.DiGi-Electronics.com>

DiGi Electronics Part Number	MIC5212-SJYM-TR-DG
Manufacturer	<a href="#">Microchip Technology</a>
Manufacturer Product Number	MIC5212-SJYM-TR
Description	IC REG LINEAR 2.5V/3.3V 8SOIC
Detailed Description	Linear Voltage Regulator IC Positive Fixed 2 Output 500mA, 500mA 8-SOIC



Tel: +00 852-30501935

RFQ Email: [Info@DiGi-Electronics.com](mailto:Info@DiGi-Electronics.com)

DiGi is a global authorized distributor of electronic components.

## Purchase and inquiry

Manufacturer Product Number:

MIC5212-SJYM-TR

Series:

-

Output Configuration:

Positive

Number of Regulators:

2

Voltage - Output (Min/Fixed):

2.5V, 3.3V

Voltage Dropout (Max):

0.6V @ 500mA, 0.6V @ 500mA

Current - Quiescent (Iq):

3 mA

PSRR:

75dB (120Hz)

Protection Features:

Over Current, Over Temperature, Reverse Polarity

Mounting Type:

Surface Mount

Supplier Device Package:

8-SOIC

Manufacturer:

Microchip Technology

Product Status:

Active

Output Type:

Fixed

Voltage - Input (Max):

16V

Voltage - Output (Max):

-

Current - Output:

500mA, 500mA

Current - Supply (Max):

25 mA

Control Features:

-

Operating Temperature:

-40°C ~ 125°C

Package / Case:

8-SOIC (0.154", 3.90mm Width)

Base Product Number:

MIC5212

## Environmental & Export classification

RoHS Status:

ROHS3 Compliant

REACH Status:

REACH Unaffected

HTSUS:

8542.39.0001

Moisture Sensitivity Level (MSL):

1 (Unlimited)

ECCN:

EAR99





# MIC5212

## Dual 500 mA LDO Regulator

### Features

- Fused-Lead Frame SOIC-8
- Up to 500 mA per Regulator Output
- Low Quiescent Current
- Low Dropout Voltage
- Tight Load and Line Regulation
- Low Temperature Coefficient
- Current and Thermal Limiting
- Reversed Input Polarity Protection

### Applications

- Hard Disk Drives
- CD R/W
- Barcode Scanners
- SMPS Post Regulator and DC/DC Modules
- High-Efficiency Linear Power Supplies

### General Description

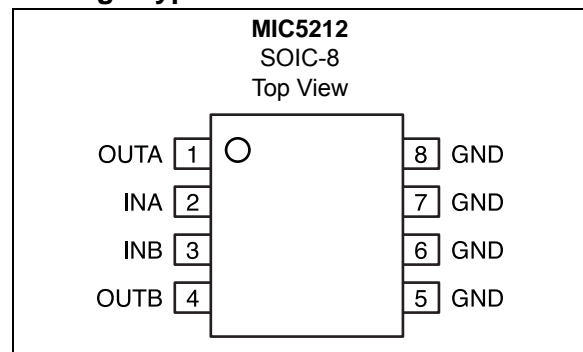
The MIC5212 is a dual linear voltage regulator with very low dropout voltage (typically 10 mV at light loads and 350 mV at 500 mA), very low ground current (225  $\mu$ A at 10 mA output), and better than 1% initial accuracy.

Both regulator outputs can supply up to 500 mA at the same time as long as each regulator's maximum junction temperature is not exceeded.

Key features include current limiting, overtemperature shutdown, and protection against reversed battery.

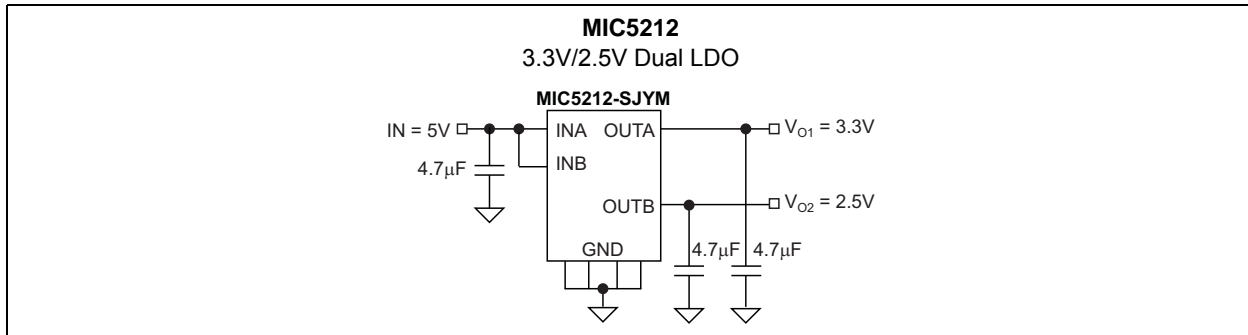
The MIC5212 is available in a fixed 3.3V/2.5V output voltage configuration. Other voltages are available; contact Microchip for details.

### Package Type

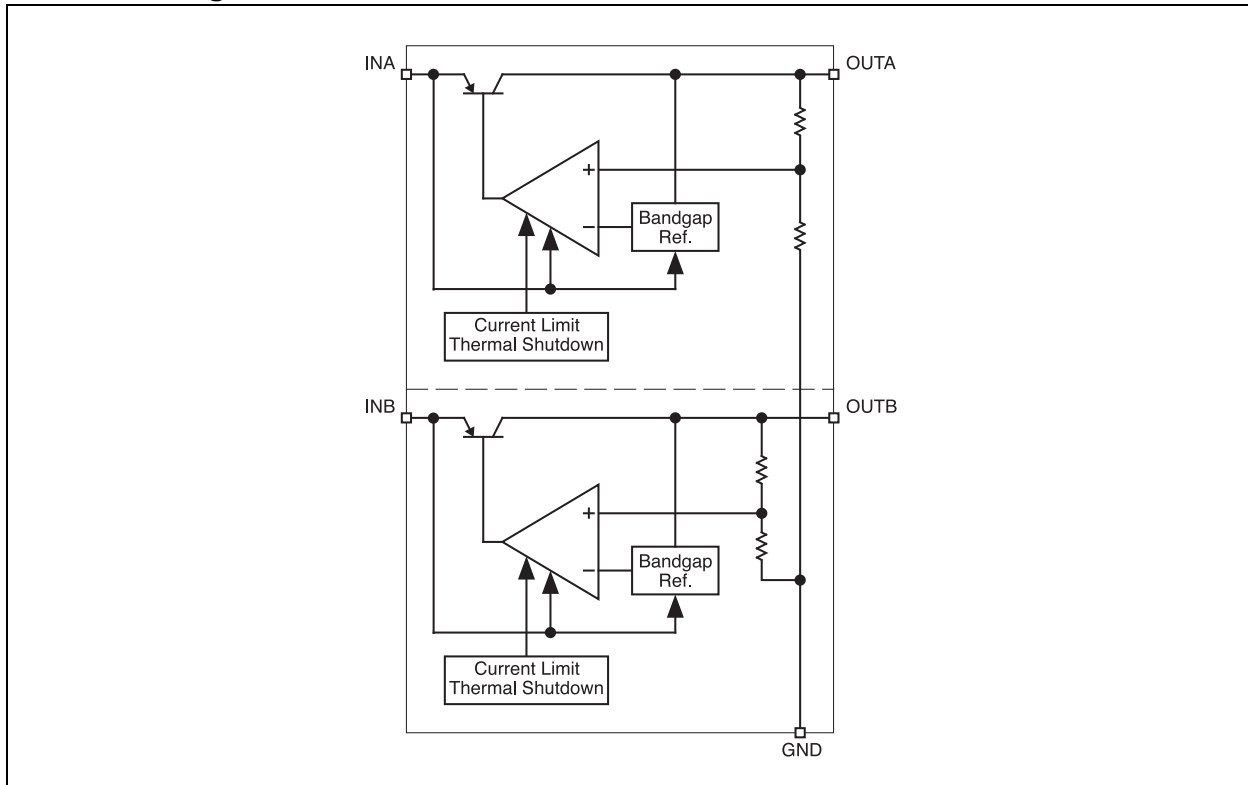


# MIC5212

## Typical Application Circuit



## Functional Diagram



## 1.0 ELECTRICAL CHARACTERISTICS

### Absolute Maximum Ratings †

Supply Input Voltage, ( $V_{IN}$  A or B) ..... –20V to +20V  
 Power Dissipation ..... Internally Limited

### Operating Ratings ††

Supply Input Voltage, ( $V_{IN}$ ) ..... +2.5V to +16V

† **Notice:** Exceeding the absolute maximum rating may damage the device.

†† **Notice:** The device is not guaranteed to function outside its operating rating.

### DC CHARACTERISTICS

**Electrical Characteristics:** Unless otherwise indicated, Regulator A and B  $V_{IN} = V_{OUT} + 1V$ ;  $I_L = 100 \mu A$ ;  $C_L = 4.7 \mu F$ ;  $T_J = +25^\circ C$ , bold values indicate  $-40^\circ C \leq T_J \leq +125^\circ C$ .

Parameters	Symbol	Min.	Typ.	Max.	Units	Conditions
Output Voltage Accuracy	$V_O$	–1	—	1	%	Variation from specified $V_{OUT}$
		–2	—	2	%	
Output Voltage Temperature Coefficient	$\Delta V_O/\Delta T$	—	<b>40</b>	—	ppm/ $^\circ C$	Note 1
Line Regulation	$\Delta V_O/V_O$	—	0.009	0.05	%/V	$V_{IN} = V_{OUT} + 1V$ to 16V
		—	—	<b>0.1</b>	%/V	
Load Regulation	$\Delta V_O/V_O$	—	0.05	0.7	%	$I_L = 0.1$ mA to 500 mA, Note 2
		—	—	<b>1</b>	%	
Dropout Voltage, Note 3 (per regulator)	$V_{IN} - V_O$	—	175	275	mV	$I_L = 150$ mA
		—	—	<b>350</b>	mV	
		—	350	500	mV	$I_L = 150$ mA
		—	—	<b>600</b>	mV	
Ground Pin Current, Note 4 (per regulator)	$I_{GND}$	—	1.5	2.5	mA	$I_L = 150$ mA
		—	—	<b>3.0</b>	mA	
		—	12	20	mA	$I_L = 150$ mA
		—	—	<b>25</b>	mA	
Ripple Rejection	PSRR	—	75	—	dB	$f = 120$ Hz, $I_L = 150$ mA
Current Limit	$I_{LIMIT}$	—	<b>750</b>	1000	mA	$V_{OUT} = 0V$
Spectral Noise Density	—	—	500	—	nV/ $\sqrt{Hz}$	$V_{OUT} = 2.5V$ , $I_{OUT} = 50$ mA, $C_{OUT} = 2.2 \mu F$

**Note 1:** Output voltage temperature coefficient is defined as the worst case voltage change divided by the total temperature range.

**2:** Regulation is measured at constant junction temperature using low duty cycle pulse testing. Parts are tested for load regulation in the load range from 0.1 mA to 500 mA. Changes in output voltage due to heating effects are covered by the thermal regulation specification.

**3:** Dropout voltage is defined as the input to output differential at which the output voltage drops 2% below its nominal value measured at 1V differential.

**4:** Ground pin current is the regulator quiescent current plus pass transistor base current. The total current drawn from the supply is the sum of the load current plus the ground pin current.

# MIC5212

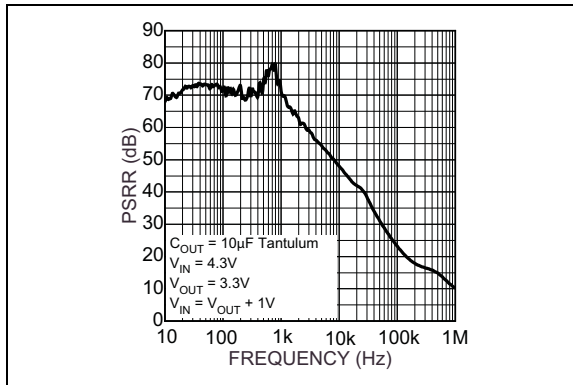
## TEMPERATURE SPECIFICATIONS (Note 1)

Parameters	Sym.	Min.	Typ.	Max.	Units	Conditions
<b>Temperature Ranges</b>						
Storage Temperature Range	$T_A$	-60	—	+150	°C	—
Lead Temperature	$T_J$	—	+260	—	°C	Soldering, 5 sec.
Junction Temperature	$T_J$	-40	—	+125	°C	—
<b>Package Thermal Resistances</b>						
Thermal Resistance, SOIC-8Ld	$\theta_{JC}$	—	20	—	°C/W	Note 2
	$\theta_{JA}$	—	63	—	°C/W	

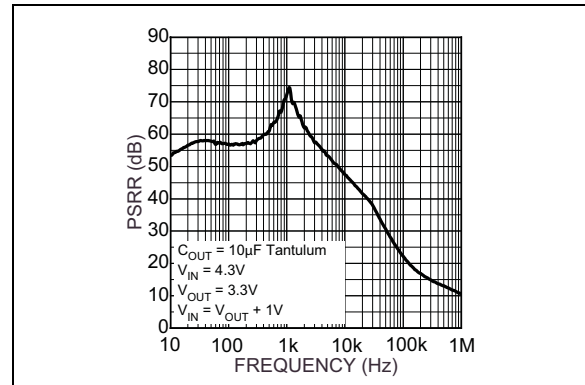
- Note 1:** The maximum allowable power dissipation is a function of ambient temperature, the maximum allowable junction temperature and the thermal resistance from junction to air (i.e.,  $T_A$ ,  $T_J$ ,  $\theta_{JA}$ ). Exceeding the maximum allowable power dissipation will cause the device operating junction temperature to exceed the maximum +125°C rating. Sustained junction temperatures above +125°C can impact the device reliability.
- 2:** Absolute maximum ratings indicate limits beyond which damage to the component may occur. Electrical specifications do not apply when operating the device outside of its operating ratings. The maximum allowable power dissipation is a function of the maximum junction temperature,  $T_{J(max)}$ , the junction-to-ambient thermal resistance,  $\theta_{JA}$ , and the ambient temperature,  $T_A$ . The maximum allowable power dissipation at any ambient temperature is calculated using:  $P_{D(max)} = (T_{J(max)} - T_A) \div \theta_{JA}$ . Exceeding the maximum allowable power dissipation will result in excessive die temperature, and the regulator will go into thermal shutdown. The  $\theta_{JA}$  of the 8-lead SOIC (M) is 63°C/W mounted on a PC board.

## 2.0 TYPICAL PERFORMANCE CURVES

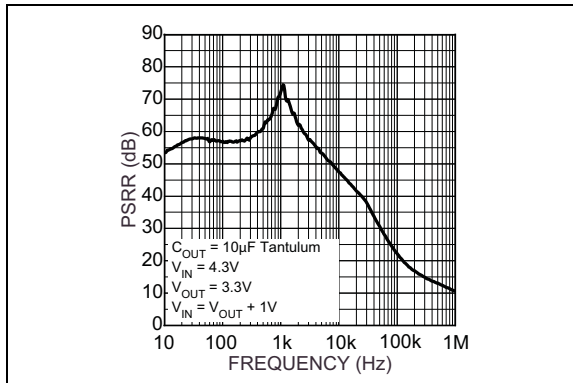
**Note:** The graphs and tables provided following this note are a statistical summary based on a limited number of samples and are provided for informational purposes only. The performance characteristics listed herein are not tested or guaranteed. In some graphs or tables, the data presented may be outside the specified operating range (e.g., outside specified power supply range) and therefore outside the warranted range.



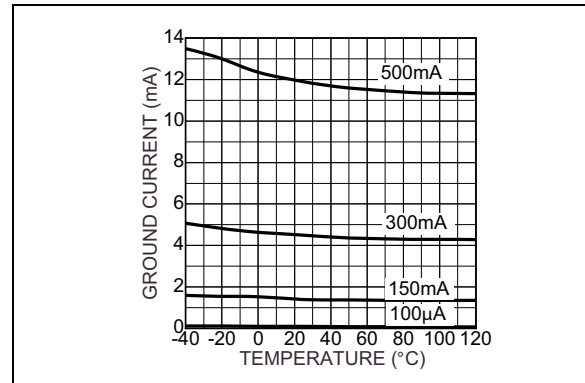
**FIGURE 2-1:** MIC5212-3.3 PSRR 150 mA Load.



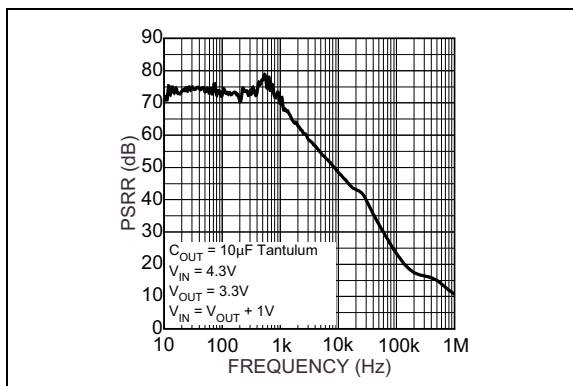
**FIGURE 2-4:** MIC5212-2.5 PSRR 500 mA Load.



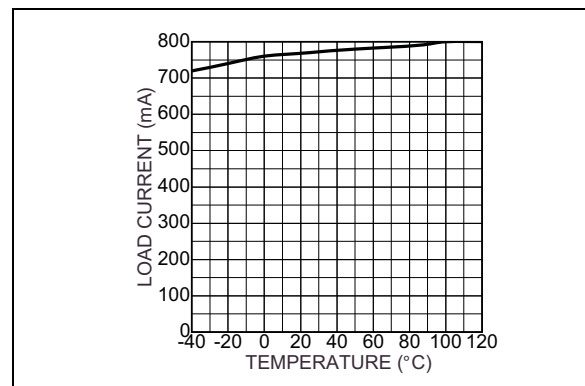
**FIGURE 2-2:** MIC5212-3.3 PSRR 500 mA Load.



**FIGURE 2-5:** Ground Current vs. Temperature.

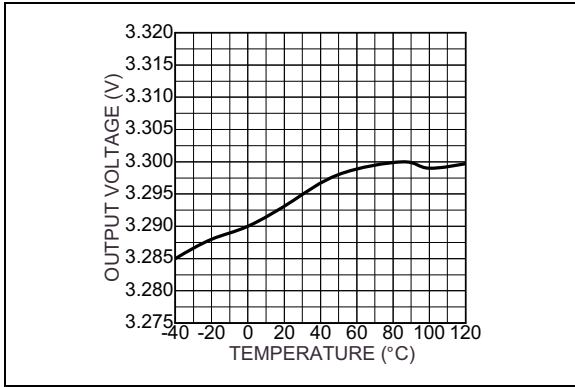


**FIGURE 2-3:** MIC5212-2.5 PSRR 150 mA Load.

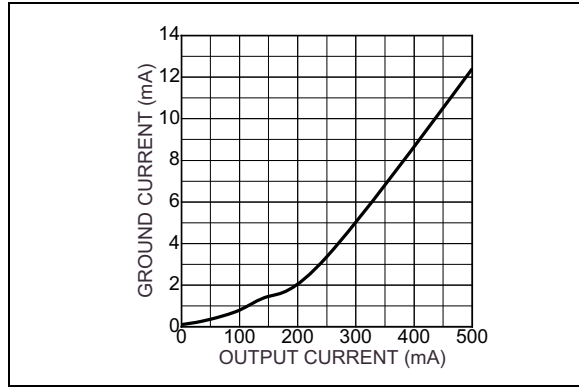


**FIGURE 2-6:** Short Circuit Current vs. Temperature.

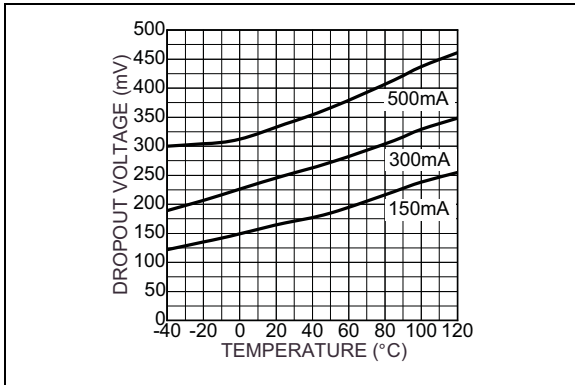
# MIC5212



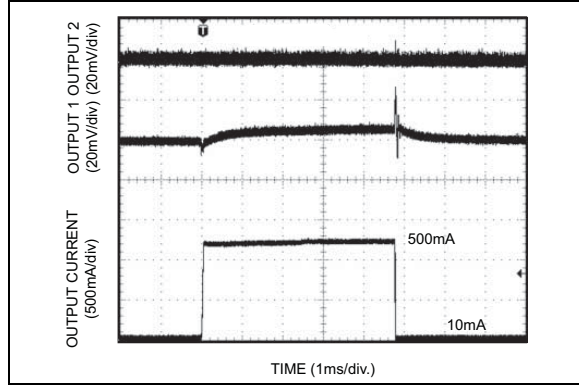
**FIGURE 2-7:** Output Voltage vs. Temperature.



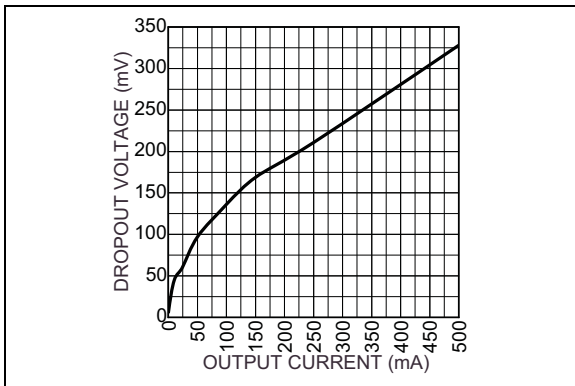
**FIGURE 2-10:** Ground Current vs. Load Current.



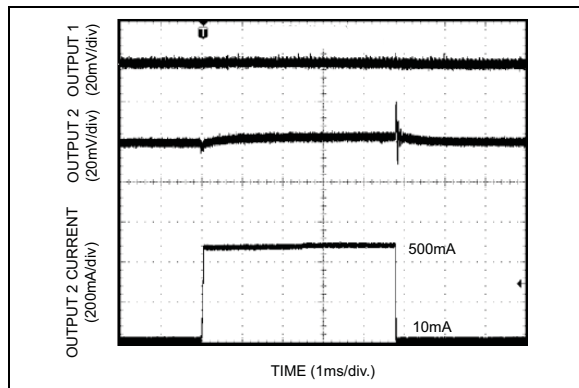
**FIGURE 2-8:** Dropout Voltage vs. Temperature.



**FIGURE 2-11:** Output 1 Load Transient Response.

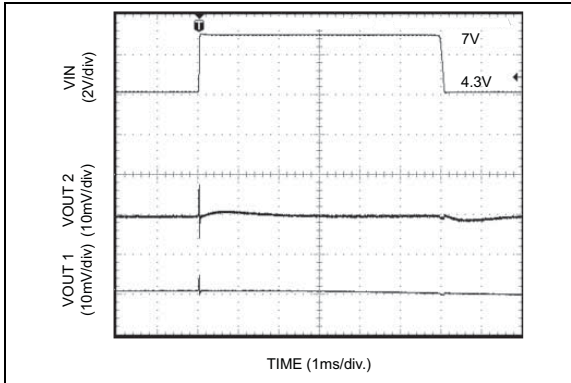
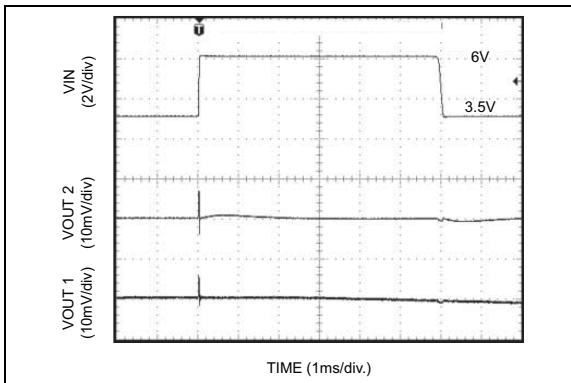
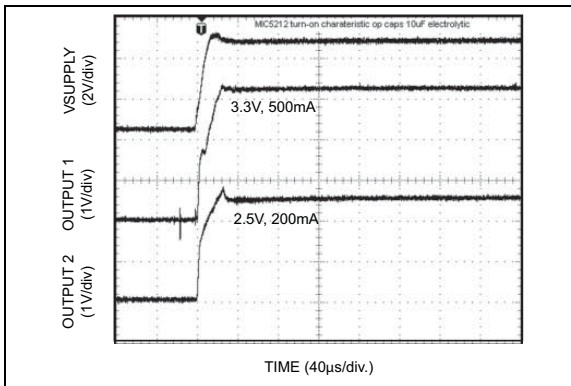


**FIGURE 2-9:** Dropout Voltage vs. Load Current.



**FIGURE 2-12:** Output 2 Load Transient Response.



**FIGURE 2-13:** *Line Transient Response.***FIGURE 2-14:** *Line Transient Response.***FIGURE 2-15:** *Turn-On Response.*

# MIC5212

---

## 3.0 PIN DESCRIPTIONS

The descriptions of the pins are listed in [Table 3-1](#).

**TABLE 3-1: PIN FUNCTION TABLE**

Pin Number	Pin Name	Description
1	OUTA	Regulator A Output.
2	INA	Regulator A Input.
3	INB	Regulator B Input.
4	OUTB	Regulator B Output.
5, 6, 7, 8	GND	Ground.

## 4.0 DEVICE OVERVIEW

### 4.1 Input Capacitor

A 1  $\mu\text{F}$  capacitor should be placed from IN to GND if there is more than 10 inches of wire between the input and the AC filter capacitor or if a battery is used as the input.

### 4.2 Output Capacitor

An output capacitor is required between OUT and GND to prevent oscillation. 1.0  $\mu\text{F}$  minimum is recommended. Larger values improve the regulator's transient response. The output capacitor value may be increased without limit.

The output capacitor should have an ESR (Effective Series Resistance) of about  $5\Omega$  or less and a resonant frequency above 1 MHz. Ultra-low-ESR capacitors may cause a low-amplitude oscillation and/or underdamped transient response. Most tantalum or aluminum electrolytic capacitors are adequate; film types will work, but are more expensive. Since many aluminum electrolytic capacitors have electrolytes that freeze at about  $-30^\circ\text{C}$ , solid tantalum capacitors are recommended for operation below  $-25^\circ\text{C}$ .

At lower values of output current, less output capacitance is required for output stability. The capacitor can be reduced to 0.47  $\mu\text{F}$  for current below 10 mA or 0.33  $\mu\text{F}$  for currents below 1 mA.

### 4.3 No-Load Stability

The MIC5212 will remain stable and in regulation with no load (other than the internal voltage divider) unlike many other voltage regulators. This is especially important in CMOS RAM keep-alive applications.

## 4.4 Dual-Supply Operation

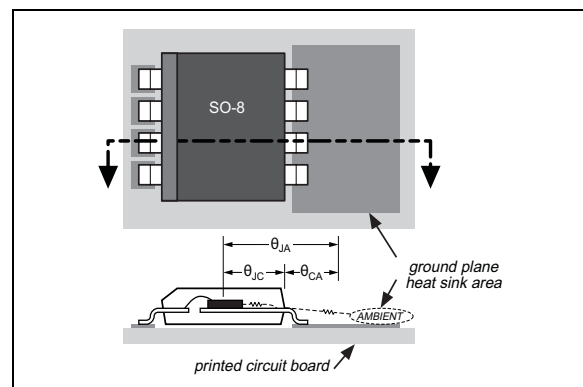
When used in dual supply systems where the regulator load is returned to a negative supply, the output voltage must be diode clamped to ground.

### 4.4.1 POWER SO-8 THERMAL CHARACTERISTICS

One of the secrets of the MIC5212's performance is its power SO-8 package featuring half the thermal resistance of a standard SO-8 package. Lower thermal resistance means more output current or higher input voltage for a given package size.

Lower thermal resistance is achieved by joining the four ground leads with the die attach paddle to create a single-unit electrical and thermal conductor. This concept has been used by MOSFET manufacturers for years, proving very reliable and cost effective for the user.

Thermal resistance consists of two main elements,  $\theta_{\text{JC}}$  (junction-to-case thermal resistance) and  $\theta_{\text{CA}}$  (case-to-ambient thermal resistance). See [Figure 4-1](#).  $\theta_{\text{JC}}$  is the resistance from the die to the leads of the package.  $\theta_{\text{CA}}$  is the resistance from the leads to the ambient air and it includes  $\theta_{\text{CS}}$  (case-to-sink thermal resistance) and  $\theta_{\text{SA}}$  (sink-to-ambient thermal resistance).



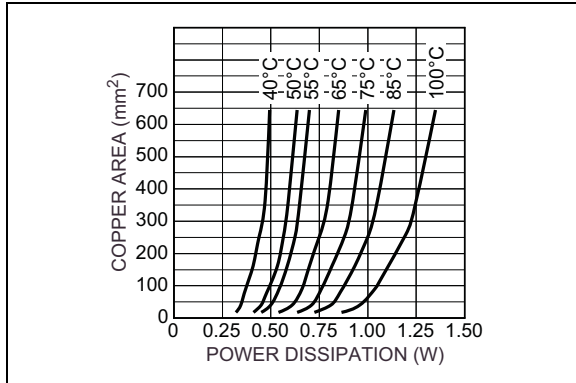
**FIGURE 4-1:** Thermal Resistance.

Using the power SO-8 reduces the  $\theta_{\text{JC}}$  dramatically and allows the user to reduce  $\theta_{\text{CA}}$ . The total thermal resistance,  $\theta_{\text{JA}}$  (junction-to-ambient thermal resistance) is the limiting factor in calculating the maximum power dissipation capability of the device. Typically, the power SO-8 has a  $\theta_{\text{JC}}$  of  $20^\circ\text{C}/\text{W}$ , this is significantly lower than the standard SO-8 which is typically  $75^\circ\text{C}/\text{W}$ .  $\theta_{\text{CA}}$  is reduced because pins 5 through 8 can now be soldered directly to a ground plane which significantly reduces the case-to-sink thermal resistance and sink to ambient thermal resistance.

These low dropout linear regulators are rated to a maximum junction temperature of  $125^\circ\text{C}$ . It is important not to exceed this maximum junction temperature

# MIC5212

during operation of the device. To prevent this maximum junction temperature from being exceeded, the appropriate ground plane heat sink must be used.



**FIGURE 4-2:** Copper Area vs. Power-SO Power Dissipation ( $\Delta T_{JA}$ ).

Figure 4-2 shows copper area versus power dissipation with each trace corresponding to a different temperature rise above ambient.

From these curves, the minimum area of copper necessary for the part to operate safely can be determined. The maximum allowable temperature rise must be calculated to determine operation along which curve.

#### EQUATION 4-1:

$$\Delta T = T_{J(max)} - T_{A(max)}$$

Where:

$$T_{J(max)} = 125^{\circ}\text{C}$$

$$T_{A(max)} = \text{Maximum ambient operating temperature}$$

For example, the maximum ambient temperature is  $50^{\circ}\text{C}$ , the  $\Delta T$  is determined as shown in Equation 4-2.

#### EQUATION 4-2:

$$\Delta T = 125^{\circ}\text{C} - 50^{\circ}\text{C}$$

$$\Delta T = 75^{\circ}\text{C}$$

Using Figure 4-2, the minimum amount of required copper can be determined based on the required power dissipation.

Power dissipation in a linear regulator is calculated as shown in Equation 4-3.

#### EQUATION 4-3:

$$P_D = (V_{IN1} - V_{OUT1}) \times I_{OUT1} + V_{IN1} \times I_{GND1} + (V_{IN2} - V_{OUT2}) \times I_{OUT2} + V_{IN2} \times I_{GND2}$$

With a common 5V input, a 3.3V, 300 mA output on LDO 1 and a 2.5V, 150 mA output on LDO 2, power dissipation is as follows:

#### EQUATION 4-4:

$$P_D = (5V - 3.3V) \times 300\text{mA} + 5V \times 5\text{mA} + (5V - 2.5V) \times 150\text{mA} + 5V \times 1.8\text{mA}$$

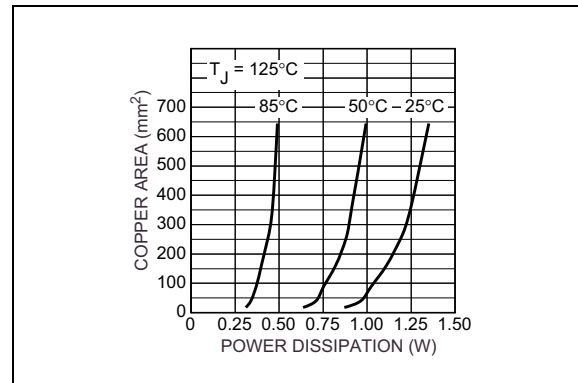
$$P_D = 0.919\text{W}$$

From Figure 4-2, the minimum amount of copper required to operate this application at a  $\Delta T$  of  $75^{\circ}\text{C}$  is  $500\text{ mm}^2$ .

#### 4.4.2 QUICK METHOD

Determine the power dissipation requirements for the design along with the maximum ambient temperature at which the device will be operated. Refer to Figure 4-3, which shows safe operating curves for three different ambient temperatures:  $25^{\circ}\text{C}$ ,  $50^{\circ}\text{C}$  and  $85^{\circ}\text{C}$ . From these curves, the minimum amount of copper can be determined by knowing the maximum power dissipation required. If the maximum ambient temperature is  $50^{\circ}\text{C}$  and the power dissipation is as above, 920 mW, the curve in Figure 4-3 shows that the required area of copper is  $500\text{ mm}^2$ .

The  $\theta_{JA}$  of this package is ideally  $63^{\circ}\text{C}/\text{W}$ , but it will vary depending upon the availability of copper ground plane to which it is attached.



**FIGURE 4-3:** Copper Area vs. Power-SO Power Dissipation ( $T_A$ ).

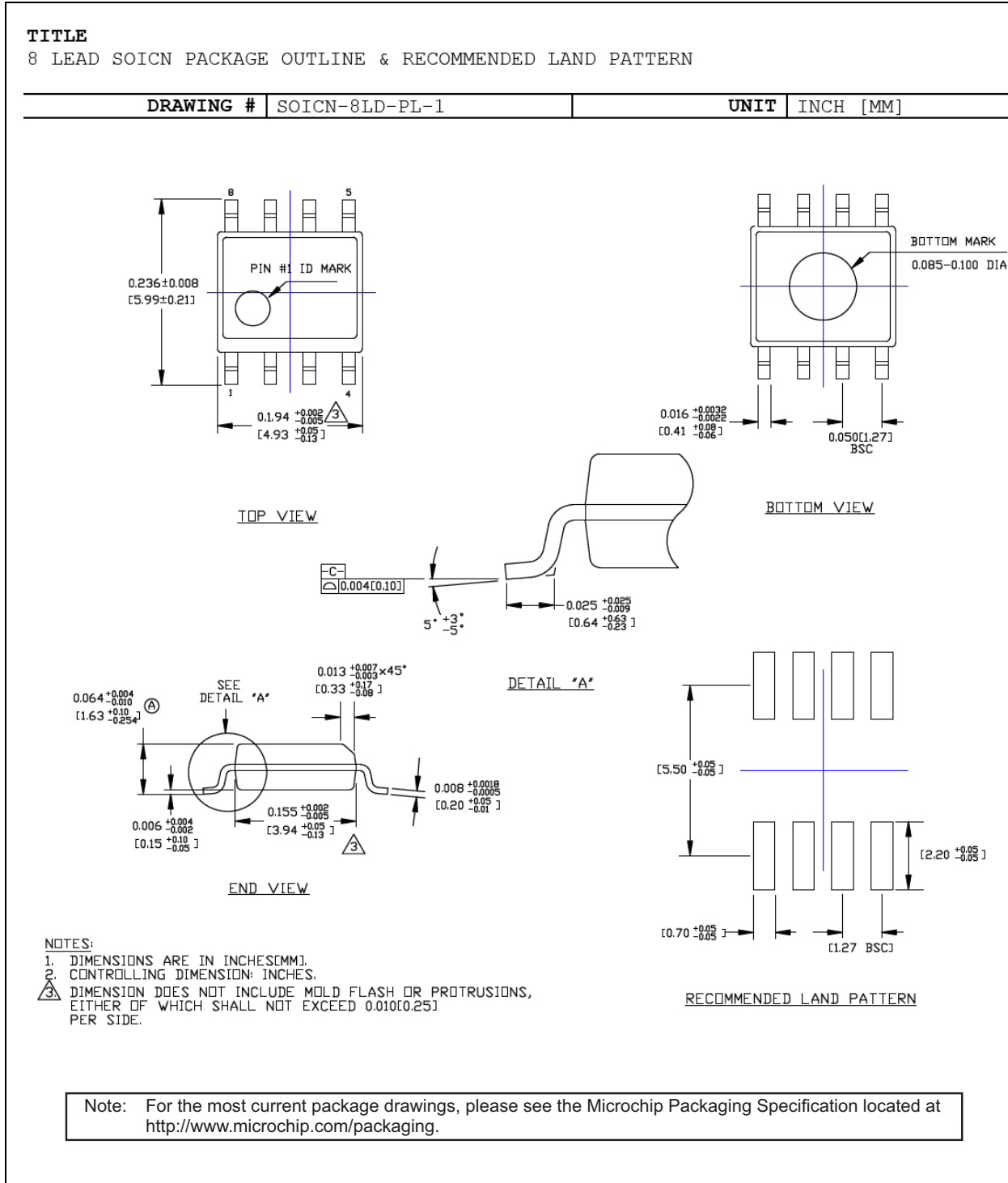
**5.0 PACKAGING INFORMATION****5.1 Package Marking Information**

<b>Legend:</b>	XX...X	Product code or customer-specific information
	Y	Year code (last digit of calendar year)
	YY	Year code (last 2 digits of calendar year)
	WW	Week code (week of January 1 is week '01')
	NNN	Alphanumeric traceability code
	(e3)	Pb-free JEDEC® designator for Matte Tin (Sn)
	*	This package is Pb-free. The Pb-free JEDEC designator (e3) can be found on the outer packaging for this package.
	•, ▲, ▼	Pin one index is identified by a dot, delta up, or delta down (triangle mark).
<b>Note:</b>	In the event the full Microchip part number cannot be marked on one line, it will be carried over to the next line, thus limiting the number of available characters for customer-specific information. Package may or may not include the corporate logo.	
	Underbar ( _ ) and/or Overbar ( ¯ ) symbol may not be to scale.	



# MIC5212

## 8-Lead SOICN Package Outline & Recommended Land Pattern



**APPENDIX A: REVISION HISTORY****Revision A (June 2017)**

- Converted Micrel document MIC5212 to Microchip data sheet template DS20005774A.
- Minor grammatical text changes throughout.

# MIC5212

---

NOTES:

**PRODUCT IDENTIFICATION SYSTEM**

To order or obtain information, e.g., on pricing or delivery, contact your local Microchip representative or sales office.

<b>PART NO.</b>	<b>-X</b>	<b>X</b>	<b>X</b>	<b>XX</b>	<b>-XX</b>
<b>Device</b>	<b>Fixed Output Voltage</b>	<b>Accuracy</b>	<b>Temperature Range</b>	<b>Package</b>	<b>Media Type</b>
<b>Device:</b>	MIC5212:	Dual 500 mA LDO Regulator			
<b>Fixed Output Voltage:</b>	S	= 3.3V/2.5V			
<b>Accuracy</b>	J	= 1.0%			
<b>Temperature Range:</b>	Y	= -40°C to +125°C (RoHS Compliant)			
<b>Package:</b>	M	= 8-Lead SOIC			
<b>Media Type:</b>	TR	= 2,500/Reel			
	<blank>	= 95/Tube			

**Examples:**

- a) MIC5212-SJYM: Dual 500 mA LDO Regulator, 3.3V/2.5V Output Voltage, 1% Accuracy, -40°C to +125°C Temperature Range, 8-Lead SOIC, 95/Tube
- b) MIC5212-SJYM-TR: Dual 500 mA LDO Regulator, 3.3V/2.5V Output Voltage, 1% Accuracy, -40°C to +125°C Temperature Range, 8-Lead SOIC, 2,500/Reel

**Note 1:** Tape and Reel identifier only appears in the catalog part number description. This identifier is used for ordering purposes and is not printed on the device package. Check with your Microchip Sales Office for package availability with the Tape and Reel option.

# MIC5212

---

NOTES:



**Note the following details of the code protection feature on Microchip devices:**

- Microchip products meet the specification contained in their particular Microchip Data Sheet.
- Microchip believes that its family of products is one of the most secure families of its kind on the market today, when used in the intended manner and under normal conditions.
- There are dishonest and possibly illegal methods used to breach the code protection feature. All of these methods, to our knowledge, require using the Microchip products in a manner outside the operating specifications contained in Microchip's Data Sheets. Most likely, the person doing so is engaged in theft of intellectual property.
- Microchip is willing to work with the customer who is concerned about the integrity of their code.
- Neither Microchip nor any other semiconductor manufacturer can guarantee the security of their code. Code protection does not mean that we are guaranteeing the product as “unbreakable.”

Code protection is constantly evolving. We at Microchip are committed to continuously improving the code protection features of our products. Attempts to break Microchip's code protection feature may be a violation of the Digital Millennium Copyright Act. If such acts allow unauthorized access to your software or other copyrighted work, you may have a right to sue for relief under that Act.

Information contained in this publication regarding device applications and the like is provided only for your convenience and may be superseded by updates. It is your responsibility to ensure that your application meets with your specifications. MICROCHIP MAKES NO REPRESENTATIONS OR WARRANTIES OF ANY KIND WHETHER EXPRESS OR IMPLIED, WRITTEN OR ORAL, STATUTORY OR OTHERWISE, RELATED TO THE INFORMATION, INCLUDING BUT NOT LIMITED TO ITS CONDITION, QUALITY, PERFORMANCE, MERCHANTABILITY OR FITNESS FOR PURPOSE. Microchip disclaims all liability arising from this information and its use. Use of Microchip devices in life support and/or safety applications is entirely at the buyer's risk, and the buyer agrees to defend, indemnify and hold harmless Microchip from any and all damages, claims, suits, or expenses resulting from such use. No licenses are conveyed, implicitly or otherwise, under any Microchip intellectual property rights unless otherwise stated.

*Microchip received ISO/TS-16949:2009 certification for its worldwide headquarters, design and wafer fabrication facilities in Chandler and Tempe, Arizona; Gresham, Oregon and design centers in California and India. The Company's quality system processes and procedures are for its PIC® MCUs and dsPIC® DSCs, KEELOQ® code hopping devices, Serial EEPROMs, microperipherals, nonvolatile memory and analog products. In addition, Microchip's quality system for the design and manufacture of development systems is ISO 9001:2000 certified.*

**QUALITY MANAGEMENT SYSTEM  
CERTIFIED BY DNV  
= ISO/TS 16949 =**

**Trademarks**

The Microchip name and logo, the Microchip logo, AnyRate, AVR, AVR logo, AVR Freaks, BeaconThings, BitCloud, CryptoMemory, CryptoRF, dsPIC, FlashFlex, flexPWR, Helder, JukeBlox, KEELOQ, KEELOQ logo, Klear, LANCheck, LINK MD, maXStylus, maXTouch, MediaLB, megaAVR, MOST, MOST logo, MPLAB, OptoLyzer, PIC, picoPower, PICSTART, PIC32 logo, Prochip Designer, QTouch, RightTouch, SAM-BA, SpyNIC, SST, SST Logo, SuperFlash, tinyAVR, UNI/O, and XMEGA are registered trademarks of Microchip Technology Incorporated in the U.S.A. and other countries.

ClockWorks, The Embedded Control Solutions Company, EtherSynch, Hyper Speed Control, HyperLight Load, IntelliMOS, mTouch, Precision Edge, and Quiet-Wire are registered trademarks of Microchip Technology Incorporated in the U.S.A.

Adjacent Key Suppression, AKS, Analog-for-the-Digital Age, Any Capacitor, AnyIn, AnyOut, BodyCom, chipKIT, chipKIT logo, CodeGuard, CryptoAuthentication, CryptoCompanion, CryptoController, dsPICDEM, dsPICDEM.net, Dynamic Average Matching, DAM, ECAN, EtherGREEN, In-Circuit Serial Programming, ICSP, Inter-Chip Connectivity, JitterBlocker, KlearNet, KlearNet logo, Mindi, MiWi, motorBench, MPASM, MPF, MPLAB Certified logo, MPLIB, MPLINK, MultiTRAK, NetDetach, Omniscient Code Generation, PICDEM, PICDEM.net, PICKit, PICTail, PureSilicon, QMatrix, RightTouch logo, REAL ICE, Ripple Blocker, SAM-ICE, Serial Quad I/O, SMART-I.S., SQI, SuperSwitcher, SuperSwitcher II, Total Endurance, TSHARC, USBCheck, VariSense, ViewSpan, WiperLock, Wireless DNA, and ZENA are trademarks of Microchip Technology Incorporated in the U.S.A. and other countries.

SQTP is a service mark of Microchip Technology Incorporated in the U.S.A.

Silicon Storage Technology is a registered trademark of Microchip Technology Inc. in other countries.

GestIC is a registered trademark of Microchip Technology Germany II GmbH & Co. KG, a subsidiary of Microchip Technology Inc., in other countries.

All other trademarks mentioned herein are property of their respective companies.

© 2017, Microchip Technology Incorporated, All Rights Reserved.  
ISBN: 978-1-5224-1786-6



# MICROCHIP

## Worldwide Sales and Service

### AMERICAS

**Corporate Office**  
2355 West Chandler Blvd.  
Chandler, AZ 85224-6199  
Tel: 480-792-7200  
Fax: 480-792-7277  
Technical Support:  
<http://www.microchip.com/support>  
Web Address:  
[www.microchip.com](http://www.microchip.com)

**Atlanta**  
Duluth, GA  
Tel: 678-957-9614  
Fax: 678-957-1455

**Austin, TX**  
Tel: 512-257-3370

**Boston**  
Westborough, MA  
Tel: 774-760-0087  
Fax: 774-760-0088

**Chicago**  
Itasca, IL  
Tel: 630-285-0071  
Fax: 630-285-0075

**Dallas**  
Addison, TX  
Tel: 972-818-7423  
Fax: 972-818-2924

**Detroit**  
Novi, MI  
Tel: 248-848-4000

**Houston, TX**  
Tel: 281-894-5983

**Indianapolis**  
Noblesville, IN  
Tel: 317-773-8323  
Fax: 317-773-5453  
Tel: 317-536-2380

**Los Angeles**  
Mission Viejo, CA  
Tel: 949-462-9523  
Fax: 949-462-9608  
Tel: 951-273-7800

**Raleigh, NC**  
Tel: 919-844-7510

**New York, NY**  
Tel: 631-435-6000

**San Jose, CA**  
Tel: 408-735-9110  
Tel: 408-436-4270

**Canada - Toronto**  
Tel: 905-695-1980  
Fax: 905-695-2078

### ASIA/PACIFIC

**Asia Pacific Office**  
Suites 3707-14, 37th Floor  
Tower 6, The Gateway  
Harbour City, Kowloon

**Hong Kong**  
Tel: 852-2943-5100  
Fax: 852-2401-3431

**Australia - Sydney**  
Tel: 61-2-9868-6733  
Fax: 61-2-9868-6755

**China - Beijing**  
Tel: 86-10-8569-7000  
Fax: 86-10-8528-2104

**China - Chengdu**  
Tel: 86-28-8665-5511  
Fax: 86-28-8665-7889

**China - Chongqing**  
Tel: 86-23-8980-9588  
Fax: 86-23-8980-9500

**China - Dongguan**  
Tel: 86-769-8702-9880

**China - Guangzhou**  
Tel: 86-20-8755-8029

**China - Hangzhou**  
Tel: 86-571-8792-8115  
Fax: 86-571-8792-8116

**China - Hong Kong SAR**  
Tel: 852-2943-5100  
Fax: 852-2401-3431

**China - Nanjing**  
Tel: 86-25-8473-2460  
Fax: 86-25-8473-2470

**China - Qingdao**  
Tel: 86-532-8502-7355  
Fax: 86-532-8502-7205

**China - Shanghai**  
Tel: 86-21-3326-8000  
Fax: 86-21-3326-8021

**China - Shenyang**  
Tel: 86-24-2334-2829  
Fax: 86-24-2334-2393

**China - Shenzhen**  
Tel: 86-755-8864-2200  
Fax: 86-755-8203-1760

**China - Wuhan**  
Tel: 86-27-5980-5300  
Fax: 86-27-5980-5118

**China - Xian**  
Tel: 86-29-8833-7252  
Fax: 86-29-8833-7256

### ASIA/PACIFIC

**China - Xiamen**  
Tel: 86-592-2388138  
Fax: 86-592-2388130

**China - Zhuhai**  
Tel: 86-756-3210040  
Fax: 86-756-3210049

**India - Bangalore**  
Tel: 91-80-3090-4444  
Fax: 91-80-3090-4123

**India - New Delhi**  
Tel: 91-11-4160-8631  
Fax: 91-11-4160-8632

**India - Pune**  
Tel: 91-20-3019-1500

**Japan - Osaka**  
Tel: 81-6-6152-7160  
Fax: 81-6-6152-9310

**Japan - Tokyo**  
Tel: 81-3-6880-3770  
Fax: 81-3-6880-3771

**Korea - Daegu**  
Tel: 82-53-744-4301  
Fax: 82-53-744-4302

**Korea - Seoul**  
Tel: 82-2-554-7200  
Fax: 82-2-558-5932 or  
82-2-558-5934

**Malaysia - Kuala Lumpur**  
Tel: 60-3-6201-9857  
Fax: 60-3-6201-9859

**Malaysia - Penang**  
Tel: 60-4-227-8870  
Fax: 60-4-227-4068

**Philippines - Manila**  
Tel: 63-2-634-9065  
Fax: 63-2-634-9069

**Singapore**  
Tel: 65-6334-8870  
Fax: 65-6334-8850

**Taiwan - Hsin Chu**  
Tel: 886-3-5778-366  
Fax: 886-3-5770-955

**Taiwan - Kaohsiung**  
Tel: 886-7-213-7830

**Taiwan - Taipei**  
Tel: 886-2-2508-8600  
Fax: 886-2-2508-0102

**Thailand - Bangkok**  
Tel: 66-2-694-1351  
Fax: 66-2-694-1350

### EUROPE

**Austria - Wels**  
Tel: 43-7242-2244-39  
Fax: 43-7242-2244-393

**Denmark - Copenhagen**  
Tel: 45-4450-2828  
Fax: 45-4485-2829

**Finland - Espoo**  
Tel: 358-9-4520-820

**France - Paris**  
Tel: 33-1-69-53-63-20  
Fax: 33-1-69-30-90-79

**France - Saint Cloud**  
Tel: 33-1-30-60-70-00

**Germany - Garching**  
Tel: 49-8931-9700

**Germany - Haan**  
Tel: 49-2129-3766400

**Germany - Heilbronn**  
Tel: 49-7131-67-3636

**Germany - Karlsruhe**  
Tel: 49-721-625370

**Germany - Munich**  
Tel: 49-89-627-144-0  
Fax: 49-89-627-144-44

**Germany - Rosenheim**  
Tel: 49-8031-354-560

**Israel - Ra'anana**  
Tel: 972-9-744-7705

**Italy - Milan**  
Tel: 39-0331-742611  
Fax: 39-0331-466781

**Italy - Padova**  
Tel: 39-049-7625286

**Netherlands - Drunen**  
Tel: 31-416-690399  
Fax: 31-416-690340

**Norway - Trondheim**  
Tel: 47-7289-7561

**Poland - Warsaw**  
Tel: 48-22-3325737

**Romania - Bucharest**  
Tel: 40-21-407-87-50

**Spain - Madrid**  
Tel: 34-91-708-08-90  
Fax: 34-91-708-08-91

**Sweden - Gothenberg**  
Tel: 46-31-704-60-40

**Sweden - Stockholm**  
Tel: 46-8-5090-4654

**UK - Wokingham**  
Tel: 44-118-921-5800  
Fax: 44-118-921-5820



## OUR CERTIFICATE

DiGi provide top-quality products and perfect service for customer worldwide through standardization, technological innovation and continuous improvement. DiGi through third-party certification, we stricly control the quality of products and services. Welcome your RFQ to

Email: [Info@DiGi-Electronics.com](mailto:Info@DiGi-Electronics.com)



Tel: +00 852-30501935

RFQ Email: [Info@DiGi-Electronics.com](mailto:Info@DiGi-Electronics.com)

DiGi is a global authorized distributor of electronic components.