

MIC94080YFT-TR Datasheet

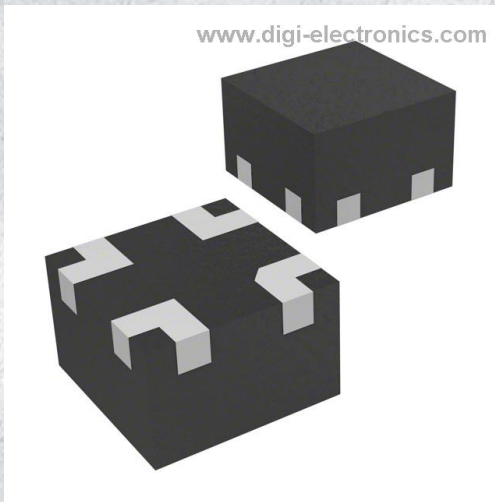

<https://www.DiGi-Electronics.com>

DiGi Electronics Part Number	MIC94080YFT-TR-DG
Manufacturer	Microchip Technology
Manufacturer Product Number	MIC94080YFT-TR
Description	IC PWR SWITCH P-CHAN 1:1 4TMLF
Detailed Description	Power Switch/Driver 1:1 P-Channel 2A 4-TMLF® (0.85x0.85)



Tel: +00 852-30501935

RFQ Email: Info@DiGi-Electronics.com

DiGi is a global authorized distributor of electronic components.

Purchase and inquiry

Manufacturer Product Number:

MIC94080YFT-TR

Series:

-

Switch Type:

General Purpose

Ratio - Input:Output:

1:1

Output Type:

P-Channel

Voltage - Load:

1.7V ~ 5.5V

Current - Output (Max):

2A

Input Type:

Non-Inverting

Fault Protection:

-

Mounting Type:

Surface Mount

Package / Case:

4-UFDN, 4-TMLF®

Manufacturer:

Microchip Technology

Product Status:

Active

Number of Outputs:

1

Output Configuration:

High Side

Interface:

On/Off

Voltage - Supply (Vcc/Vdd):

Not Required

Rds On (Typ):

67mOhm

Features:

-

Operating Temperature:

-40°C ~ 125°C (TJ)

Supplier Device Package:

4-TMLF® (0.85x0.85)

Base Product Number:

MIC94080

Environmental & Export classification

RoHS Status:

ROHS3 Compliant

REACH Status:

REACH Unaffected

HTSUS:

8542.39.0001

Moisture Sensitivity Level (MSL):

1 (Unlimited)

ECCN:

EAR99



MIC94080/1/2/3/4/5

**67 mΩ $R_{DS(ON)}$ 2A High-Side Load Switch
in 0.85 mm x 0.85 mm FTDFN Package**

Features

- Space-Saving 0.85 mm x 0.85 mm 4-Lead FTDFN Package
- Input Voltage Range: 1.7V to 5.5V
- 2A Continuous Operating Current
- 67 mΩ $R_{DS(ON)}$
- Internal Level Shift for CMOS/TTL Control Logic
- Ultra-Low Quiescent Current
- Micropower Shutdown Current
- Soft-Start: MIC94082/3 (800 μs), MIC94084/5 (120 μs)
- Load Discharge Circuit: MIC94081, MIC94083, MIC94085
- Ultra-Fast Turn-Off Time
- -40°C to +125°C Junction Operating Temperature

Applications

- Cellular Phones
- Portable Navigation Devices (PND)
- Personal Media Players (PMP)
- Ultra-Mobile PCs
- Portable Instrumentation
- Other Portable Applications
- PDAs
- GPS Modules
- Industrial and Datacom Equipment

Package Type

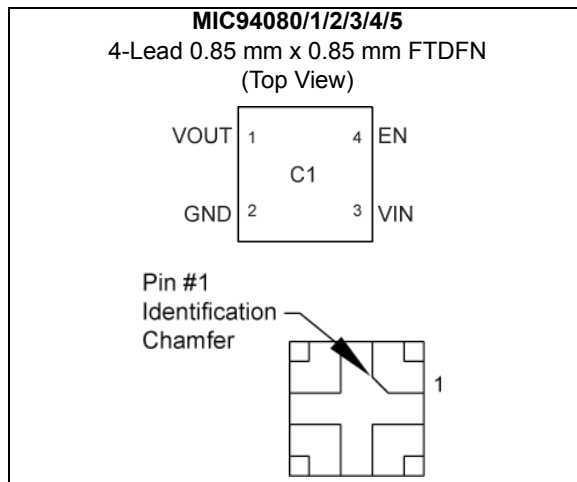

General Description

The MIC94080/1/2/3/4/5 is a family of high-side load switches designed to operate from 1.7V to 5.5V input voltage. The load switch pass element is an internal 67 mΩ $R_{DS(ON)}$ P-Channel MOSFET that enables the device to support up to 2A of continuous current. Additionally, the load switch supports 1.5V logic level control and shutdown features in a tiny 0.85 mm x 0.85 mm 4-lead FTDFN package.

The MIC94080 and MIC94081 feature rapid turn on. The MIC94082 and MIC94083 provide a slew rate controlled soft-start turn-on of 800 μs, while the MIC94084 and MIC94085 provide a slew rate controlled soft-start turn-on of 120 μs. The soft-start feature is provided to prevent an in-rush current event from pulling down the input supply voltage.

The MIC94081, MIC94083, and MIC94085 feature an active load discharge circuit which switches in a 250Ω load when the switch is disabled to automatically discharge a capacitive load.

An active pull-down on the enable input keeps the MIC94080/1/2/3/4/5 in a default OFF state until the enable pin is pulled above 1.25V. Internal level shift circuitry allows low voltage logic signals to switch higher supply voltages. The enable voltage can be as high as 5.5V and is not limited by the input voltage.

The MIC94080/1/2/3/4/5 operating voltage range makes them ideal for Lithium ion and NiMH/NiCad/Alkaline battery powered systems, as well as non-battery powered applications. The devices provide low quiescent current and low shutdown current to maximize battery life.

MIC94080/1/2/3/4/5

Typical Application Circuits

MIC94080 (Ultra-Fast Turn-On)
MIC94082 (800 μ s Soft-Start)
MIC94084 (120 μ s Soft-Start)

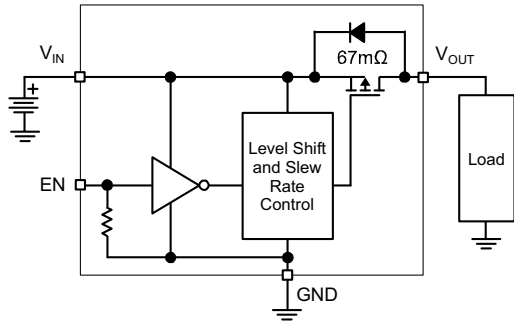

MIC94081 (Ultra-Fast Turn-On w/ Auto-Discharge)
MIC94083 (800 μ s Soft-Start w/ Auto-Discharge)
MIC94085 (120 μ s Soft-Start w/ Auto-Discharge)

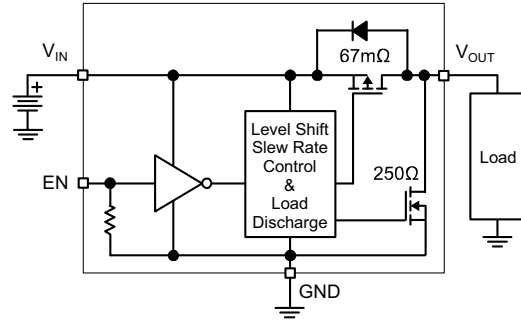

MIC94080/1/2/3/4/5

1.0 ELECTRICAL CHARACTERISTICS

Absolute Maximum Ratings †

Input Voltage (V_{IN})	+6V
Enable Voltage (V_{EN})	+6V
Continuous Drain Current (I_D) (Note 1)	
$T_A = +25^\circ\text{C}$	$\pm 2.0\text{A}$
$T_A = +85^\circ\text{C}$	$\pm 1.5\text{A}$
Pulsed Drain Current (I_{DP}) (Note 2)	$\pm 6.0\text{A}$
Continuous Diode Current (I_S) (Note 3)	-50 mA
Storage Temperature (T_S)	-55°C to $+150^\circ\text{C}$
ESD Rating (HBM, Note 4)	3 kV

Operating Ratings ††

Input Voltage (V_{IN})	+1.7V to +5.5V
Junction Temperature Range (T_J)	-40°C to $+125^\circ\text{C}$
Package Thermal Resistance	
4-Ld FTDFN 0.85 mm x 0.85 mm (θ_{JA})	140°C/W
4-Ld FTDFN 0.85 mm x 0.85 mm (θ_{JC})	85°C/W

† Notice: Stresses above those listed under “Absolute Maximum Ratings” may cause permanent damage to the device. This is a stress rating only and functional operation of the device at those or any other conditions above those indicated in the operational sections of this specification is not intended. Exposure to maximum rating conditions for extended periods may affect device reliability.

†† Notice: The device is not guaranteed to function outside its operating ratings.

Note 1: With thermal contact to PCB. See Thermal Considerations section.

2: Pulse width <300 μs with <2% duty cycle.

3: Continuous body diode current conduction (reverse conduction, i.e. V_{OUT} to V_{IN}) is not recommended.

4: Devices are ESD sensitive. Handling precautions recommended. Human body model, 1.5 k Ω in series with 100 pF.

MIC94080/1/2/3/4/5

ELECTRICAL CHARACTERISTICS

Electrical Characteristics: $T_A = +25^\circ\text{C}$, **bold** values indicate $-40^\circ\text{C} \leq T_A \leq +85^\circ\text{C}$, unless noted.

Parameter	Sym.	Min.	Typ.	Max.	Units	Conditions
Enable Threshold Voltage	V_{EN_TH}	0.4	—	1.25	V	$V_{IN} = 1.7\text{V to } 4.5\text{V}$, $I_D = -250\ \mu\text{A}$
Quiescent Current	I_Q	—	0.1	1	μA	$V_{IN} = V_{EN} = 5.5\text{V}$, $I_D = \text{OPEN}$ Measured on V_{IN} MIC94080/1
		—	8	15		$V_{IN} = V_{EN} = 5.5\text{V}$, $I_D = \text{OPEN}$ Measured on V_{IN} MIC94082/3/4/5
Enable Input Current	I_{EN}	—	2.8	4	μA	$V_{IN} = V_{EN} = 5.5\text{V}$, $I_D = \text{OPEN}$
Quiescent Current (Shutdown)	I_{SHUT-Q}	—	0.02	1	μA	$V_{IN} = +5.5\text{V}$, $V_{EN} = 0\text{V}$, $I_D = \text{OPEN}$ Measured on V_{IN} , Note 1
OFF State Leakage Current	$I_{SHUT-SWITCH}$	—	0.02	1	μA	$V_{IN} = +5.5\text{V}$, $V_{EN} = 0\text{V}$, $I_D = \text{SHORT}$ Measured on V_{IN} , Note 1
P-Channel Drain-to-Source ON Resistance	$R_{DS(ON)}$	—	67	115	$\text{m}\Omega$	$V_{IN} = +5.0\text{V}$, $I_D = -100\ \text{mA}$, $V_{EN} = 1.5\text{V}$
		—	70	130		$V_{IN} = +4.5\text{V}$, $I_D = -100\ \text{mA}$, $V_{EN} = 1.5\text{V}$
		—	80	165		$V_{IN} = +3.6\text{V}$, $I_D = -100\ \text{mA}$, $V_{EN} = 1.5\text{V}$
		—	110	225		$V_{IN} = +2.5\text{V}$, $I_D = -100\ \text{mA}$, $V_{EN} = 1.5\text{V}$
		—	175	350		$V_{IN} = +1.8\text{V}$, $I_D = -100\ \text{mA}$, $V_{EN} = 1.5\text{V}$
		—	200	375		$V_{IN} = +1.7\text{V}$, $I_D = -100\ \text{mA}$, $V_{EN} = 1.5\text{V}$
Turn-Off Resistance	$R_{SHUTDOWN}$	—	250	400	Ω	$V_{IN} = +3.6\text{V}$, $I_{TEST} = 1\ \text{mA}$, $V_{EN} = 0\text{V}$ MIC94081/3/5
Dynamic Electrical Characteristics						
Turn-On Delay	t_{ON_DLY}	—	0.4	1.5	μs	$V_{IN} = +3.6\text{V}$, $I_D = -100\ \text{mA}$, $V_{EN} = 1.5\text{V}$ MIC94080, MIC94081
		200	600	1500		$V_{IN} = +3.6\text{V}$, $I_D = -100\ \text{mA}$, $V_{EN} = 1.5\text{V}$ MIC94082, MIC94083
		65	110	165		$V_{IN} = +3.6\text{V}$, $I_D = -100\ \text{mA}$, $V_{EN} = 1.5\text{V}$ MIC94084, MIC94085
Turn-On Rise Time	t_{ON_RISE}	—	0.4	1.5	μs	$V_{IN} = +3.6\text{V}$, $I_D = -100\ \text{mA}$, $V_{EN} = 1.5\text{V}$ MIC94080, MIC94081
		400	800	1500		$V_{IN} = +3.6\text{V}$, $I_D = -100\ \text{mA}$, $V_{EN} = 1.5\text{V}$ MIC94082, MIC94083
		65	120	175		$V_{IN} = +3.6\text{V}$, $I_D = -100\ \text{mA}$, $V_{EN} = 1.5\text{V}$ MIC94084, MIC94085
Turn-Off Delay Time	t_{OFF_DLY}	—	60	200	ns	$V_{IN} = +3.6\text{V}$, $I_D = -100\ \text{mA}$, $V_{EN} = 0\text{V}$
Turn-Off Fall Time	t_{OFF_FALL}	—	20	100	ns	$V_{IN} = +3.6\text{V}$, $I_D = -100\ \text{mA}$, $V_{EN} = 0\text{V}$

Note 1: Measured on the MIC94080YFT.

MIC94080/1/2/3/4/5

TEMPERATURE SPECIFICATIONS

Parameters	Sym.	Min.	Typ.	Max.	Units	Conditions
Temperature Ranges						
Junction Temperature Range	T_J	-40	—	+125	°C	—
Storage Temperature Range	T_S	-55	—	+150	°C	—
Package Thermal Resistances						
Thermal Resistance, 4-Ld FTDFN 0.85 mm x 0.85 mm	θ_{JA}	—	140	—	°C/W	—
Thermal Resistance, 4-Ld FTDFN 0.85 mm x 0.85 mm	θ_{JC}	—	85	—	°C/W	—

Note 1: The maximum allowable power dissipation is a function of ambient temperature, the maximum allowable junction temperature and the thermal resistance from junction to air (i.e., T_A , T_J , θ_{JA}). Exceeding the maximum allowable power dissipation will cause the device operating junction temperature to exceed the maximum +125°C rating. Sustained junction temperatures above +125°C can impact the device reliability.

MIC94080/1/2/3/4/5

2.0 TYPICAL PERFORMANCE CURVES

Note: The graphs and tables provided following this note are a statistical summary based on a limited number of samples and are provided for informational purposes only. The performance characteristics listed herein are not tested or guaranteed. In some graphs or tables, the data presented may be outside the specified operating range (e.g., outside specified power supply range) and therefore outside the warranted range.

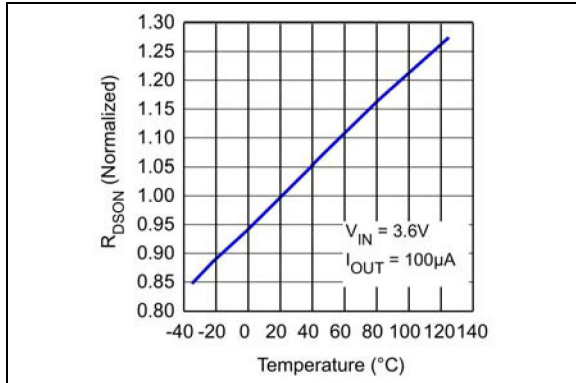

FIGURE 2-1: MIC94080/1/2/3/4/5 $R_{DS(ON)}$ Variance vs. Temperature.

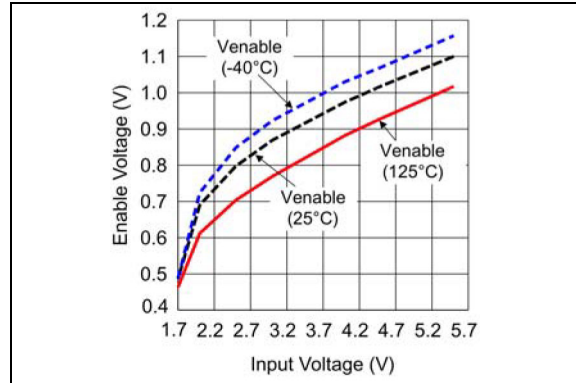

FIGURE 2-4: MIC94080/1 Enable Threshold vs. Input Voltage.

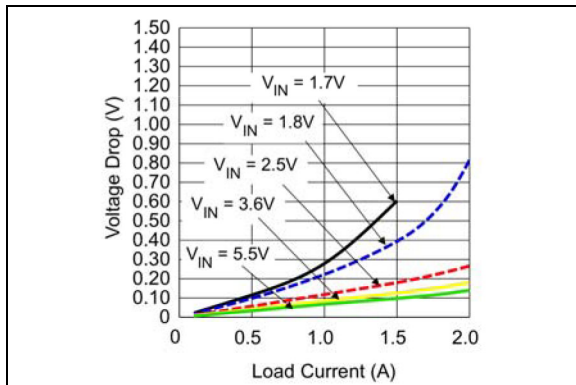

FIGURE 2-2: MIC94080/1/2/3/4/5 Voltage Drop vs. Load Current.

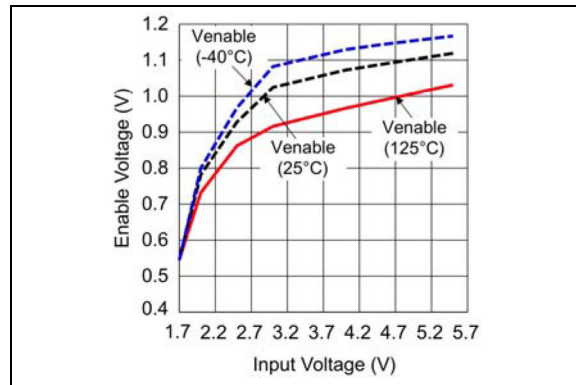

FIGURE 2-5: MIC94082/3/4/5 Enable Threshold vs. Input Voltage.

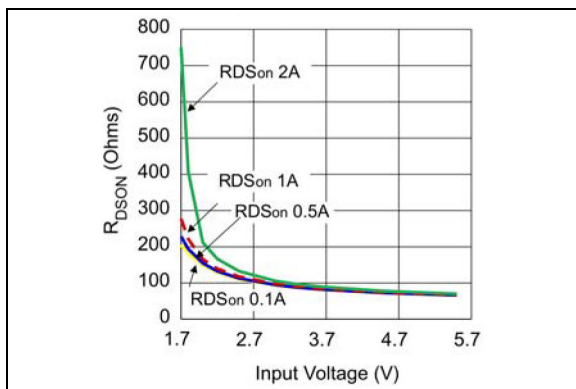

FIGURE 2-3: MIC94080/1/2/3/4/5 On Resistance vs. Input Voltage.

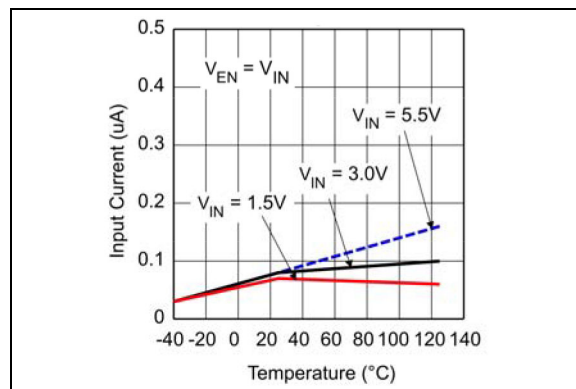

FIGURE 2-6: MIC94080/1 Input Current vs. Temperature.

MIC94080/1/2/3/4/5

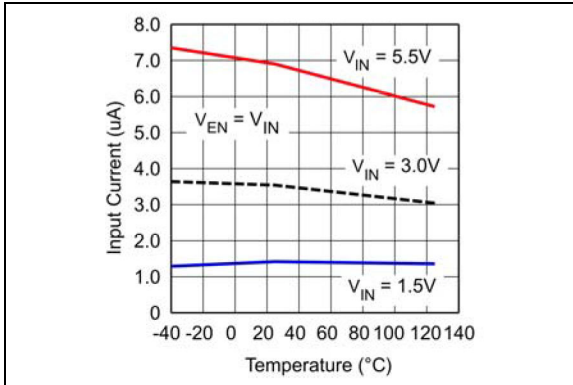

FIGURE 2-7: MIC94082/3/4/5 Input Current vs. Temperature.

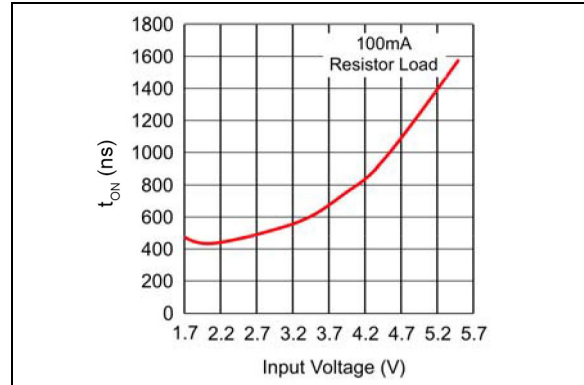

FIGURE 2-10: MIC94082/3 t_{ON} Delay vs. Input Voltage.

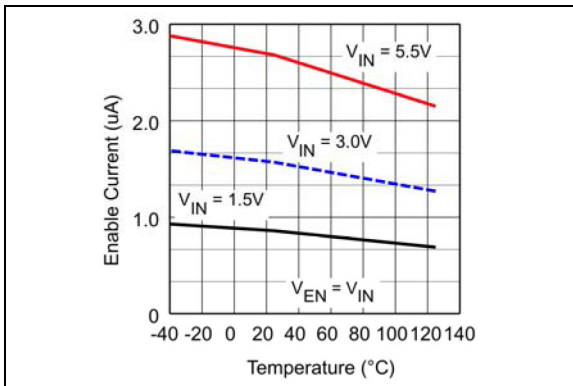

FIGURE 2-8: MIC94081/2/3/4/5 Enable Current vs. Temperature.

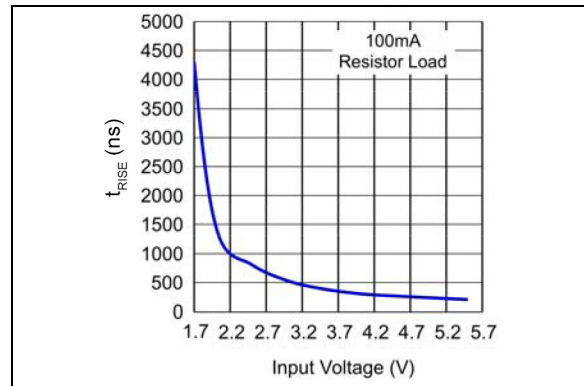

FIGURE 2-11: MIC94080/1 Rise Time vs. Input Voltage.

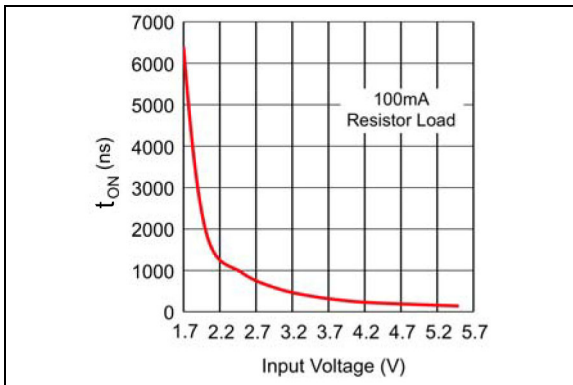

FIGURE 2-9: MIC94080/1 t_{ON} Delay vs. Input Voltage.

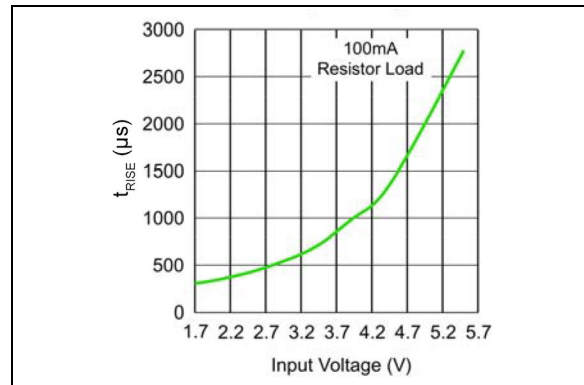

FIGURE 2-12: MIC94082/3 Rise Time vs. Input Voltage.

MIC94080/1/2/3/4/5

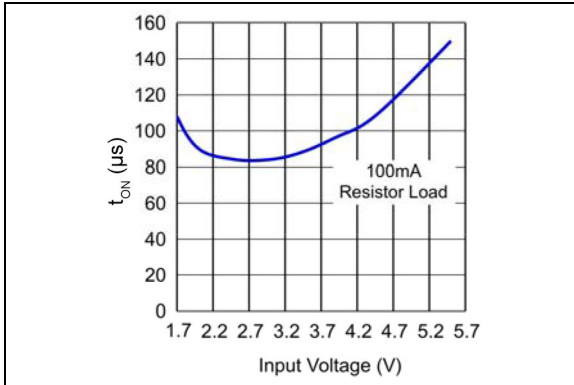

FIGURE 2-13: MIC94084/5 t_{ON} Delay vs. Input Voltage.

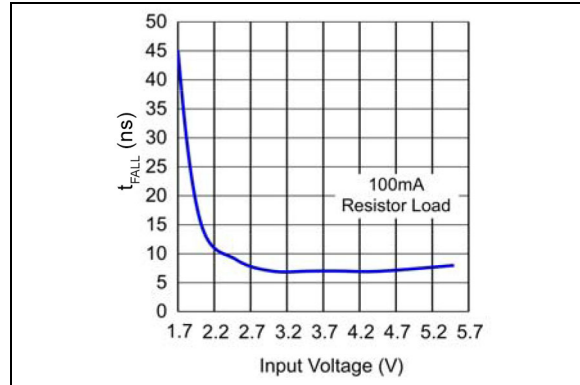

FIGURE 2-16: MIC94080/1/2/3/4/5 Fall Time vs. Input Voltage.

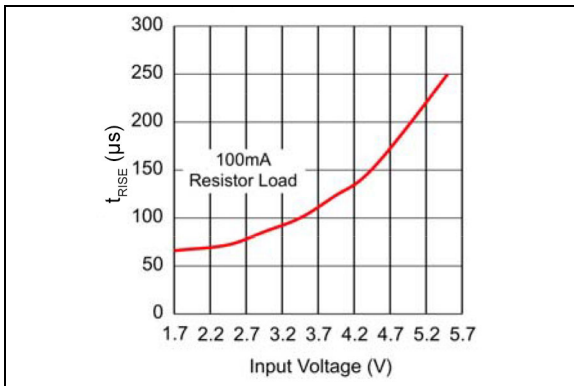

FIGURE 2-14: MIC94084/5 Rise Time vs. Input Voltage.

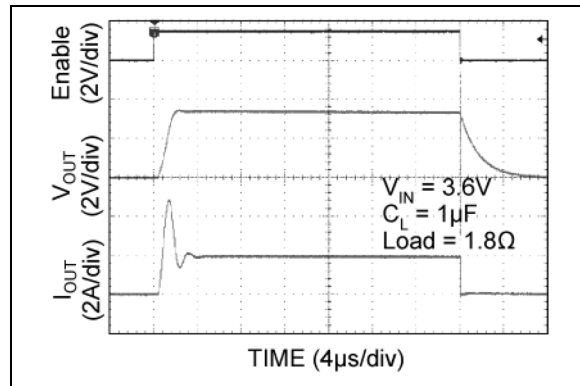

FIGURE 2-17: MIC94080 Scope 1.

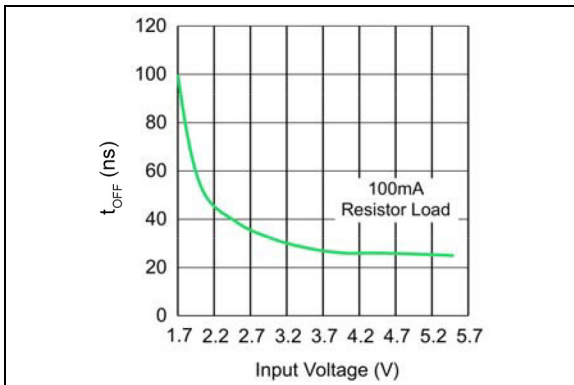

FIGURE 2-15: MIC94080/1/2/3/4/5 t_{OFF} Delay vs. Input Voltage.

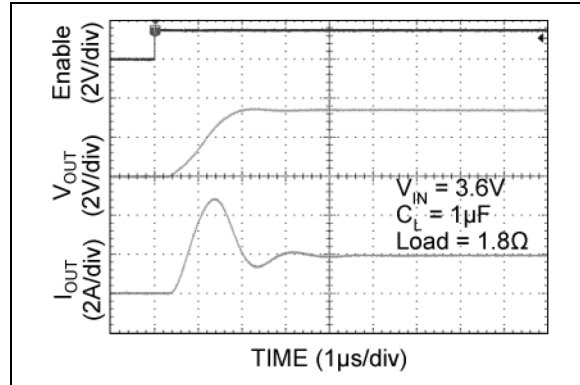

FIGURE 2-18: MIC94080 Scope 2.

MIC94080/1/2/3/4/5

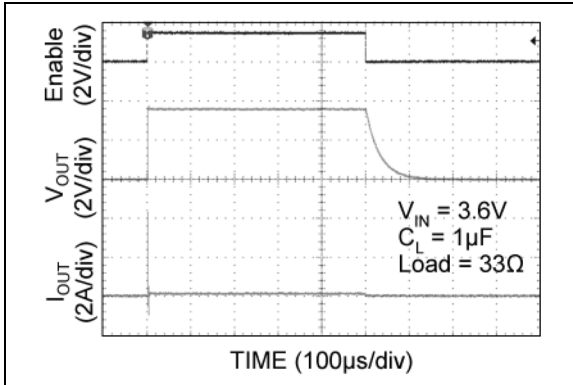

FIGURE 2-19: MIC94080 Scope 3.

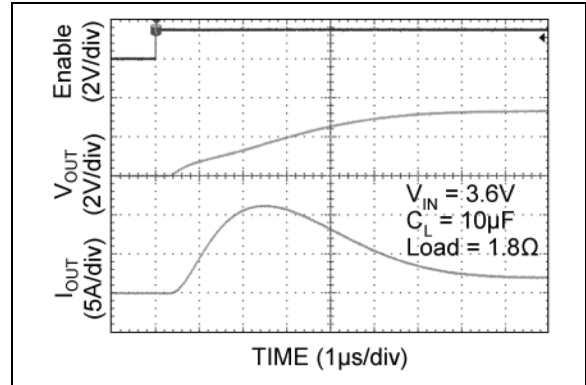

FIGURE 2-22: MIC94080 Scope 6.

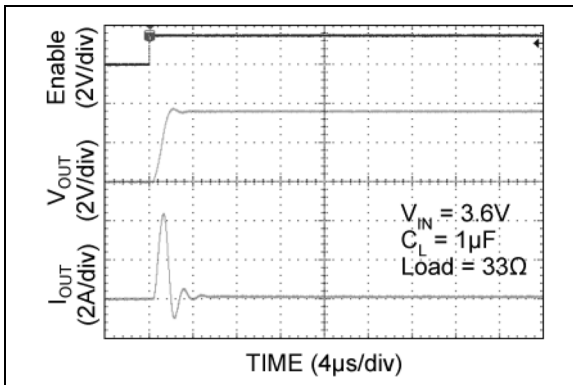

FIGURE 2-20: MIC94080 Scope 4.

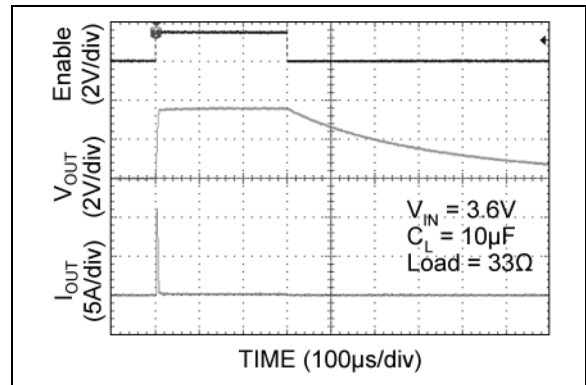

FIGURE 2-23: MIC94080 Scope 7.

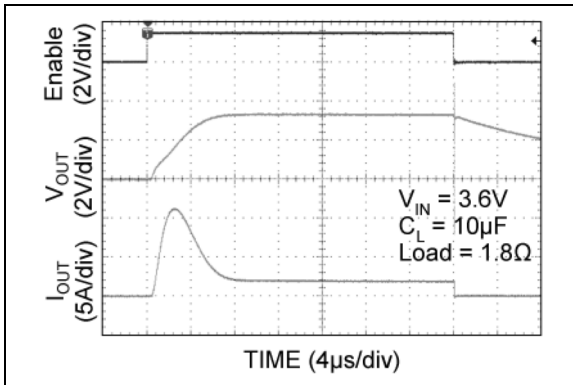

FIGURE 2-21: MIC94080 Scope 5.

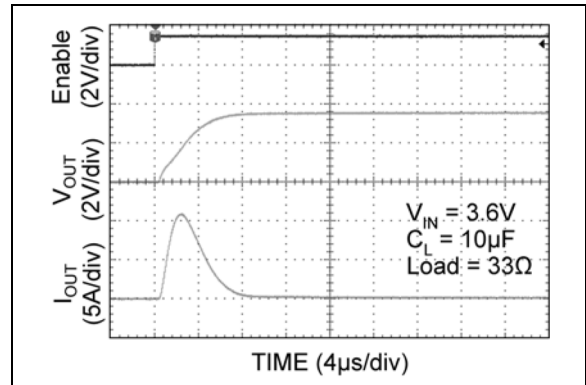

FIGURE 2-24: MIC94080 Scope 8.

MIC94080/1/2/3/4/5

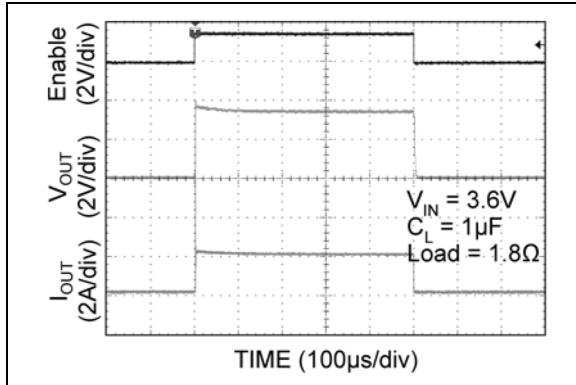

FIGURE 2-25: MIC94081 Scope 1.

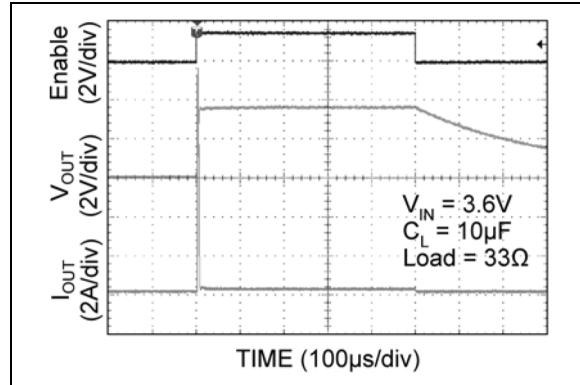

FIGURE 2-28: MIC94081 Scope 4.

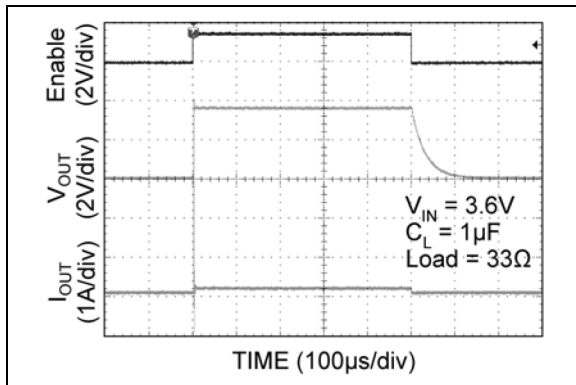

FIGURE 2-26: MIC94081 Scope 2.

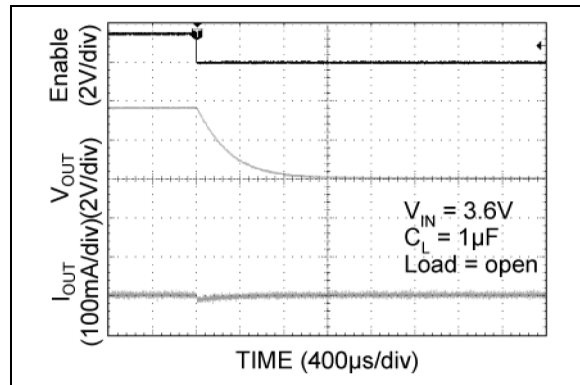

FIGURE 2-29: MIC94081 Scope 5.

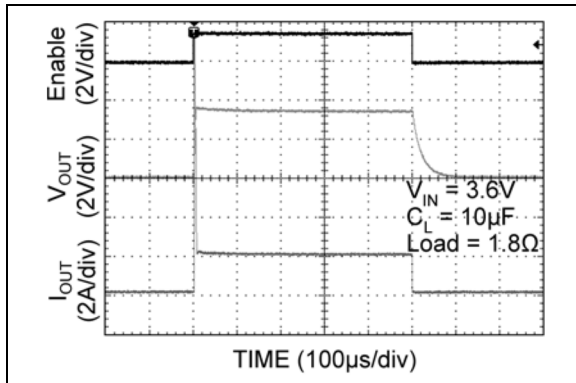

FIGURE 2-27: MIC94081 Scope 3.

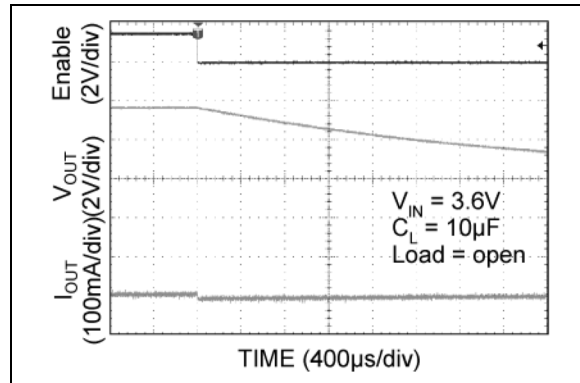
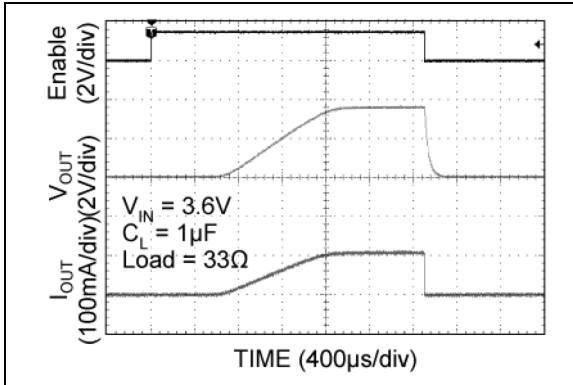
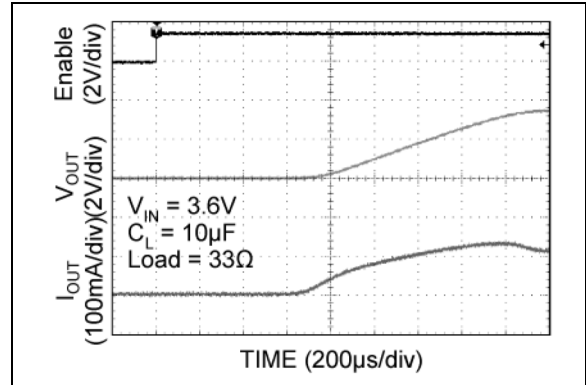
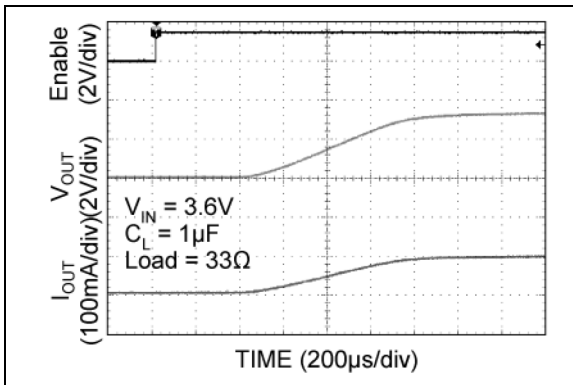
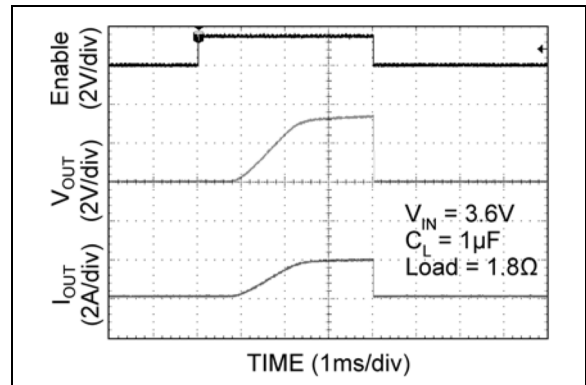
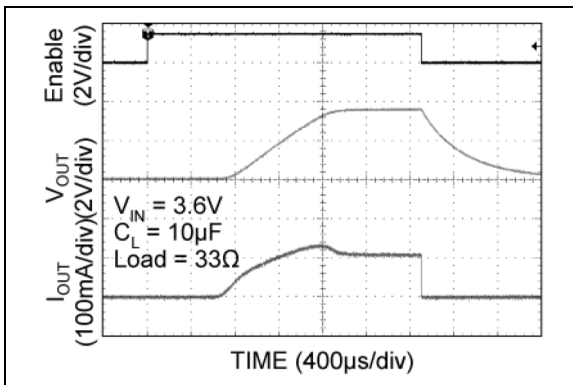
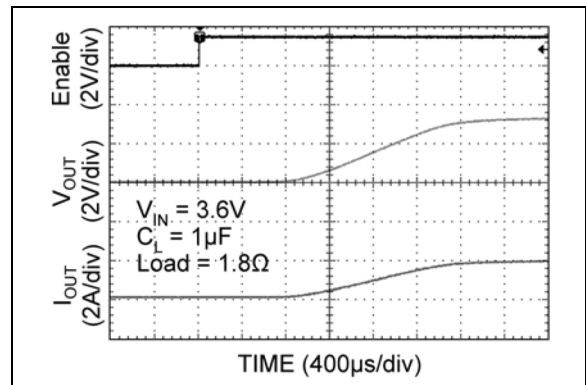

FIGURE 2-30: MIC94081 Scope 6.

MIC94080/1/2/3/4/5**FIGURE 2-31:** MIC94082 Scope 1.**FIGURE 2-34:** MIC94082 Scope 4.**FIGURE 2-32:** MIC94082 Scope 2.**FIGURE 2-35:** MIC94082 Scope 5.**FIGURE 2-33:** MIC94082 Scope 3.**FIGURE 2-36:** MIC94082 Scope 6.

MIC94080/1/2/3/4/5

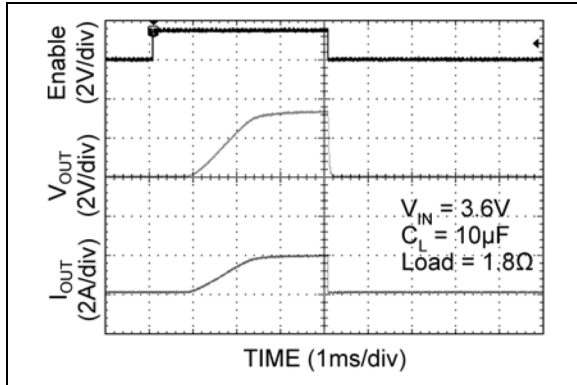

FIGURE 2-37: MIC94082 Scope 7.

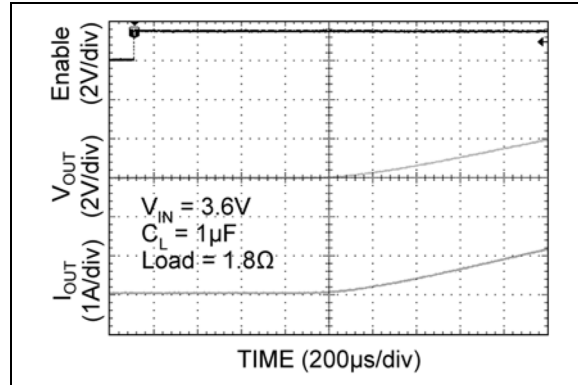

FIGURE 2-40: MIC94083 Scope 2.

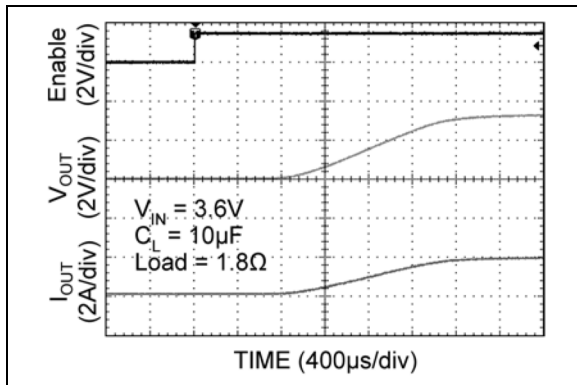

FIGURE 2-38: MIC94082 Scope 8.

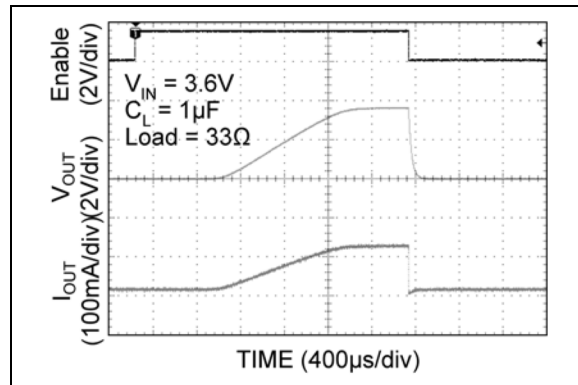

FIGURE 2-41: MIC94083 Scope 3.

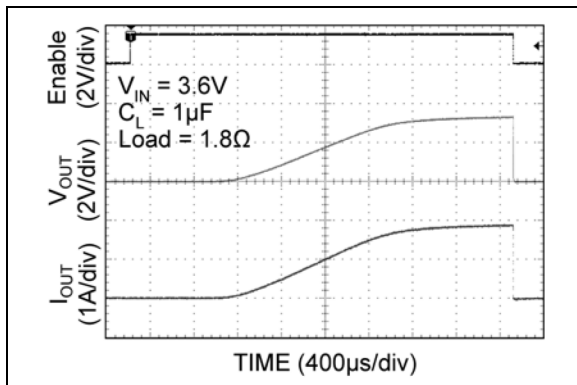

FIGURE 2-39: MIC94083 Scope 1.

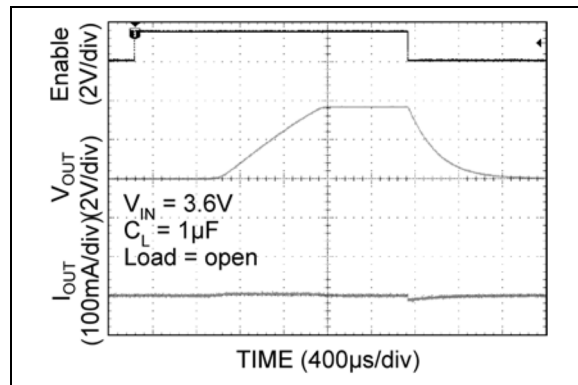

FIGURE 2-42: MIC94083 Scope 4.

MIC94080/1/2/3/4/5

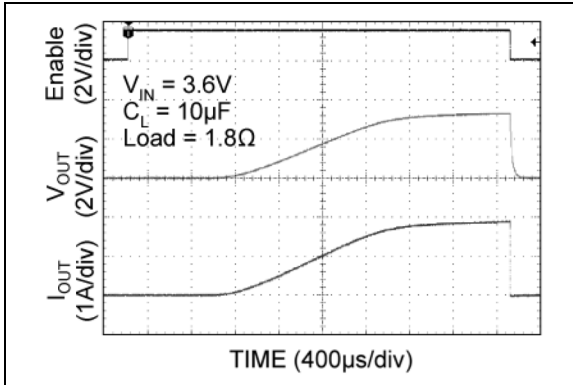

FIGURE 2-43: MIC94083 Scope 5.

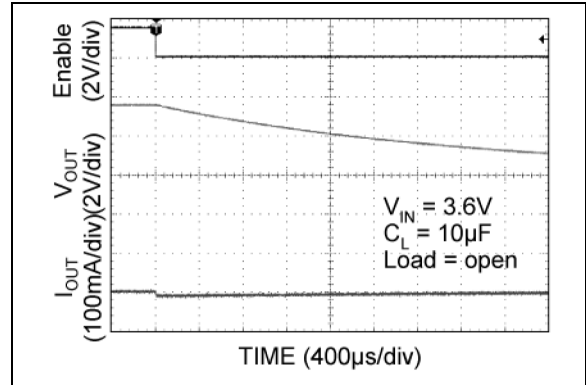

FIGURE 2-46: MIC94083 Scope 8.

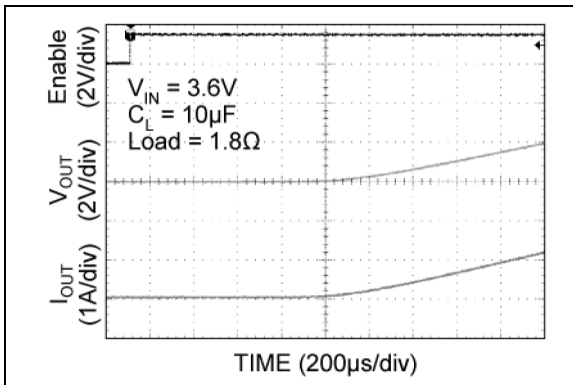

FIGURE 2-44: MIC94083 Scope 6.

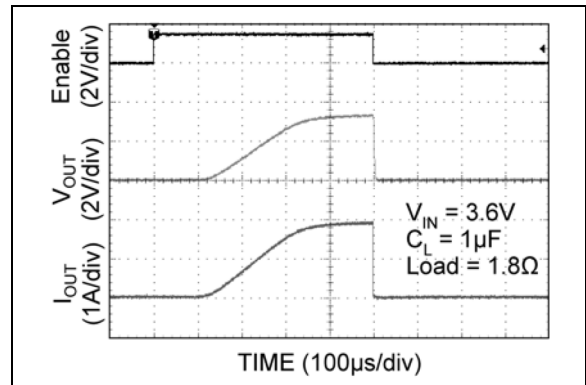

FIGURE 2-47: MIC94084 Scope 1.

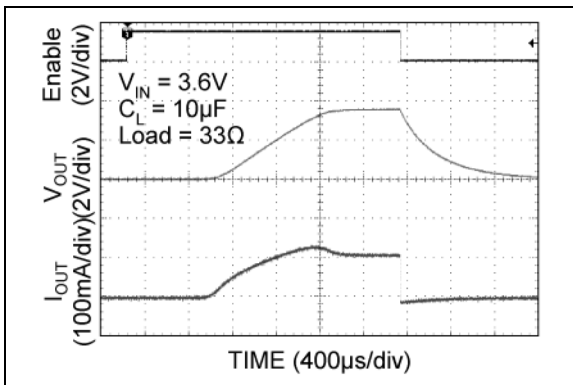

FIGURE 2-45: MIC94083 Scope 7.

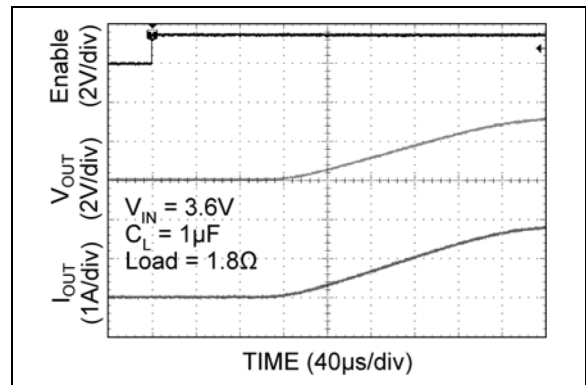

FIGURE 2-48: MIC94084 Scope 2.

MIC94080/1/2/3/4/5

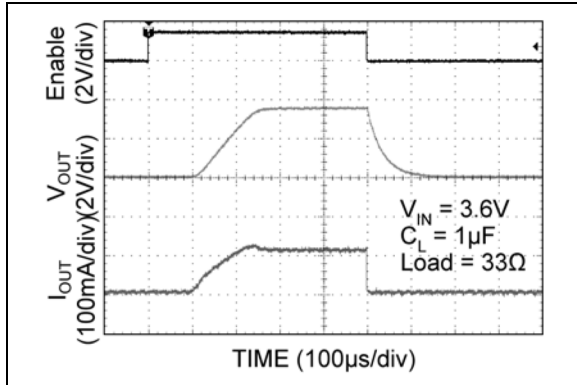

FIGURE 2-49: MIC94084 Scope 3.

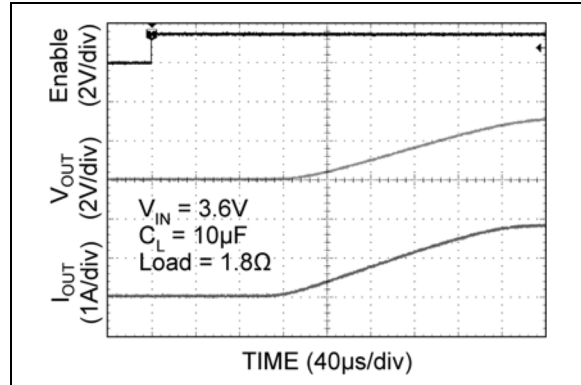

FIGURE 2-52: MIC94084 Scope 6.

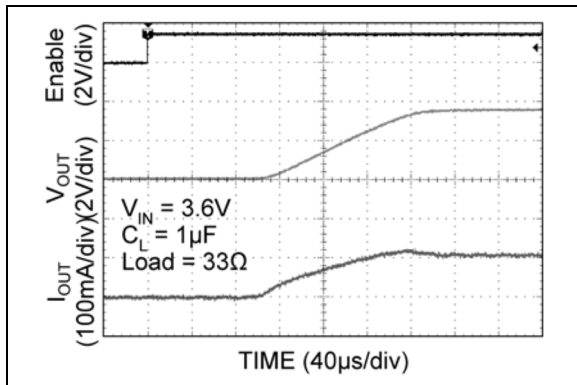

FIGURE 2-50: MIC94084 Scope 4.

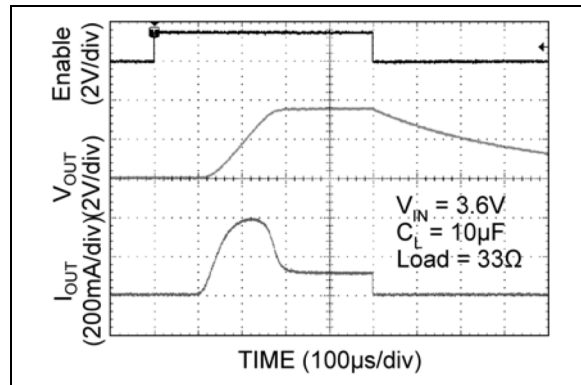

FIGURE 2-53: MIC94084 Scope 7.

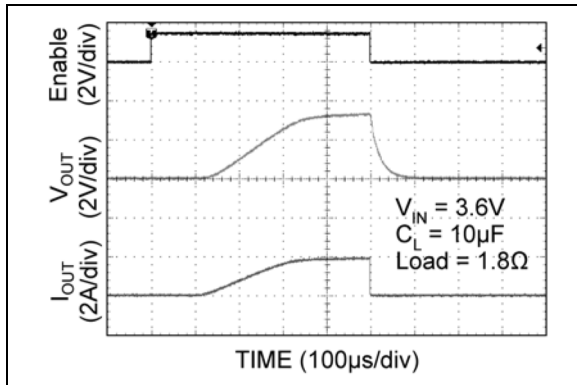

FIGURE 2-51: MIC94084 Scope 5.

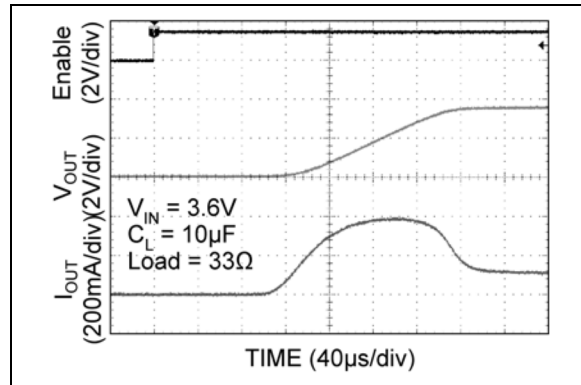

FIGURE 2-54: MIC94084 Scope 8.

MIC94080/1/2/3/4/5

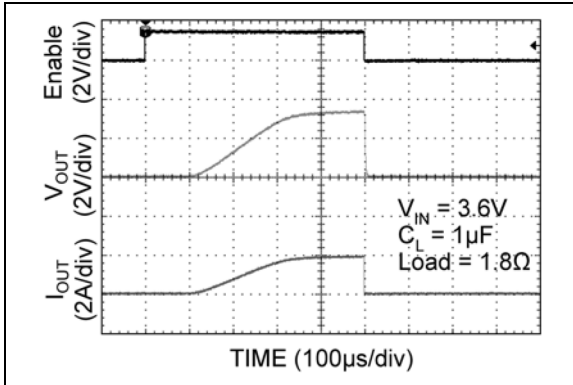

FIGURE 2-55: MIC94085 Scope 1.

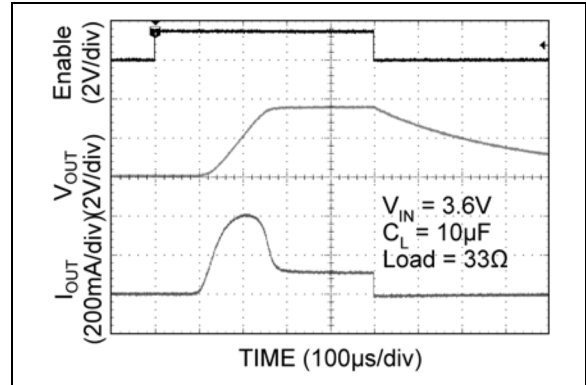

FIGURE 2-58: MIC94085 Scope 4.

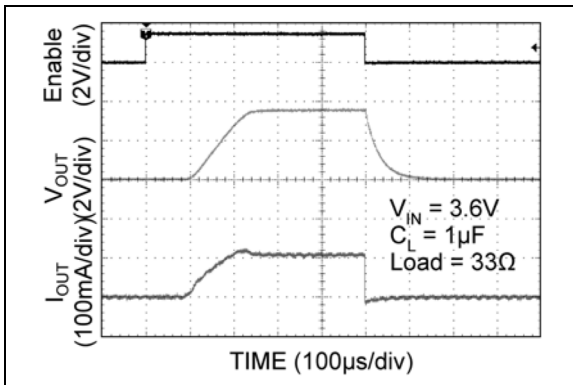

FIGURE 2-56: MIC94085 Scope 2.

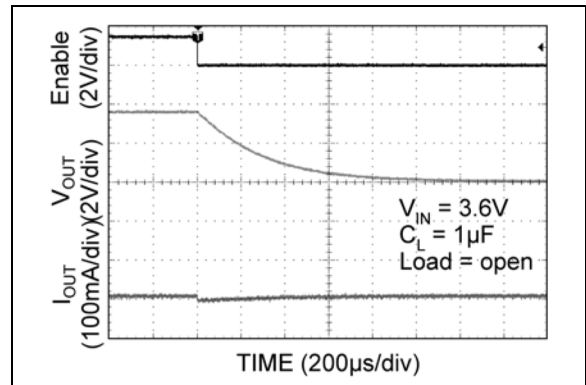

FIGURE 2-59: MIC94085 Scope 5.

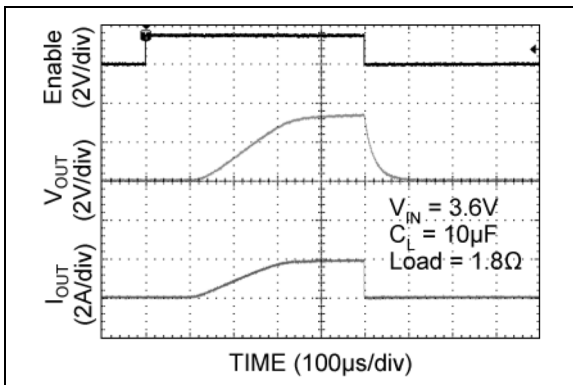

FIGURE 2-57: MIC94085 Scope 3.

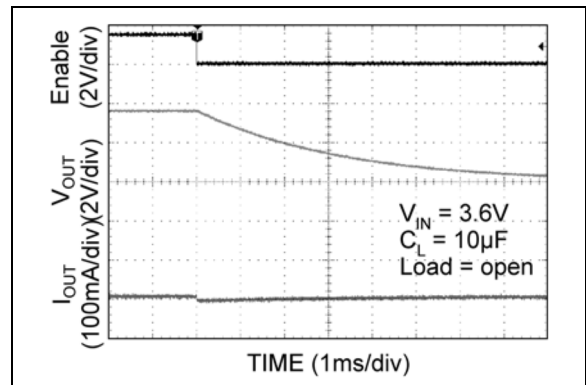

FIGURE 2-60: MIC94085 Scope 6.

MIC94080/1/2/3/4/5

3.0 PIN DESCRIPTIONS

The descriptions of the pins are listed in [Table 3-1](#).

TABLE 3-1: PIN FUNCTION TABLE

Pin Number	Pin Name	Description
1	V _{OUT}	Drain of P-Channel MOSFET.
2	GND	Ground. Should be connected to electrical ground.
3	V _{IN}	Source of P-Channel MOSFET.
4	EN	Enable (Input): Active-high CMOS/TTL control input for switch. Internal ~2 M Ω pull-down resistor. Output will be off if this pin is left floating.

4.0 APPLICATION INFORMATION

4.1 Power Switch SOA

The safe operating area (SOA) curve represents the boundary of maximum safe operating current and maximum safe operating junction temperature.

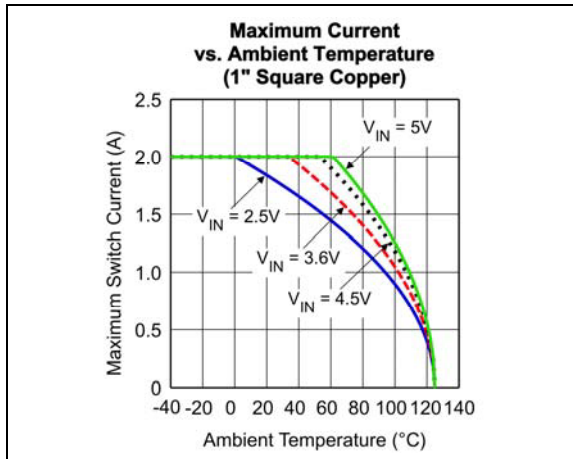

FIGURE 4-1: SOA Graph.

The curves above show the SOA for various V_{IN} values mounted on a typical one-layer, 1 square inch copper board.

4.2 Power Dissipation Considerations

As with all power switches, the current rating of the switch is limited mostly by the thermal properties of the package and the PCB on which it's mounted. There is a simple Ohm's law type relationship between thermal resistance, power dissipation, and temperature that are analogous to an electrical circuit.

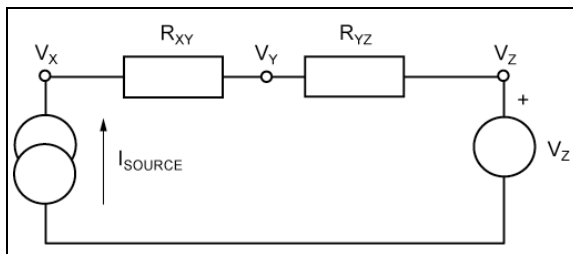

FIGURE 4-2: Simple Electrical Circuit.

From this simple circuit, one can calculate V_X if one knows I_{SOURCE} , V_Z , and the resistor values for R_{XY} and R_{YZ} using [Equation 4-1](#).

EQUATION 4-1:

$$V_X = I_{SOURCE} \times (R_{XY} + R_{YZ}) + V_Z$$

Thermal circuits can be considered using these same rules and can be drawn similarly by replacing current sources with power dissipation (in Watts), resistance with thermal resistance (in °C/W), and voltage sources with temperature (in °C).

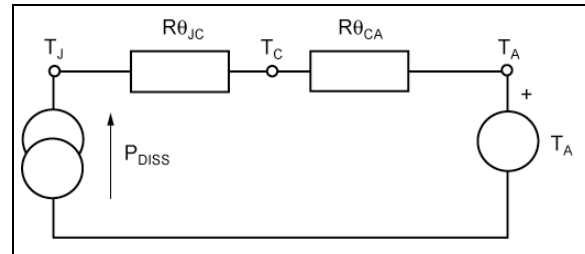

FIGURE 4-3: Simple Thermal Circuit.

By replacing the variables in the equation for V_X , one can find the junction temperature (T_J) from power dissipation, ambient temperature, and then know thermal resistance of the PCB ($R_{\theta_{CA}}$) and the package ($R_{\theta_{JC}}$).

EQUATION 4-2:

$$T_J = P_{DISS} \times (R_{\theta_{JC}} + R_{\theta_{CA}}) + T_A$$

P_{DISS} is calculated as $I_{SWITCH}^2 \times R_{SW(MAX)}$. $R_{\theta_{JC}}$ is found in the [Temperature Specifications](#) section of this data sheet and $R_{\theta_{CA}}$ (the PCB thermal resistance) values for various PCB copper areas is discussed in [Designing with Low Dropout Voltage Regulators](#).

4.2.1 AN EXAMPLE

A switch is intended to drive a 1A load and is placed on a PCB that has a ground plane area of at least 25 mm by 25 mm (625 mm²). The voltage source is a Li-ion battery with a lower operating threshold of 3V and the ambient temperature of the assembly can be up to 50°C.

Summary of variables:

- $I_{SW} = 1A$
- $V_{IN} = 3V$ to 4.2V
- $T_A = 50^\circ C$
- $R_{\theta_{JC}} = 85^\circ C/W$
- $R_{\theta_{CA}} = 53^\circ C/W$ (as read from [Figure 4-4](#))

MIC94080/1/2/3/4/5

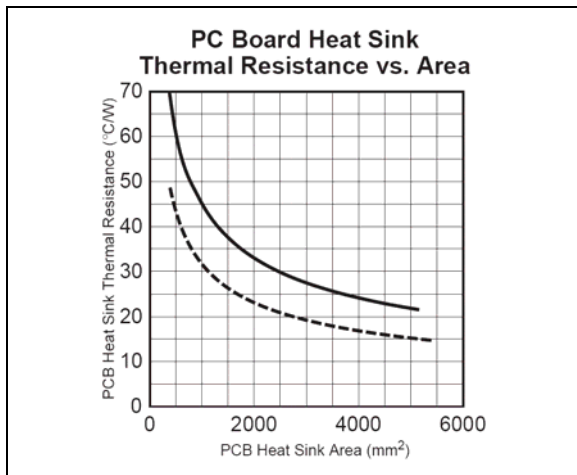

FIGURE 4-4: Excerpt from the LDO Book.

EQUATION 4-3:

$$P_{DISS} = I_{SW}^2 \times R_{SW(MAX)}$$

The worst case switch resistance ($R_{SW(MAX)}$) at the lowest V_{IN} of 3V is not available in the data sheet, so the next lowest value of V_{IN} is used.

$R_{SW(MAX)}$ at 2.5V is 200 m Ω .

An additional consideration is to allow for the maximum junction temperature of 125°C. If this was a calculation for the worst case $R_{SW(MAX)}$ for 25°C, the actual worst case resistance in this case can be 30% higher (see [Figure 2-1](#)). However, 200 m Ω is the maximum over temperature. Therefore:

EQUATION 4-4:

$$T_J = 1^2 \times 0.2 \times (85 + 53) + 50 = 78^\circ C$$

This is below the maximum of 125°C.

MIC94080/1/2/3/4/5

5.0 PACKAGING INFORMATION

5.1 Package Marking Information

4-Lead FTDFN*

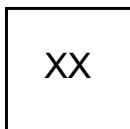

Example

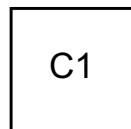
**TABLE 5-1: MARKING CODES**

Part Number	Marking Code	Features
MIC94080YFT-TR	C1	Fast Turn-On
MIC94081YFT-TR	C2	Fast Turn-On, Load Discharge
MIC94082YFT-TR	C5	800 μ s Soft-Start
MIC94083YFT-TR	C7	800 μ s Soft-Start, Load Discharge
MIC94084YFT-TR	C0	120 μ s Soft-Start
MIC94085YFT-TR	1C	120 μ s Soft-Start, Load Discharge

Legend:	XX...X	Product code or customer-specific information
	Y	Year code (last digit of calendar year)
	YY	Year code (last 2 digits of calendar year)
	WW	Week code (week of January 1 is week '01')
	NNN	Alphanumeric traceability code
	(e3)	Pb-free JEDEC [®] designator for Matte Tin (Sn)
	*	This package is Pb-free. The Pb-free JEDEC designator ((e3)) can be found on the outer packaging for this package.
	•, ▲, ▼	Pin one index is identified by a dot, delta up, or delta down (triangle mark).
Note:	In the event the full Microchip part number cannot be marked on one line, it will be carried over to the next line, thus limiting the number of available characters for customer-specific information. Package may or may not include the corporate logo.	
	Underbar (¯) and/or Overbar (¯) symbol may not be to scale.	

MIC94080/1/2/3/4/5

4-Lead FTDFN Package Outline & Recommended Land Pattern

TITLE

4 LEAD FTDFN 0.85x0.85 mm PACKAGE (Flip Chip) OUTLINE & RECOMMENDED LAND PATTERN

DRAWING #	FTDFN085085-4LD-PL-1	UNIT	MM
LEAD FRAME	Copper Alloy	LEAD FINISH	NiPdAu

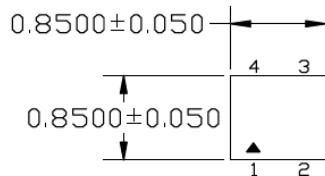

TOP VIEW
NOTE: 1, 2, 3

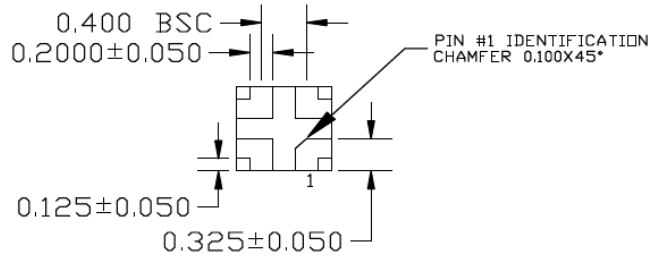

BOTTOM VIEW
NOTE: 1, 2, 3

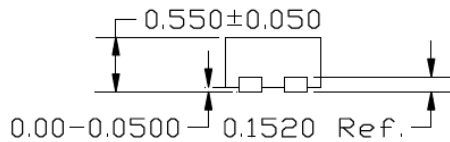

END VIEW
NOTE: 1, 2, 3

NOTE:

1. MAX PACKAGE WARPAGE IS 0.05 MM
2. MAX ALLOWABLE BURR IS 0.076 MM IN ALL DIRECTIONS
3. PIN #1 IS ON TOP WILL BE LASER MARKED
4. GREEN COLORED RECTANGLES (SHADED AREA) REPRESENT SOLDER STENCIL OPENING ON EXPOSED METAL TRACE.
5. CYAN COLORED RECTANGLES (SHADED AREA) REPRESENT OPTIONAL SOLDER STENCIL OPENING.

Note: For the most current package drawings, please see the Microchip Packaging Specification located at <http://www.microchip.com/packaging>.

MIC94080/1/2/3/4/5

POD-Land Pattern drawing #FTDFN085085-4LD-PL-1

RECOMMENDED LAND PATTERN

NOTE: 4, 5

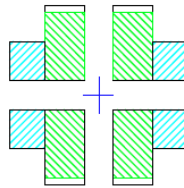
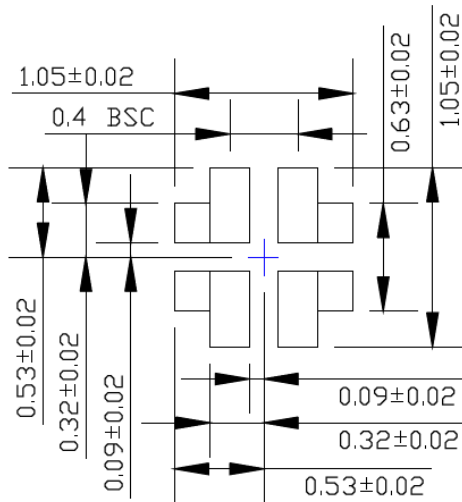
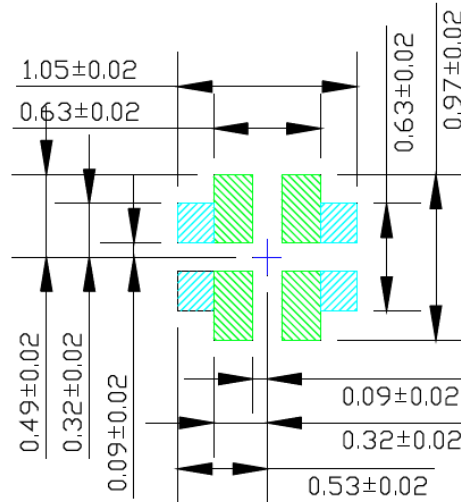
STACKED-UPEXPOSED METAL TRACESOLDER STENCIL OPENING

Note: For the most current package drawings, please see the Microchip Packaging Specification located at <http://www.microchip.com/packaging>.

MIC94080/1/2/3/4/5

NOTES:

MIC94080/1/2/3/4/5

APPENDIX A: REVISION HISTORY

Revision A (March 2019)

- Converted Micrel document MIC94080/1/2/3/4/5 to Microchip data sheet template DS20006118A.
- Minor grammatical text changes throughout.

MIC94080/1/2/3/4/5

NOTES:

MIC94080/1/2/3/4/5

PRODUCT IDENTIFICATION SYSTEM

To order or obtain information, e.g., on pricing or delivery, contact your local Microchip representative or sales office.

Device	<u>X</u>	<u>XX</u>	<u>-XX</u>	Examples:
Part No.	Junction Temp. Range	Package	Media Type	
Device:				
MIC94080:		67 mΩ $R_{DS(ON)}$ 2A High-Side Load Switch with Fast Turn-On		a) MIC94080YFT-TR: MIC94080, -40°C to +125°C Temperature Range, 4-Lead FTDFN, 5,000/Reel
MIC94081:		67 mΩ $R_{DS(ON)}$ 2A High-Side Load Switch with Fast Turn-On and Load Discharge		b) MIC94081YFT-TR: MIC94081, -40°C to +125°C Temperature Range, 4-Lead FTDFN, 5,000/Reel
MIC94082:		67 mΩ $R_{DS(ON)}$ 2A High-Side Load Switch with 800 μs Soft-Start		c) MIC94082YFT-TR: MIC94082, -40°C to +125°C Temperature Range, 4-Lead FTDFN, 5,000/Reel
MIC94083:		67 mΩ $R_{DS(ON)}$ 2A High-Side Load Switch with 800 μs Soft-Start and Load Discharge		d) MIC94083YFT-TR: MIC94083, -40°C to +125°C Temperature Range, 4-Lead FTDFN, 5,000/Reel
MIC94084:		67 mΩ $R_{DS(ON)}$ 2A High-Side Load Switch with 120 μs Soft-Start		e) MIC94084YFT-TR: MIC94084, -40°C to +125°C Temperature Range, 4-Lead FTDFN, 5,000/Reel
MIC94085:		67 mΩ $R_{DS(ON)}$ 2A High-Side Load Switch with 120 μs Soft-Start and Load Discharge		f) MIC94085YFT-TR: MIC94085, -40°C to +125°C Temperature Range, 4-Lead FTDFN, 5,000/Reel
Junction Temperature Range:	Y =	-40°C to +125°C, RoHS-Compliant		Note 1: Tape and Reel identifier only appears in the catalog part number description. This identifier is used for ordering purposes and is not printed on the device package. Check with your Microchip Sales Office for package availability with the Tape and Reel option.
Package:	FT =	4-Lead 0.85 mm x 0.85 mm FTDFN		
Media Type:	TR =	5,000/Reel		

MIC94080/1/2/3/4/5

NOTES:

Note the following details of the code protection feature on Microchip devices:

- Microchip products meet the specification contained in their particular Microchip Data Sheet.
- Microchip believes that its family of products is one of the most secure families of its kind on the market today, when used in the intended manner and under normal conditions.
- There are dishonest and possibly illegal methods used to breach the code protection feature. All of these methods, to our knowledge, require using the Microchip products in a manner outside the operating specifications contained in Microchip's Data Sheets. Most likely, the person doing so is engaged in theft of intellectual property.
- Microchip is willing to work with the customer who is concerned about the integrity of their code.
- Neither Microchip nor any other semiconductor manufacturer can guarantee the security of their code. Code protection does not mean that we are guaranteeing the product as “unbreakable.”

Code protection is constantly evolving. We at Microchip are committed to continuously improving the code protection features of our products. Attempts to break Microchip's code protection feature may be a violation of the Digital Millennium Copyright Act. If such acts allow unauthorized access to your software or other copyrighted work, you may have a right to sue for relief under that Act.

Information contained in this publication regarding device applications and the like is provided only for your convenience and may be superseded by updates. It is your responsibility to ensure that your application meets with your specifications. MICROCHIP MAKES NO REPRESENTATIONS OR WARRANTIES OF ANY KIND WHETHER EXPRESS OR IMPLIED, WRITTEN OR ORAL, STATUTORY OR OTHERWISE, RELATED TO THE INFORMATION, INCLUDING BUT NOT LIMITED TO ITS CONDITION, QUALITY, PERFORMANCE, MERCHANTABILITY OR FITNESS FOR PURPOSE. Microchip disclaims all liability arising from this information and its use. Use of Microchip devices in life support and/or safety applications is entirely at the buyer's risk, and the buyer agrees to defend, indemnify and hold harmless Microchip from any and all damages, claims, suits, or expenses resulting from such use. No licenses are conveyed, implicitly or otherwise, under any Microchip intellectual property rights unless otherwise stated.

Microchip received ISO/TS-16949:2009 certification for its worldwide headquarters, design and wafer fabrication facilities in Chandler and Tempe, Arizona; Gresham, Oregon and design centers in California and India. The Company's quality system processes and procedures are for its PIC® MCUs and dsPIC® DSCs, KEELOQ® code hopping devices, Serial EEPROMs, microperipherals, nonvolatile memory and analog products. In addition, Microchip's quality system for the design and manufacture of development systems is ISO 9001:2000 certified.

**QUALITY MANAGEMENT SYSTEM
CERTIFIED BY DNV
= ISO/TS 16949 =**

Trademarks

The Microchip name and logo, the Microchip logo, AnyRate, AVR, AVR logo, AVR Freaks, BitCloud, chipKIT, chipKIT logo, CryptoMemory, CryptoRF, dsPIC, FlashFlex, flexPWR, Helder, JukeBlox, KeeLoq, Klear, LANCheck, LINK MD, maXStylus, maXTouch, MediaLB, megaAVR, MOST, MOST logo, MPLAB, OptoLyzer, PIC, picoPower, PICSTART, PIC32 logo, Prochip Designer, QTouch, SAM-BA, SpyNIC, SST, SST Logo, SuperFlash, tinyAVR, UNI/O, and XMEGA are registered trademarks of Microchip Technology Incorporated in the U.S.A. and other countries.

ClockWorks, The Embedded Control Solutions Company, EtherSynch, Hyper Speed Control, HyperLight Load, IntellIMOS, mTouch, Precision Edge, and Quiet-Wire are registered trademarks of Microchip Technology Incorporated in the U.S.A.

Adjacent Key Suppression, AKS, Analog-for-the-Digital Age, Any Capacitor, AnyIn, AnyOut, BodyCom, CodeGuard, CryptoAuthentication, CryptoAutomotive, CryptoCompanion, CryptoController, dsPICDEM, dsPICDEM.net, Dynamic Average Matching, DAM, ECAN, EtherGREEN, In-Circuit Serial Programming, ICSP, INICnet, Inter-Chip Connectivity, JitterBlocker, KlearNet, KlearNet logo, memBrain, Mindi, MiWi, motorBench, MPASM, MPF, MPLAB Certified logo, MPLIB, MPLINK, MultiTRAK, NetDetach, Omniscient Code Generation, PICDEM, PICDEM.net, PICKit, PICtail, PowerSmart, PureSilicon, QMatrix, REAL ICE, Ripple Blocker, SAM-ICE, Serial Quad I/O, SMART-I.S., SQI, SuperSwitcher, SuperSwitcher II, Total Endurance, TSHARC, USBCheck, VariSense, ViewSpan, WiperLock, Wireless DNA, and ZENA are trademarks of Microchip Technology Incorporated in the U.S.A. and other countries.

SQTP is a service mark of Microchip Technology Incorporated in the U.S.A.

Silicon Storage Technology is a registered trademark of Microchip Technology Inc. in other countries.

GestIC is a registered trademark of Microchip Technology Germany II GmbH & Co. KG, a subsidiary of Microchip Technology Inc., in other countries.

All other trademarks mentioned herein are property of their respective companies.

© 2019, Microchip Technology Incorporated, All Rights Reserved.
ISBN: 978-1-5224-4271-4



MICROCHIP

Worldwide Sales and Service

AMERICAS

Corporate Office
2355 West Chandler Blvd.
Chandler, AZ 85224-6199
Tel: 480-792-7200
Fax: 480-792-7277
Technical Support:
<http://www.microchip.com/support>
Web Address:
www.microchip.com

Atlanta

Duluth, GA
Tel: 678-957-9614
Fax: 678-957-1455

Austin, TX

Tel: 512-257-3370

Boston

Westborough, MA
Tel: 774-760-0087
Fax: 774-760-0088

Chicago

Itasca, IL
Tel: 630-285-0071
Fax: 630-285-0075

Dallas

Addison, TX
Tel: 972-818-7423
Fax: 972-818-2924

Detroit

Novi, MI
Tel: 248-848-4000

Houston, TX

Tel: 281-894-5983

Indianapolis

Noblesville, IN
Tel: 317-773-8323
Fax: 317-773-5453
Tel: 317-536-2380

Los Angeles

Mission Viejo, CA
Tel: 949-462-9523
Fax: 949-462-9608
Tel: 951-273-7800

Raleigh, NC

Tel: 919-844-7510

New York, NY

Tel: 631-435-6000

San Jose, CA

Tel: 408-735-9110
Tel: 408-436-4270

Canada - Toronto

Tel: 905-695-1980
Fax: 905-695-2078

ASIA/PACIFIC

Australia - Sydney

Tel: 61-2-9868-6733

China - Beijing

Tel: 86-10-8569-7000

China - Chengdu

Tel: 86-28-8665-5511

China - Chongqing

Tel: 86-23-8980-9588

China - Dongguan

Tel: 86-769-8702-9880

China - Guangzhou

Tel: 86-20-8755-8029

China - Hangzhou

Tel: 86-571-8792-8115

China - Hong Kong SAR

Tel: 852-2943-5100

China - Nanjing

Tel: 86-25-8473-2460

China - Qingdao

Tel: 86-532-8502-7355

China - Shanghai

Tel: 86-21-3326-8000

China - Shenyang

Tel: 86-24-2334-2829

China - Shenzhen

Tel: 86-755-8864-2200

China - Suzhou

Tel: 86-186-6233-1526

China - Wuhan

Tel: 86-27-5980-5300

China - Xian

Tel: 86-29-8833-7252

China - Xiamen

Tel: 86-592-2388138

China - Zhuhai

Tel: 86-756-3210040

ASIA/PACIFIC

India - Bangalore

Tel: 91-80-3090-4444

India - New Delhi

Tel: 91-11-4160-8631

India - Pune

Tel: 91-20-4121-0141

Japan - Osaka

Tel: 81-6-6152-7160

Japan - Tokyo

Tel: 81-3-6880-3770

Korea - Daegu

Tel: 82-53-744-4301

Korea - Seoul

Tel: 82-2-554-7200

Malaysia - Kuala Lumpur

Tel: 60-3-7651-7906

Malaysia - Penang

Tel: 60-4-227-8870

Philippines - Manila

Tel: 63-2-634-9065

Singapore

Tel: 65-6334-8870

Taiwan - Hsin Chu

Tel: 886-3-577-8366

Taiwan - Kaohsiung

Tel: 886-7-213-7830

Taiwan - Taipei

Tel: 886-2-2508-8600

Thailand - Bangkok

Tel: 66-2-694-1351

Vietnam - Ho Chi Minh

Tel: 84-28-5448-2100

EUROPE

Austria - Wels

Tel: 43-7242-2244-39
Fax: 43-7242-2244-393

Denmark - Copenhagen

Tel: 45-4450-2828
Fax: 45-4485-2829

Finland - Espoo

Tel: 358-9-4520-820

France - Paris

Tel: 33-1-69-53-63-20
Fax: 33-1-69-30-90-79

Germany - Garching

Tel: 49-8931-9700

Germany - Haan

Tel: 49-2129-3766400

Germany - Heilbronn

Tel: 49-7131-67-3636

Germany - Karlsruhe

Tel: 49-721-625370

Germany - Munich

Tel: 49-89-627-144-0
Fax: 49-89-627-144-44

Germany - Rosenheim

Tel: 49-8031-354-560

Israel - Ra'anana

Tel: 972-9-744-7705

Italy - Milan

Tel: 39-0331-742611
Fax: 39-0331-466781

Italy - Padova

Tel: 39-049-7625286

Netherlands - Drunen

Tel: 31-416-690399
Fax: 31-416-690340

Norway - Trondheim

Tel: 47-7288-4388

Poland - Warsaw

Tel: 48-22-3325737

Romania - Bucharest

Tel: 40-21-407-87-50

Spain - Madrid

Tel: 34-91-708-08-90
Fax: 34-91-708-08-91

Sweden - Gothenberg

Tel: 46-31-704-60-40

Sweden - Stockholm

Tel: 46-8-5090-4654

UK - Wokingham

Tel: 44-118-921-5800
Fax: 44-118-921-5820

OUR CERTIFICATE

DiGi provide top-quality products and perfect service for customer worldwide through standardization, technological innovation and continuous improvement. DiGi through third-party certification, we stricly control the quality of products and services. Welcome your RFQ to

Email: Info@DiGi-Electronics.com



Tel: +00 852-30501935

RFQ Email: Info@DiGi-Electronics.com

DiGi is a global authorized distributor of electronic components.