

RS721PXF Datasheet

www.digi-electronics.com

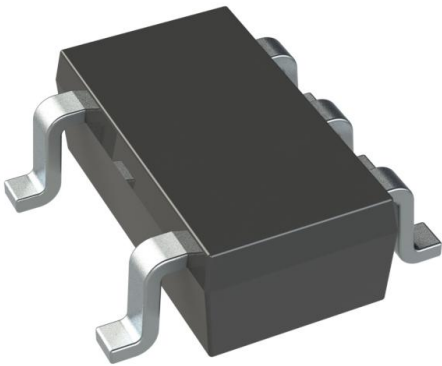

DiGi Electronics Part Number	RS721PXF-DG
Manufacturer	Runic Technology
Manufacturer Product Number	RS721PXF
Description	IC CMOS 1 CIRCUIT SOT23-5
Detailed Description	CMOS Amplifier 1 Circuit Rail-to-Rail SOT-23-5

<https://www.DiGi-Electronics.com>



Tel: +00 852-30501935

RFQ Email: Info@DiGi-Electronics.com

DiGi is a global authorized distributor of electronic components.

Purchase and inquiry

Manufacturer Product Number:

RS721PXF

Series:

-

Amplifier Type:

CMOS

Output Type:

Rail-to-Rail

Gain Bandwidth Product:

10 MHz

Voltage - Input Offset:

300 μ V

Current - Output / Channel:

140 mA

Voltage - Supply Span (Max):

5.5 V

Mounting Type:

Surface Mount

Supplier Device Package:

SOT-23-5

Manufacturer:

Runic Technology

Product Status:

Active

Number of Circuits:

1

Slew Rate:

6V/ μ s

Current - Input Bias:

1 pA

Current - Supply:

1.1mA

Voltage - Supply Span (Min):

2.5 V

Operating Temperature:

-40°C ~ 125°C

Package / Case:

SC-74A, SOT-753

Environmental & Export classification

RoHS Status:

ROHS3 Compliant

REACH Status:

REACH Unaffected

HTSUS:

8542.33.0001

Moisture Sensitivity Level (MSL):

3 (168 Hours)

ECCN:

EAR99

10MHz, Precision, Rail-to-Rail I/O CMOS Operational Amplifier

FEATURES

- **HIGH GAIN BANDWIDTH:10MHz**
- **RAIL-TO-RAIL INPUT AND OUTPUT**
0.8mV Max Vos
- **INPUT VOLTAGE RANGE: -0.2V to +5.7V**
with Vs = 5.5V
- **SUPPLY RANGE: +2.5V to +5.5V**
- **SPECIFIED UP TO +125°C**
- **Micro SIZE PACKAGES: SOT23-5**
SOT353(SC70-5)

APPLICATIONS

- **SENSORS**
- **ACTIVE FILTERS**
- **TEST EQUIPMENT**
- **DRIVING A/D CONVERTERS**
- **PHOTODIODE AMPLIFICATION**

DESCRIPTION

The RS721P, RS722P, RS724P families of products offer low voltage operation and rail-to-rail input and output, as well as excellent speed/power consumption ratio, providing an excellent bandwidth (10MHz) and slew rate of 6V/us. The op-amps are unity gain stable and feature an ultra-low input bias current.

The RS721P, RS722P and RS724P has lower offset, which is guaranteed not upper than 0.5mV at 25°C with Vs = 5V, V_{CM} = Vs/2.

The devices are ideal for sensor interfaces, active filters and portable applications. The RS721P, RS722P, RS724P families of operational amplifiers are specified at the full temperature range of -40°C to +125°C under single or dual power supplies of 2.5V to 5.5V.

Device Information ⁽¹⁾

PART NUMBER	PACKAGE	BODY SIZE(NOM)
RS721P	SOT23-5	2.90mm×1.60mm
	SOIC-8(SOP8)	4.90mm×3.90mm
	MSOP-8	3.00mm×3.00mm
	SOT353(SC70-5)	2.10mm×1.25mm
RS722P	SOIC-8(SOP8)	4.90mm×3.90mm
	MSOP-8	3.00mm×3.00mm
	TSSOP-8	3.00mm×4.40mm
	TDFN2×2-8	2.00mm×2.00mm
RS724P	SOIC-14(SOP14)	8.65mm×3.90mm
	TSSOP-14	5.00mm×4.40mm

(1) For all available packages, see the orderable addendum at the end of the data sheet.

Pin Configuration and Functions (Top View)

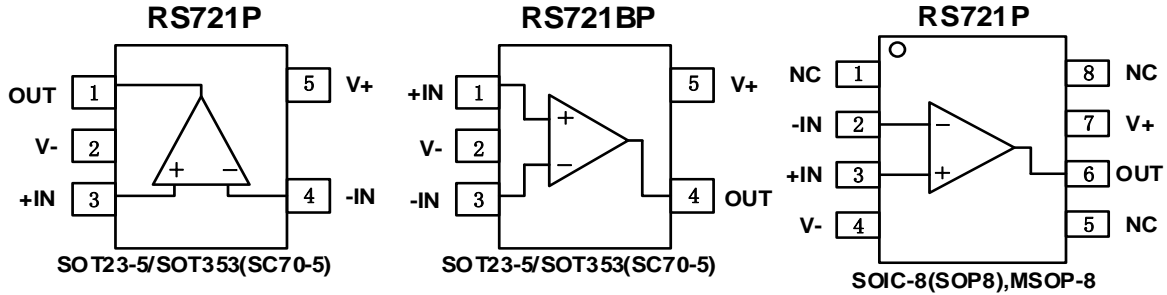

Pin Description

NAME	PIN			I/O	DESCRIPTION
	RS721P	RS721BP	RS721P		
	SOT23-5/ SOT353(SC 70-5)	SOT23-5/ SOT353(SC 70-5)	SOIC- 8(SOP8)/ MSOP8		
-IN	4	3	2	I	Negative (inverting) input
+IN	3	1	3	I	Positive (noninverting) input
NC	-	-	1,5,8	-	No internal connection (can be left floating)
OUT	1	4	6	O	Output
V-	2	2	4	-	Negative (lowest) power supply
V+	5	5	7	-	Positive (highest) power supply

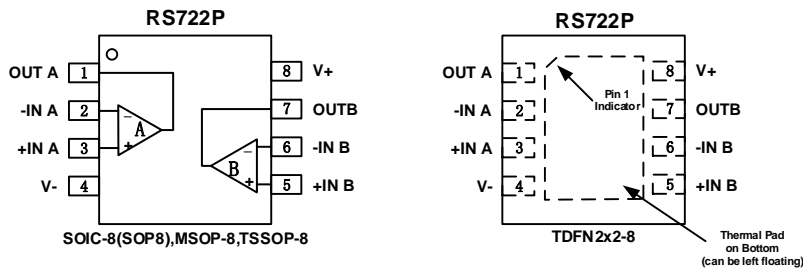

Pin Description

NAME	PIN	I/O	DESCRIPTION
	SOIC-8(SOP8)/MSOP8/ TSSOP-8/TDFN2×2-8		
-INA	2	I	Inverting input, channel A
+INA	3	I	Noninverting input, channel A
-INB	6	I	Inverting input, channel B
+INB	5	I	Noninverting input, channel B
OUTA	1	O	Output, channel A
OUTB	7	O	Output, channel B
V-	4	-	Negative (lowest) power supply
V+	8	-	Positive (highest) power supply

Pin Configuration and Functions (Top View)

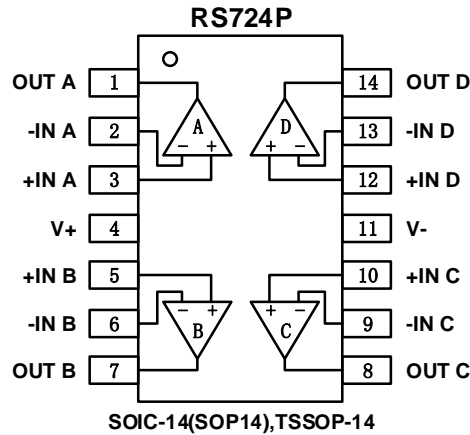

Pin Description

NAME	PIN	I/O	DESCRIPTION
	SOIC-14(SOP14)/TSSOP-14		
-INA	2	I	Inverting input, channel A
+INA	3	I	Noninverting input, channel A
-INB	6	I	Inverting input, channel B
+INB	5	I	Noninverting input, channel B
-INC	9	I	Inverting input, channel C
+INC	10	I	Noninverting input, channel C
-IND	13	I	Inverting input, channel D
+IND	12	I	Noninverting input, channel D
OUTA	1	O	Output, channel A
OUTB	7	O	Output, channel B
OUTC	8	O	Output, channel C
OUTD	14	O	Output, channel D
V-	11	-	Negative (lowest) power supply
V+	4	-	Positive (highest) power supply



SPECIFICATIONS

Absolute Maximum Ratings

Over operating free-air temperature range (unless otherwise noted) ⁽¹⁾

		MIN	MAX	UNIT
Voltage	Supply, $V_s=(V+) - (V-)$		7	V
	Signal input pin ⁽²⁾	(V-)-0.5	(V+) + 0.5	
	Signal output pin ⁽³⁾	(V-)-0.5	(V+) + 0.5	
Current	Signal input pin ⁽²⁾	-10	10	mA
	Signal output pin ⁽³⁾	-150	150	mA
	Output short-circuit ⁽⁴⁾	Continuous		
Temperature	Operating range, T_A	-40	125	°C
	Junction, T_J		150	
	Storage, T_{stg}	-65	150	

- (1) Stresses above these ratings may cause permanent damage. Exposure to absolute maximum conditions for extended periods may degrade device reliability. These are stress ratings only, and functional operation of the device at these or any other conditions beyond those specified is not implied.
- (2) Input terminals are diode-clamped to the power-supply rails. Input signals that can swing more than 0.5V beyond the supply rails should be current-limited to 10mA or less.
- (3) Output terminals are diode-clamped to the power-supply rails. Output signals that can swing more than 0.5V beyond the supply rails should be current-limited to ± 150 mA or less.
- (4) Short-circuit to ground, one amplifier per package.

ESD Ratings

			VALUE	UNIT
$V_{(ESD)}$	Electrostatic discharge	Human-body model (HBM)	3000	V
		Machine Model (MM)	200	

Recommended Operating Conditions

Over operating free-air temperature range (unless otherwise noted)

		MIN	NOM	MAX	UNIT
Supply voltage, $V_s= (V+) - (V-)$	Signal-supply	2.5		5.5	V
	Dual-supply	± 1.25		± 2.75	
Specified temperature		-40		125	°C

Thermal Information:RS721P

THERMAL METRIC ⁽¹⁾		RS721P				UNIT
		5PINS		8PINS		
		SOT23-5	SOT353 (SC70-5)	SOIC-8	MSOP8	
$R_{\theta JA}$	Junction-to-ambient thermal resistance	273.8	214.7	116	165	°C/W
$R_{\theta JC(top)}$	Junction-to-case(top) thermal resistance	126.8	127.1	60	53	°C/W
$R_{\theta JB}$	Junction-to-board thermal resistance	85.9	60.0	56	87	°C/W
Ψ_{JT}	Junction-to-top characterization parameter	10.9	33.4	12.8	4.9	°C/W
Ψ_{JB}	Junction-to-board characterization parameter	84.9	59.8	98.3	85	°C/W
$R_{\theta JC(bot)}$	Junction-to-case(bottom) thermal resistance	N/A	N/A	N/A	N/A	°C/W



RS721P, RS722P, RS724P

Thermal Information:RS722P

THERMAL METRIC ⁽¹⁾		RS722P				UNIT
		8PINS				
		SOIC-8	MSOP8	TSSOP-8	TDFN2×2-8	
R _{θJA}	Junction-to-ambient thermal resistance	116	165	192	80.1	°C/W
R _{θJC(top)}	Junction-to-case(top) thermal resistance	60	53	64.3	100	°C/W
R _{θJB}	Junction-to-board thermal resistance	56	87	105.3	45	°C/W
Ψ _{JT}	Junction-to-top characterization parameter	12.8	4.9	7.6	6.8	°C/W
Ψ _{JB}	Junction-to-board characterization parameter	98.3	85	105.5	45.2	°C/W
R _{θJC(bot)}	Junction-to-case(bottom) thermal resistance	N/A	N/A	N/A	22.7	°C/W

Thermal Information:RS724P

THERMAL METRIC ⁽¹⁾		RS724P		UNIT
		14PINS		
		SOIC-14	TSSOP-14	
R _{θJA}	Junction-to-ambient thermal resistance	83.8	120.8	°C/W
R _{θJC(top)}	Junction-to-case(top) thermal resistance	70.7	34.3	°C/W
R _{θJB}	Junction-to-board thermal resistance	59.5	62.8	°C/W
Ψ _{JT}	Junction-to-top characterization parameter	11.6	1	°C/W
Ψ _{JB}	Junction-to-board characterization parameter	37.7	56.5	°C/W
R _{θJC(bot)}	Junction-to-case(bottom) thermal resistance	N/A	N/A	°C/W



PACKAGE/ORDERING INFORMATION

Orderable Device	Package Type	Pin	Channel	Op Temp(°C)	Device Marking	Package Qty
RS721PXF	SOT23-5	5	1	-40°C ~125°C	721P	Tape and Reel,3000
RS721PXC5	SOT353(SC70-5)	5	1	-40°C ~125°C	721P	Tape and Reel,3000
RS721BPXF	SOT23-5	5	1	-40°C ~125°C	721BP	Tape and Reel,3000
RS721BPXC5	SOT353(SC70-5)	5	1	-40°C ~125°C	721BP	Tape and Reel,3000
RS721PXK	SOIC-8(SOP8)	8	1	-40°C ~125°C	RS721P	Tape and Reel,2500
RS721PXM	MSOP-8	8	1	-40°C ~125°C	RS721P	Tape and Reel,3000
RS722PXK	SOIC-8(SOP8)	8	2	-40°C ~125°C	RS722P	Tape and Reel,2500
RS722PXM	MSOP-8	8	2	-40°C ~125°C	RS722P	Tape and Reel,3000
RS722PXQ	TSSOP-8	8	2	-40°C~125°C	RS722P	Tape and Reel,3000
RS722PXTDE8	TDFN2x2-8	8	2	-40°C ~125°C	RS722P	Tape and Reel,3000
RS724PXP	SOIC-14(SOP14)	14	4	-40°C ~125°C	RS724P	Tape and Reel,2500
RS724PXQ	TSSOP-14	14	4	-40°C ~125°C	RS724P	Tape and Reel,3000



RS721P, RS722P, RS724P

ELECTRICAL CHARACTERISTICS

(At $T_A = +25^\circ\text{C}$, $V_S = 5\text{V}$, $R_L = 10\text{k}\Omega$ connected to $V_S/2$, and $V_{OUT} = V_S/2$, unless otherwise noted.)

PARAMETER	CONDITIONS	T_J	RS721P, RS722P, RS724P			UNITS		
			MIN	TYP	MAX			
POWER SUPPLY								
V_S	Operating Voltage Range		25°C	2.5		5.5	V	
I_Q	Quiescent Current/Amplifier		25°C		1.1	1.55	mA	
PSRR	Power-Supply Rejection Ratio	$V_S = 2.5\text{V to } 5.5\text{V}$, $V_{CM} = (V_-) + 0.5\text{V}$	25°C	75	97		dB	
			-40°C to 125°C	65				
T_{on}	Turn-on Time		25°C		13		us	
INPUT								
V_{os}	Input Offset Voltage	$V_{CM} = V_S/2$	25°C	-0.8	± 0.3	0.8	mV	
$V_{os\ TC}$	Input Offset Voltage Average Drift	-40°C to 125°C			2.6		$\mu\text{V}/^\circ\text{C}$	
I_B	Input Bias Current		25°C		1	10	pA	
I_{os}	Input Offset Current		25°C		1	10	pA	
V_{CM}	Common-Mode Voltage Range	$V_S = 5.5\text{V}$	25°C	-0.2		5.7	V	
CMRR	Common-Mode Rejection Ratio	$V_S = 5.5\text{V}$, $V_{CM} = -0.2\text{V to } 4\text{V}$	25°C	77	97		dB	
			-40°C to 125°C	67				
			25°C	65	81			
			-40°C to 125°C	57				
OUTPUT								
AOL	Open-Loop Voltage Gain	$R_L = 2\text{k}\Omega$, $V_O = 0.15\text{V to } 4.85\text{V}$	25°C	95	103		dB	
			-40°C to 125°C	65				
			$R_L = 10\text{k}\Omega$, $V_O = 0.05\text{V to } 4.95\text{V}$	25°C	100	110		
			-40°C to 125°C	66				
	Output Swing From Rail	$R_L = 2\text{k}\Omega$	25°C		12		mV	
				$R_L = 10\text{k}\Omega$		3		
I_{out}	Output Current Source		25°C		140		mA	
FREQUENCY RESPONSE								
SR	Slew Rate		25°C		6		V/us	
GBP	Gain-Bandwidth Product		25°C		10		MHz	
PM	Phase Margin		25°C		62		°	
t_s	Setting Time, 0.1%		25°C		0.7		us	
	Overload Recovery Time	$V_{IN} \cdot \text{Gain} \geq V_S$, $G = -100$	25°C		3.2		us	
NOISE								
e_n	Input Voltage Noise Density	$f = 1\text{KHz}$	25°C		9.5		$\text{nV}/\sqrt{\text{Hz}}$	
		$f = 10\text{KHz}$	25°C		6.5		$\text{nV}/\sqrt{\text{Hz}}$	



TYPICAL CHARACTERISTICS

At $T_A = +25^\circ\text{C}$, $V_S = 5\text{V}$, $R_L = 10\text{k}\Omega$ connected to $V_S/2$, $V_{OUT} = V_S/2$, unless otherwise noted.

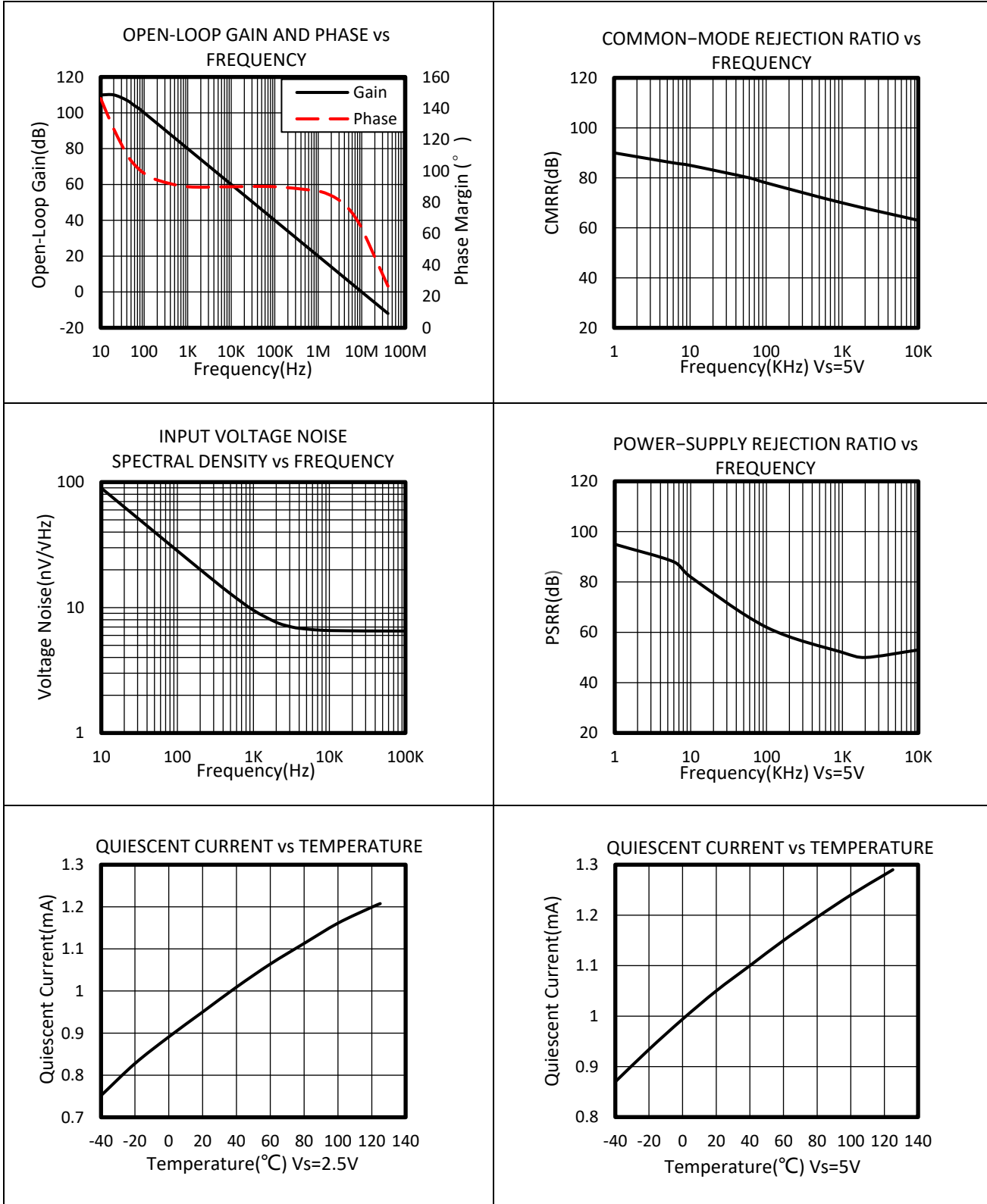



TYPICAL CHARACTERISTICS

At $T_A = +25^\circ\text{C}$, $V_S = 5\text{V}$, $R_L = 10\text{k}\Omega$ connected to $V_S/2$, $V_{OUT} = V_S/2$, unless otherwise noted.

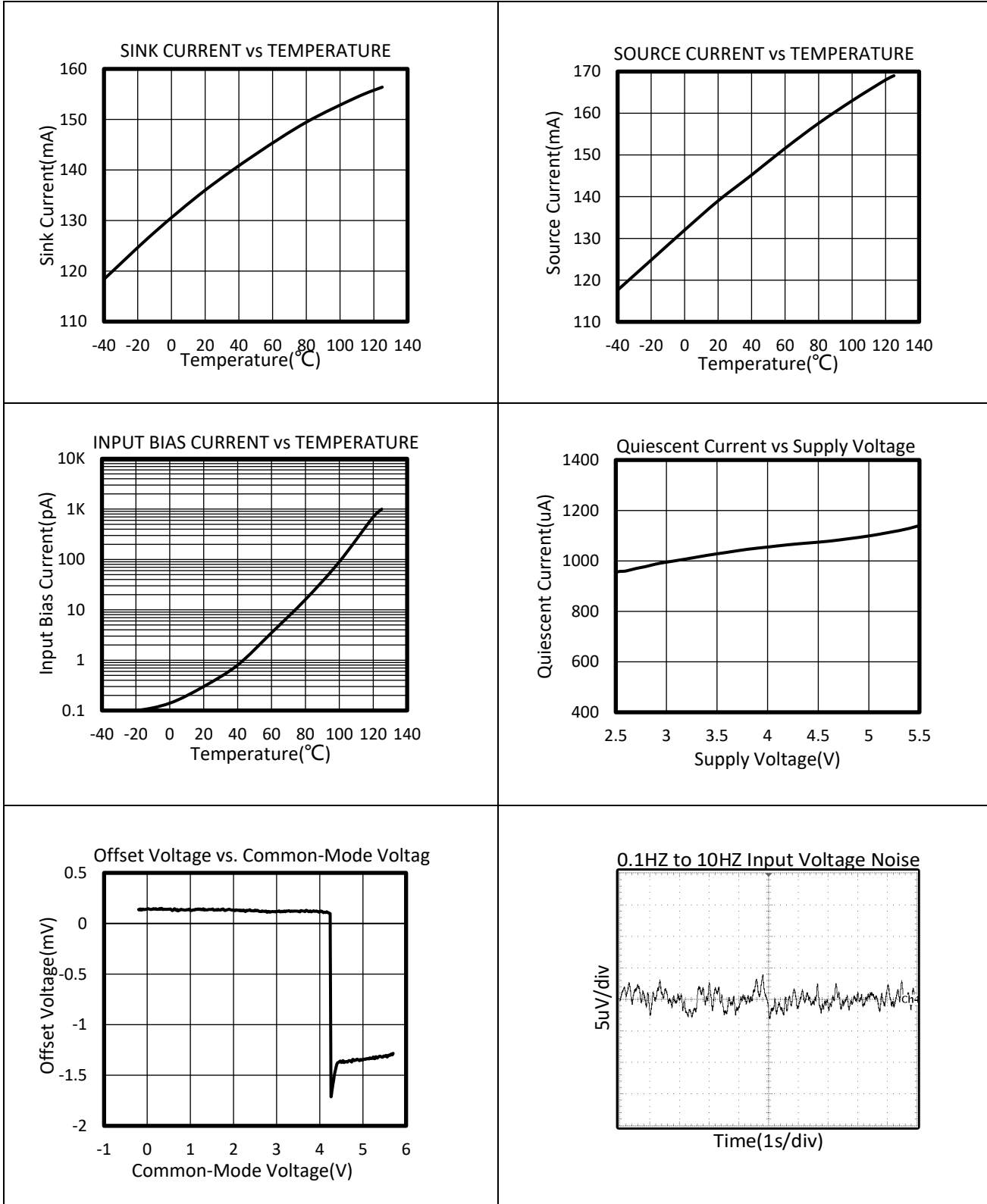



TYPICAL CHARACTERISTICS

At $T_A = +25^\circ\text{C}$, $V_S = 5\text{V}$, $R_L = 10\text{k}\Omega$ connected to $V_S/2$, $V_{OUT} = V_S/2$, unless otherwise noted.

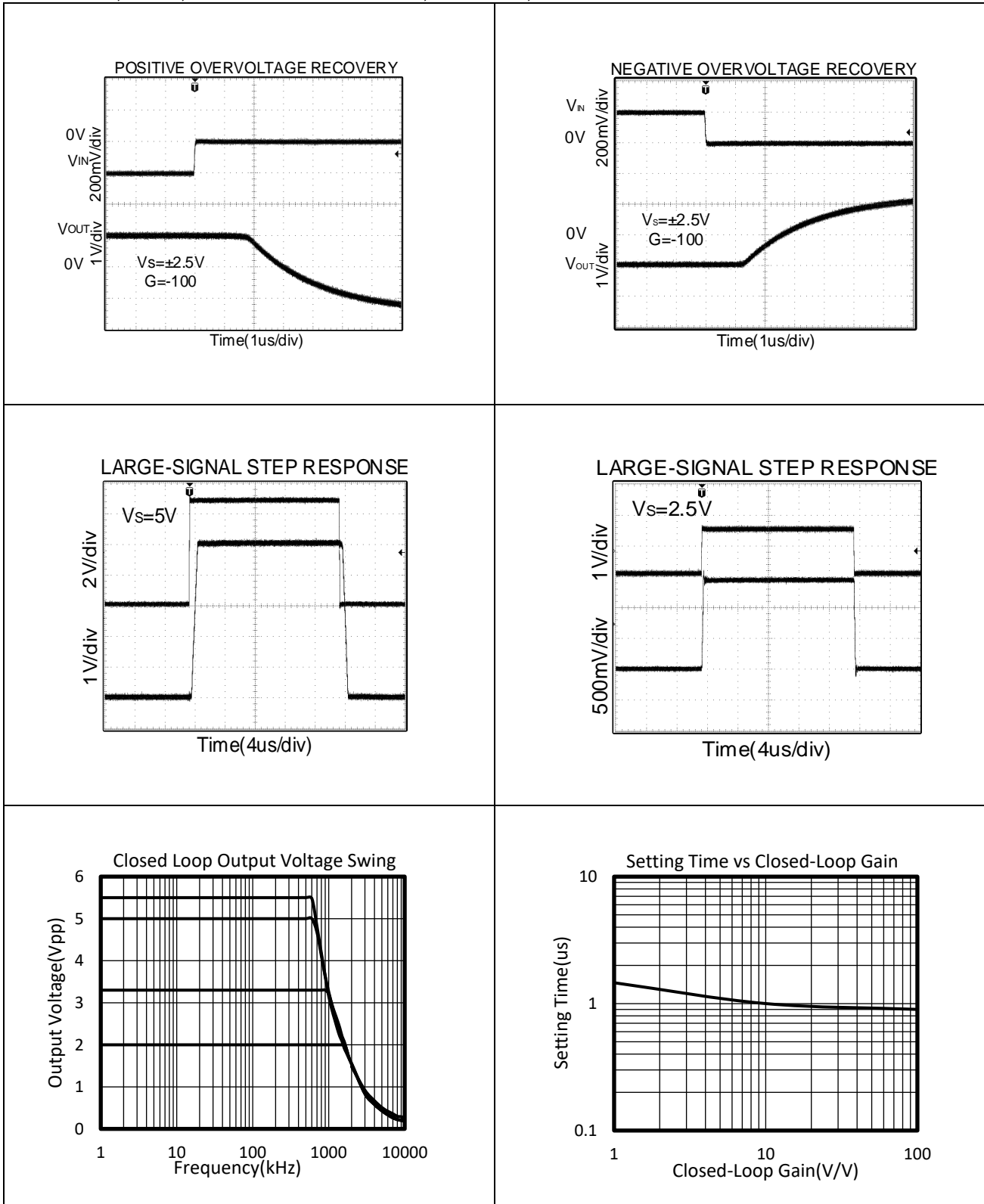



TYPICAL CHARACTERISTICS

At $T_A = +25^\circ\text{C}$, $V_S = 5\text{V}$, $R_L = 10\text{k}\Omega$ connected to $V_S/2$, $V_{OUT} = V_S/2$, unless otherwise noted.

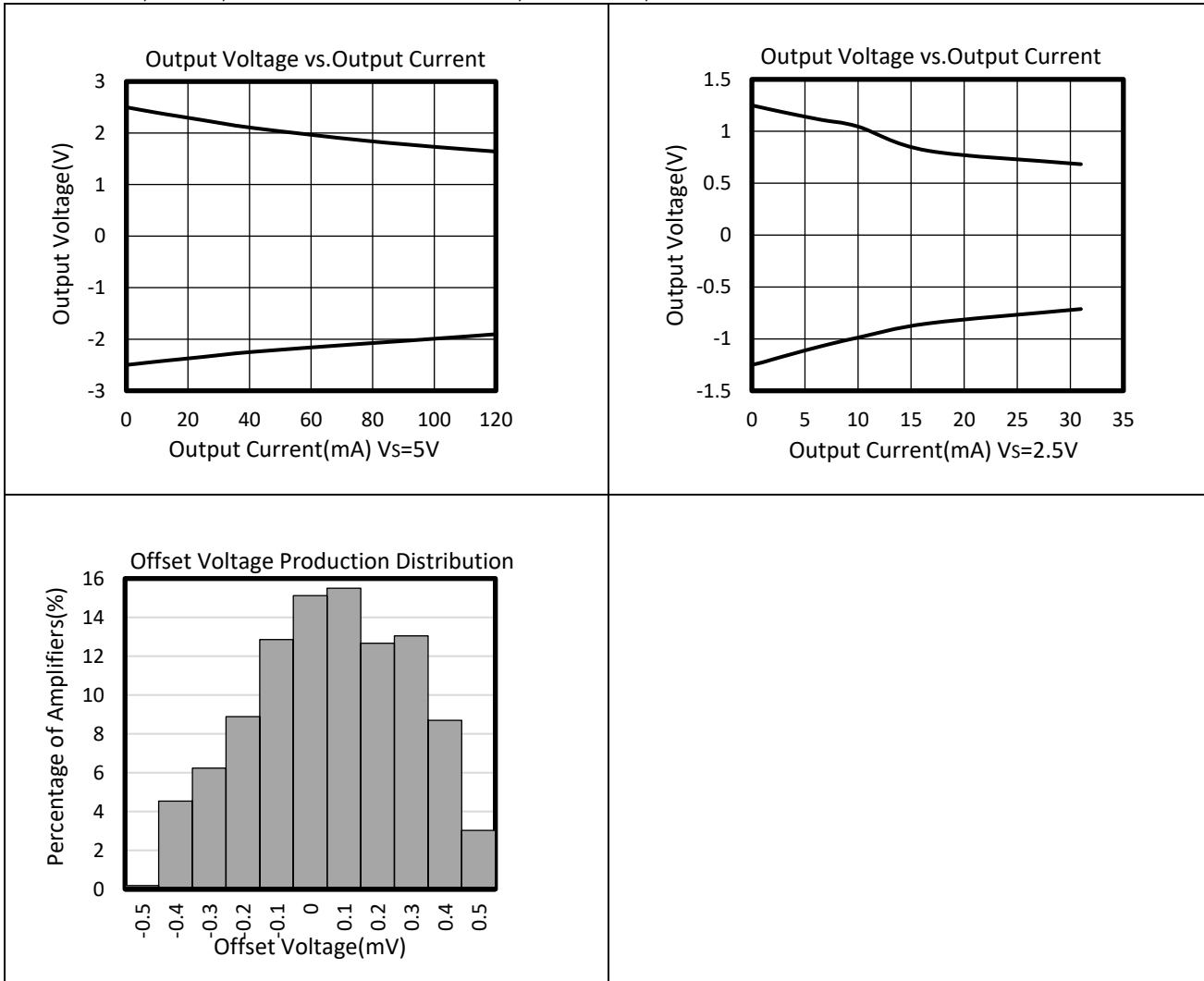

Detailed Description

Overview

The RS72XP devices are unity-gain stable, dual and quad-channel op amps with low noise and distortion. The device consists of a low noise input stage with a folded cascade and a rail-to-rail output stage. This topology exhibits superior noise and distortion performance across a wide range of supply voltages that are not delivered by legacy commodity audio operational amplifiers.

Phase Reversal Protection

The RS72XP family has internal phase-reversal protection. Many op amps exhibit phase reversal when the input is driven beyond the linear common-mode range. This condition is most often encountered in noninverting circuits when the input is driven beyond the specified common-mode voltage range, causing the output to reverse into the opposite rail. The input of the RS72XP prevents phase reversal with excessive common-mode voltage. Instead, the appropriate rail limits the output voltage. This performance is shown in figure 1.

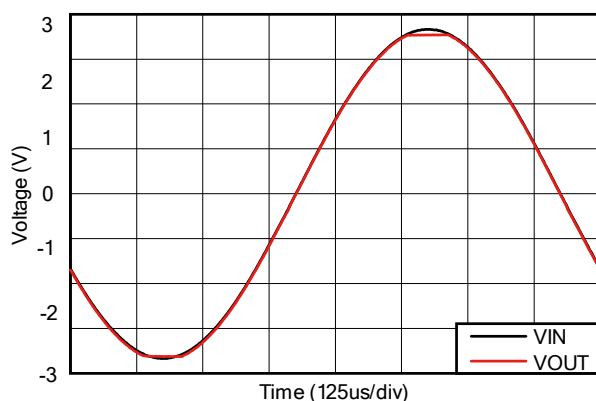

Figure 1. Output Waveform Devoid of Phase Reversal During an Input Overdrive Condition

EMI Rejection Ratio (EMIRR)

The electromagnetic interference (EMI) rejection ratio, or EMIRR, describes the EMI immunity of operational amplifiers. An adverse effect that is common to many operational amplifiers is a change in the offset voltage as a result of RF signal rectification. An operational amplifier that is more efficient at rejecting this change in offset as a result of EMI has a higher EMIRR and is quantified by a decibel value. Measuring EMIRR can be performed in many ways, but this document provides the EMIRR IN+, which specifically describes the EMIRR performance when the RF signal is applied to the noninverting input pin of the operational amplifier. In general, only the noninverting input is tested for EMIRR for the following three reasons:

- Operational amplifier input pins are known to be the most sensitive to EMI, and typically rectify RF signals better than the supply or output pins.
- The noninverting and inverting operational amplifier inputs have symmetrical physical layouts and exhibit nearly matching EMIRR performance.
- EMIRR is easier to measure on noninverting pins than on other pins because the noninverting input pin can be isolated on a printed-circuit-board (PCB). This isolation allows the RF signal to be applied directly to the noninverting input pin with no complex interactions from other components or connecting PCB traces.

Detailed Description (continued)

The EMIRR IN+ of the RS72XP is plotted versus frequency in Figure 2. If available, any dual and quad operational amplifier device versions have approximately identical EMIRR IN+ performance. The RS72XP unity-gain bandwidth is 10MHz. EMIRR performance below this frequency denotes interfering signals that fall within the operational amplifier bandwidth.

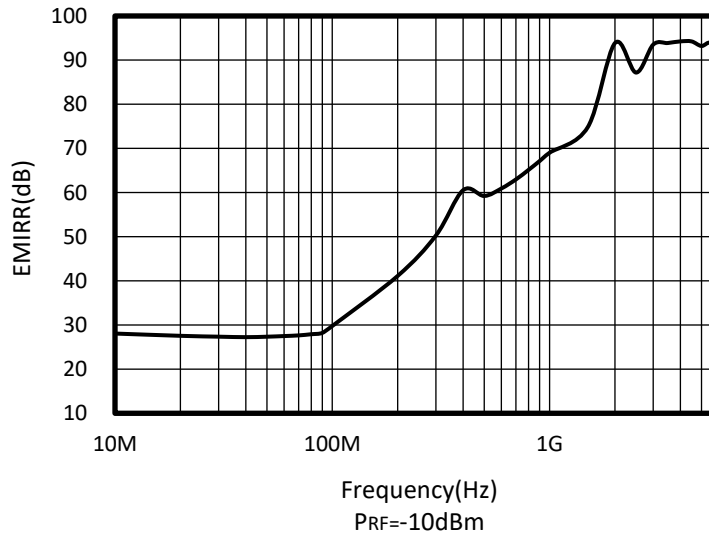

Figure 2. RS72XP EMIRR vs Frequency

EMIRR IN+ Test Configuration

Figure 3 shows the circuit configuration for testing the EMIRR IN+. An RF source is connected to the operational amplifier noninverting input pin using a transmission line. The operational amplifier is configured in a unity-gain buffer topology with the output connected to a low-pass filter (LPF) and a digital multimeter (DMM). A large impedance mismatch at the operational amplifier input causes a voltage reflection; however, this effect is characterized and accounted for when determining the EMIRR IN+. The resulting dc offset voltage is sampled and measured by the multimeter. The LPF isolates the multimeter from residual RF signals that can interfere with multimeter accuracy.

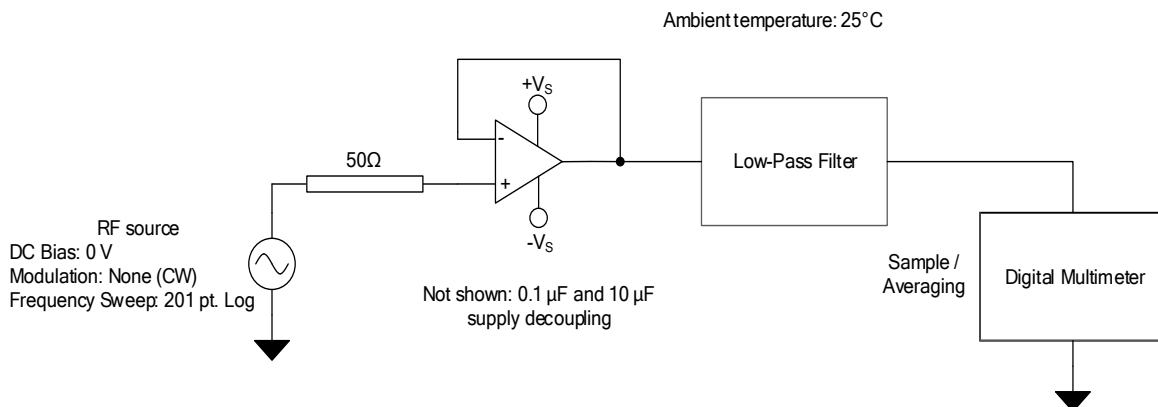

Figure 3. EMIRR IN+ Test Configuration Schematic

APPLICATION NOTE

The RS721P, RS722P, RS724P are high precision, rail-to-rail operational amplifiers that can be run from a single-supply voltage 2.5V to 5.5V ($\pm 1.25V$ to $\pm 2.75V$). Supply voltages higher than 7V (absolute maximum) can permanently damage the amplifier. Rail-to-rail input and output swing significantly increases dynamic range, especially in low-supply applications. Good layout practice mandates use of a 0.1 μ F capacitor placed closely across the supply pins.

Typical Applications

25-kHz Low-pass Filter

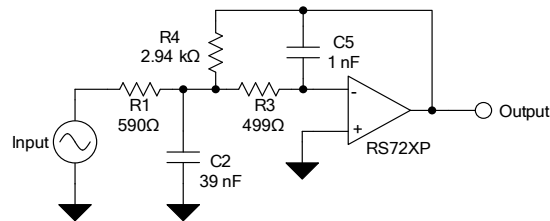

Figure 4. 25-kHz Low-Pass Filter

Design Requirements

Low-pass filters are commonly employed in signal processing applications to reduce noise and prevent aliasing. The RS72XP devices are ideally suited to construct high-speed, high-precision active filters. Figure 4 shows a second-order, low-pass filter commonly encountered in signal processing applications.

Use the following parameters for this design example:

- Gain = 5 V/V (inverting gain)
- Low-pass cutoff frequency = 25 kHz
- Second-order Chebyshev filter response with 3-dB gain peaking in the passband

Detailed Design Procedure

The infinite-gain multiple-feedback circuit for a low-pass network function is shown in Figure 4. Use Equation 1 to calculate the voltage transfer function.

$$\frac{\text{Output}}{\text{Input}}(s) = \frac{-1/R_1 R_3 C_2 C_5}{s^2 + (s/C_2) (1/R_1 + 1/R_3 + 1/R_4) + 1/R_3 R_4 C_2 C_5} \quad (1)$$

This circuit produces a signal inversion. For this circuit, the gain at dc and the low-pass cutoff frequency are calculated by Equation 2:

$$\text{Gain} = \frac{R_4}{R_1}$$

$$f_c = \frac{1}{2\pi} \sqrt{1/R_3 R_4 C_2 C_5}$$

(2)

Application Curve

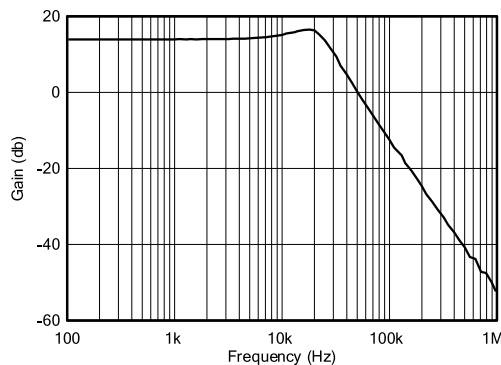

Figure 5. Low-pass filter transfer function

LAYOUT

Layout Guideline

Attention to good layout practices is always recommended. Keep traces short. When possible, use a PCB ground plane with surface-mount components placed as close to the device pins as possible. Place a 0.1 μ F capacitor closely across the supply pins.

These guidelines should be applied throughout the analog circuit to improve performance and provide benefits such as reducing the EMI susceptibility.

Layout Example

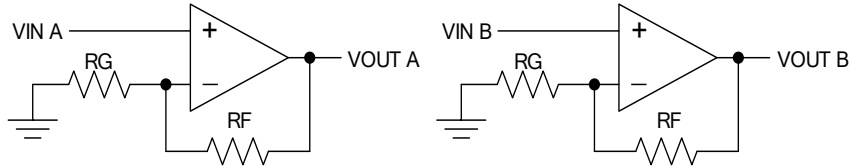

Figure 6. Schematic Representation

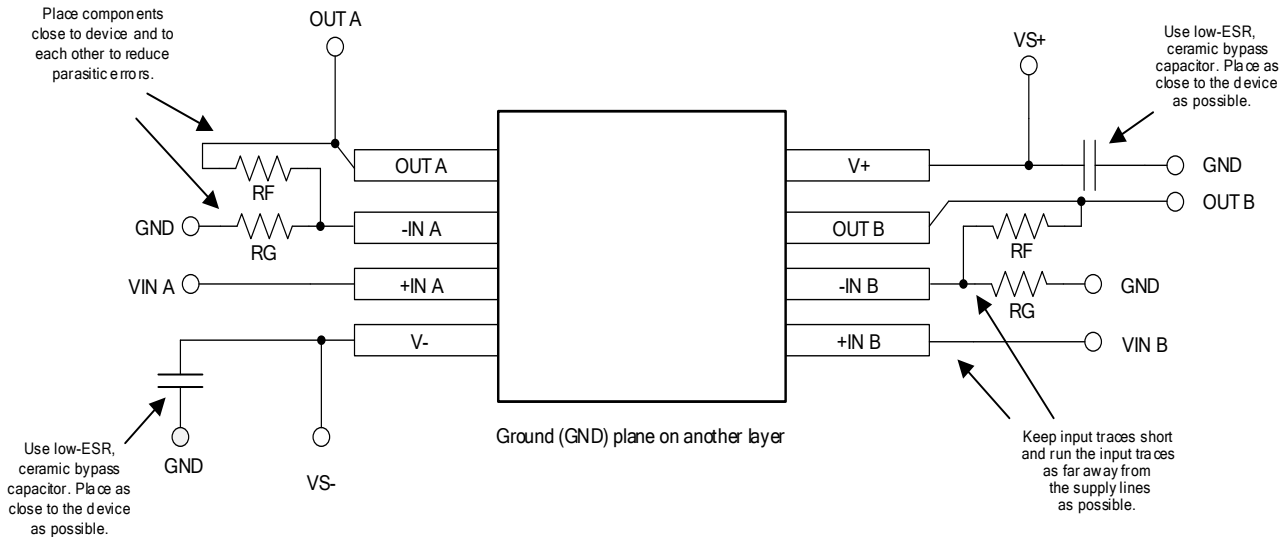
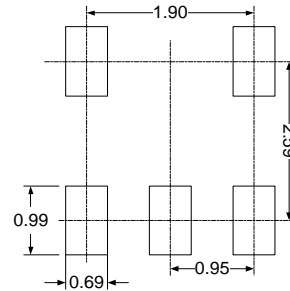
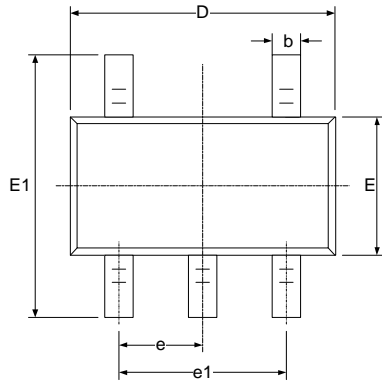
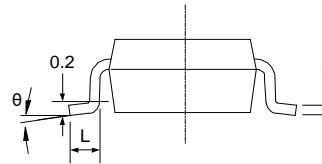
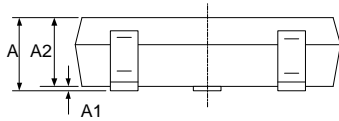

Figure 7. Layout Example

PACKAGE OUTLINE DIMENSIONS SOT23-5



RECOMMENDED LAND PATTERN (Unit: mm)



Symbol	Dimensions In Millimeters		Dimensions In Inches	
	Min	Max	Min	Max
A	1.050	1.250	0.041	0.049
A1	0.000	0.100	0.000	0.004
A2	1.050	1.150	0.041	0.045
b	0.300	0.500	0.012	0.020
c	0.100	0.200	0.004	0.008
D	2.820	3.020	0.111	0.119
E	1.500	1.700	0.059	0.067
E1	2.650	2.950	0.104	0.116
e	0.950(BSC)		0.037(BSC)	
e1	1.800	2.000	0.071	0.079
L	0.300	0.600	0.012	0.024
θ	0°	8°	0°	8°

SOT353(SC70-5)

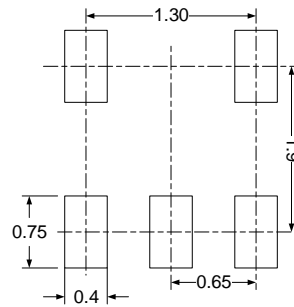
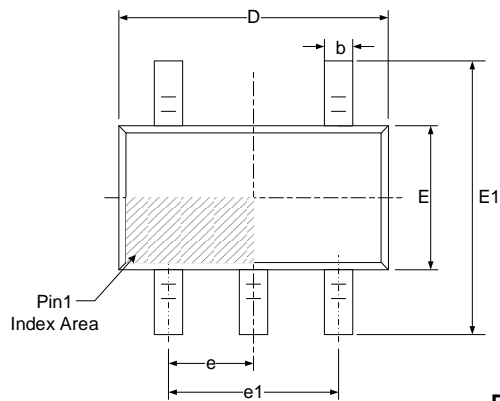

RECOMMENDED LAND PATTERN (Unit: mm)

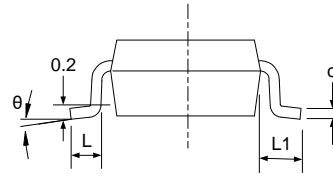
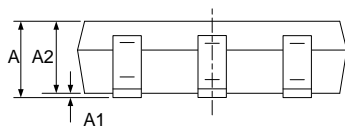

Symbol	Dimensions In Millimeters		Dimensions In Inches	
	Min	Max	Min	Max
A	0.900	1.100	0.035	0.043
A1	0.000	0.100	0.000	0.004
A2	0.900	1.000	0.035	0.039
b	0.150	0.350	0.006	0.014
c	0.080	0.150	0.003	0.006
D	2.000	2.200	0.079	0.087
E	1.150	1.350	0.045	0.053
E1	2.150	2.450	0.085	0.096
e	0.650(BSC)		0.026(BSC)	
e1	1.300(BSC)		0.051(BSC)	
L	0.260	0.460	0.010	0.018
L1	0.525		0.021	
θ	0°	8°	0°	8°

MSOP-8

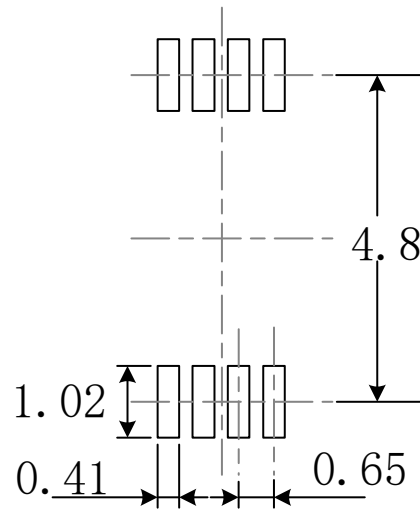
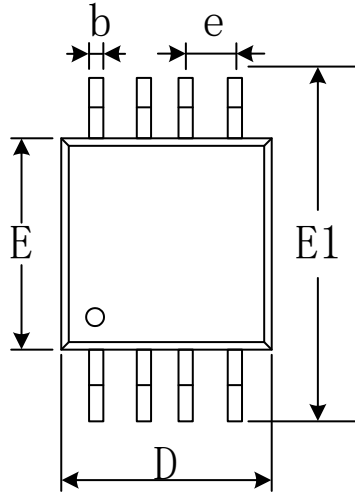

RECOMMENDED LAND PATTERN (Unit: mm)

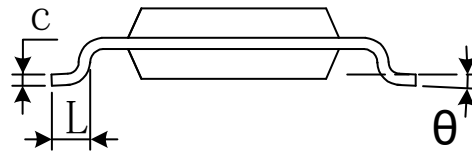
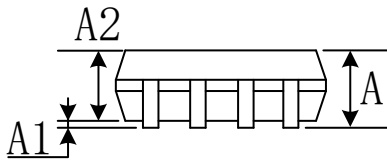

Symbol	Dimensions In Millimeters		Dimensions In Inches	
	Min	Max	Min	Max
A	0.820	1.100	0.032	0.043
A1	0.020	0.150	0.001	0.006
A2	0.750	0.950	0.030	0.037
b	0.250	0.380	0.010	0.015
c	0.090	0.230	0.004	0.009
D	2.900	3.100	0.114	0.122
e	0.650(BSC)		0.026(BSC)	
E	2.900	3.100	0.114	0.122
E1	4.750	5.050	0.187	0.199
L	0.400	0.800	0.016	0.031
θ	0°	6°	0°	6°

TSSOP-14

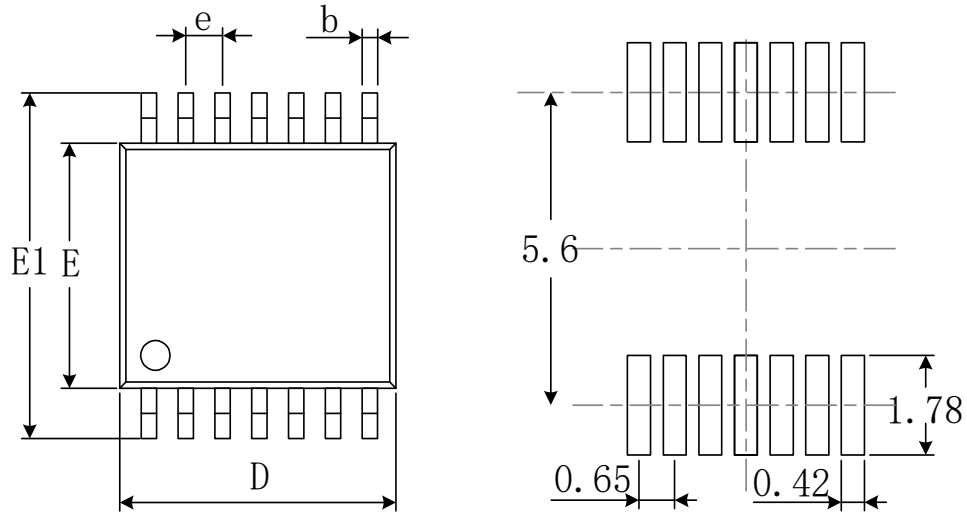

RECOMMENDED LAND PATTERN (Unit: mm)

Symbol	Dimensions In Millimeters		Dimensions In Inches	
	Min	Max	Min	Max
A		1.200		0.047
A1	0.050	0.150	0.002	0.006
A2	0.800	1.050	0.031	0.041
b	0.190	0.300	0.007	0.012
c	0.090	0.200	0.004	0.008
D	4.860	5.100	0.191	0.201
E	4.300	4.500	0.169	0.177
E1	6.250	6.550	0.246	0.258
e	0.650(BSC)		0.026(BSC)	
L	0.500	0.700	0.020	0.028
H	0.25(TYP)		0.01(TYP)	
θ	1°	7°	1°	7°

SOIC-8(SOP8)

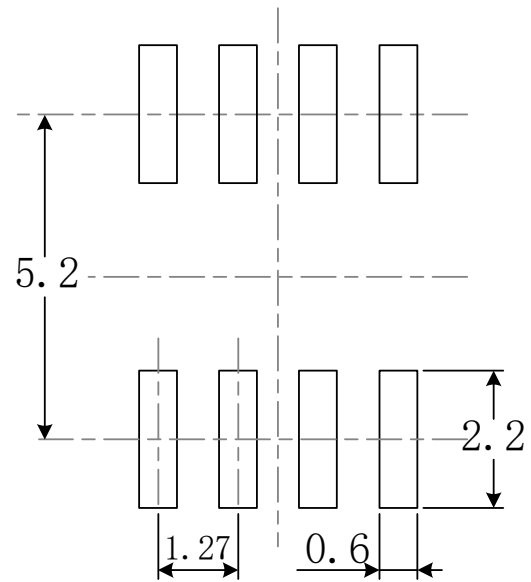
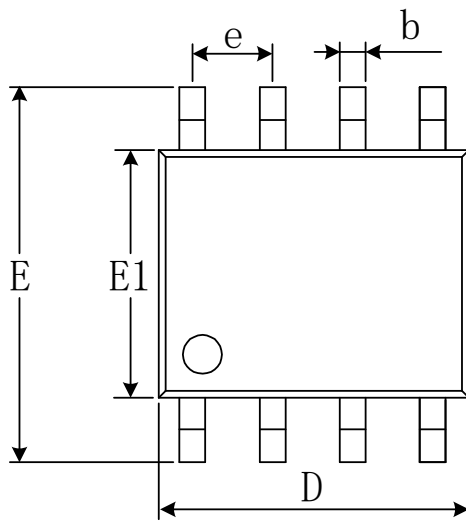

RECOMMENDED LAND PATTERN (Unit: mm)

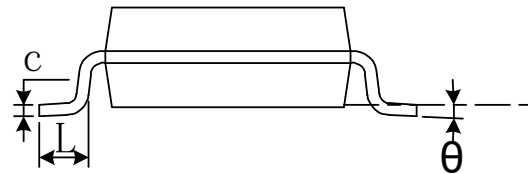
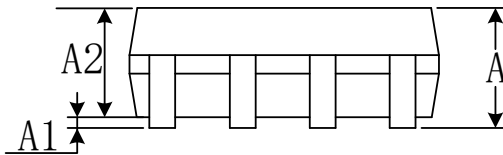

Symbol	Dimensions In Millimeters		Dimensions In Inches	
	Min	Max	Min	Max
A	1.350	1.750	0.053	0.069
A1	0.100	0.250	0.004	0.010
A2	1.350	1.550	0.053	0.061
b	0.330	0.510	0.013	0.020
c	0.170	0.250	0.007	0.010
D	4.800	5.000	0.189	0.197
e	1.270(BSC)		0.050(BSC)	
E	5.800	6.200	0.228	0.244
E1	3.800	4.000	0.150	0.157
L	0.400	1.270	0.016	0.050
θ	0°	8°	0°	8°

SOIC-14(SOP14)

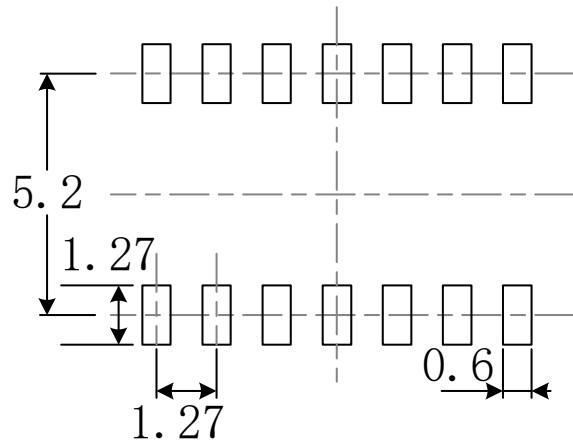
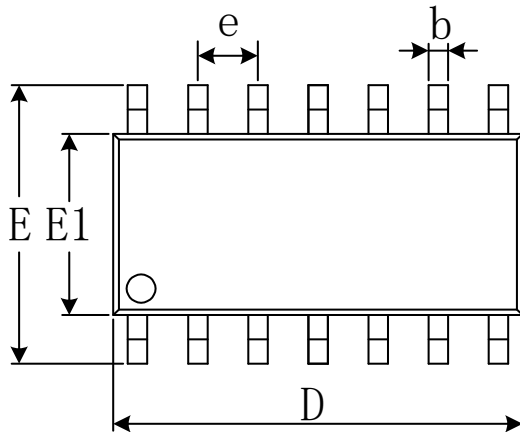

RECOMMENDED LAND PATTERN (Unit: mm)

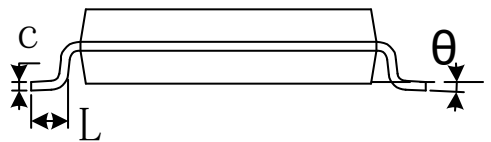
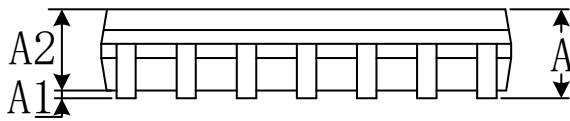

Symbol	Dimensions In Millimeters		Dimensions In Inches	
	Min	Max	Min	Max
A	1.350	1.750	0.053	0.069
A1	0.100	0.250	0.004	0.010
A2	1.350	1.550	0.053	0.061
b	0.310	0.510	0.012	0.020
c	0.100	0.250	0.004	0.010
D	8.450	8.850	0.333	0.348
e	1.270(BSC)		0.050(BSC)	
E	5.800	6.200	0.228	0.244
E1	3.800	4.000	0.150	0.157
L	0.400	1.270	0.016	0.050
θ	0°	8°	0°	8°

TSSOP-8

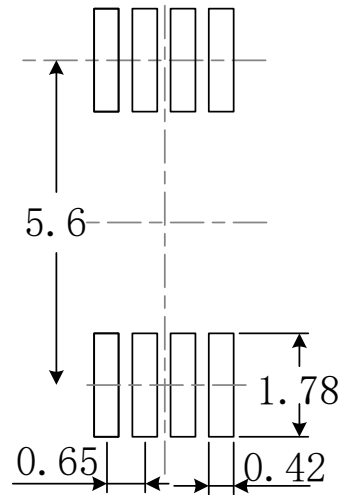
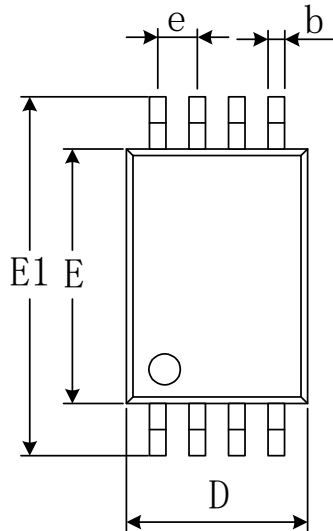

RECOMMENDED LAND PATTERN (Unit: mm)

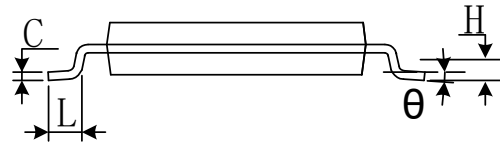
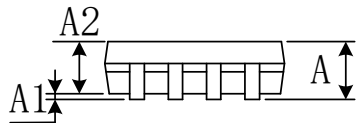

Symbol	Dimensions In Millimeters		Dimensions In Inches	
	Min	Max	Min	Max
A		1.200		0.047
A1	0.050	0.150	0.002	0.006
A2	0.800	1.050	0.031	0.041
b	0.190	0.300	0.007	0.012
c	0.090	0.200	0.004	0.008
D	2.900	3.100	0.114	0.122
E	4.300	4.500	0.169	0.177
E1	6.250	6.550	0.246	0.258
e	0.650(BSC)		0.026(BSC)	
L	0.500	0.700	0.020	0.028
H	0.25(TYP)		0.01(TYP)	
θ	1°	7°	1°	7°

TDFN2x2-8

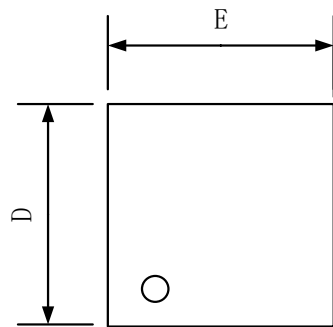

TOP VIEW

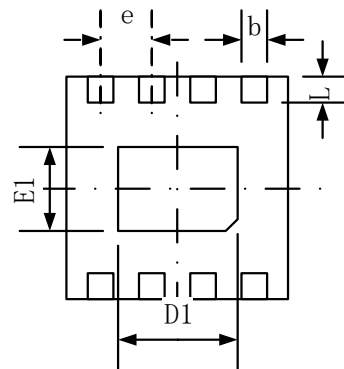

BOTTOM VIEW

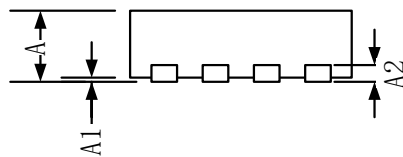

SIDE VIEW

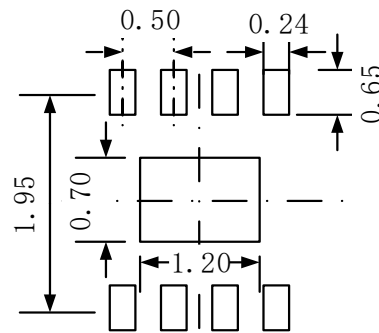
RECOMMENDED LAND
PATTERN (Unit: mm)

Symbol	Dimensions In Millimeters		Dimensions In Inches	
	Min	Max	Min	Max
A	0.700	0.800	0.028	0.031
A1	0.000	0.050	0.000	0.002
A2	0.203(TYP)		0.008(TYP)	
b	0.180	0.300	0.007	0.012
D	1.900	2.100	0.075	0.083
D1	1.100	1.300	0.043	0.051
E	1.900	2.100	0.075	0.083
E1	0.600	0.800	0.024	0.031
e	0.500(TYP)		0.020(TYP)	
L	0.250	0.450	0.010	0.018

OUR CERTIFICATE

DiGi provide top-quality products and perfect service for customer worldwide through standardization, technological innovation and continuous improvement. DiGi through third-party certification, we stricly control the quality of products and services. Welcome your RFQ to

Email: Info@DiGi-Electronics.com



Tel: +00 852-30501935

RFQ Email: Info@DiGi-Electronics.com

DiGi is a global authorized distributor of electronic components.