

# CL03C8R2BA3GNNH Datasheet

[www.digi-electronics.com](http://www.digi-electronics.com)

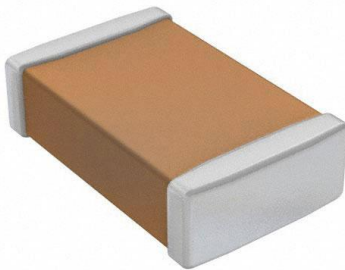

<https://www.DiGi-Electronics.com>

DiGi Electronics Part Number	CL03C8R2BA3GNNH-DG
Manufacturer	<a href="#">Samsung Electro-Mechanics</a>
Manufacturer Product Number	CL03C8R2BA3GNNH
Description	CAP CER 8.2PF 25V NP0 0201
Detailed Description	8.2 pF $\pm$ 0.1pF 25V Ceramic Capacitor COG, NP0 0201 (0603 Metric)

This model CL03C8R2BA3GNNH is available at DiGi Electronics.

DiGi Electronics offers a global database of semiconductor and electronic component datasheets.

We welcome your inquiries regarding pricing, lead time, or other product-related questions.

 [Request a Quote](#)

 [Datasheet Search](#)



Tel: +00 852-30501935

RFQ Email: [Info@DiGi-Electronics.com](mailto:Info@DiGi-Electronics.com)

DiGi is a global authorized distributor of electronic components.

## Purchase and inquiry

**Manufacturer Product Number:**

CL03C8R2BA3GNNH

**Series:**

CL

**Capacitance:**

8.2 pF

**Voltage - Rated:**

25V

**Operating Temperature:**

-55°C ~ 125°C

**Ratings:**

-

**Failure Rate:**

-

**Package / Case:**

0201 (0603 Metric)

**Height - Seated (Max):**

-

**Lead Spacing:**

-

**Manufacturer:**

Samsung Electro-Mechanics

**Product Status:**

Active

**Tolerance:**

±0.1pF

**Temperature Coefficient:**

COG, NP0

**Features:**

-

**Applications:**

General Purpose

**Mounting Type:**

Surface Mount, MLCC

**Size / Dimension:**

0.024" L x 0.012" W (0.60mm x 0.30mm)

**Thickness (Max):**

0.013" (0.33mm)

**Lead Style:**

-

## Environmental & Export classification

**RoHS Status:**

ROHS3 Compliant

**REACH Status:**

REACH Unaffected

**HTSUS:**

8532.24.0020

**Moisture Sensitivity Level (MSL):**

1 (Unlimited)

**ECCN:**

EAR99

January 2024



# MULTILAYER CERAMIC CAPACITORS

**SAMSUNG**  
ELECTRO-MECHANICS



# MULTILAYER CERAMIC CAPACITORS



## Interactive User Guide

Samsung Electro-Mechanics' MLCC Catalog was produced as an INTERACTIVE PDF that allows transferring to related webpages for better understanding of the content. Click 'HOME,' 'CONTENTS,' OR 'GO BACK TO PAGE' as needed, and it is also possible to 'PRINT' the pages. If you click the icon at the top of the page, it is possible to view a specific page of choice.



By clicking this icon, you can jump directly to the cover page of this catalog.



By clicking this icon, you can jump directly to the Table of Contents.



By clicking this icon, you can jump directly to the previous page.



By clicking this icon, you can set and print pages of your choice.

# C O N T E N T S

**04** Explanation of Ceramic Capacitors

**06** Part Numbering

**09** Reliability Level Description

**10** Normal Capacitors\_Standard

**80** Normal Capacitors\_High Level I

**102** Normal Capacitors\_High Level II

**107** Molded Frame Capacitors (MFC)

**108** Land Side Capacitors (LSC)

**110** High Bending Strength Capacitors

**116** Low Acoustic Noise Capacitors

**120** Low ESL Capacitors

**125** Application Guide

**129** Reliability Test Conditions

**135** Packaging Specifications

**141** Caution/Notice

**162** Disclaimer & Limitation of Use and Applications

**163** Component Sales Offices/Manufacturing Sites

# Explanation of Ceramic Capacitors

## Nomal Capacitors

Normal Capacitors

Standard

High Level I

High Level II

Improved Reliability  
(65°C, 90%RH, 1Vr, 500H)

Reinforced Reliability  
(85°C, 85%RH, 1Vr, 1000H)

## Molded Frame Capacitors

Solution for mechanical and thermal stress

## Land Side Capacitors

Lower thickness and space saving

LSC



# Explanation of Ceramic Capacitors

## High Bending Strength Capacitors

More Resistant to stress caused by board bending

High-bending  
Strength

## Low Acoustic Noise Capacitors

A solution that effectively reduces audible noise

Low Acoustic  
Noise

## Low ESL Capacitors

Space Saving & High Speed Energy Transfer

Low ESL

# Part Numbering

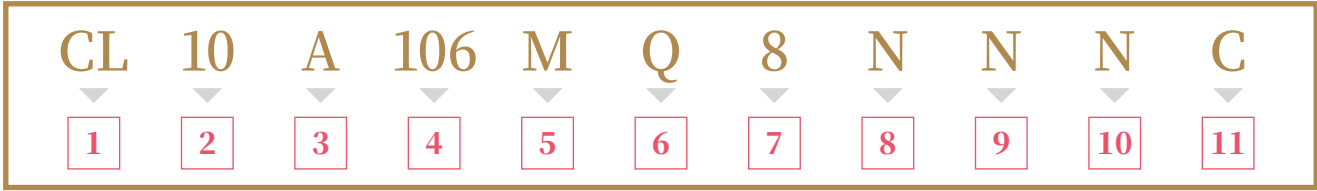

## 1 SERIES CODE

CL = Multilayer Ceramic Capacitors

## 2 SIZE CODE

Code	inch/mm	Code	inch/mm	Code	inch/mm	Code	inch/mm
R1	008004/0201	10	0603/1608	42	1808/4520	L6	0304/0610
02	01005/0402	21	0805/2012	43	1812/4532	01	0306/0816
03	0201/0603	31	1206/3216	55	2220/5750	19	0503/1209
05	0402/1005	32	1210/3225	L5	0204/0510		

## 3 DIELECTRIC CODE

Class I (Temperature Compensation)

Symbol	EIA Code	Operation Temperature Range (°C)	Temperature Coefficient Range (ppm/°C)
C	C0G	-55 ~ +125	0 ± 30
G	X8G	-55 ~ +150	0 ± 30

Class II (High Dielectric Constant)

Symbol	EIA Code	Operation Temperature Range (°C)	Capacitance Change (ΔC %)
A	X5R	-55 ~ +85	±15
X	X6S	-55 ~ +105	±22
W	X6T	-55 ~ +105	-33 ~ +22
B	X7R	-55 ~ +125	±15
K	X7R(S)	-55 ~ +125	±15
Y	X7S	-55 ~ +125	±22
Z	X7T	-55 ~ +125	-33 ~ +22
F	Y5V	-30 ~ +85	-82 ~ +22
M	X8M	-55 ~ +150	-50 ~ +50
E	X8L	-55 ~ +150	-40 ~ +15
J	JIS-B	-25 ~ +85	±10

\* X7R(S) = X7R (DC Bias 0.5Vr TCC)

## 4 CAPACITANCE CODE

Capacitance expressed in pF. 2 significant digits plus number of zeros.  
example) 106=10×10<sup>6</sup>=10,000,000pF

For Values < 10pF, Letter R denotes decimal point  
example) 1R5 = 1.5pF

## 5 CAPACITANCE TOLERANCE CODE

Code	Tolerance	Code	Tolerance	Code	Tolerance	Code	Tolerance
N	±0.03pF	H	+ 0.25pF	F	±1%	V	- 5%
A	±0.05pF	L	- 0.25pF	G	±2%	K	±10%
B	±0.1pF	D	±0.5pF	J	±5%	M	±20%
C	±0.25pF	F*	±1pF	U	+ 5%	Z	-20, +80%

\* For Values < 10pF, F=±1pF / Values≥10pF, F=±1%

**Part Numbering**

Reliability Level Description  
Normal Capacitors\_Standard  
Normal Capacitors\_High Level I  
Normal Capacitors\_High Level II

Land Side Capacitors (LSC)  
High Bending Strength Capacitors  
Low Acoustic Noise Capacitors  
Low ESL Capacitors  
Application Guide

Reliability Test Conditions  
Packaging Specifications  
Caution/Notice  
Disclaimer & Limitation of Use and Applications  
Component Sales Offices/  
Manufacturing Sites

# Part Numbering

Series	Nominal Capacitance											
E-3	1.0				2.2				4.7			
E-6	1.0		1.5		2.2		3.3		4.7		6.8	
E-12	1.0	1.2	1.5	1.8	2.2	2.7	3.3	3.9	4.7	5.6	6.8	8.2
E-24	1.0	1.2	1.5	1.8	2.2	2.7	3.3	3.9	4.7	5.6	6.8	8.2
	1.1	1.3	1.6	2.0	2.4	3.0	3.6	4.3	5.1	6.2	7.5	9.1

## 6 RATED VOLTAGE CODE

Code	Voltage	Code	Voltage	Code	Voltage	Code	Voltage
S	2.5Vdc	O	16Vdc	C	100Vdc	G	500Vdc
R	4.0Vdc	A	25Vdc	D	200Vdc	H	630Vdc
Q	6.3Vdc	L	35Vdc	E	250Vdc	I	1kVdc
P	10Vdc	B	50Vdc	F	350Vdc	J	2kVdc
						K	3kVdc

## 7 THICKNESS CODE

Size Code (inch/mm)	Code	Thickness	Tolerance	Size Code (inch/mm)	Code	Thickness	Tolerance
01005/0402	2	0.20	±0.02	1210/3225	C	0.85	±0.10*
0201/0603	3	0.30	±0.03		9	0.90	±0.10*
0402/1005	3	0.30	±0.03*		F	1.25	±0.20
	5	0.50	±0.05		S	1.35	±0.15*
0603/1608	5	0.50	+0.0/-0.1*		H	1.60	±0.20
	8	0.80	±0.10		U	1.80	±0.20*
0805/2012	A	0.65	±0.10		I	2.00	±0.20
	C	0.85	±0.10*		J	2.50	±0.20
	C	0.85	±0.10		V	2.50	±0.30
	M	1.15	±0.10		1808/4520	F	1.25
	F	1.25	±0.10	G		1.40	±0.20
	Q	1.25	±0.15	I		2.00	±0.20
1206/3216	Y	1.25	±0.20	1812/4532	F	1.25	±0.20
	C	0.85	±0.15		H	1.60	±0.20
		0.85	±0.10*		I	2.00	±0.20
	E	1.10	±0.15		J	2.50	±0.20
	E	1.10	±0.10*	L	3.20	±0.30	
	P	1.15	±0.10*	2220/5750	H	1.60	±0.20
	M	1.15	±0.15		I	2.00	±0.20
	F	1.25	±0.15		J	2.50	±0.20
H	1.6	±0.20	L		3.20	±0.30	

\* Mark is only applicable to "L","Y","F", 12th code in part number.

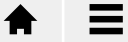

### ► Part Numbering

Reliability Level Description  
Normal Capacitors\_Standard  
Normal Capacitors\_High Level I  
Normal Capacitors\_High Level II

Land Side Capacitors (LSC)  
High Bending Strength Capacitors  
Low Acoustic Noise Capacitors  
Low ESL Capacitors  
Application Guide

Reliability Test Conditions  
Packaging Specifications  
Caution/Notice  
Disclaimer & Limitation of Use and Applications  
Component Sales Offices/  
Manufacturing Sites

# Part Numbering

## 8 INNER ELECTRODE/TERMINATION/PLATING CODE

Code	Thickness division	Inner electrode	Termination	Plating material
N	Normal	Ni	Cu	Ni / Sn _100%
G	Normal	Cu	Cu	Ni / Sn _100%
S	Normal	Ni	Metal Epoxy	Ni / Sn _100%
C	Normal	Ni	Control Code	Ni / Sn _100%
L	Low profile	Ni	Cu	Ni / Sn _100%
Y	Low profile	Ni	Metal Epoxy	Ni / Sn _100%
Z	Normal	Ni	Metal Epoxy	Ni / Sn _100%
F	Low profile	Ni	Metal Epoxy	Ni / Sn _100%

## 9 PRODUCT CODE OR SIZE CONTROL CODE

N=Normal

A=Array (2-element)

B=Array (4-element)

L=LICC (Low Inductance Ceramic Capacitor)

J=SLIC (Super Low Inductance Capacitor)

(Unit : inch/mm)

Code	Size	01005/0402	0201/0603	0402/1005	0603/1608	0805/2012	1206/3216
S		±0.03	±0.05	±0.07	±0.07		±0.30
Q		±0.05	±0.07	±0.10	±0.15	±0.15	
R		±0.07	±0.09	±0.15	±0.20	±0.20	
U		±0.09		±0.20	±0.25	±0.25	
Z				±0.40	±0.30	±0.30	
9				±0.30			

## 10 CONTROL CODE

N= Reserved for future use

## 11 PACKAGING CODE

### Cardboard Tape (paper)

Code	Taping Type
8/C/H	Normal, 7"reel (Quantity option)
J	1mm Pitch, 7"reel
Z	Chip aligned for horizontal, 7"reel
Y	Chip aligned for vertical, 7"reel
O	Normal, 10"reel
3/D/L	Normal, 13"reel (Quantity option)
2	1mm Pitch, 13"reel
7	Chip aligned for vertical, 13"reel

### Embossed Tape (plastic)

Code	Taping Type
E/G	Normal, 7"reel (Quantity option)
R	Chip aligned for horizontal, 7"reel
W	Chip aligned for vertical, 7"reel
S	Normal, 10"reel
F	Normal, 13"reel (Quantity option)

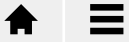

# Reliability Level Description

Reliability Level	Standard	High Level I	High Level II	AEC-Q200
AEC-Q200	N/A	N/A	N/A	Guarantee
Humidity Test	40°C, 95%RH, 1Vr, 500h	65°C, 90%RH, 1Vr, 500h	85°C, 85%RH, 1Vr, 1000h	85°C, 85%RH, 1.3~1.5Vr, 1000h
High Temp Load Test	Max. Temp, 1.0Vr, 1000h	Max. Temp, 1.5Vr, 1000h	Max. Temp, 1.5Vr, 1000h	Max. Temp, 2Vr, 1000h
Board Flex	1mm	1mm	2mm	2mm
Temp. Cycling	5cycle	5cycle	1000cycle	1000cycle

- \* 1. The part marked 'derating' is less than 150% of rated voltage in the durability and operational life test.
- \* 2. perform 2mm bending outgoing test.
- \* 3. Some of the parts are applicable in rated voltage × 150% or × 120%. Please refer to individual specifications.
- \* 4. Some of parts are 3mm bending guaranteed. Please refer to individual specifications.

# Normal Capacitors\_Standard

Normal Standard

## Features

- A Normal MLCC temporarily charges and reduces noise in electronic circuits, and is the most broadly available chip-type capacitor.
- The product line allows realization of various sizes and a wide range of capacitance.
- It also has the structural capacity to mount chips on a PCB at a high speed.

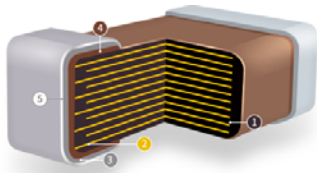

- ① Ceramic Body
- ② Electrode (Ni/Cu\*)
- ③ Plating (Ni)
- ④ Termination (Cu or Cu+Metal Epoxy)
- ⑤ Plating (Sn)

\* Internal Cu electrode is only applied to limited products.

### Wide Selection of Size & Wide Capacitance Range

Products offered with various sizes and a wide range of capacities

### Excellent DC Bias Characteristics

Capacitor with Excellent DC Bias Characteristics

### High Speed Automatic Chip Placement on PCBs

Chip Mountable on PCB at High Speed

## Application

- Smart Phone, PC, HDD/SSD Board, Tablet, Display, Game Machine, DC-DC Converter

## Structure and Dimensions

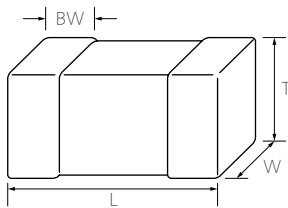

Size Code	Dimension (mm)				EIA (inch)
	L	W	T	BW	
02	0.40±0.02	0.20±0.02	0.20±0.02	0.1±0.03	01005
05025	0.50±0.025	0.25±0.025	0.25±0.025	0.13±0.04	015008
03	0.60±0.03	0.30±0.03	0.30±0.03	0.15±0.05	0201
	0.60±0.05	0.30±0.05	0.30±0.05		
	0.60±0.09	0.30±0.09	0.50±0.05		
	0.60±0.09	0.30±0.09	0.30±0.09		
05	1.00±0.05	0.50±0.05	0.50±0.05	0.25±0.10	0402
	1.00±0.05	0.50±0.05	0.30±0.03		
	1.00±0.05	0.50±0.05	0.20±0.02		
	1.00±0.07	0.50±0.07	0.50±0.07		
	1.00±0.10	0.50±0.10	0.50±0.10		
	1.00±0.10	0.50±0.10	0.30±0.03		
	1.00±0.15	0.50±0.15	0.50±0.15		
	1.00±0.15	0.50±0.15	0.30±0.03		
	1.00±0.20	0.50±0.20	0.50±0.20		
	1.00±0.20	0.50±0.25	0.70±0.10		
	1.00±0.20	0.50±0.20	0.60±0.20		
	1.00±0.20	0.50±0.20	0.50±0.05		
	1.15±0.05	0.70±0.05	0.70±0.05		

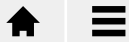

# Normal Capacitors\_Standard

Size Code	Dimension (mm)			BW	EIA (inch)
	L	W	T		
10	1.60±0.10	0.80±0.10	0.80±0.10	0.30±0.20	0603
	1.60±0.10	0.80±0.10	0.50+0.00/-0.10		
	1.60±0.15	0.80±0.15	0.80±0.15		
	1.60±0.20	0.80±0.20	0.80±0.20		
	1.60±0.20	0.80±0.20	0.80±0.20		
	1.60±0.20	0.80±0.20	0.70±0.20		
	1.60±0.25	0.80±0.25	0.70±0.10		
	1.60±0.25	0.80±0.25	0.80±0.25		
	1.60±0.30	0.80±0.30	0.70±0.10		
	1.60±0.30	0.80±0.30	0.80±0.30		
	1.60±0.30	0.80±0.30	0.50±0.30		
21	1.80±0.10	1.00±0.10	0.70±0.10	0.5+0.2/-0.3	0805
	2.00±0.10	1.25±0.10	0.65±0.10		
	2.00±0.10	1.25±0.10	0.85±0.10		
	2.00±0.10	1.25±0.10	0.90±0.10		
	2.00±0.10	1.25±0.10	1.25±0.10		
	2.00±0.15	1.25±0.15	0.85±0.10		
	2.00±0.15	1.25±0.15	1.25±0.15		
	2.00±0.20	1.25±0.20	0.70±0.10		
	2.00±0.20	1.25±0.20	0.80±0.10		
	2.00±0.20	1.25±0.20	0.85±0.10		
	2.00±0.20	1.25±0.20	0.90±0.10		
31	2.00±0.20	1.25±0.20	1.10±0.10	0.50±0.30	1206
	2.00±0.20	1.25±0.20	1.25±0.20		
	3.20±0.15	1.60±0.15	0.85±0.15		
	3.20±0.15	1.60±0.15	1.25±0.15		
	3.20±0.20	1.60±0.20	0.85±0.10		
	3.20±0.20	1.60±0.20	0.90±0.10		
32	3.20±0.20	1.60±0.20	1.15±0.10	0.60±0.30	1210
	3.20±0.20	1.60±0.20	1.15±0.15		
	3.20±0.20	1.60±0.20	1.60±0.20		
	3.20±0.30	2.50±0.20	0.85±0.10		
	3.20±0.30	2.50±0.20	1.25±0.20		
	3.20±0.30	2.50±0.20	1.35±0.15		
	3.20±0.30	2.50±0.20	1.40±0.20		
	3.20±0.30	2.50±0.20	1.60±0.10		
	3.20±0.30	2.50±0.20	1.60±0.20		
	3.20±0.30	2.50±0.20	1.80±0.20		
43	3.20±0.30	2.50±0.20	2.50±0.20	0.80±0.30	1812
	3.20±0.30	2.50±0.20	2.00±0.20		
	3.20±0.40	2.50±0.30	2.50±0.20		
	3.20±0.40	2.50±0.30	2.50±0.30		

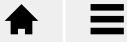

# Normal Capacitors\_Standard

## Capacitance Table (COG)

Category	TCC	Size Code (inch/mm)	Rated Voltage (Vdc)	Capacitance									Capacitance Range										
				pF			nF			uF													
				0.1	1	10	100	1	10	100	1	10		100									
Normal	COG (125°C)	008004/0201	16	█	█	█	█									0.2pF - 56pF							
			25	█	█	█	█										0.2pF - 56pF						
		01005/0402	6.3				█										100pF - 100pF						
			10				█										150pF - 150pF						
			16			█	█										8.2pF - 150pF						
			25		█	█	█										1pF - 220pF						
		0201/0603	50				█										100pF - 100pF						
			25	█	█	█	█										0.2pF - 100pF						
			100				█										100pF - 100pF						
		0402/1005	16					█	█								100pF - 1nF						
			25				█	█	█								20pF - 1nF						
			50		█	█	█	█									1pF - 4.7nF						
			100				█	█	█								12pF - 1nF						
		0603/1608	16							█							1nF - 2.2nF						
			25							█	█						560pF - 4.7nF						
			50			█	█	█	█								4.7pF - 5.6nF						
			100				█	█	█								10pF - 3.9nF						
			200						█								220pF - 220pF						
		0805/2012	250							█							470pF - 470pF						
			25								█	█					3.3nF - 10nF						
			50								█	█	█				10pF - 15nF						
			100								█	█	█				12pF - 3.9nF						
			200									█	█				18pF - 1nF						
		1206/3216	250									█	█				1nF - 10nF						
			16										█	█			15nF - 120nF						
			25										█	█			10nF - 100nF						
			50										█	█	█		10pF - 47nF						
			100										█	█	█		20pF - 22nF						
			200											█	█		220pF - 1nF						
			250												█	█	2.2nF - 22nF						
			500													█	█	10pF - 2.2nF					
			630														█	█	10pF - 10nF				
1000																█	█	10pF - 1nF					
1210/3225	2000															█	█	15pF - 100pF					
	25																█	█	10nF - 10nF				
	50																	█	█	1.8nF - 22nF			
	100																		█	█	33nF - 47nF		
	500																			█	█	680pF - 1.8nF	
	630																				█	█	1.8nF - 33nF
2000																					█	█	100pF - 100pF

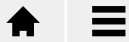

# Normal Capacitors\_Standard

## Capacitance Table (X5R)

Category	TCC	Size Code (inch/mm)	Rated Voltage (Vdc)	Capacitance									Capacitance Range				
				pF			nF			uF							
				0.1	1	10	100	1	10	100	1	10		100			
Normal	X5R (85°C)	008004/0201	6.3													1nF - 10nF	
			4														100nF - 1uF
		01005/0402	6.3														1nF - 1uF
			10														1nF - 10nF
		015008/0502	6.3														1uF - 1uF
			4														1uF - 4.9uF
		0201/0603	6.3														15nF - 4.7uF
			10														2.2nF - 2.2uF
			16														33nF - 2.2uF
			25														330pF - 330nF
			35														100nF - 220nF
		0302/0805	6.3														4.7uF - 4.7uF
			4														2.2uF - 27uF
		0402/1005	6.3														100nF - 22uF
			10														100nF - 10uF
			16														100nF - 4.7uF
			25														100nF - 4.7uF
			35														1uF - 2.2uF
			50														100nF - 100nF
		0603/1608	4														22uF - 47uF
			6.3														1uF - 47uF
			10														220nF - 22uF
			16														470nF - 22uF
			25														100nF - 10uF
			35														1uF - 10uF
		0805/2012	50														220nF - 2.2uF
			4														47uF - 100uF
			6.3														4.7uF - 47uF
			10														1uF - 47uF
			16														1uF - 22uF
			25														1uF - 22uF
		1206/3216	35														4.7uF - 4.7uF
			50														1uF - 10uF
			6.3														10uF - 100uF
			10														10uF - 47uF
			16														2.2uF - 22uF
			25														3.3uF - 22uF
			35														4.7uF - 4.7uF
		1210/3225	50														1uF - 10uF
			100														2.2uF - 2.2uF
6.3															22uF - 220uF		
10															10uF - 100uF		
16															10uF - 47uF		
25															2.2uF - 22uF		
	35														4.7uF - 10uF		
	50														10uF - 10uF		



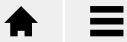

# Normal Capacitors\_Standard

## Capacitance Table (X7R)

Category	TCC	Size Code (inch/mm)	Rated Voltage (Vdc)	Capacitance											Capacitance Range			
				pF			nF			uF								
				0.1	1	10	100	1	10	100	1	10	100					
Normal	X7R (125°C)	01005/0402	10					■									100pF - 1nF	
			16				■										330pF - 330pF	
		0201/0603	6.3								■							2.2nF - 10nF
			10								■							1nF - 100nF
			16								■							150pF - 10nF
		0402/1005	25								■							120pF - 1.8nF
			6.3													■		100nF - 1uF
			10													■		22nF - 470nF
			16													■		820pF - 220nF
		0603/1608	25													■		560pF - 220nF
			50													■		150pF - 100nF
			100													■		220pF - 220pF
			6.3														■	470nF - 10uF
		0805/2012	10														■	220nF - 2.2uF
			16														■	10nF - 1uF
			25														■	4.7nF - 1uF
			50														■	100pF - 1uF
		1206/3216	100														■	1nF - 100nF
			6.3														■	10uF - 10uF
			10														■	680nF - 10uF
			16														■	100nF - 10uF
			25														■	1nF - 4.7uF
			50														■	100pF - 1uF
			100														■	220pF - 220nF
		1210/3225	200														■	220pF - 10nF
			250														■	1nF - 10nF
			6.3														■	10uF - 22uF
			10														■	1.2uF - 22uF
			16														■	330nF - 10uF
			25														■	220nF - 10uF
			35														■	10uF - 10uF
			50														■	220pF - 10uF
			100														■	2.2nF - 2.2uF
			200														■	470pF - 100nF
			250														■	33nF - 100nF
			350														■	33nF - 33nF
		X7R(S) (125°C)	500														■	220pF - 33nF
			630														■	330pF - 33nF
			1000														■	680pF - 2.2nF
			2000														■	1nF - 1nF
			6.3														■	47uF - 47uF
			10														■	10uF - 47uF
			16														■	10uF - 22uF
			25														■	1uF - 22uF
		35														■	10uF - 10uF	
		X7R(S) (125°C)	50														■	150nF - 10uF
			100														■	1uF - 2.2uF
			250														■	100nF - 100nF
			500														■	10nF - 10nF
			500														■	10uF - 10uF

\* X7R(S) = X7R (DC Bias 0.5Vr TCC)

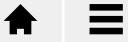

# Normal Capacitors\_Standard

## Capacitance Table (X7S)

Category	TCC	Size Code (inch/mm)	Rated Voltage (Vdc)	Capacitance									Capacitance Range										
				pF			nF			uF													
				0.1	1	10	100	1	10	100	1	10		100									
Normal	X7S (125°C)	0201/0603	10																			100nF - 100nF	
			16																				
		0603/1608	6.3																				10uF - 10uF
		0805/2012	25																				4.7uF - 4.7uF

## Capacitance Table (X7T)

Category	TCC	Size Code (inch/mm)	Rated Voltage (Vdc)	Capacitance									Capacitance Range											
				pF			nF			uF														
				0.1	1	10	100	1	10	100	1	10		100										
Normal	X7T (125°C)	0201/0603	6.3																				220nF - 220nF	
			4																					10uF - 10uF
		0805/2012	6.3																					22uF - 22uF
			25																					10uF - 10uF
			35																					10uF - 10uF
			50																					10uF - 10uF

## Capacitance Table (Y5V)

Category	TCC	Size Code (inch/mm)	Rated Voltage (Vdc)	Capacitance									Capacitance Range												
				pF			nF			uF															
				0.1	1	10	100	1	10	100	1	10		100											
Normal	Y5V (85°C)	0402/1005	6.3																				1uF - 1uF		
			10																					330nF - 470nF	
			16																						22nF - 100nF
			25																						22nF - 33nF
			50																						15nF - 15nF
		0603/1608	6.3																						2.2uF - 2.2uF
			10																						2.2uF - 2.2uF
			16																						100nF - 330nF
			25																						100nF - 470nF
			50																						10nF - 100nF
		0805/2012	6.3																						10uF - 10uF
			10																						2.2uF - 4.7uF
			16																						680nF - 2.2uF
			25																						100nF - 470nF
			50																						10nF - 1uF
		1206/3216	10																						10uF - 10uF
			16																						1uF - 4.7uF
			25																						1uF - 2.2uF
			50																						100nF - 1uF
			16																						10uF - 10uF
1210/3225	25																						10uF - 10uF		
	35																						10uF - 10uF		
	50																						1uF - 1uF		
	16																						10uF - 10uF		

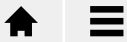

# Normal Capacitors\_Standard

## Capacitance Table (\*X7R(S))

Category	TCC	Size Code (inch/mm)	Rated Voltage (Vdc)	Capacitance												Capacitance Range
				pF				nF				uF				
				0.1	1	10	100	1	10	100	1	10	100			
Normal (Epoxy)	*X7R(S) (125°C)	0201/0603	25													10uF - 10uF

\* X7R(S) = X7R (DC Bias 0.5Vr TCC)

## Capacitance Table (X7S)

Category	TCC	Size Code (inch/mm)	Rated Voltage (Vdc)	Capacitance												Capacitance Range
				pF				nF				uF				
				0.1	1	10	100	1	10	100	1	10	100			
Normal (Epoxy)	X7S (125°C)	1206/3216	100													4.7uF - 4.7uF

## Product Lineup (COG)

Size Code (inch/mm) : 008004/0201

No.	Thickness Max. (mm)	Rated Voltage (Vdc)	TCC	Capacitance	Capacitance Tolerance	Part Number
1	0.138	16	COG	0.2pF	±0.1pF	CLR1C0R2B01INN#
2	0.138	16	COG	0.3pF	±0.1pF	CLR1C0R3B01INN#
3	0.138	16	COG	0.4pF	±0.1pF	CLR1C0R4B01INN#
4	0.138	16	COG	0.5pF	±0.1pF	CLR1C0R5B01INN#
5	0.138	16	COG	0.6pF	±0.1pF	CLR1C0R6B01INN#
6	0.138	16	COG	0.7pF	±0.1pF	CLR1C0R7B01INN#
7	0.138	16	COG	0.8pF	±0.1pF	CLR1C0R8B01INN#
8	0.138	16	COG	0.9pF	±0.1pF	CLR1C0R9B01INN#
9	0.138	16	COG	1pF	±0.1pF	CLR1C010B01INN#
10	0.138	16	COG	1pF	±0.25pF	CLR1C010C01INN#
11	0.138	16	COG	1.1pF	±0.1pF	CLR1C1R1B01INN#
12	0.138	16	COG	1.1pF	±0.25pF	CLR1C1R1C01INN#
13	0.138	16	COG	1.2pF	±0.1pF	CLR1C1R2B01INN#
14	0.138	16	COG	1.2pF	±0.25pF	CLR1C1R2C01INN#
15	0.138	16	COG	1.3pF	±0.1pF	CLR1C1R3B01INN#
16	0.138	16	COG	1.3pF	±0.25pF	CLR1C1R3C01INN#
17	0.138	16	COG	1.4pF	±0.1pF	CLR1C1R4B01INN#
18	0.138	16	COG	1.4pF	±0.25pF	CLR1C1R4C01INN#
19	0.138	16	COG	1.5pF	±0.1pF	CLR1C1R5B01INN#
20	0.138	16	COG	1.5pF	±0.25pF	CLR1C1R5C01INN#
21	0.138	16	COG	1.6pF	±0.1pF	CLR1C1R6B01INN#
22	0.138	16	COG	1.6pF	±0.25pF	CLR1C1R6C01INN#
23	0.138	16	COG	1.7pF	±0.1pF	CLR1C1R7B01INN#
24	0.138	16	COG	1.7pF	±0.25pF	CLR1C1R7C01INN#
25	0.138	16	COG	1.8pF	±0.1pF	CLR1C1R8B01INN#



# Normal Capacitors\_Standard

Size Code (inch/mm) : 008004/0201

No.	Thickness Max. (mm)	Rated Voltage (Vdc)	TCC	Capacitance	Capacitance Tolerance	Part Number
26	0.138	16	COG	1.8pF	±0.25pF	CLR1C1R8CO1INN#
27	0.138	16	COG	1.9pF	±0.1pF	CLR1C1R9BO1INN#
28	0.138	16	COG	1.9pF	±0.25pF	CLR1C1R9CO1INN#
29	0.138	16	COG	2pF	±0.1pF	CLR1C020BO1INN#
30	0.138	16	COG	2pF	±0.25pF	CLR1C020CO1INN#
31	0.138	16	COG	2.1pF	±0.1pF	CLR1C2R1BO1INN#
32	0.138	16	COG	2.1pF	±0.25pF	CLR1C2R1CO1INN#
33	0.138	16	COG	2.2pF	±0.1pF	CLR1C2R2BO1INN#
34	0.138	16	COG	2.2pF	±0.25pF	CLR1C2R2CO1INN#
35	0.138	16	COG	2.3pF	±0.1pF	CLR1C2R3BO1INN#
36	0.138	16	COG	2.3pF	±0.25pF	CLR1C2R3CO1INN#
37	0.138	16	COG	2.4pF	±0.1pF	CLR1C2R4BO1INN#
38	0.138	16	COG	2.4pF	±0.25pF	CLR1C2R4CO1INN#
39	0.138	16	COG	2.5pF	±0.1pF	CLR1C2R5BO1INN#
40	0.138	16	COG	2.5pF	±0.25pF	CLR1C2R5CO1INN#
41	0.138	16	COG	2.6pF	±0.1pF	CLR1C2R6BO1INN#
42	0.138	16	COG	2.6pF	±0.25pF	CLR1C2R6CO1INN#
43	0.138	16	COG	2.7pF	±0.1pF	CLR1C2R7BO1INN#
44	0.138	16	COG	2.7pF	±0.25pF	CLR1C2R7CO1INN#
45	0.138	16	COG	2.8pF	±0.1pF	CLR1C2R8BO1INN#
46	0.138	16	COG	2.8pF	±0.25pF	CLR1C2R8CO1INN#
47	0.138	16	COG	2.9pF	±0.1pF	CLR1C2R9BO1INN#
48	0.138	16	COG	2.9pF	±0.25pF	CLR1C2R9CO1INN#
49	0.138	16	COG	3pF	±0.1pF	CLR1C030BO1INN#
50	0.138	16	COG	3pF	±0.25pF	CLR1C030CO1INN#
51	0.138	16	COG	3.1pF	±0.1pF	CLR1C3R1BO1INN#
52	0.138	16	COG	3.1pF	±0.25pF	CLR1C3R1CO1INN#
53	0.138	16	COG	3.2pF	±0.1pF	CLR1C3R2BO1INN#
54	0.138	16	COG	3.2pF	±0.25pF	CLR1C3R2CO1INN#
55	0.138	16	COG	3.3pF	±0.1pF	CLR1C3R3BO1INN#
56	0.138	16	COG	3.3pF	±0.25pF	CLR1C3R3CO1INN#
57	0.138	16	COG	3.4pF	±0.1pF	CLR1C3R4BO1INN#
58	0.138	16	COG	3.4pF	±0.25pF	CLR1C3R4CO1INN#
59	0.138	16	COG	3.5pF	±0.1pF	CLR1C3R5BO1INN#
60	0.138	16	COG	3.5pF	±0.25pF	CLR1C3R5CO1INN#
61	0.138	16	COG	3.6pF	±0.1pF	CLR1C3R6BO1INN#
62	0.138	16	COG	3.6pF	±0.25pF	CLR1C3R6CO1INN#
63	0.138	16	COG	3.7pF	±0.1pF	CLR1C3R7BO1INN#
64	0.138	16	COG	3.7pF	±0.25pF	CLR1C3R7CO1INN#
65	0.138	16	COG	3.8pF	±0.1pF	CLR1C3R8BO1INN#
66	0.138	16	COG	3.8pF	±0.25pF	CLR1C3R8CO1INN#
67	0.138	16	COG	3.9pF	±0.1pF	CLR1C3R9BO1INN#
68	0.138	16	COG	3.9pF	±0.25pF	CLR1C3R9CO1INN#
69	0.138	16	COG	4pF	±0.1pF	CLR1C040BO1INN#
70	0.138	16	COG	4pF	±0.25pF	CLR1C040CO1INN#



# Normal Capacitors\_Standard

Size Code (inch/mm) : 008004/0201

No.	Thickness Max. (mm)	Rated Voltage (Vdc)	TCC	Capacitance	Capacitance Tolerance	Part Number
71	0.138	16	COG	4.1pF	±0.1pF	CLR1C4R1B01INN#
72	0.138	16	COG	4.1pF	±0.25pF	CLR1C4R1C01INN#
73	0.138	16	COG	4.2pF	±0.1pF	CLR1C4R2B01INN#
74	0.138	16	COG	4.2pF	±0.25pF	CLR1C4R2C01INN#
75	0.138	16	COG	4.3pF	±0.1pF	CLR1C4R3B01INN#
76	0.138	16	COG	4.3pF	±0.25pF	CLR1C4R3C01INN#
77	0.138	16	COG	4.4pF	±0.1pF	CLR1C4R4B01INN#
78	0.138	16	COG	4.4pF	±0.25pF	CLR1C4R4C01INN#
79	0.138	16	COG	4.5pF	±0.1pF	CLR1C4R5B01INN#
80	0.138	16	COG	4.5pF	±0.25pF	CLR1C4R5C01INN#
81	0.138	16	COG	4.6pF	±0.1pF	CLR1C4R6B01INN#
82	0.138	16	COG	4.6pF	±0.25pF	CLR1C4R6C01INN#
83	0.138	16	COG	4.7pF	±0.1pF	CLR1C4R7B01INN#
84	0.138	16	COG	4.7pF	±0.25pF	CLR1C4R7C01INN#
85	0.138	16	COG	4.8pF	±0.1pF	CLR1C4R8B01INN#
86	0.138	16	COG	4.8pF	±0.25pF	CLR1C4R8C01INN#
87	0.138	16	COG	4.9pF	±0.1pF	CLR1C4R9B01INN#
88	0.138	16	COG	4.9pF	±0.25pF	CLR1C4R9C01INN#
89	0.138	16	COG	5pF	±0.1pF	CLR1C050B01INN#
90	0.138	16	COG	5pF	±0.25pF	CLR1C050C01INN#
91	0.138	16	COG	5.1pF	±0.1pF	CLR1C5R1B01INN#
92	0.138	16	COG	5.1pF	±0.25pF	CLR1C5R1C01INN#
93	0.138	16	COG	5.1pF	±0.5pF	CLR1C5R1D01INN#
94	0.138	16	COG	5.2pF	±0.1pF	CLR1C5R2B01INN#
95	0.138	16	COG	5.2pF	±0.25pF	CLR1C5R2C01INN#
96	0.138	16	COG	5.2pF	±0.5pF	CLR1C5R2D01INN#
97	0.138	16	COG	5.3pF	±0.1pF	CLR1C5R3B01INN#
98	0.138	16	COG	5.3pF	±0.25pF	CLR1C5R3C01INN#
99	0.138	16	COG	5.3pF	±0.5pF	CLR1C5R3D01INN#
100	0.138	16	COG	5.4pF	±0.1pF	CLR1C5R4B01INN#
101	0.138	16	COG	5.4pF	±0.25pF	CLR1C5R4C01INN#
102	0.138	16	COG	5.4pF	±0.5pF	CLR1C5R4D01INN#
103	0.138	16	COG	5.5pF	±0.1pF	CLR1C5R5B01INN#
104	0.138	16	COG	5.5pF	±0.25pF	CLR1C5R5C01INN#
105	0.138	16	COG	5.5pF	±0.5pF	CLR1C5R5D01INN#
106	0.138	16	COG	5.6pF	±0.1pF	CLR1C5R6B01INN#
107	0.138	16	COG	5.6pF	±0.25pF	CLR1C5R6C01INN#
108	0.138	16	COG	5.6pF	±0.5pF	CLR1C5R6D01INN#
109	0.138	16	COG	5.7pF	±0.1pF	CLR1C5R7B01INN#
110	0.138	16	COG	5.7pF	±0.25pF	CLR1C5R7C01INN#
111	0.138	16	COG	5.7pF	±0.5pF	CLR1C5R7D01INN#
112	0.138	16	COG	5.8pF	±0.1pF	CLR1C5R8B01INN#
113	0.138	16	COG	5.8pF	±0.25pF	CLR1C5R8C01INN#
114	0.138	16	COG	5.8pF	±0.5pF	CLR1C5R8D01INN#
115	0.138	16	COG	5.9pF	±0.1pF	CLR1C5R9B01INN#



# Normal Capacitors\_Standard

Size Code (inch/mm) : 008004/0201

No.	Thickness Max. (mm)	Rated Voltage (Vdc)	TCC	Capacitance	Capacitance Tolerance	Part Number
116	0.138	16	COG	5.9pF	±0.25pF	CLR1C5R9C01INN#
117	0.138	16	COG	5.9pF	±0.5pF	CLR1C5R9D01INN#
118	0.138	16	COG	6pF	±0.1pF	CLR1C060B01INN#
119	0.138	16	COG	6pF	±0.25pF	CLR1C060C01INN#
120	0.138	16	COG	6pF	±0.5pF	CLR1C060D01INN#
121	0.138	16	COG	6.1pF	±0.1pF	CLR1C6R1B01INN#
122	0.138	16	COG	6.1pF	±0.25pF	CLR1C6R1C01INN#
123	0.138	16	COG	6.1pF	±0.5pF	CLR1C6R1D01INN#
124	0.138	16	COG	6.2pF	±0.1pF	CLR1C6R2B01INN#
125	0.138	16	COG	6.2pF	±0.25pF	CLR1C6R2C01INN#
126	0.138	16	COG	6.2pF	±0.5pF	CLR1C6R2D01INN#
127	0.138	16	COG	6.3pF	±0.1pF	CLR1C6R3B01INN#
128	0.138	16	COG	6.3pF	±0.25pF	CLR1C6R3C01INN#
129	0.138	16	COG	6.3pF	±0.5pF	CLR1C6R3D01INN#
130	0.138	16	COG	6.4pF	±0.1pF	CLR1C6R4B01INN#
131	0.138	16	COG	6.4pF	±0.25pF	CLR1C6R4C01INN#
132	0.138	16	COG	6.4pF	±0.5pF	CLR1C6R4D01INN#
133	0.138	16	COG	6.5pF	±0.1pF	CLR1C6R5B01INN#
134	0.138	16	COG	6.5pF	±0.25pF	CLR1C6R5C01INN#
135	0.138	16	COG	6.5pF	±0.5pF	CLR1C6R5D01INN#
136	0.138	16	COG	6.6pF	±0.1pF	CLR1C6R6B01INN#
137	0.138	16	COG	6.6pF	±0.25pF	CLR1C6R6C01INN#
138	0.138	16	COG	6.6pF	±0.5pF	CLR1C6R6D01INN#
139	0.138	16	COG	6.7pF	±0.1pF	CLR1C6R7B01INN#
140	0.138	16	COG	6.7pF	±0.25pF	CLR1C6R7C01INN#
141	0.138	16	COG	6.7pF	±0.5pF	CLR1C6R7D01INN#
142	0.138	16	COG	6.8pF	±0.1pF	CLR1C6R8B01INN#
143	0.138	16	COG	6.8pF	±0.25pF	CLR1C6R8C01INN#
144	0.138	16	COG	6.8pF	±0.5pF	CLR1C6R8D01INN#
145	0.138	16	COG	6.9pF	±0.1pF	CLR1C6R9B01INN#
146	0.138	16	COG	6.9pF	±0.25pF	CLR1C6R9C01INN#
147	0.138	16	COG	6.9pF	±0.5pF	CLR1C6R9D01INN#
148	0.138	16	COG	7pF	±0.1pF	CLR1C070B01INN#
149	0.138	16	COG	7pF	±0.25pF	CLR1C070C01INN#
150	0.138	16	COG	7pF	±0.5pF	CLR1C070D01INN#
151	0.138	16	COG	7.1pF	±0.1pF	CLR1C7R1B01INN#
152	0.138	16	COG	7.1pF	±0.25pF	CLR1C7R1C01INN#
153	0.138	16	COG	7.1pF	±0.5pF	CLR1C7R1D01INN#
154	0.138	16	COG	7.2pF	±0.1pF	CLR1C7R2B01INN#
155	0.138	16	COG	7.2pF	±0.25pF	CLR1C7R2C01INN#
156	0.138	16	COG	7.2pF	±0.5pF	CLR1C7R2D01INN#
157	0.138	16	COG	7.3pF	±0.1pF	CLR1C7R3B01INN#
158	0.138	16	COG	7.3pF	±0.25pF	CLR1C7R3C01INN#
159	0.138	16	COG	7.3pF	±0.5pF	CLR1C7R3D01INN#
160	0.138	16	COG	7.4pF	±0.1pF	CLR1C7R4B01INN#



# Normal Capacitors\_Standard

Size Code (inch/mm) : 008004/0201

No.	Thickness Max. (mm)	Rated Voltage (Vdc)	TCC	Capacitance	Capacitance Tolerance	Part Number
161	0.138	16	COG	7.4pF	±0.25pF	CLR1C7R4C01INN#
162	0.138	16	COG	7.4pF	±0.5pF	CLR1C7R4D01INN#
163	0.138	16	COG	7.5pF	±0.1pF	CLR1C7R5B01INN#
164	0.138	16	COG	7.5pF	±0.25pF	CLR1C7R5C01INN#
165	0.138	16	COG	7.5pF	±0.5pF	CLR1C7R5D01INN#
166	0.138	16	COG	7.6pF	±0.1pF	CLR1C7R6B01INN#
167	0.138	16	COG	7.6pF	±0.25pF	CLR1C7R6C01INN#
168	0.138	16	COG	7.6pF	±0.5pF	CLR1C7R6D01INN#
169	0.138	16	COG	7.7pF	±0.1pF	CLR1C7R7B01INN#
170	0.138	16	COG	7.7pF	±0.25pF	CLR1C7R7C01INN#
171	0.138	16	COG	7.7pF	±0.5pF	CLR1C7R7D01INN#
172	0.138	16	COG	7.8pF	±0.1pF	CLR1C7R8B01INN#
173	0.138	16	COG	7.8pF	±0.25pF	CLR1C7R8C01INN#
174	0.138	16	COG	7.8pF	±0.5pF	CLR1C7R8D01INN#
175	0.138	16	COG	7.9pF	±0.1pF	CLR1C7R9B01INN#
176	0.138	16	COG	7.9pF	±0.25pF	CLR1C7R9C01INN#
177	0.138	16	COG	7.9pF	±0.5pF	CLR1C7R9D01INN#
178	0.138	16	COG	8pF	±0.1pF	CLR1C080B01INN#
179	0.138	16	COG	8pF	±0.25pF	CLR1C080C01INN#
180	0.138	16	COG	8pF	±0.5pF	CLR1C080D01INN#
181	0.138	16	COG	8.1pF	±0.1pF	CLR1C8R1B01INN#
182	0.138	16	COG	8.1pF	±0.25pF	CLR1C8R1C01INN#
183	0.138	16	COG	8.1pF	±0.5pF	CLR1C8R1D01INN#
184	0.138	16	COG	8.2pF	±0.1pF	CLR1C8R2B01INN#
185	0.138	16	COG	8.2pF	±0.25pF	CLR1C8R2C01INN#
186	0.138	16	COG	8.2pF	±0.5pF	CLR1C8R2D01INN#
187	0.138	16	COG	8.3pF	±0.1pF	CLR1C8R3B01INN#
188	0.138	16	COG	8.3pF	±0.25pF	CLR1C8R3C01INN#
189	0.138	16	COG	8.3pF	±0.5pF	CLR1C8R3D01INN#
190	0.138	16	COG	8.4pF	±0.1pF	CLR1C8R4B01INN#
191	0.138	16	COG	8.4pF	±0.25pF	CLR1C8R4C01INN#
192	0.138	16	COG	8.4pF	±0.5pF	CLR1C8R4D01INN#
193	0.138	16	COG	8.5pF	±0.1pF	CLR1C8R5B01INN#
194	0.138	16	COG	8.5pF	±0.25pF	CLR1C8R5C01INN#
195	0.138	16	COG	8.5pF	±0.5pF	CLR1C8R5D01INN#
196	0.138	16	COG	8.6pF	±0.1pF	CLR1C8R6B01INN#
197	0.138	16	COG	8.6pF	±0.25pF	CLR1C8R6C01INN#
198	0.138	16	COG	8.6pF	±0.5pF	CLR1C8R6D01INN#
199	0.138	16	COG	8.7pF	±0.1pF	CLR1C8R7B01INN#
200	0.138	16	COG	8.7pF	±0.25pF	CLR1C8R7C01INN#
201	0.138	16	COG	8.7pF	±0.5pF	CLR1C8R7D01INN#
202	0.138	16	COG	8.8pF	±0.1pF	CLR1C8R8B01INN#
203	0.138	16	COG	8.8pF	±0.25pF	CLR1C8R8C01INN#
204	0.138	16	COG	8.8pF	±0.5pF	CLR1C8R8D01INN#
205	0.138	16	COG	8.9pF	±0.1pF	CLR1C8R9B01INN#



# Normal Capacitors\_Standard

Size Code (inch/mm) : 008004/0201

No.	Thickness Max. (mm)	Rated Voltage (Vdc)	TCC	Capacitance	Capacitance Tolerance	Part Number
206	0.138	16	COG	8.9pF	±0.25pF	CLR1C8R9C01INN#
207	0.138	16	COG	8.9pF	±0.5pF	CLR1C8R9D01INN#
208	0.138	16	COG	9pF	±0.1pF	CLR1C090B01INN#
209	0.138	16	COG	9pF	±0.25pF	CLR1C090C01INN#
210	0.138	16	COG	9pF	±0.5pF	CLR1C090D01INN#
211	0.138	16	COG	9.1pF	±0.1pF	CLR1C9R1B01INN#
212	0.138	16	COG	9.1pF	±0.25pF	CLR1C9R1C01INN#
213	0.138	16	COG	9.1pF	±0.5pF	CLR1C9R1D01INN#
214	0.138	16	COG	9.2pF	±0.1pF	CLR1C9R2B01INN#
215	0.138	16	COG	9.2pF	±0.25pF	CLR1C9R2C01INN#
216	0.138	16	COG	9.2pF	±0.5pF	CLR1C9R2D01INN#
217	0.138	16	COG	9.3pF	±0.1pF	CLR1C9R3B01INN#
218	0.138	16	COG	9.3pF	±0.25pF	CLR1C9R3C01INN#
219	0.138	16	COG	9.3pF	±0.5pF	CLR1C9R3D01INN#
220	0.138	16	COG	9.4pF	±0.1pF	CLR1C9R4B01INN#
221	0.138	16	COG	9.4pF	±0.25pF	CLR1C9R4C01INN#
222	0.138	16	COG	9.4pF	±0.5pF	CLR1C9R4D01INN#
223	0.138	16	COG	9.5pF	±0.1pF	CLR1C9R5B01INN#
224	0.138	16	COG	9.5pF	±0.25pF	CLR1C9R5C01INN#
225	0.138	16	COG	9.5pF	±0.5pF	CLR1C9R5D01INN#
226	0.138	16	COG	9.6pF	±0.1pF	CLR1C9R6B01INN#
227	0.138	16	COG	9.6pF	±0.25pF	CLR1C9R6C01INN#
228	0.138	16	COG	9.6pF	±0.5pF	CLR1C9R6D01INN#
229	0.138	16	COG	9.7pF	±0.1pF	CLR1C9R7B01INN#
230	0.138	16	COG	9.7pF	±0.25pF	CLR1C9R7C01INN#
231	0.138	16	COG	9.7pF	±0.5pF	CLR1C9R7D01INN#
232	0.138	16	COG	9.8pF	±0.1pF	CLR1C9R8B01INN#
233	0.138	16	COG	9.8pF	±0.25pF	CLR1C9R8C01INN#
234	0.138	16	COG	9.8pF	±0.5pF	CLR1C9R8D01INN#
235	0.138	16	COG	9.9pF	±0.1pF	CLR1C9R9B01INN#
236	0.138	16	COG	9.9pF	±0.25pF	CLR1C9R9C01INN#
237	0.138	16	COG	9.9pF	±0.5pF	CLR1C9R9D01INN#
238	0.138	16	COG	10pF	±0.05pF	CLR1C100A01INN#
239	0.138	16	COG	10pF	±0.1pF	CLR1C100B01INN#
240	0.138	16	COG	10pF	±0.25pF	CLR1C100C01INN#
241	0.138	16	COG	10pF	±0.5pF	CLR1C100D01INN#
242	0.138	16	COG	10pF	±5%	CLR1C100J01INN#
243	0.138	16	COG	12pF	±5%	CLR1C120J01INN#
244	0.138	16	COG	15pF	±5%	CLR1C150J01INN#
245	0.138	16	COG	18pF	±5%	CLR1C180J01INN#
246	0.138	16	COG	22pF	±5%	CLR1C220J01INN#
247	0.138	16	COG	27pF	±5%	CLR1C270J01INN#
248	0.138	16	COG	33pF	±5%	CLR1C330J01INN#
249	0.138	16	COG	36pF	±5%	CLR1C360J01INN#
250	0.138	16	COG	39pF	±5%	CLR1C390J01INN#

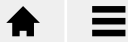

# Normal Capacitors\_Standard

Size Code (inch/mm) : 008004/0201

No.	Thickness Max. (mm)	Rated Voltage (Vdc)	TCC	Capacitance	Capacitance Tolerance	Part Number
251	0.138	16	COG	47pF	±5%	CLR1C470J01NINN#
252	0.138	16	COG	56pF	±5%	CLR1C560J01NINN#
253	0.138	25	COG	0.2pF	±0.05pF	CLR1C0R2AA1INN#
254	0.138	25	COG	0.2pF	±0.1pF	CLR1C0R2BA1INN#
255	0.138	25	COG	0.2pF	±0.1pF	CLR1C0R2BA1NINN#
256	0.138	25	COG	0.3pF	±0.05pF	CLR1C0R3AA1INN#
257	0.138	25	COG	0.3pF	±0.1pF	CLR1C0R3BA1INN#
258	0.138	25	COG	0.3pF	±0.1pF	CLR1C0R3BA1NINN#
259	0.138	25	COG	0.4pF	±0.05pF	CLR1C0R4AA1INN#
260	0.138	25	COG	0.4pF	±0.1pF	CLR1C0R4BA1INN#
261	0.138	25	COG	0.4pF	±0.1pF	CLR1C0R4BA1NINN#
262	0.138	25	COG	0.5pF	±0.05pF	CLR1C0R5AA1INN#
263	0.138	25	COG	0.5pF	±0.1pF	CLR1C0R5BA1INN#
264	0.138	25	COG	0.5pF	±0.1pF	CLR1C0R5BA1NINN#
265	0.138	25	COG	0.6pF	±0.05pF	CLR1C0R6AA1INN#
266	0.138	25	COG	0.6pF	±0.1pF	CLR1C0R6BA1INN#
267	0.138	25	COG	0.6pF	±0.1pF	CLR1C0R6BA1NINN#
268	0.138	25	COG	0.7pF	±0.05pF	CLR1C0R7AA1INN#
269	0.138	25	COG	0.7pF	±0.1pF	CLR1C0R7BA1INN#
270	0.138	25	COG	0.7pF	±0.1pF	CLR1C0R7BA1NINN#
271	0.138	25	COG	0.8pF	±0.05pF	CLR1C0R8AA1INN#
272	0.138	25	COG	0.8pF	±0.1pF	CLR1C0R8BA1INN#
273	0.138	25	COG	0.8pF	±0.1pF	CLR1C0R8BA1NINN#
274	0.138	25	COG	0.9pF	±0.05pF	CLR1C0R9AA1INN#
275	0.138	25	COG	0.9pF	±0.1pF	CLR1C0R9BA1INN#
276	0.138	25	COG	1pF	±0.05pF	CLR1C010AA1INN#
277	0.138	25	COG	1pF	±0.1pF	CLR1C010BA1INN#
278	0.138	25	COG	1pF	±0.25pF	CLR1C010CA1INN#
279	0.138	25	COG	1.1pF	±0.05pF	CLR1C1R1AA1INN#
280	0.138	25	COG	1.1pF	±0.1pF	CLR1C1R1BA1INN#
281	0.138	25	COG	1.1pF	±0.25pF	CLR1C1R1CA1INN#
282	0.138	25	COG	1.2pF	±0.05pF	CLR1C1R2AA1INN#
283	0.138	25	COG	1.2pF	±0.1pF	CLR1C1R2BA1INN#
284	0.138	25	COG	1.2pF	±0.25pF	CLR1C1R2CA1INN#
285	0.138	25	COG	1.3pF	±0.05pF	CLR1C1R3AA1INN#
286	0.138	25	COG	1.3pF	±0.1pF	CLR1C1R3BA1INN#
287	0.138	25	COG	1.3pF	±0.25pF	CLR1C1R3CA1INN#
288	0.138	25	COG	1.4pF	±0.05pF	CLR1C1R4AA1INN#
289	0.138	25	COG	1.4pF	±0.1pF	CLR1C1R4BA1INN#
290	0.138	25	COG	1.4pF	±0.25pF	CLR1C1R4CA1INN#
291	0.138	25	COG	1.5pF	±0.05pF	CLR1C1R5AA1INN#
292	0.138	25	COG	1.5pF	±0.1pF	CLR1C1R5BA1INN#
293	0.138	25	COG	1.5pF	±0.25pF	CLR1C1R5CA1INN#
294	0.138	25	COG	1.6pF	±0.05pF	CLR1C1R6AA1INN#
295	0.138	25	COG	1.6pF	±0.1pF	CLR1C1R6BA1INN#

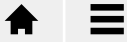

# Normal Capacitors\_Standard

Size Code (inch/mm) : 008004/0201

No.	Thickness Max. (mm)	Rated Voltage (Vdc)	TCC	Capacitance	Capacitance Tolerance	Part Number
296	0.138	25	COG	1.6pF	±0.25pF	CLR1C1R6CA1INN#
297	0.138	25	COG	1.7pF	±0.05pF	CLR1C1R7AA1INN#
298	0.138	25	COG	1.7pF	±0.1pF	CLR1C1R7BA1INN#
299	0.138	25	COG	1.7pF	±0.25pF	CLR1C1R7CA1INN#
300	0.138	25	COG	1.8pF	±0.05pF	CLR1C1R8AA1INN#
301	0.138	25	COG	1.8pF	±0.1pF	CLR1C1R8BA1INN#
302	0.138	25	COG	1.8pF	±0.25pF	CLR1C1R8CA1INN#
303	0.138	25	COG	1.9pF	±0.05pF	CLR1C1R9AA1INN#
304	0.138	25	COG	1.9pF	±0.1pF	CLR1C1R9BA1INN#
305	0.138	25	COG	1.9pF	±0.25pF	CLR1C1R9CA1INN#
306	0.138	25	COG	2pF	±0.05pF	CLR1C020AA1INN#
307	0.138	25	COG	2pF	±0.1pF	CLR1C020BA1INN#
308	0.138	25	COG	2pF	±0.25pF	CLR1C020CA1INN#
309	0.138	25	COG	2.1pF	±0.05pF	CLR1C2R1AA1INN#
310	0.138	25	COG	2.1pF	±0.1pF	CLR1C2R1BA1INN#
311	0.138	25	COG	2.1pF	±0.25pF	CLR1C2R1CA1INN#
312	0.138	25	COG	2.2pF	±0.05pF	CLR1C2R2AA1INN#
313	0.138	25	COG	2.2pF	±0.1pF	CLR1C2R2BA1INN#
314	0.138	25	COG	2.2pF	±0.25pF	CLR1C2R2CA1INN#
315	0.138	25	COG	2.3pF	±0.05pF	CLR1C2R3AA1INN#
316	0.138	25	COG	2.3pF	±0.1pF	CLR1C2R3BA1INN#
317	0.138	25	COG	2.3pF	±0.25pF	CLR1C2R3CA1INN#
318	0.138	25	COG	2.4pF	±0.05pF	CLR1C2R4AA1INN#
319	0.138	25	COG	2.4pF	±0.1pF	CLR1C2R4BA1INN#
320	0.138	25	COG	2.4pF	±0.25pF	CLR1C2R4CA1INN#
321	0.138	25	COG	2.5pF	±0.05pF	CLR1C2R5AA1INN#
322	0.138	25	COG	2.5pF	±0.1pF	CLR1C2R5BA1INN#
323	0.138	25	COG	2.5pF	±0.25pF	CLR1C2R5CA1INN#
324	0.138	25	COG	2.6pF	±0.05pF	CLR1C2R6AA1INN#
325	0.138	25	COG	2.6pF	±0.1pF	CLR1C2R6BA1INN#
326	0.138	25	COG	2.6pF	±0.25pF	CLR1C2R6CA1INN#
327	0.138	25	COG	2.7pF	±0.05pF	CLR1C2R7AA1INN#
328	0.138	25	COG	2.7pF	±0.1pF	CLR1C2R7BA1INN#
329	0.138	25	COG	2.7pF	±0.25pF	CLR1C2R7CA1INN#
330	0.138	25	COG	2.8pF	±0.05pF	CLR1C2R8AA1INN#
331	0.138	25	COG	2.8pF	±0.1pF	CLR1C2R8BA1INN#
332	0.138	25	COG	2.8pF	±0.25pF	CLR1C2R8CA1INN#
333	0.138	25	COG	2.9pF	±0.05pF	CLR1C2R9AA1INN#
334	0.138	25	COG	2.9pF	±0.1pF	CLR1C2R9BA1INN#
335	0.138	25	COG	2.9pF	±0.25pF	CLR1C2R9CA1INN#
336	0.138	25	COG	3pF	±0.05pF	CLR1C030AA1INN#
337	0.138	25	COG	3pF	±0.1pF	CLR1C030BA1INN#
338	0.138	25	COG	3pF	±0.25pF	CLR1C030CA1INN#
339	0.138	25	COG	3.1pF	±0.05pF	CLR1C3R1AA1INN#
340	0.138	25	COG	3.1pF	±0.1pF	CLR1C3R1BA1INN#



# Normal Capacitors\_Standard

Size Code (inch/mm) : 008004/0201

No.	Thickness Max. (mm)	Rated Voltage (Vdc)	TCC	Capacitance	Capacitance Tolerance	Part Number
341	0.138	25	COG	3.1pF	±0.25pF	CLR1C3R1CA1INN#
342	0.138	25	COG	3.2pF	±0.05pF	CLR1C3R2AA1INN#
343	0.138	25	COG	3.2pF	±0.1pF	CLR1C3R2BA1INN#
344	0.138	25	COG	3.2pF	±0.25pF	CLR1C3R2CA1INN#
345	0.138	25	COG	3.3pF	±0.05pF	CLR1C3R3AA1INN#
346	0.138	25	COG	3.3pF	±0.1pF	CLR1C3R3BA1INN#
347	0.138	25	COG	3.3pF	±0.25pF	CLR1C3R3CA1INN#
348	0.138	25	COG	3.4pF	±0.05pF	CLR1C3R4AA1INN#
349	0.138	25	COG	3.4pF	±0.1pF	CLR1C3R4BA1INN#
350	0.138	25	COG	3.4pF	±0.25pF	CLR1C3R4CA1INN#
351	0.138	25	COG	3.5pF	±0.05pF	CLR1C3R5AA1INN#
352	0.138	25	COG	3.5pF	±0.1pF	CLR1C3R5BA1INN#
353	0.138	25	COG	3.5pF	±0.25pF	CLR1C3R5CA1INN#
354	0.138	25	COG	3.6pF	±0.05pF	CLR1C3R6AA1INN#
355	0.138	25	COG	3.6pF	±0.1pF	CLR1C3R6BA1INN#
356	0.138	25	COG	3.6pF	±0.25pF	CLR1C3R6CA1INN#
357	0.138	25	COG	3.7pF	±0.05pF	CLR1C3R7AA1INN#
358	0.138	25	COG	3.7pF	±0.1pF	CLR1C3R7BA1INN#
359	0.138	25	COG	3.7pF	±0.25pF	CLR1C3R7CA1INN#
360	0.138	25	COG	3.8pF	±0.05pF	CLR1C3R8AA1INN#
361	0.138	25	COG	3.8pF	±0.1pF	CLR1C3R8BA1INN#
362	0.138	25	COG	3.8pF	±0.25pF	CLR1C3R8CA1INN#
363	0.138	25	COG	3.9pF	±0.05pF	CLR1C3R9AA1INN#
364	0.138	25	COG	3.9pF	±0.1pF	CLR1C3R9BA1INN#
365	0.138	25	COG	3.9pF	±0.25pF	CLR1C3R9CA1INN#
366	0.138	25	COG	4pF	±0.05pF	CLR1C040AA1INN#
367	0.138	25	COG	4pF	±0.1pF	CLR1C040BA1INN#
368	0.138	25	COG	4pF	±0.25pF	CLR1C040CA1INN#
369	0.138	25	COG	4.1pF	±0.05pF	CLR1C4R1AA1INN#
370	0.138	25	COG	4.1pF	±0.1pF	CLR1C4R1BA1INN#
371	0.138	25	COG	4.1pF	±0.25pF	CLR1C4R1CA1INN#
372	0.138	25	COG	4.2pF	±0.05pF	CLR1C4R2AA1INN#
373	0.138	25	COG	4.2pF	±0.1pF	CLR1C4R2BA1INN#
374	0.138	25	COG	4.2pF	±0.25pF	CLR1C4R2CA1INN#
375	0.138	25	COG	4.3pF	±0.05pF	CLR1C4R3AA1INN#
376	0.138	25	COG	4.3pF	±0.1pF	CLR1C4R3BA1INN#
377	0.138	25	COG	4.3pF	±0.25pF	CLR1C4R3CA1INN#
378	0.138	25	COG	4.4pF	±0.05pF	CLR1C4R4AA1INN#
379	0.138	25	COG	4.4pF	±0.1pF	CLR1C4R4BA1INN#
380	0.138	25	COG	4.4pF	±0.25pF	CLR1C4R4CA1INN#
381	0.138	25	COG	4.5pF	±0.05pF	CLR1C4R5AA1INN#
382	0.138	25	COG	4.5pF	±0.1pF	CLR1C4R5BA1INN#
383	0.138	25	COG	4.5pF	±0.25pF	CLR1C4R5CA1INN#
384	0.138	25	COG	4.6pF	±0.05pF	CLR1C4R6AA1INN#
385	0.138	25	COG	4.6pF	±0.1pF	CLR1C4R6BA1INN#



# Normal Capacitors\_Standard

Size Code (inch/mm) : 008004/0201

No.	Thickness Max. (mm)	Rated Voltage (Vdc)	TCC	Capacitance	Capacitance Tolerance	Part Number
386	0.138	25	COG	4.6pF	±0.25pF	CLR1C4R6CA1INN#
387	0.138	25	COG	4.7pF	±0.05pF	CLR1C4R7AA1INN#
388	0.138	25	COG	4.7pF	±0.1pF	CLR1C4R7BA1INN#
389	0.138	25	COG	4.7pF	±0.25pF	CLR1C4R7CA1INN#
390	0.138	25	COG	4.8pF	±0.05pF	CLR1C4R8AA1INN#
391	0.138	25	COG	4.8pF	±0.1pF	CLR1C4R8BA1INN#
392	0.138	25	COG	4.8pF	±0.25pF	CLR1C4R8CA1INN#
393	0.138	25	COG	4.9pF	±0.05pF	CLR1C4R9AA1INN#
394	0.138	25	COG	4.9pF	±0.1pF	CLR1C4R9BA1INN#
395	0.138	25	COG	4.9pF	±0.25pF	CLR1C4R9CA1INN#
396	0.138	25	COG	5pF	±0.05pF	CLR1C050AA1INN#
397	0.138	25	COG	5pF	±0.1pF	CLR1C050BA1INN#
398	0.138	25	COG	5pF	±0.1pF	CLR1C050BA1NNN#
399	0.138	25	COG	5pF	±0.25pF	CLR1C050CA1INN#
400	0.138	25	COG	5.1pF	±0.05pF	CLR1C5R1AA1INN#
401	0.138	25	COG	5.1pF	±0.1pF	CLR1C5R1BA1INN#
402	0.138	25	COG	5.1pF	±0.25pF	CLR1C5R1CA1INN#
403	0.138	25	COG	5.1pF	±0.5pF	CLR1C5R1DA1INN#
404	0.138	25	COG	5.2pF	±0.05pF	CLR1C5R2AA1INN#
405	0.138	25	COG	5.2pF	±0.1pF	CLR1C5R2BA1INN#
406	0.138	25	COG	5.2pF	±0.25pF	CLR1C5R2CA1INN#
407	0.138	25	COG	5.2pF	±0.5pF	CLR1C5R2DA1INN#
408	0.138	25	COG	5.3pF	±0.05pF	CLR1C5R3AA1INN#
409	0.138	25	COG	5.3pF	±0.1pF	CLR1C5R3BA1INN#
410	0.138	25	COG	5.3pF	±0.25pF	CLR1C5R3CA1INN#
411	0.138	25	COG	5.3pF	±0.5pF	CLR1C5R3DA1INN#
412	0.138	25	COG	5.4pF	±0.05pF	CLR1C5R4AA1INN#
413	0.138	25	COG	5.4pF	±0.1pF	CLR1C5R4BA1INN#
414	0.138	25	COG	5.4pF	±0.25pF	CLR1C5R4CA1INN#
415	0.138	25	COG	5.4pF	±0.5pF	CLR1C5R4DA1INN#
416	0.138	25	COG	5.5pF	±0.05pF	CLR1C5R5AA1INN#
417	0.138	25	COG	5.5pF	±0.1pF	CLR1C5R5BA1INN#
418	0.138	25	COG	5.5pF	±0.25pF	CLR1C5R5CA1INN#
419	0.138	25	COG	5.5pF	±0.5pF	CLR1C5R5DA1INN#
420	0.138	25	COG	5.6pF	±0.05pF	CLR1C5R6AA1INN#
421	0.138	25	COG	5.6pF	±0.1pF	CLR1C5R6BA1INN#
422	0.138	25	COG	5.6pF	±0.25pF	CLR1C5R6CA1INN#
423	0.138	25	COG	5.6pF	±0.5pF	CLR1C5R6DA1INN#
424	0.138	25	COG	5.7pF	±0.05pF	CLR1C5R7AA1INN#
425	0.138	25	COG	5.7pF	±0.1pF	CLR1C5R7BA1INN#
426	0.138	25	COG	5.7pF	±0.25pF	CLR1C5R7CA1INN#
427	0.138	25	COG	5.7pF	±0.5pF	CLR1C5R7DA1INN#
428	0.138	25	COG	5.8pF	±0.05pF	CLR1C5R8AA1INN#
429	0.138	25	COG	5.8pF	±0.1pF	CLR1C5R8BA1INN#
430	0.138	25	COG	5.8pF	±0.25pF	CLR1C5R8CA1INN#

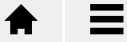

# Normal Capacitors\_Standard

Size Code (inch/mm) : 008004/0201

No.	Thickness Max. (mm)	Rated Voltage (Vdc)	TCC	Capacitance	Capacitance Tolerance	Part Number
431	0.138	25	COG	5.8pF	±0.5pF	CLR1C5R8DA1INN#
432	0.138	25	COG	5.9pF	±0.05pF	CLR1C5R9AA1INN#
433	0.138	25	COG	5.9pF	±0.1pF	CLR1C5R9BA1INN#
434	0.138	25	COG	5.9pF	±0.25pF	CLR1C5R9CA1INN#
435	0.138	25	COG	5.9pF	±0.5pF	CLR1C5R9DA1INN#
436	0.138	25	COG	6pF	±0.05pF	CLR1C060AA1INN#
437	0.138	25	COG	6pF	±0.1pF	CLR1C060BA1INN#
438	0.138	25	COG	6pF	±0.25pF	CLR1C060CA1INN#
439	0.138	25	COG	6pF	±0.5pF	CLR1C060DA1INN#
440	0.138	25	COG	6.1pF	±0.05pF	CLR1C6R1AA1INN#
441	0.138	25	COG	6.1pF	±0.1pF	CLR1C6R1BA1INN#
442	0.138	25	COG	6.1pF	±0.25pF	CLR1C6R1CA1INN#
443	0.138	25	COG	6.1pF	±0.5pF	CLR1C6R1DA1INN#
444	0.138	25	COG	6.2pF	±0.05pF	CLR1C6R2AA1INN#
445	0.138	25	COG	6.2pF	±0.1pF	CLR1C6R2BA1INN#
446	0.138	25	COG	6.2pF	±0.25pF	CLR1C6R2CA1INN#
447	0.138	25	COG	6.2pF	±0.5pF	CLR1C6R2DA1INN#
448	0.138	25	COG	6.3pF	±0.05pF	CLR1C6R3AA1INN#
449	0.138	25	COG	6.3pF	±0.1pF	CLR1C6R3BA1INN#
450	0.138	25	COG	6.3pF	±0.25pF	CLR1C6R3CA1INN#
451	0.138	25	COG	6.3pF	±0.5pF	CLR1C6R3DA1INN#
452	0.138	25	COG	6.4pF	±0.05pF	CLR1C6R4AA1INN#
453	0.138	25	COG	6.4pF	±0.1pF	CLR1C6R4BA1INN#
454	0.138	25	COG	6.4pF	±0.25pF	CLR1C6R4CA1INN#
455	0.138	25	COG	6.4pF	±0.5pF	CLR1C6R4DA1INN#
456	0.138	25	COG	6.5pF	±0.05pF	CLR1C6R5AA1INN#
457	0.138	25	COG	6.5pF	±0.1pF	CLR1C6R5BA1INN#
458	0.138	25	COG	6.5pF	±0.25pF	CLR1C6R5CA1INN#
459	0.138	25	COG	6.5pF	±0.5pF	CLR1C6R5DA1INN#
460	0.138	25	COG	6.6pF	±0.05pF	CLR1C6R6AA1INN#
461	0.138	25	COG	6.6pF	±0.1pF	CLR1C6R6BA1INN#
462	0.138	25	COG	6.6pF	±0.25pF	CLR1C6R6CA1INN#
463	0.138	25	COG	6.6pF	±0.5pF	CLR1C6R6DA1INN#
464	0.138	25	COG	6.7pF	±0.05pF	CLR1C6R7AA1INN#
465	0.138	25	COG	6.7pF	±0.1pF	CLR1C6R7BA1INN#
466	0.138	25	COG	6.7pF	±0.25pF	CLR1C6R7CA1INN#
467	0.138	25	COG	6.7pF	±0.5pF	CLR1C6R7DA1INN#
468	0.138	25	COG	6.8pF	±0.05pF	CLR1C6R8AA1INN#
469	0.138	25	COG	6.8pF	±0.1pF	CLR1C6R8BA1INN#
470	0.138	25	COG	6.8pF	±0.25pF	CLR1C6R8CA1INN#
471	0.138	25	COG	6.8pF	±0.5pF	CLR1C6R8DA1INN#
472	0.138	25	COG	6.9pF	±0.05pF	CLR1C6R9AA1INN#
473	0.138	25	COG	6.9pF	±0.1pF	CLR1C6R9BA1INN#
474	0.138	25	COG	6.9pF	±0.25pF	CLR1C6R9CA1INN#
475	0.138	25	COG	6.9pF	±0.5pF	CLR1C6R9DA1INN#

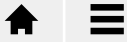

# Normal Capacitors\_Standard

Size Code (inch/mm) : 008004/0201

No.	Thickness Max. (mm)	Rated Voltage (Vdc)	TCC	Capacitance	Capacitance Tolerance	Part Number
476	0.138	25	COG	7pF	±0.05pF	CLR1C070AA1INN#
477	0.138	25	COG	7pF	±0.1pF	CLR1C070BA1INN#
478	0.138	25	COG	7pF	±0.25pF	CLR1C070CA1INN#
479	0.138	25	COG	7pF	±0.5pF	CLR1C070DA1INN#
480	0.138	25	COG	7.1pF	±0.05pF	CLR1C7R1AA1INN#
481	0.138	25	COG	7.1pF	±0.1pF	CLR1C7R1BA1INN#
482	0.138	25	COG	7.1pF	±0.25pF	CLR1C7R1CA1INN#
483	0.138	25	COG	7.1pF	±0.5pF	CLR1C7R1DA1INN#
484	0.138	25	COG	7.2pF	±0.05pF	CLR1C7R2AA1INN#
485	0.138	25	COG	7.2pF	±0.1pF	CLR1C7R2BA1INN#
486	0.138	25	COG	7.2pF	±0.25pF	CLR1C7R2CA1INN#
487	0.138	25	COG	7.2pF	±0.5pF	CLR1C7R2DA1INN#
488	0.138	25	COG	7.3pF	±0.05pF	CLR1C7R3AA1INN#
489	0.138	25	COG	7.3pF	±0.1pF	CLR1C7R3BA1INN#
490	0.138	25	COG	7.3pF	±0.25pF	CLR1C7R3CA1INN#
491	0.138	25	COG	7.3pF	±0.5pF	CLR1C7R3DA1INN#
492	0.138	25	COG	7.4pF	±0.05pF	CLR1C7R4AA1INN#
493	0.138	25	COG	7.4pF	±0.1pF	CLR1C7R4BA1INN#
494	0.138	25	COG	7.4pF	±0.25pF	CLR1C7R4CA1INN#
495	0.138	25	COG	7.4pF	±0.5pF	CLR1C7R4DA1INN#
496	0.138	25	COG	7.5pF	±0.05pF	CLR1C7R5AA1INN#
497	0.138	25	COG	7.5pF	±0.1pF	CLR1C7R5BA1INN#
498	0.138	25	COG	7.5pF	±0.25pF	CLR1C7R5CA1INN#
499	0.138	25	COG	7.5pF	±0.5pF	CLR1C7R5DA1INN#
500	0.138	25	COG	7.6pF	±0.05pF	CLR1C7R6AA1INN#
501	0.138	25	COG	7.6pF	±0.1pF	CLR1C7R6BA1INN#
502	0.138	25	COG	7.6pF	±0.25pF	CLR1C7R6CA1INN#
503	0.138	25	COG	7.6pF	±0.5pF	CLR1C7R6DA1INN#
504	0.138	25	COG	7.7pF	±0.05pF	CLR1C7R7AA1INN#
505	0.138	25	COG	7.7pF	±0.1pF	CLR1C7R7BA1INN#
506	0.138	25	COG	7.7pF	±0.25pF	CLR1C7R7CA1INN#
507	0.138	25	COG	7.7pF	±0.5pF	CLR1C7R7DA1INN#
508	0.138	25	COG	7.8pF	±0.05pF	CLR1C7R8AA1INN#
509	0.138	25	COG	7.8pF	±0.1pF	CLR1C7R8BA1INN#
510	0.138	25	COG	7.8pF	±0.25pF	CLR1C7R8CA1INN#
511	0.138	25	COG	7.8pF	±0.5pF	CLR1C7R8DA1INN#
512	0.138	25	COG	7.9pF	±0.05pF	CLR1C7R9AA1INN#
513	0.138	25	COG	7.9pF	±0.1pF	CLR1C7R9BA1INN#
514	0.138	25	COG	7.9pF	±0.25pF	CLR1C7R9CA1INN#
515	0.138	25	COG	7.9pF	±0.5pF	CLR1C7R9DA1INN#
516	0.138	25	COG	8pF	±0.05pF	CLR1C080AA1INN#
517	0.138	25	COG	8pF	±0.1pF	CLR1C080BA1INN#
518	0.138	25	COG	8pF	±0.25pF	CLR1C080CA1INN#
519	0.138	25	COG	8pF	±0.5pF	CLR1C080DA1INN#
520	0.138	25	COG	8.1pF	±0.05pF	CLR1C8R1AA1INN#

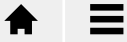

# Normal Capacitors\_Standard

Size Code (inch/mm) : 008004/0201

No.	Thickness Max. (mm)	Rated Voltage (Vdc)	TCC	Capacitance	Capacitance Tolerance	Part Number
521	0.138	25	COG	8.1pF	±0.1pF	CLR1C8R1BA1INN#
522	0.138	25	COG	8.1pF	±0.25pF	CLR1C8R1CA1INN#
523	0.138	25	COG	8.1pF	±0.5pF	CLR1C8R1DA1INN#
524	0.138	25	COG	8.2pF	±0.05pF	CLR1C8R2AA1INN#
525	0.138	25	COG	8.2pF	±0.1pF	CLR1C8R2BA1INN#
526	0.138	25	COG	8.2pF	±0.25pF	CLR1C8R2CA1INN#
527	0.138	25	COG	8.2pF	±0.5pF	CLR1C8R2DA1INN#
528	0.138	25	COG	8.3pF	±0.05pF	CLR1C8R3AA1INN#
529	0.138	25	COG	8.3pF	±0.1pF	CLR1C8R3BA1INN#
530	0.138	25	COG	8.3pF	±0.25pF	CLR1C8R3CA1INN#
531	0.138	25	COG	8.3pF	±0.5pF	CLR1C8R3DA1INN#
532	0.138	25	COG	8.4pF	±0.05pF	CLR1C8R4AA1INN#
533	0.138	25	COG	8.4pF	±0.1pF	CLR1C8R4BA1INN#
534	0.138	25	COG	8.4pF	±0.25pF	CLR1C8R4CA1INN#
535	0.138	25	COG	8.4pF	±0.5pF	CLR1C8R4DA1INN#
536	0.138	25	COG	8.5pF	±0.05pF	CLR1C8R5AA1INN#
537	0.138	25	COG	8.5pF	±0.1pF	CLR1C8R5BA1INN#
538	0.138	25	COG	8.5pF	±0.25pF	CLR1C8R5CA1INN#
539	0.138	25	COG	8.5pF	±0.5pF	CLR1C8R5DA1INN#
540	0.138	25	COG	8.6pF	±0.05pF	CLR1C8R6AA1INN#
541	0.138	25	COG	8.6pF	±0.1pF	CLR1C8R6BA1INN#
542	0.138	25	COG	8.6pF	±0.25pF	CLR1C8R6CA1INN#
543	0.138	25	COG	8.6pF	±0.5pF	CLR1C8R6DA1INN#
544	0.138	25	COG	8.7pF	±0.05pF	CLR1C8R7AA1INN#
545	0.138	25	COG	8.7pF	±0.1pF	CLR1C8R7BA1INN#
546	0.138	25	COG	8.7pF	±0.25pF	CLR1C8R7CA1INN#
547	0.138	25	COG	8.7pF	±0.5pF	CLR1C8R7DA1INN#
548	0.138	25	COG	8.8pF	±0.05pF	CLR1C8R8AA1INN#
549	0.138	25	COG	8.8pF	±0.1pF	CLR1C8R8BA1INN#
550	0.138	25	COG	8.8pF	±0.25pF	CLR1C8R8CA1INN#
551	0.138	25	COG	8.8pF	±0.5pF	CLR1C8R8DA1INN#
552	0.138	25	COG	8.9pF	±0.05pF	CLR1C8R9AA1INN#
553	0.138	25	COG	8.9pF	±0.1pF	CLR1C8R9BA1INN#
554	0.138	25	COG	8.9pF	±0.25pF	CLR1C8R9CA1INN#
555	0.138	25	COG	8.9pF	±0.5pF	CLR1C8R9DA1INN#
556	0.138	25	COG	9pF	±0.05pF	CLR1C090AA1INN#
557	0.138	25	COG	9pF	±0.1pF	CLR1C090BA1INN#
558	0.138	25	COG	9pF	±0.25pF	CLR1C090CA1INN#
559	0.138	25	COG	9pF	±0.5pF	CLR1C090DA1INN#
560	0.138	25	COG	9.1pF	±0.05pF	CLR1C9R1AA1INN#
561	0.138	25	COG	9.1pF	±0.1pF	CLR1C9R1BA1INN#
562	0.138	25	COG	9.1pF	±0.25pF	CLR1C9R1CA1INN#
563	0.138	25	COG	9.1pF	±0.5pF	CLR1C9R1DA1INN#
564	0.138	25	COG	9.2pF	±0.05pF	CLR1C9R2AA1INN#
565	0.138	25	COG	9.2pF	±0.1pF	CLR1C9R2BA1INN#



# Normal Capacitors\_Standard

Size Code (inch/mm) : 008004/0201

No.	Thickness Max. (mm)	Rated Voltage (Vdc)	TCC	Capacitance	Capacitance Tolerance	Part Number
566	0.138	25	COG	9.2pF	±0.25pF	CLR1C9R2CA1INN#
567	0.138	25	COG	9.2pF	±0.5pF	CLR1C9R2DA1INN#
568	0.138	25	COG	9.3pF	±0.05pF	CLR1C9R3AA1INN#
569	0.138	25	COG	9.3pF	±0.1pF	CLR1C9R3BA1INN#
570	0.138	25	COG	9.3pF	±0.25pF	CLR1C9R3CA1INN#
571	0.138	25	COG	9.3pF	±0.5pF	CLR1C9R3DA1INN#
572	0.138	25	COG	9.4pF	±0.05pF	CLR1C9R4AA1INN#
573	0.138	25	COG	9.4pF	±0.1pF	CLR1C9R4BA1INN#
574	0.138	25	COG	9.4pF	±0.25pF	CLR1C9R4CA1INN#
575	0.138	25	COG	9.4pF	±0.5pF	CLR1C9R4DA1INN#
576	0.138	25	COG	9.5pF	±0.05pF	CLR1C9R5AA1INN#
577	0.138	25	COG	9.5pF	±0.1pF	CLR1C9R5BA1INN#
578	0.138	25	COG	9.5pF	±0.25pF	CLR1C9R5CA1INN#
579	0.138	25	COG	9.5pF	±0.5pF	CLR1C9R5DA1INN#
580	0.138	25	COG	9.6pF	±0.05pF	CLR1C9R6AA1INN#
581	0.138	25	COG	9.6pF	±0.1pF	CLR1C9R6BA1INN#
582	0.138	25	COG	9.6pF	±0.25pF	CLR1C9R6CA1INN#
583	0.138	25	COG	9.6pF	±0.5pF	CLR1C9R6DA1INN#
584	0.138	25	COG	9.7pF	±0.05pF	CLR1C9R7AA1INN#
585	0.138	25	COG	9.7pF	±0.1pF	CLR1C9R7BA1INN#
586	0.138	25	COG	9.7pF	±0.25pF	CLR1C9R7CA1INN#
587	0.138	25	COG	9.7pF	±0.5pF	CLR1C9R7DA1INN#
588	0.138	25	COG	9.8pF	±0.05pF	CLR1C9R8AA1INN#
589	0.138	25	COG	9.8pF	±0.1pF	CLR1C9R8BA1INN#
590	0.138	25	COG	9.8pF	±0.25pF	CLR1C9R8CA1INN#
591	0.138	25	COG	9.8pF	±0.5pF	CLR1C9R8DA1INN#
592	0.138	25	COG	9.9pF	±0.05pF	CLR1C9R9AA1INN#
593	0.138	25	COG	9.9pF	±0.1pF	CLR1C9R9BA1INN#
594	0.138	25	COG	9.9pF	±0.25pF	CLR1C9R9CA1INN#
595	0.138	25	COG	9.9pF	±0.5pF	CLR1C9R9DA1INN#
596	0.138	25	COG	10pF	±0.05pF	CLR1C100AA1INN#
597	0.138	25	COG	10pF	±0.1pF	CLR1C100BA1INN#
598	0.138	25	COG	10pF	±0.1pF	CLR1C100BA1NIN#
599	0.138	25	COG	10pF	±0.25pF	CLR1C100CA1INN#
600	0.138	25	COG	10pF	±0.5pF	CLR1C100DA1INN#
601	0.138	25	COG	10pF	±2%	CLR1C100GA1INN#
602	0.138	25	COG	10pF	±5%	CLR1C100JA1INN#
603	0.138	25	COG	18pF	±5%	CLR1C180JA1NIN#
604	0.138	25	COG	36pF	±5%	CLR1C360JA1NIN#
605	0.138	25	COG	47pF	±5%	CLR1C470JA1NIN#
606	0.138	25	COG	56pF	±5%	CLR1C560JA1NIN#

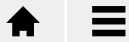

# Normal Capacitors\_Standard

Size Code (inch/mm) : 01005/0402

No.	Thickness Max. (mm)	Rated Voltage (Vdc)	TCC	Capacitance	Capacitance Tolerance	Part Number
1	0.22	6.3	COG	100pF	±5%	CL02C101JQ2NNN#
2	0.22	16	COG	10pF	±5%	CL02C100JO2ANN#
3	0.22	16	COG	10pF	±5%	CL02C100JO2NNN#
4	0.22	16	COG	11pF	±5%	CL02C110JO2NNN#
5	0.22	16	COG	13pF	±5%	CL02C130JO2NNN#
6	0.22	16	COG	16pF	±5%	CL02C160JO2NNN#
7	0.22	16	COG	18pF	±5%	CL02C180JO2NNN#
8	0.22	16	COG	20pF	±5%	CL02C200JO2NNN#
9	0.22	16	COG	22pF	±5%	CL02C220JO2NNN#
10	0.22	16	COG	24pF	±5%	CL02C240JO2NNN#
11	0.22	16	COG	27pF	±5%	CL02C270JO2NNN#
12	0.22	16	COG	30pF	±5%	CL02C300JO2NNN#
13	0.22	16	COG	33pF	±5%	CL02C330JO2ANN#
14	0.22	16	COG	33pF	±5%	CL02C330JO2NNN#
15	0.22	16	COG	36pF	±5%	CL02C360JO2NNN#
16	0.22	16	COG	39pF	±5%	CL02C390JO2NNN#
17	0.22	16	COG	43pF	±5%	CL02C430JO2NNN#
18	0.22	16	COG	47pF	±5%	CL02C470JO2ANN#
19	0.22	16	COG	51pF	±5%	CL02C510JO2NNN#
20	0.22	16	COG	56pF	±5%	CL02C560JO2NNN#
21	0.22	16	COG	62pF	±5%	CL02C620JO2NNN#
22	0.22	16	COG	68pF	±5%	CL02C680JO2NNN#
23	0.22	16	COG	75pF	±5%	CL02C750JO2NNN#
24	0.22	16	COG	82pF	±5%	CL02C820JO2NNN#
25	0.22	16	COG	91pF	±5%	CL02C910JO2NNN#
26	0.22	16	COG	100pF	±5%	CL02C101JO2NNN#
27	0.22	25	COG	10pF	±5%	CL02C100JA2NNN#
28	0.22	25	COG	11pF	±5%	CL02C110JA2NNN#
29	0.22	25	COG	12pF	±5%	CL02C120JA2NNN#
30	0.22	25	COG	13pF	±5%	CL02C130JA2NNN#
31	0.22	25	COG	15pF	±5%	CL02C150JA2NNN#
32	0.22	25	COG	16pF	±5%	CL02C160JA2NNN#
33	0.22	25	COG	18pF	±5%	CL02C180JA2NNN#
34	0.22	25	COG	20pF	±5%	CL02C200JA2NNN#
35	0.22	25	COG	22pF	±5%	CL02C220JA2NNN#
36	0.22	25	COG	24pF	±5%	CL02C240JA2NNN#
37	0.22	25	COG	27pF	±5%	CL02C270JA2NNN#
38	0.22	25	COG	30pF	±5%	CL02C300JA2NNN#
39	0.22	25	COG	33pF	±5%	CL02C330JA2NNN#
40	0.22	25	COG	36pF	±5%	CL02C360JA2NNN#
41	0.22	25	COG	39pF	±5%	CL02C390JA2NNN#
42	0.22	25	COG	43pF	±5%	CL02C430JA2NNN#
43	0.22	25	COG	47pF	±5%	CL02C470JA2NNN#
44	0.22	25	COG	51pF	±5%	CL02C510JA2NNN#
45	0.22	25	COG	56pF	±5%	CL02C560JA2NNN#



# Normal Capacitors\_Standard

Size Code (inch/mm) : 01005/0402

No.	Thickness Max. (mm)	Rated Voltage (Vdc)	TCC	Capacitance	Capacitance Tolerance	Part Number
46	0.22	25	COG	62pF	±5%	CL02C620JA2NNN#
47	0.22	25	COG	68pF	±5%	CL02C680JA2NNN#
48	0.22	25	COG	75pF	±5%	CL02C750JA2NNN#
49	0.22	25	COG	82pF	±5%	CL02C820JA2NNN#
50	0.22	25	COG	91pF	±5%	CL02C910JA2NNN#
51	0.22	25	COG	100pF	±5%	CL02C101JA2NNN#
52	0.22	25	COG	220pF	±5%	CL02C221JA2NNN#
53	0.22	50	COG	100pF	±5%	CL02C101JB2NNN#

Size Code (inch/mm) : 0201/0603

No.	Thickness Max. (mm)	Rated Voltage (Vdc)	TCC	Capacitance	Capacitance Tolerance	Part Number
1	0.33	25	COG	0.2pF	±0.1pF	CL03C0R2BA3GNN#
2	0.33	25	COG	0.5pF	±0.1pF	CL03C0R5BA3GNN#
3	0.33	25	COG	0.5pF	±0.25pF	CL03C0R5CA3GNN#
4	0.33	25	COG	1pF	±0.1pF	CL03C010BA3GNN#
5	0.33	25	COG	1pF	±0.25pF	CL03C010CA3GNN#
6	0.33	25	COG	1.2pF	±0.1pF	CL03C1R2BA3GNN#
7	0.33	25	COG	1.2pF	±0.25pF	CL03C1R2CA3GNN#
8	0.33	25	COG	1.5pF	±0.25pF	CL03C1R5CA3GNN#
9	0.33	25	COG	1.8pF	±0.25pF	CL03C1R8CA3GNN#
10	0.33	25	COG	2.2pF	±0.1pF	CL03C2R2BA3GNN#
11	0.33	25	COG	2.2pF	±0.25pF	CL03C2R2CA3GNN#
12	0.33	25	COG	2.7pF	±0.25pF	CL03C2R7CA3GNN#
13	0.33	25	COG	3pF	±0.1pF	CL03C030BA3GNN#
14	0.33	25	COG	4.7pF	±0.25pF	CL03C4R7CA3GNN#
15	0.33	25	COG	5pF	±0.25pF	CL03C050CA3GNN#
16	0.33	25	COG	5.6pF	±0.25pF	CL03C5R6CA3GNN#
17	0.33	25	COG	6pF	±0.5pF	CL03C060DA3GNN#
18	0.33	25	COG	6.8pF	±0.25pF	CL03C6R8CA3GNN#
19	0.33	25	COG	6.8pF	±0.5pF	CL03C6R8DA3GNN#
20	0.33	25	COG	9pF	±0.25pF	CL03C090CA3GNN#
21	0.33	25	COG	10pF	±5%	CL03C100JA3GNN#
22	0.33	25	COG	10pF	±5%	CL03C100JA3NNN#
23	0.33	25	COG	11pF	±5%	CL03C110JA3GNN#
24	0.33	25	COG	11pF	±5%	CL03C110JA3NNN#
25	0.33	25	COG	12pF	±5%	CL03C120JA3GNN#
26	0.33	25	COG	12pF	±5%	CL03C120JA3NNN#
27	0.33	25	COG	13pF	±5%	CL03C130JA3GNN#
28	0.33	25	COG	15pF	±5%	CL03C150JA3NNN#
29	0.33	25	COG	16pF	±5%	CL03C160JA3GNN#
30	0.33	25	COG	18pF	±5%	CL03C180JA3GNN#

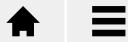

# Normal Capacitors\_Standard

Size Code (inch/mm) : 0201/0603

No.	Thickness Max. (mm)	Rated Voltage (Vdc)	TCC	Capacitance	Capacitance Tolerance	Part Number
31	0.33	25	COG	18pF	±5%	CL03C180JA3NNN#
32	0.33	25	COG	20pF	±5%	CL03C200JA3GNN#
33	0.33	25	COG	20pF	±5%	CL03C200JA3NNN#
34	0.33	25	COG	22pF	±5%	CL03C220JA3GNN#
35	0.33	25	COG	22pF	±5%	CL03C220JA3NNN#
36	0.33	25	COG	24pF	±5%	CL03C240JA3GNN#
37	0.33	25	COG	27pF	±5%	CL03C270JA3GNN#
38	0.33	25	COG	27pF	±5%	CL03C270JA3NNN#
39	0.33	25	COG	30pF	±5%	CL03C300JA3GNN#
40	0.33	25	COG	30pF	±5%	CL03C300JA3NNN#
41	0.33	25	COG	33pF	±5%	CL03C330JA3NNN#
42	0.33	25	COG	39pF	±5%	CL03C390JA3NNN#
43	0.33	25	COG	47pF	±5%	CL03C470JA3NNN#
44	0.33	25	COG	56pF	±5%	CL03C560JA3NNN#
45	0.33	25	COG	68pF	±5%	CL03C680JA3NNN#
46	0.33	25	COG	82pF	±5%	CL03C820JA3NNN#
47	0.33	25	COG	100pF	±5%	CL03C101JA3NNN#
48	0.33	50	COG	1pF	±0.1pF	CL03C010BB3GNN#
49	0.33	50	COG	1.2pF	±0.1pF	CL03C1R2BB3GNN#
50	0.33	50	COG	2pF	±0.1pF	CL03C020BB3GNN#
51	0.33	50	COG	2.7pF	±0.1pF	CL03C2R7BB3GNN#
52	0.33	50	COG	3.3pF	±0.1pF	CL03C3R3BB3GNN#
53	0.33	50	COG	10pF	±5%	CL03C100JB3GNN#
54	0.33	50	COG	10pF	±5%	CL03C100JB3NNN#
55	0.33	50	COG	12pF	±5%	CL03C120JB3NNN#
56	0.33	50	COG	15pF	±5%	CL03C150JB3NNN#
57	0.33	50	COG	22pF	±5%	CL03C220JB3NNN#
58	0.33	50	COG	27pF	±5%	CL03C270JB3GNN#
59	0.33	50	COG	27pF	±5%	CL03C270JB3NNN#
60	0.33	50	COG	33pF	±5%	CL03C330JB3NNN#
61	0.33	50	COG	39pF	±2%	CL03C390GB3NNN#
62	0.33	50	COG	39pF	±5%	CL03C390JB3NNN#
63	0.33	50	COG	47pF	±5%	CL03C470JB3NNN#
64	0.33	50	COG	100pF	±5%	CL03C101JB3NNN#
65	0.33	100	COG	100pF	±5%	CL03C101JC3NNN#



# Normal Capacitors\_Standard

Size Code (inch/mm) : 0402/1005

No.	Thickness Max. (mm)	Rated Voltage (Vdc)	TCC	Capacitance	Capacitance Tolerance	Part Number
1	0.55	16	COG	1nF	±5%	CL05C102J05NNN#
2	0.55	16	COG	100pF	±5%	CL05C101J05NNN#
3	0.55	16	COG	220pF	±5%	CL05C221J05NNN#
4	0.55	25	COG	1nF	±5%	CL05C102JA5NFN#
5	0.55	25	COG	20pF	±5%	CL05C200JA5NNN#
6	0.55	25	COG	22pF	±5%	CL05C220JA5NNN#
7	0.55	25	COG	27pF	±5%	CL05C270JA5NNN#
8	0.55	25	COG	56pF	±5%	CL05C560JA5NNN#
9	0.55	25	COG	82pF	±5%	CL05C820JA5NNN#
10	0.55	25	COG	180pF	±5%	CL05C181JA5NNN#
11	0.55	25	COG	560pF	±5%	CL05C561JA5NNN#
12	0.55	50	COG	1nF	±5%	CL05C102JB5NNN#
13	0.55	50	COG	1pF	±0.25pF	CL05C010CB5NNN#
14	0.55	50	COG	3.3pF	±0.25pF	CL05C3R3CB5NNN#
15	0.55	50	COG	3.9pF	±0.25pF	CL05C3R9CB5NNN#
16	0.55	50	COG	4.7pF	±0.25pF	CL05C4R7CB5NNN#
17	0.55	50	COG	5pF	±0.25pF	CL05C050CB5NNN#
18	0.55	50	COG	6.8pF	±0.25pF	CL05C6R8CB5NNN#
19	0.55	50	COG	8.2pF	±0.25pF	CL05C8R2CB5NNN#
20	0.55	50	COG	9pF	±0.25pF	CL05C090CB5NNN#
21	0.55	50	COG	9pF	±0.5pF	CL05C090DB5NNN#
22	0.55	50	COG	10pF	±0.5pF	CL05C100DB5NNN#
23	0.55	50	COG	10pF	±5%	CL05C100JB5NCN#
24	0.55	50	COG	10pF	±5%	CL05C100JB5NFN#
25	0.55	50	COG	10pF	±5%	CL05C100JB5NNN#
26	0.55	50	COG	11pF	±5%	CL05C110JB5NNN#
27	0.55	50	COG	12pF	±5%	CL05C120JB5NCN#
28	0.55	50	COG	12pF	±5%	CL05C120JB5NNN#
29	0.55	50	COG	13pF	±5%	CL05C130JB5NCN#
30	0.55	50	COG	15pF	±5%	CL05C150JB5NCN#
31	0.55	50	COG	15pF	±5%	CL05C150JB5NNN#
32	0.55	50	COG	16pF	±5%	CL05C160JB5NCN#
33	0.55	50	COG	17pF	±5%	CL05C170JB5NNN#
34	0.55	50	COG	18pF	±2%	CL05C180GB5NNN#
35	0.55	50	COG	18pF	±5%	CL05C180JB5NCN#
36	0.55	50	COG	18pF	±5%	CL05C180JB5NFN#
37	0.55	50	COG	18pF	±5%	CL05C180JB5NNN#
38	0.55	50	COG	19pF	±5%	CL05C190JB5NNN#
39	0.55	50	COG	22pF	±5%	CL05C220JB5NCN#
40	0.55	50	COG	22pF	±5%	CL05C220JB5NFN#

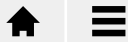

# Normal Capacitors\_Standard

Size Code (inch/mm) : 0402/1005

No.	Thickness Max. (mm)	Rated Voltage (Vdc)	TCC	Capacitance	Capacitance Tolerance	Part Number
41	0.55	50	COG	22pF	±5%	CL05C220JB5NHN#
42	0.55	50	COG	24pF	±5%	CL05C240JB5NHN#
43	0.55	50	COG	24pF	±5%	CL05C240JB5NNN#
44	0.55	50	COG	27pF	±5%	CL05C270JB5NHN#
45	0.55	50	COG	27pF	±5%	CL05C270JB5NNN#
46	0.55	50	COG	30pF	±5%	CL05C300JB5NHN#
47	0.55	50	COG	33pF	±5%	CL05C330JB5NHN#
48	0.55	50	COG	33pF	±5%	CL05C330JB5NFN#
49	0.55	50	COG	33pF	±5%	CL05C330JB5NNN#
50	0.55	50	COG	36pF	±5%	CL05C360JB5NNN#
51	0.55	50	COG	39pF	±5%	CL05C390JB5NHN#
52	0.55	50	COG	39pF	±5%	CL05C390JB5NNN#
53	0.55	50	COG	43pF	±5%	CL05C430JB5NNN#
54	0.55	50	COG	47pF	±5%	CL05C470JB5NHN#
55	0.55	50	COG	47pF	±5%	CL05C470JB5NFN#
56	0.55	50	COG	47pF	±5%	CL05C470JB5NNN#
57	0.55	50	COG	56pF	±5%	CL05C560JB5NNN#
58	0.55	50	COG	62pF	±5%	CL05C620JB5NHN#
59	0.55	50	COG	62pF	±5%	CL05C620JB5NNN#
60	0.55	50	COG	68pF	±5%	CL05C680JB5NHN#
61	0.55	50	COG	68pF	±5%	CL05C680JB5NFN#
62	0.55	50	COG	68pF	±5%	CL05C680JB5NNN#
63	0.55	50	COG	75pF	±5%	CL05C750JB5NNN#
64	0.55	50	COG	82pF	±5%	CL05C820JB5NHN#
65	0.55	50	COG	82pF	±5%	CL05C820JB5NNN#
66	0.55	50	COG	91pF	±5%	CL05C910JB5NNN#
67	0.55	50	COG	100pF	±5%	CL05C101JB5NHN#
68	0.55	50	COG	100pF	±5%	CL05C101JB5NFN#
69	0.55	50	COG	100pF	±5%	CL05C101JB5NNN#
70	0.55	50	COG	120pF	±5%	CL05C121JB5NNN#
71	0.55	50	COG	130pF	±5%	CL05C131JB5NNN#
72	0.55	50	COG	150pF	±5%	CL05C151JB5NFN#
73	0.55	50	COG	150pF	±5%	CL05C151JB5NNN#
74	0.55	50	COG	160pF	±5%	CL05C161JB5NNN#
75	0.55	50	COG	180pF	±5%	CL05C181JB5NNN#
76	0.55	50	COG	200pF	±5%	CL05C201JB5NNN#
77	0.55	50	COG	220pF	±5%	CL05C221JB5NFN#
78	0.55	50	COG	220pF	±5%	CL05C221JB5NNN#
79	0.55	50	COG	270pF	±5%	CL05C271JB5NNN#
80	0.55	50	COG	330pF	±5%	CL05C331JB5NFN#



# Normal Capacitors\_Standard

Size Code (inch/mm) : 0402/1005

No.	Thickness Max. (mm)	Rated Voltage (Vdc)	TCC	Capacitance	Capacitance Tolerance	Part Number
81	0.55	50	COG	330pF	±5%	CL05C331JB5NINN#
82	0.55	50	COG	390pF	±5%	CL05C391JB5NINN#
83	0.55	50	COG	390pF	±5%	CL05C391JB5NINN#
84	0.55	50	COG	470pF	±5%	CL05C471JB5NINN#
85	0.55	50	COG	680pF	±5%	CL05C681JB5NINN#
86	0.55	50	COG	680pF	±5%	CL05C681JB5NINN#
87	0.55	50	COG	820pF	±5%	CL05C821JB5NINN#
88	0.55	100	COG	1nF	±5%	CL05C102JC5NINN#
89	0.55	100	COG	12pF	±5%	CL05C120JC5NINN#
90	0.55	100	COG	15pF	±5%	CL05C150JC5NINN#
91	0.55	100	COG	18pF	±5%	CL05C180JC5NINN#
92	0.55	100	COG	27pF	±5%	CL05C270JC5NINN#
93	0.55	100	COG	30pF	±5%	CL05C300JC5NINN#
94	0.55	100	COG	33pF	±5%	CL05C330JC5NINN#
95	0.55	100	COG	39pF	±5%	CL05C390JC5NINN#
96	0.55	100	COG	47pF	±5%	CL05C470JC5NINN#
97	0.55	100	COG	68pF	±5%	CL05C680JC5NINN#
98	0.55	100	COG	82pF	±5%	CL05C820JC5NINN#
99	0.55	100	COG	100pF	±5%	CL05C101JC5NINN#
100	0.55	100	COG	220pF	±5%	CL05C221JC5NINN#
101	0.65	50	COG	4.7nF	±5%	CL05C472JB5NINN#

Size Code (inch/mm) : 0603/1608

No.	Thickness Max. (mm)	Rated Voltage (Vdc)	TCC	Capacitance	Capacitance Tolerance	Part Number
1	0.90	16	COG	1nF	±5%	CL10C102J08NINN#
2	0.90	16	COG	1.8nF	±5%	CL10C182J08NINN#
3	0.90	16	COG	2.2nF	±5%	CL10C222J08NINN#
4	0.90	25	COG	1nF	±5%	CL10C102JA8NINN#
5	0.90	25	COG	1nF	±5%	CL10C102JA8NINN#
6	0.90	25	COG	2.2nF	±5%	CL10C222JA8NINN#
7	0.90	25	COG	3.3nF	±5%	CL10C332JA8NINN#
8	0.90	25	COG	3.9nF	±5%	CL10C392JA8NINN#
9	0.90	25	COG	4.7nF	±5%	CL10C472JA8NINN#
10	0.90	25	COG	560pF	±5%	CL10C561JA8NINN#
11	0.90	25	COG	680pF	±5%	CL10C681JA8NINN#
12	0.90	25	COG	820pF	±5%	CL10C821JA8NINN#
13	0.90	50	COG	1nF	±5%	CL10C102JB8NINN#
14	0.90	50	COG	1nF	±5%	CL10C102JB8NINN#
15	0.90	50	COG	1.2nF	±5%	CL10C122JB8NINN#



# Normal Capacitors\_Standard

Size Code (inch/mm) : 0603/1608

No.	Thickness Max. (mm)	Rated Voltage (Vdc)	TCC	Capacitance	Capacitance Tolerance	Part Number
16	0.90	50	COG	1.2nF	±5%	CL10C122JB8NNN#
17	0.90	50	COG	1.5nF	±5%	CL10C152JB8NFN#
18	0.90	50	COG	1.5nF	±5%	CL10C152JB8NNN#
19	0.90	50	COG	1.8nF	±5%	CL10C182JB8NFN#
20	0.90	50	COG	1.8nF	±5%	CL10C182JB8NNN#
21	0.90	50	COG	2.2nF	±5%	CL10C222JB8NFN#
22	0.90	50	COG	2.2nF	±5%	CL10C222JB8NNN#
23	0.90	50	COG	2.7nF	±5%	CL10C272JB8NFN#
24	0.90	50	COG	2.7nF	±5%	CL10C272JB8NNN#
25	0.90	50	COG	3.3nF	±5%	CL10C332JB8NFN#
26	0.90	50	COG	3.3nF	±5%	CL10C332JB8NNN#
27	0.90	50	COG	4.7nF	±5%	CL10C472JB8NNN#
28	0.90	50	COG	4.7pF	±0.1pF	CL10C472JB8NNN#
29	0.90	50	COG	5.6nF	±5%	CL10C562JB8NNN#
30	0.90	50	COG	5.6pF	±0.1pF	CL10C562JB8NNN#
31	0.90	50	COG	10pF	±1%	CL10C100FB8NNN#
32	0.90	50	COG	10pF	±5%	CL10C100JB8NCN#
33	0.90	50	COG	10pF	±5%	CL10C100JB8NFN#
34	0.90	50	COG	10pF	±5%	CL10C100JB8NNN#
35	0.90	50	COG	11pF	±5%	CL10C110JB8NNN#
36	0.90	50	COG	12pF	±5%	CL10C120JB8NFN#
37	0.90	50	COG	12pF	±5%	CL10C120JB8NNN#
38	0.90	50	COG	13pF	±5%	CL10C130JB8NNN#
39	0.90	50	COG	14pF	±5%	CL10C140JB8NNN#
40	0.90	50	COG	15pF	±5%	CL10C150JB8NCN#
41	0.90	50	COG	15pF	±5%	CL10C150JB8NFN#
42	0.90	50	COG	15pF	±5%	CL10C150JB8NNN#
43	0.90	50	COG	18pF	±5%	CL10C180JB8NFN#
44	0.90	50	COG	18pF	±5%	CL10C180JB8NNN#
45	0.90	50	COG	20pF	±5%	CL10C200JB8NCN#
46	0.90	50	COG	20pF	±5%	CL10C200JB8NFN#
47	0.90	50	COG	20pF	±5%	CL10C200JB8NNN#
48	0.90	50	COG	22pF	±5%	CL10C220JB8NCN#
49	0.90	50	COG	22pF	±5%	CL10C220JB8NFN#
50	0.90	50	COG	22pF	±5%	CL10C220JB8NNN#
51	0.90	50	COG	24pF	±5%	CL10C240JB8NCN#
52	0.90	50	COG	25pF	±5%	CL10C250JB8NNN#
53	0.90	50	COG	27pF	±5%	CL10C270JB8NCN#
54	0.90	50	COG	27pF	±5%	CL10C270JB8NFN#
55	0.90	50	COG	27pF	±5%	CL10C270JB8NNN#



# Normal Capacitors\_Standard

Size Code (inch/mm) : 0603/1608

No.	Thickness Max. (mm)	Rated Voltage (Vdc)	TCC	Capacitance	Capacitance Tolerance	Part Number
56	0.90	50	COG	30pF	±5%	CL10C300JB8NCN#
57	0.90	50	COG	33pF	±5%	CL10C330JB8NFN#
58	0.90	50	COG	33pF	±5%	CL10C330JB8NINN#
59	0.90	50	COG	39pF	±5%	CL10C390JB8NCN#
60	0.90	50	COG	43pF	±5%	CL10C430JB8NINN#
61	0.90	50	COG	47pF	±5%	CL10C470JB8NCN#
62	0.90	50	COG	47pF	±5%	CL10C470JB8NFN#
63	0.90	50	COG	47pF	±5%	CL10C470JB8NINN#
64	0.90	50	COG	51pF	±5%	CL10C510JB8NINN#
65	0.90	50	COG	56pF	±5%	CL10C560JB8NFN#
66	0.90	50	COG	56pF	±5%	CL10C560JB8NINN#
67	0.90	50	COG	62pF	±5%	CL10C620JB8NINN#
68	0.90	50	COG	68pF	±5%	CL10C680JB8NCN#
69	0.90	50	COG	68pF	±5%	CL10C680JB8NFN#
70	0.90	50	COG	68pF	±5%	CL10C680JB8NINN#
71	0.90	50	COG	82pF	±5%	CL10C820JB8NFN#
72	0.90	50	COG	91pF	±5%	CL10C910JB8NCN#
73	0.90	50	COG	91pF	±5%	CL10C910JB8NINN#
74	0.90	50	COG	100pF	±5%	CL10C101JB8NCN#
75	0.90	50	COG	100pF	±5%	CL10C101JB8NFN#
76	0.90	50	COG	100pF	±5%	CL10C101JB8NINN#
77	0.90	50	COG	110pF	±5%	CL10C111JB8NINN#
78	0.90	50	COG	120pF	±5%	CL10C121JB8NCN#
79	0.90	50	COG	120pF	±5%	CL10C121JB8NFN#
80	0.90	50	COG	120pF	±5%	CL10C121JB8NINN#
81	0.90	50	COG	150pF	±5%	CL10C151JB8NCN#
82	0.90	50	COG	150pF	±5%	CL10C151JB8NFN#
83	0.90	50	COG	150pF	±5%	CL10C151JB8NINN#
84	0.90	50	COG	160pF	±5%	CL10C161JB8NINN#
85	0.90	50	COG	180pF	±5%	CL10C181JB8NFN#
86	0.90	50	COG	180pF	±5%	CL10C181JB8NINN#
87	0.90	50	COG	200pF	±5%	CL10C201JB8NFN#
88	0.90	50	COG	200pF	±5%	CL10C201JB8NINN#
89	0.90	50	COG	220pF	±5%	CL10C221JB8NCN#
90	0.90	50	COG	220pF	±5%	CL10C221JB8NFN#
91	0.90	50	COG	220pF	±5%	CL10C221JB8NINN#
92	0.90	50	COG	240pF	±5%	CL10C241JB8NINN#
93	0.90	50	COG	270pF	±5%	CL10C271JB8NFN#
94	0.90	50	COG	270pF	±5%	CL10C271JB8NINN#
95	0.90	50	COG	330pF	±5%	CL10C331JB8NCN#



# Normal Capacitors\_Standard

Size Code (inch/mm) : 0603/1608

No.	Thickness Max. (mm)	Rated Voltage (Vdc)	TCC	Capacitance	Capacitance Tolerance	Part Number
96	0.90	50	COG	330pF	±5%	CL10C331JB8NFN#
97	0.90	50	COG	330pF	±5%	CL10C331JB8NINN#
98	0.90	50	COG	360pF	±5%	CL10C361JB8NINN#
99	0.90	50	COG	390pF	±5%	CL10C391JB8NFN#
100	0.90	50	COG	430pF	±5%	CL10C431JB8NFN#
101	0.90	50	COG	430pF	±5%	CL10C431JB8NINN#
102	0.90	50	COG	470pF	±5%	CL10C471JB8NIN#
103	0.90	50	COG	470pF	±5%	CL10C471JB8NFN#
104	0.90	50	COG	470pF	±5%	CL10C471JB8NINN#
105	0.90	50	COG	510pF	±5%	CL10C511JB8NINN#
106	0.90	50	COG	560pF	±5%	CL10C561JB8NFN#
107	0.90	50	COG	560pF	±5%	CL10C561JB8NINN#
108	0.90	50	COG	620pF	±5%	CL10C621JB8NINN#
109	0.90	50	COG	680pF	±5%	CL10C681JB8NFN#
110	0.90	50	COG	680pF	±5%	CL10C681JB8NINN#
111	0.90	50	COG	750pF	±5%	CL10C751JB8NINN#
112	0.90	50	COG	820pF	±5%	CL10C821JB8NFN#
113	0.90	100	COG	1nF	±5%	CL10C102JC8NINN#
114	0.90	100	COG	3.9nF	±5%	CL10C392JC8NINN#
115	0.90	100	COG	10pF	±5%	CL10C100JC8NINN#
116	0.90	100	COG	12pF	±5%	CL10C120JC8NINN#
117	0.90	100	COG	18pF	±5%	CL10C180JC8NINN#
118	0.90	100	COG	39pF	±5%	CL10C390JC8NINN#
119	0.90	100	COG	47pF	±5%	CL10C470JC8NINN#
120	0.90	100	COG	68pF	±5%	CL10C680JC8NINN#
121	0.90	100	COG	100pF	±5%	CL10C101JC8NINN#
122	0.90	100	COG	150pF	±5%	CL10C151JC8NINN#
123	0.90	100	COG	220pF	±5%	CL10C221JC8NFN#
124	0.90	100	COG	270pF	±5%	CL10C271JC8NINN#
125	0.90	100	COG	330pF	±5%	CL10C331JC8NINN#
126	0.90	100	COG	470pF	±5%	CL10C471JC8NFN#
127	0.90	100	COG	470pF	±5%	CL10C471JC8NINN#
128	0.90	200	COG	220pF	±10%	CL10C221KD8NINN#
129	0.90	200	COG	220pF	±5%	CL10C221JD8NINN#
130	0.90	250	COG	470pF	±5%	CL10C471JE8NFN#
131	0.90	250	COG	470pF	±5%	CL10C471JE8NINN#



# Normal Capacitors\_Standard

Size Code (inch/mm) : 0805/2012

No.	Thickness Max. (mm)	Rated Voltage (Vdc)	TCC	Capacitance	Capacitance Tolerance	Part Number
1	0.75	25	COG	3.9nF	±5%	CL21C392JBANNN#
2	0.75	50	COG	1nF	±5%	CL21C102JBANNN#
3	0.75	50	COG	10pF	±5%	CL21C100JBANFN#
4	0.75	50	COG	11pF	±5%	CL21C110JBANNN#
5	0.75	50	COG	13pF	±5%	CL21C130JBANNN#
6	0.75	50	COG	14pF	±5%	CL21C140JBANNN#
7	0.75	50	COG	15pF	±5%	CL21C150JBANFN#
8	0.75	50	COG	16pF	±5%	CL21C160JBANNN#
9	0.75	50	COG	20pF	±5%	CL21C200JBANNN#
10	0.75	50	COG	22pF	±5%	CL21C220JBANFN#
11	0.75	50	COG	22pF	±5%	CL21C220JBANNN#
12	0.75	50	COG	24pF	±5%	CL21C240JBANNN#
13	0.75	50	COG	25pF	±5%	CL21C250JBANNN#
14	0.75	50	COG	33pF	±5%	CL21C330JBANFN#
15	0.75	50	COG	36pF	±5%	CL21C360JBANNN#
16	0.75	50	COG	39pF	±5%	CL21C390JBANFN#
17	0.75	50	COG	39pF	±5%	CL21C390JBANNN#
18	0.75	50	COG	43pF	±5%	CL21C430JBANNN#
19	0.75	50	COG	47pF	±5%	CL21C470JBANFN#
20	0.75	50	COG	47pF	±5%	CL21C470JBANNN#
21	0.75	50	COG	51pF	±5%	CL21C510JBANNN#
22	0.75	50	COG	62pF	±5%	CL21C620JBANNN#
23	0.75	50	COG	68pF	±5%	CL21C680JBANFN#
24	0.75	50	COG	75pF	±5%	CL21C750JBANNN#
25	0.75	50	COG	91pF	±5%	CL21C910JBANNN#
26	0.75	50	COG	100pF	±10%	CL21C101KBANFN#
27	0.75	50	COG	100pF	±5%	CL21C101JBANFN#
28	0.75	50	COG	100pF	±5%	CL21C101JBANNN#
29	0.75	50	COG	110pF	±5%	CL21C111JBANNN#
30	0.75	50	COG	130pF	±5%	CL21C131JBANNN#
31	0.75	50	COG	150pF	±5%	CL21C151JBANFN#
32	0.75	50	COG	150pF	±5%	CL21C151JBANNN#
33	0.75	50	COG	160pF	±5%	CL21C161JBANNN#
34	0.75	50	COG	180pF	±5%	CL21C181JBANNN#
35	0.75	50	COG	200pF	±5%	CL21C201JBANNN#
36	0.75	50	COG	220pF	±5%	CL21C221JBANFN#
37	0.75	50	COG	220pF	±5%	CL21C221JBANNN#
38	0.75	50	COG	240pF	±5%	CL21C241JBANNN#
39	0.75	50	COG	270pF	±5%	CL21C271JBANFN#
40	0.75	50	COG	270pF	±5%	CL21C271JBANNN#



# Normal Capacitors\_Standard

Size Code (inch/mm) : 0805/2012

No.	Thickness Max. (mm)	Rated Voltage (Vdc)	TCC	Capacitance	Capacitance Tolerance	Part Number
41	0.75	50	COG	300pF	±5%	CL21C301JBANNN#
42	0.75	50	COG	330pF	±5%	CL21C331JBANFN#
43	0.75	50	COG	360pF	±5%	CL21C361JBANNN#
44	0.75	50	COG	390pF	±5%	CL21C391JBANNN#
45	0.75	50	COG	430pF	±5%	CL21C431JBANNN#
46	0.75	50	COG	470pF	±5%	CL21C471JBANFN#
47	0.75	50	COG	510pF	±5%	CL21C511JBANNN#
48	0.75	50	COG	560pF	±5%	CL21C561JBANFN#
49	0.75	50	COG	680pF	±5%	CL21C681JBANNN#
50	0.75	100	COG	1nF	±5%	CL21C102JCANNN#
51	0.75	100	COG	12pF	±5%	CL21C120JCANNN#
52	0.75	100	COG	18pF	±5%	CL21C180JCANNN#
53	0.75	100	COG	27pF	±5%	CL21C270JCANNN#
54	0.75	100	COG	30pF	±5%	CL21C300JCANNN#
55	0.75	100	COG	33pF	±5%	CL21C330JCANFN#
56	0.75	100	COG	47pF	±5%	CL21C470JCANNN#
57	0.75	100	COG	56pF	±5%	CL21C560JCANNN#
58	0.75	100	COG	68pF	±5%	CL21C680JCANNN#
59	0.75	100	COG	100pF	±5%	CL21C101JCANFN#
60	0.75	100	COG	100pF	±5%	CL21C101JCANNN#
61	0.75	100	COG	270pF	±5%	CL21C271JCANNN#
62	0.75	100	COG	330pF	±5%	CL21C331JCANNN#
63	0.95	25	COG	6.8nF	±5%	CL21C682JACNNN#
64	0.95	50	COG	1nF	±5%	CL21C102JBCNFN#
65	0.95	50	COG	12pF	±5%	CL21C120JBCNNN#
66	0.95	50	COG	33pF	±5%	CL21C330JBCNNN#
67	0.95	50	COG	620pF	±5%	CL21C621JBCNNN#
68	0.95	50	COG	680pF	±5%	CL21C681JBCNFN#
69	0.95	50	COG	750pF	±5%	CL21C751JBCNNN#
70	0.95	50	COG	910pF	±5%	CL21C911JBCNNN#
71	0.95	100	COG	470pF	±5%	CL21C471JCCNFN#
72	0.95	100	COG	560pF	±5%	CL21C561JCCNNN#
73	0.95	100	COG	680pF	±5%	CL21C681JCCNNN#
74	0.95	200	COG	18pF	±5%	CL21C180JDCNCN#
75	0.95	200	COG	20pF	±5%	CL21C200JDCNCN#
76	0.95	200	COG	22pF	±5%	CL21C220JDCNCN#
77	0.95	200	COG	24pF	±5%	CL21C240JDCNCN#
78	0.95	200	COG	33pF	±5%	CL21C330JDCNCN#
79	0.95	200	COG	33pF	±5%	CL21C330JDCNNN#
80	0.95	200	COG	36pF	±5%	CL21C360JDCNCN#

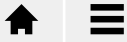

# Normal Capacitors\_Standard

Size Code (inch/mm) : 0805/2012

No.	Thickness Max. (mm)	Rated Voltage (Vdc)	TCC	Capacitance	Capacitance Tolerance	Part Number
81	0.95	200	COG	47pF	±5%	CL21C470JDCN#
82	0.95	200	COG	51pF	±5%	CL21C510JDCN#
83	0.95	200	COG	56pF	±5%	CL21C560JDCN#
84	0.95	200	COG	100pF	±5%	CL21C101JDCN#
85	0.95	200	COG	100pF	±5%	CL21C101JDCFN#
86	0.95	200	COG	100pF	±5%	CL21C101JDCN#
87	0.95	200	COG	120pF	±5%	CL21C121JDCN#
88	0.95	200	COG	150pF	±5%	CL21C151JDCN#
89	0.95	200	COG	220pF	±5%	CL21C221JDCFN#
90	0.95	200	COG	220pF	±5%	CL21C221JDCN#
91	1.35	25	COG	3.3nF	±5%	CL21C332JAFN#
92	1.35	25	COG	4.7nF	±5%	CL21C472JAFN#
93	1.35	25	COG	8.2nF	±5%	CL21C822JAFN#
94	1.35	25	COG	10nF	±5%	CL21C103JAFN#
95	1.35	50	COG	1.2nF	±5%	CL21C122JBFN#
96	1.35	50	COG	1.5nF	±5%	CL21C152JBFN#
97	1.35	50	COG	1.8nF	±5%	CL21C182JBFN#
98	1.35	50	COG	2nF	±5%	CL21C202JBFN#
99	1.35	50	COG	2.2nF	±5%	CL21C222JBFN#
100	1.35	50	COG	2.2nF	±5%	CL21C222JBFN#
101	1.35	50	COG	2.7nF	±5%	CL21C272JBFN#
102	1.35	50	COG	3.9nF	±5%	CL21C392JBFN#
103	1.35	50	COG	4.7nF	±5%	CL21C472JBFN#
104	1.35	50	COG	4.7nF	±5%	CL21C472JBFN#
105	1.35	50	COG	4.7nF	±5%	CL21C472JBFN#
106	1.35	50	COG	5.6nF	±5%	CL21C562JBFN#
107	1.35	50	COG	6.8nF	±5%	CL21C682JBFN#
108	1.35	50	COG	8.2nF	±5%	CL21C822JBFN#
109	1.35	50	COG	10nF	±5%	CL21C103JBFN#
110	1.35	50	COG	10nF	±5%	CL21C103JBFN#
111	1.35	50	COG	15nF	±5%	CL21C153JBFN#
112	1.35	100	COG	1nF	±5%	CL21C102JCFN#
113	1.35	100	COG	2.2nF	±5%	CL21C222JCFN#
114	1.35	100	COG	3.3nF	±5%	CL21C332JCFN#
115	1.35	100	COG	3.9nF	±5%	CL21C392JCFN#
116	1.35	200	COG	1nF	±5%	CL21C102JDFN#
117	1.35	200	COG	1nF	±5%	CL21C102JDFN#
118	1.35	250	COG	1nF	±5%	CL21C102JEFN#
119	1.35	250	COG	1nF	±5%	CL21C102JEFN#
120	1.35	250	COG	2.2nF	±5%	CL21C222JEFN#
121	1.45	250	COG	10nF	±5%	CL21C103JEYNN#



# Normal Capacitors\_Standard

Size Code (inch/mm) : 1206/3216

No.	Thickness Max. (mm)	Rated Voltage (Vdc)	TCC	Capacitance	Capacitance Tolerance	Part Number
1	1.00	50	COG	1.2nF	±5%	CL31C122JBCNNN#
2	1.00	50	COG	1.5nF	±5%	CL31C152JBCNNN#
3	1.00	50	COG	1.8nF	±5%	CL31C182JBCNNN#
4	1.00	50	COG	2.2nF	±5%	CL31C222JBCNNN#
5	1.00	50	COG	10pF	±5%	CL31C100JBCNNN#
6	1.00	50	COG	12pF	±5%	CL31C120JBCNNN#
7	1.00	50	COG	15pF	±5%	CL31C150JBCNNN#
8	1.00	50	COG	18pF	±5%	CL31C180JBCNNN#
9	1.00	50	COG	20pF	±5%	CL31C200JBCNNN#
10	1.00	50	COG	22pF	±5%	CL31C220JBCNNN#
11	1.00	50	COG	27pF	±5%	CL31C270JBCNNN#
12	1.00	50	COG	30pF	±5%	CL31C300JBCNNN#
13	1.00	50	COG	39pF	±5%	CL31C390JBCNNN#
14	1.00	50	COG	51pF	±5%	CL31C510JBCNNN#
15	1.00	50	COG	56pF	±5%	CL31C560JBCNNN#
16	1.00	50	COG	75pF	±5%	CL31C750JBCNNN#
17	1.00	50	COG	82pF	±5%	CL31C820JBCNNN#
18	1.00	50	COG	100pF	±5%	CL31C101JBCNFN#
19	1.00	50	COG	120pF	±5%	CL31C121JBCNNN#
20	1.00	50	COG	180pF	±5%	CL31C181JBCNNN#
21	1.00	50	COG	220pF	±5%	CL31C221JBCNNN#
22	1.00	50	COG	270pF	±5%	CL31C271JBCNNN#
23	1.00	50	COG	330pF	±5%	CL31C331JBCNNN#
24	1.00	50	COG	390pF	±5%	CL31C391JBCNNN#
25	1.00	50	COG	560pF	±5%	CL31C561JBCNNN#
26	1.00	50	COG	680pF	±5%	CL31C681JBCNNN#
27	1.00	50	COG	820pF	±5%	CL31C821JBCNNN#
28	1.00	100	COG	1.5nF	±5%	CL31C152JCCNNN#
29	1.00	100	COG	2.2nF	±5%	CL31C222JCCNNN#
30	1.00	100	COG	20pF	±5%	CL31C200JCCNNN#
31	1.00	100	COG	22pF	±5%	CL31C220JCCNNN#
32	1.00	100	COG	27pF	±5%	CL31C270JCCNNN#
33	1.00	100	COG	47pF	±5%	CL31C470JCCNNN#
34	1.00	100	COG	150pF	±5%	CL31C151JCCNNN#
35	1.00	100	COG	220pF	±5%	CL31C221JCCNNN#



# Normal Capacitors\_Standard

Size Code (inch/mm) : 1206/3216

No.	Thickness Max. (mm)	Rated Voltage (Vdc)	TCC	Capacitance	Capacitance Tolerance	Part Number
36	1.00	100	COG	270pF	±5%	CL31C271JCCNHN#
37	1.00	100	COG	330pF	±5%	CL31C331JCCNHN#
38	1.00	100	COG	470pF	±5%	CL31C471JCCNHN#
39	1.00	100	COG	560pF	±5%	CL31C561JCCNHN#
40	1.00	100	COG	680pF	±5%	CL31C681JCCNHN#
41	1.00	200	COG	220pF	±5%	CL31C221JDCNFN#
42	1.00	200	COG	220pF	±5%	CL31C221JDCNHN#
43	1.30	630	COG	1nF	±5%	CL31C102JHMLNHN#
44	1.40	25	COG	10nF	±5%	CL31C103JAFNHN#
45	1.40	50	COG	3.3nF	±5%	CL31C332JBFNHN#
46	1.40	50	COG	3.9nF	±5%	CL31C392JBFNHN#
47	1.40	50	COG	4.7nF	±5%	CL31C472JBFNHN#
48	1.40	200	COG	1nF	±5%	CL31C102JDFNHN#
49	1.40	500	COG	10pF	±5%	CL31C100JGFNHN#
50	1.40	500	COG	22pF	±5%	CL31C220JGFNHN#
51	1.40	500	COG	33pF	±5%	CL31C330JGFNHN#
52	1.40	500	COG	39pF	±5%	CL31C390JGFNHN#
53	1.40	500	COG	47pF	±5%	CL31C470JGFNHN#
54	1.40	500	COG	47pF	±5%	CL31C470JGFNHN#
55	1.40	500	COG	68pF	±5%	CL31C680JGFNHN#
56	1.40	500	COG	100pF	±5%	CL31C101JGFNHN#
57	1.40	500	COG	100pF	±5%	CL31C101JGFNHN#
58	1.40	500	COG	120pF	±5%	CL31C121JGFNHN#
59	1.40	500	COG	150pF	±5%	CL31C151JGFNHN#
60	1.40	500	COG	180pF	±5%	CL31C181JGFNHN#
61	1.40	500	COG	180pF	±5%	CL31C181JGFNHN#
62	1.40	500	COG	220pF	±5%	CL31C221JGFNHN#
63	1.40	500	COG	220pF	±5%	CL31C221JGFNHN#
64	1.40	500	COG	270pF	±5%	CL31C271JGFNHN#
65	1.40	500	COG	390pF	±5%	CL31C391JGFNHN#
66	1.40	500	COG	390pF	±5%	CL31C391JGFNHN#
67	1.40	500	COG	470pF	±5%	CL31C471JGFNHN#
68	1.40	500	COG	470pF	±5%	CL31C471JGFNHN#
69	1.40	500	COG	560pF	±5%	CL31C561JGFNHN#
70	1.40	500	COG	560pF	±5%	CL31C561JGFNHN#
71	1.40	630	COG	10pF	±5%	CL31C100JHFNHN#
72	1.40	630	COG	10pF	±5%	CL31C100JHFNHN#
73	1.40	630	COG	15pF	±5%	CL31C150JHFNHN#
74	1.40	630	COG	15pF	±5%	CL31C150JHFNHN#
75	1.40	630	COG	22pF	±5%	CL31C220JHFNHN#
76	1.40	630	COG	22pF	±5%	CL31C220JHFNHN#
77	1.40	630	COG	27pF	±5%	CL31C270JHFNHN#
78	1.40	630	COG	33pF	±5%	CL31C330JHFNHN#
79	1.40	630	COG	33pF	±5%	CL31C330JHFNHN#
80	1.40	630	COG	47pF	±5%	CL31C470JHFNHN#



# Normal Capacitors\_Standard

Size Code (inch/mm) : 1206/3216

No.	Thickness Max. (mm)	Rated Voltage (Vdc)	TCC	Capacitance	Capacitance Tolerance	Part Number
81	1.40	630	COG	47pF	±5%	CL31C470JHFNNN#
82	1.40	630	COG	68pF	±5%	CL31C680JHFNNN#
83	1.40	630	COG	100pF	±5%	CL31C101JHFNFN#
84	1.40	630	COG	100pF	±5%	CL31C101JHFNNN#
85	1.40	630	COG	120pF	±5%	CL31C121JHFNNN#
86	1.40	630	COG	150pF	±5%	CL31C151JHFNFN#
87	1.40	630	COG	150pF	±5%	CL31C151JHFNNN#
88	1.40	630	COG	180pF	±5%	CL31C181JHFNNN#
89	1.40	630	COG	220pF	±5%	CL31C221JHFNFN#
90	1.40	630	COG	220pF	±5%	CL31C221JHFNNN#
91	1.40	630	COG	270pF	±5%	CL31C271JHFNNN#
92	1.40	630	COG	330pF	±5%	CL31C331JHFNFN#
93	1.40	630	COG	330pF	±5%	CL31C331JHFNNN#
94	1.40	630	COG	390pF	±5%	CL31C391JHFNNN#
95	1.40	630	COG	470pF	±5%	CL31C471JHFNFN#
96	1.40	630	COG	470pF	±5%	CL31C471JHFNNN#
97	1.40	1000	COG	10pF	±5%	CL31C100JIFNNN#
98	1.40	1000	COG	22pF	±5%	CL31C220JIFNFN#
99	1.40	1000	COG	22pF	±5%	CL31C220JIFNNN#
100	1.40	1000	COG	33pF	±5%	CL31C330JIFNFN#
101	1.40	1000	COG	33pF	±5%	CL31C330JIFNNN#
102	1.40	1000	COG	47pF	±5%	CL31C470JIFNFN#
103	1.40	1000	COG	47pF	±5%	CL31C470JIFNNN#
104	1.40	1000	COG	68pF	±5%	CL31C680JIFNFN#
105	1.40	1000	COG	68pF	±5%	CL31C680JIFNNN#
106	1.40	1000	COG	100pF	±5%	CL31C101JIFNFN#
107	1.40	1000	COG	100pF	±5%	CL31C101JIFNNN#
108	1.40	1000	COG	150pF	±5%	CL31C151JIFNNN#
109	1.80	16	COG	15nF	±5%	CL31C153JOHNNN#
110	1.80	16	COG	120nF	±5%	CL31C124JOHNNN#
111	1.80	25	COG	39nF	±5%	CL31C393JAHNNN#
112	1.80	25	COG	47nF	±5%	CL31C473JAHNNN#
113	1.80	25	COG	100nF	±5%	CL31C104JAHNNN#
114	1.80	50	COG	6.8nF	±5%	CL31C682JBHNNN#
115	1.80	50	COG	22nF	±5%	CL31C223JBHNNN#
116	1.80	50	COG	27nF	±5%	CL31C273JBHNNN#
117	1.80	50	COG	33nF	±5%	CL31C333JBHNNN#
118	1.80	50	COG	47nF	±5%	CL31C473JBHNNN#
119	1.80	100	COG	3.9nF	±5%	CL31C392JCHNNN#
120	1.80	100	COG	10nF	±5%	CL31C103JCHNNN#
121	1.80	100	COG	22nF	±5%	CL31C223JCHNNN#
122	1.80	250	COG	2.2nF	±5%	CL31C222JEHNNN#
123	1.80	250	COG	3.9nF	±5%	CL31C392JEHNNN#
124	1.80	250	COG	4.7nF	±5%	CL31C472JEHNNN#
125	1.80	250	COG	5.6nF	±5%	CL31C562JEHNNN#



# Normal Capacitors\_Standard

Size Code (inch/mm) : 1206/3216

No.	Thickness Max. (mm)	Rated Voltage (Vdc)	TCC	Capacitance	Capacitance Tolerance	Part Number
126	1.80	250	COG	6.8nF	±5%	CL31C682JEHNNN#
127	1.80	250	COG	8.2nF	±5%	CL31C822JEHNNN#
128	1.80	250	COG	22nF	±5%	CL31C223JEHNNN#
129	1.80	500	COG	1nF	±5%	CL31C102JGHNFN#
130	1.80	500	COG	2.2nF	±5%	CL31C222JGHNNN#
131	1.80	500	COG	680pF	±5%	CL31C681JGHNFN#
132	1.80	500	COG	680pF	±5%	CL31C681JGHNNN#
133	1.80	500	COG	820pF	±5%	CL31C821JGHNNN#
134	1.80	630	COG	1nF	±5%	CL31C102JHHNFN#
135	1.80	630	COG	1nF	±5%	CL31C102JHHNNN#
136	1.80	630	COG	1.2nF	±5%	CL31C122JHHNNN#
137	1.80	630	COG	1.5nF	±5%	CL31C152JHHNFN#
138	1.80	630	COG	1.5nF	±5%	CL31C152JHHNNN#
139	1.80	630	COG	1.8nF	±5%	CL31C182JHHNNN#
140	1.80	630	COG	2.2nF	±5%	CL31C222JHHNFN#
141	1.80	630	COG	2.2nF	±5%	CL31C222JHHNNN#
142	1.80	630	COG	2.7nF	±5%	CL31C272JHHNNN#
143	1.80	630	COG	3.3nF	±5%	CL31C332JHHNFN#
144	1.80	630	COG	3.3nF	±5%	CL31C332JHHNNN#
145	1.80	630	COG	10nF	±5%	CL31C103JHHNNN#
146	1.80	630	COG	680pF	±5%	CL31C681JHHNFN#
147	1.80	630	COG	680pF	±5%	CL31C681JHHNNN#
148	1.80	630	COG	820pF	±5%	CL31C821JHHNNN#
149	1.80	1000	COG	1nF	±5%	CL31C102JIHNNN#
150	1.80	1000	COG	180pF	±5%	CL31C181JIHNNN#
151	1.80	1000	COG	220pF	±5%	CL31C221JIHNFN#
152	1.80	1000	COG	220pF	±5%	CL31C221JIHNNN#
153	1.80	1000	COG	270pF	±5%	CL31C271JIHNNN#
154	1.80	1000	COG	330pF	±5%	CL31C331JIHNNN#
155	1.80	1000	COG	470pF	±5%	CL31C471JIHNFN#
156	1.80	1000	COG	470pF	±5%	CL31C471JIHNNN#
157	1.80	2000	COG	15pF	±5%	CL31C150JIHNNN#
158	1.80	2000	COG	47pF	±5%	CL31C470JIHNNN#
159	1.80	2000	COG	100pF	±5%	CL31C101JIHNNN#

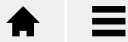

# Normal Capacitors\_Standard

Size Code (inch/mm) : 1210/3225

No.	Thickness Max. (mm)	Rated Voltage (Vdc)	TCC	Capacitance	Capacitance Tolerance	Part Number
1	1.45	25	COG	10nF	±5%	CL32C103JAFNNN#
2	1.45	50	COG	1.8nF	±5%	CL32C182JBFNNN#
3	1.45	50	COG	3.3nF	±5%	CL32C332JBFNNN#
4	1.45	50	COG	4.7nF	±5%	CL32C472JBFNNN#
5	1.45	50	COG	6.8nF	±5%	CL32C682JBFNNN#
6	1.45	500	COG	680pF	±5%	CL32C681JGFNNN#
7	1.45	2000	COG	100pF	±5%	CL32C101JFNNN#
8	1.80	50	COG	11nF	±5%	CL32C113JBHNNN#
9	1.80	50	COG	22nF	±5%	CL32C223JBHNNN#
10	1.80	500	COG	1.8nF	±5%	CL32C182JGHNNN#
11	1.80	630	COG	1.8nF	±5%	CL32C182JHHNNN#
12	2.70	100	COG	33nF	±5%	CL32C333JCJNNN#
13	2.70	100	COG	47nF	±5%	CL32C473JCJNNN#
14	2.70	630	COG	8.2nF	±5%	CL32C822JHJNNN#
15	2.70	630	COG	22nF	±5%	CL32C223JHJNNN#
16	2.70	630	COG	27nF	±5%	CL32C273JHJNNN#
17	2.70	630	COG	33nF	±5%	CL32C333JHJNNN#

## Product Lineup (X5R)

Size Code (inch/mm) : 008004/0201

No.	Thickness Max. (mm)	Rated Voltage (Vdc)	TCC	Capacitance	Capacitance Tolerance	Part Number
1	0.138	6.3	X5R	1nF	±20%	CLR1A102MQ1NINN#
2	0.138	6.3	X5R	10nF	±20%	CLR1A103MQ1NINN#

Size Code (inch/mm) : 01005/0402

No.	Thickness Max. (mm)	Rated Voltage (Vdc)	TCC	Capacitance	Capacitance Tolerance	Part Number
1	0.22	4	X5R	100nF	±20%	CL02A104MR2NINN#
2	0.22	4	X5R	220nF	±20%	CL02A224MR2NINN#
3	0.22	6.3	X5R	100nF	±10%	CL02A104KQ2NINN#
4	0.22	6.3	X5R	100nF	±20%	CL02A104MQ2NINN#
5	0.22	6.3	X5R	10nF	±10%	CL02A103KQ2NINN#
6	0.22	6.3	X5R	1nF	±10%	CL02A102KQ2NINN#
7	0.22	6.3	X5R	2.2nF	±10%	CL02A222KQ2NINN#
8	0.22	6.3	X5R	220nF	±20%	CL02A224MQ2NINN#
9	0.22	6.3	X5R	470nF	±20%	CL02A474MQ2NINN#
10	0.22	10	X5R	10nF	±10%	CL02A103KP2NINN#
11	0.22	10	X5R	1nF	±10%	CL02A102KP2NINN#
12	0.25	6.3	X5R	1uF	±20%	CL02A105MQ2NQN#
13	0.25	6.3	X5R	470nF	±20%	CL02A474MQ2NQN#

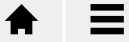

# Normal Capacitors\_Standard

Size Code (inch/mm) : 015008/0502

No.	Thickness Max. (mm)	Rated Voltage (Vdc)	TCC	Capacitance	Capacitance Tolerance	Part Number
1	0.275	6.3	X5R	1uF	±20%	CLR5A105MQ2CNN#

Size Code (inch/mm) : 0201/0603

No.	Thickness Max. (mm)	Rated Voltage (Vdc)	TCC	Capacitance	Capacitance Tolerance	Part Number
1	0.33	6.3	X5R	1uF	±20%	CL03A105MQ3CNN#
2	0.33	6.3	X5R	15nF	±10%	CL03A153KQ3NNN#
3	0.33	6.3	X5R	22nF	±10%	CL03A223KQ3NNN#
4	0.33	6.3	X5R	47nF	±10%	CL03A473KQ3NNN#
5	0.33	6.3	X5R	68nF	±10%	CL03A683KQ3NNN#
6	0.33	6.3	X5R	100nF	±10%	CL03A104KQ3NNN#
7	0.33	6.3	X5R	100nF	±20%	CL03A104MQ3NNN#
8	0.33	6.3	X5R	220nF	±10%	CL03A224KQ3NNN#
9	0.33	6.3	X5R	220nF	±20%	CL03A224MQ3NNN#
10	0.33	6.3	X5R	470nF	±10%	CL03A474KQ3NNN#
11	0.33	6.3	X5R	470nF	±10%	CL03A474KQ3ZNN#
12	0.33	6.3	X5R	470nF	±20%	CL03A474MQ3NNN#
13	0.33	10	X5R	2.2nF	±10%	CL03A222KP3NNN#
14	0.33	10	X5R	4.7nF	±10%	CL03A472KP3NNN#
15	0.33	10	X5R	10nF	±10%	CL03A103KP3NNN#
16	0.33	10	X5R	47nF	±10%	CL03A473KP3NNN#
17	0.33	10	X5R	100nF	±10%	CL03A104KP3NNN#
18	0.33	10	X5R	100nF	±20%	CL03A104MP3NNN#
19	0.33	10	X5R	220nF	±10%	CL03A224KP3NNN#
20	0.33	10	X5R	470nF	±10%	CL03A474KP3NNN#
21	0.33	16	X5R	100nF	±10%	CL03A104KQ3NNN#
22	0.33	16	X5R	100nF	±20%	CL03A104MQ3NNN#
23	0.33	25	X5R	4.7nF	±10%	CL03A472KA3NNN#
24	0.33	25	X5R	10nF	±10%	CL03A103KA3NNN#
25	0.33	25	X5R	22nF	±10%	CL03A223KA3NNN#
26	0.33	25	X5R	100nF	±10%	CL03A104KA3NNN#
27	0.33	25	X5R	100nF	±20%	CL03A104MA3NNN#
28	0.33	35	X5R	100nF	±10%	CL03A104KL3NNN#
29	0.35	4	X5R	1uF	±20%	CL03A105MR3CSN#
30	0.35	6.3	X5R	1uF	±10%	CL03A105KQ3CSN#
31	0.35	6.3	X5R	1uF	±20%	CL03A105MQ3CSN#
32	0.35	6.3	X5R	1uF	±20%	CL03A105MQ3ISN#
33	0.35	6.3	X5R	1uF	±20%	CL03A105MQ3NSN#
34	0.35	6.3	X5R	2.2uF	±20%	CL03A225MQ3CSN#
35	0.35	10	X5R	1uF	±10%	CL03A105KP3NSN#
36	0.35	10	X5R	1uF	±20%	CL03A105MP3ISN#
37	0.35	10	X5R	1uF	±20%	CL03A105MP3NSN#
38	0.39	4	X5R	3.7uF	±20%	CL03A375MR3DRN#
39	0.39	6.3	X5R	1uF	±20%	CL03A105MQ3DRN#
40	0.39	6.3	X5R	1.9uF	±20%	CL03A195MQ3DRN#

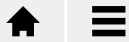

# Normal Capacitors\_Standard

Size Code (inch/mm) : 0201/0603

No.	Thickness Max. (mm)	Rated Voltage (Vdc)	TCC	Capacitance	Capacitance Tolerance	Part Number
41	0.39	6.3	X5R	2.2uF	±20%	CL03A225MQ3CR6#
42	0.39	6.3	X5R	2.2uF	±20%	CL03A225MQ3CRN#
43	0.39	6.3	X5R	2.2uF	±20%	CL03A225MQ3IRN#
44	0.39	6.3	X5R	3uF	±20%	CL03A305MQ3CRN#
45	0.39	6.3	X5R	3.9uF	±20%	CL03A395MQ3CRN#
46	0.39	6.3	X5R	4.7uF	±20%	CL03A475MQ3CRN#
47	0.39	10	X5R	2.2uF	±10%	CL03A225KP3CRN#
48	0.39	10	X5R	2.2uF	±20%	CL03A225MP3CRN#
49	0.39	10	X5R	2.2uF	±20%	CL03A225MP3IRN#
50	0.39	10	X5R	330nF	±10%	CL03A334KP3ZRN#
51	0.39	16	X5R	1uF	±20%	CL03A105MO3IRN#
52	0.39	16	X5R	1uF	±20%	CL03A105MO3NRN#
53	0.39	25	X5R	220nF	±10%	CL03A224KA3NRN#
54	0.39	25	X5R	220nF	±10%	CL03A224KA3ZRN#
55	0.39	25	X5R	330nF	±10%	CL03A334KA3NRN#
56	0.39	25	X5R	330nF	±10%	CL03A334KA3ZRN#
57	0.39	35	X5R	220nF	±10%	CL03A224KL3NRN#
58	0.55	4	X5R	4.9uF	±20%	CL03A495MR5D65#
59	0.55	6.3	X5R	4.7uF	±20%	CL03A475MQ5C65#
60	0.55	6.3	X5R	4.7uF	±20%	CL03A475MQ5D65#
61	0.55	16	X5R	2.2uF	±20%	CL03A225MO5C65#

Size Code (inch/mm) : 0402/1005

No.	Thickness Max. (mm)	Rated Voltage (Vdc)	TCC	Capacitance	Capacitance Tolerance	Part Number
1	0.33	6.3	X5R	1uF	±10%	CL05A105KQ3LNN#
2	0.33	6.3	X5R	2.2uF	±20%	CL05A225MQ3LRN#
3	0.33	6.3	X5R	4.7uF	±20%	CL05A475MQ3JUD#
4	0.35	6.3	X5R	4.7uF	±20%	CL05A475MQ3LUN#
5	0.50	6.3	X5R	10uF	±20%	CL05A106MQ4N68#
6	0.50	10	X5R	10uF	±20%	CL05A106MP5C64#
7	0.55	4	X5R	2.2uF	±20%	CL05A225MR5NINN#
8	0.55	6.3	X5R	1uF	±10%	CL05A105KQ5NINN#
9	0.55	6.3	X5R	1uF	±20%	CL05A105MQ5NINN#
10	0.55	6.3	X5R	1uF	±5%	CL05A105JQ5NINN#
11	0.55	6.3	X5R	2.2uF	±10%	CL05A225KQ5NINN#
12	0.55	6.3	X5R	2.2uF	±20%	CL05A225MQ5NINN#
13	0.55	6.3	X5R	100nF	±10%	CL05A104KQ5NINN#
14	0.55	6.3	X5R	220nF	±10%	CL05A224KQ5NINN#
15	0.55	6.3	X5R	330nF	±10%	CL05A334KQ5NINN#
16	0.55	6.3	X5R	330nF	±20%	CL05A334MQ5NINN#
17	0.55	6.3	X5R	470nF	±10%	CL05A474KQ5NINN#
18	0.55	10	X5R	1uF	±10%	CL05A105KP5NFN#
19	0.55	10	X5R	1uF	±10%	CL05A105KP5NINN#
20	0.55	10	X5R	2.2uF	±10%	CL05A225KP5NINN#



# Normal Capacitors\_Standard

Size Code (inch/mm) : 0402/1005

No.	Thickness Max. (mm)	Rated Voltage (Vdc)	TCC	Capacitance	Capacitance Tolerance	Part Number
21	0.55	10	X5R	2.2uF	±20%	CL05A225MP5NNN#
22	0.55	10	X5R	100nF	±10%	CL05A104KP5NNN#
23	0.55	10	X5R	150nF	±10%	CL05A154KP5NNN#
24	0.55	10	X5R	220nF	±10%	CL05A224KP5NNN#
25	0.55	10	X5R	220nF	±20%	CL05A224MP5NNN#
26	0.55	10	X5R	470nF	±10%	CL05A474KP5NNN#
27	0.55	16	X5R	1uF	±10%	CL05A105K05NFN#
28	0.55	16	X5R	1uF	±10%	CL05A105K05NNN#
29	0.55	16	X5R	4.2uF	±10%	CL05A425K05LUN#
30	0.55	16	X5R	4.7uF	±20%	CL05A475M05LUN#
31	0.55	16	X5R	100nF	±10%	CL05A104K05NNN#
32	0.55	16	X5R	100nF	±20%	CL05A104M05NNN#
33	0.55	16	X5R	100nF	±5%	CL05A104J05NNN#
34	0.55	16	X5R	220nF	±10%	CL05A224K05NNN#
35	0.55	16	X5R	470nF	±10%	CL05A474K05NNN#
36	0.55	25	X5R	1uF	±10%	CL05A105KA5NNN#
37	0.55	25	X5R	2.2uF	±20%	CL05A225MA5JUN#
38	0.55	25	X5R	100nF	±10%	CL05A104KA5NFN#
39	0.55	25	X5R	100nF	±10%	CL05A104KA5NNN#
40	0.55	25	X5R	220nF	±10%	CL05A224KA5NNN#
41	0.55	25	X5R	330nF	±10%	CL05A334KA5NNN#
42	0.55	25	X5R	470nF	±10%	CL05A474KA5NNN#
43	0.57	6.3	X5R	2.2uF	±10%	CL05A225KQ5NSN#
44	0.57	6.3	X5R	2.2uF	±20%	CL05A225MQ5NSN#
45	0.57	6.3	X5R	2.2uF	±20%	CL05A225MQ5ZSN#
46	0.57	10	X5R	2.2uF	±10%	CL05A225KP5NSN#
47	0.57	10	X5R	2.2uF	±20%	CL05A225MP5NSN#
48	0.60	4	X5R	4.7uF	±20%	CL05A475MR5NQN#
49	0.60	16	X5R	2.2uF	±10%	CL05A225K05NQN#
50	0.60	16	X5R	2.2uF	±20%	CL05A225M05NQN#
51	0.60	25	X5R	1uF	±10%	CL05A105KA5NFQ#
52	0.60	25	X5R	1uF	±10%	CL05A105KA5NQN#
53	0.65	4	X5R	18uF	±20%	CL05A186MR5DRN#
54	0.65	4	X5R	20uF	±20%	CL05A206MR5DRN#
55	0.65	6.3	X5R	4.7uF	±10%	CL05A475KQ5NRRN#
56	0.65	6.3	X5R	4.7uF	±20%	CL05A475MQ5NRRN#
57	0.65	6.3	X5R	6uF	±20%	CL05A605MQ5DRN#
58	0.65	6.3	X5R	9uF	±20%	CL05A905MQ5DRN#
59	0.65	6.3	X5R	10uF	±20%	CL05A106MQ5NRRN#
60	0.65	6.3	X5R	15uF	±20%	CL05A156MQ5Z64#
61	0.65	10	X5R	4.7uF	±10%	CL05A475KP5NRRN#
62	0.65	10	X5R	4.7uF	±20%	CL05A475MP5NRRN#
63	0.65	10	X5R	10uF	±20%	CL05A106MP5Z64#
64	0.65	35	X5R	1uF	±10%	CL05A105KL5NRRN#
65	0.70	4	X5R	10uF	±20%	CL05A106MR5NUN#



# Normal Capacitors\_Standard

Size Code (inch/mm) : 0402/1005

No.	Thickness Max. (mm)	Rated Voltage (Vdc)	TCC	Capacitance	Capacitance Tolerance	Part Number
66	0.70	4	X5R	22uF	±20%	CL05A226MR5QUN#
67	0.70	4	X5R	23uF	±20%	CL05A236MR5DUN#
68	0.70	6.3	X5R	10uF	±20%	CL05A106MQ5NUN#
69	0.70	6.3	X5R	22uF	±20%	CL05A226MQ5CUN#
70	0.70	10	X5R	4.7uF	±20%	CL05A475MP5NUN#
71	0.70	10	X5R	10uF	±20%	CL05A106MP5IUN#
72	0.70	16	X5R	4.7uF	±20%	CL05A475M05NUN#
73	0.70	25	X5R	2.2uF	±10%	CL05A225KA5NUN#
74	0.70	25	X5R	2.2uF	±20%	CL05A225MA5NUN#
75	0.70	25	X5R	4.7uF	±20%	CL05A475MA5NUN#
76	0.70	35	X5R	2.2uF	±20%	CL05A225ML5NUN#
77	0.80	4	X5R	27uF	±20%	CL05A276MR6DUN#
78	0.80	10	X5R	10uF	±20%	CL05A106MP68UN#
79	0.80	10	X5R	10uF	±20%	CL05A106MP6NUN#
80	1.00	6.3	X5R	10uF	±20%	CL05A106MQ5N3U#

Size Code (inch/mm) : 0603/1608

No.	Thickness Max. (mm)	Rated Voltage (Vdc)	TCC	Capacitance	Capacitance Tolerance	Part Number
1	0.50	6.3	X5R	2.2uF	±10%	CL10A225KQ5LNN#
2	0.50	6.3	X5R	4.7uF	±10%	CL10A475KQ5LNN#
3	0.50	10	X5R	2.2uF	±10%	CL10A225KP5LNN#
4	0.50	10	X5R	4.7uF	±10%	CL10A475KP5LNN#
5	0.50	16	X5R	2.2uF	±10%	CL10A225KQ5LNN#
6	0.50	25	X5R	2.2uF	±10%	CL10A225KA5LNN#
7	0.65	16	X5R	10uF	±20%	CL10A106MOAFZN#
8	0.65	25	X5R	10uF	±20%	CL10A106MAAFZN#
9	0.65	25	X5R	10uF	±20%	CL10A106MAAIZN#
10	0.65	35	X5R	4.7uF	±10%	CL10A475KLAFZN#
11	0.80	6.3	X5R	22uF	±20%	CL10A226MQ7LUN#
12	0.80	10	X5R	22uF	±20%	CL10A226MP7LUN#
13	0.80	16	X5R	22uF	±20%	CL10A226MO79ZLN#
14	0.80	16	X5R	22uF	±20%	CL10A226MO7FZLN#
15	0.80	16	X5R	22uF	±20%	CL10A226MO7JZLN#
16	0.90	6.3	X5R	1uF	±10%	CL10A105KQ8N3N#
17	0.90	6.3	X5R	2.2uF	±10%	CL10A225KQ8N3N#
18	0.90	6.3	X5R	2.2uF	±10%	CL10A225KQ8N3N#
19	0.90	6.3	X5R	4.7uF	±10%	CL10A475KQ8N3N#
20	0.90	6.3	X5R	4.7uF	±10%	CL10A475KQ8N3N#
21	0.90	6.3	X5R	4.7uF	±20%	CL10A475MQ8N3N#
22	0.90	6.3	X5R	10uF	±10%	CL10A106KQ8N3N#
23	0.90	6.3	X5R	10uF	±20%	CL10A106MQ8N3N#
24	0.90	6.3	X5R	22uF	±20%	CL10A226MQ7NRN#
25	0.90	10	X5R	1uF	±10%	CL10A105KP8N3N#



# Normal Capacitors\_Standard

Size Code (inch/mm) : 0603/1608

No.	Thickness Max. (mm)	Rated Voltage (Vdc)	TCC	Capacitance	Capacitance Tolerance	Part Number
26	0.90	10	X5R	2.2uF	±10%	CL10A225KP8NINN#
27	0.90	10	X5R	2.2uF	±20%	CL10A225MP8NINN#
28	0.90	10	X5R	3.3uF	±10%	CL10A335KP8NFN#
29	0.90	10	X5R	3.3uF	±10%	CL10A335KP8NINN#
30	0.90	10	X5R	4.7uF	±10%	CL10A475KP8NFN#
31	0.90	10	X5R	4.7uF	±10%	CL10A475KP8NINN#
32	0.90	10	X5R	10uF	±10%	CL10A106KP8NFN#
33	0.90	10	X5R	10uF	±10%	CL10A106KP8NINN#
34	0.90	10	X5R	10uF	±20%	CL10A106MP8NFN#
35	0.90	10	X5R	220nF	±10%	CL10A224KP8NINN#
36	0.90	16	X5R	1uF	±10%	CL10A105K08NINN#
37	0.90	16	X5R	1uF	±20%	CL10A105M08NINN#
38	0.90	16	X5R	2.2uF	±10%	CL10A225K08N3N#
39	0.90	16	X5R	2.2uF	±10%	CL10A225K08NFN#
40	0.90	16	X5R	2.2uF	±10%	CL10A225K08NINN#
41	0.90	16	X5R	4.7uF	±10%	CL10A475K08NFN#
42	0.90	16	X5R	4.7uF	±20%	CL10A475M08NINN#
43	0.90	16	X5R	470nF	±10%	CL10A474K08NINN#
44	0.90	25	X5R	1uF	±10%	CL10A105KA8NFN#
45	0.90	25	X5R	1uF	±10%	CL10A105KA8NINN#
46	0.90	25	X5R	2.2uF	±10%	CL10A225KA8NINN#
47	0.90	25	X5R	100nF	±10%	CL10A104KA8NINN#
48	0.90	25	X5R	470nF	±10%	CL10A474KA8NINN#
49	0.90	35	X5R	1uF	±10%	CL10A105KL8NINN#
50	0.90	35	X5R	2.2uF	±10%	CL10A225KL8NINN#
51	0.90	50	X5R	1uF	±10%	CL10A105KB8NINN#
52	0.90	50	X5R	1uF	±20%	CL10A105MB8NINN#
53	0.90	50	X5R	220nF	±10%	CL10A224KB8NINN#
54	0.90	50	X5R	470nF	±10%	CL10A474KB8NINN#
55	0.95	6.3	X5R	10uF	±20%	CL10A106MQ8NQN#
56	0.95	10	X5R	10uF	±20%	CL10A106MP8NFS#
57	0.95	16	X5R	4.7uF	±10%	CL10A475K08NQN#
58	0.95	16	X5R	10uF	±10%	CL10A106K08NQN#
59	0.95	25	X5R	4.7uF	±10%	CL10A475KA8NQN#
60	0.95	25	X5R	4.7uF	±20%	CL10A475MA8NQN#
61	1.00	4	X5R	47uF	±20%	CL10A476MR8NRN#
62	1.00	6.3	X5R	22uF	±10%	CL10A226KQ8NRN#
63	1.00	6.3	X5R	22uF	±20%	CL10A226MQ8N3R#
64	1.00	6.3	X5R	22uF	±20%	CL10A226MQ8NFR#
65	1.00	6.3	X5R	22uF	±20%	CL10A226MQ8NRN#
66	1.00	6.3	X5R	22uF	±20%	CL10A226MQ8QRN#
67	1.00	6.3	X5R	47uF	±20%	CL10A476MQ8Q3R#
68	1.00	6.3	X5R	47uF	±20%	CL10A476MQ8QRN#
69	1.00	10	X5R	22uF	±20%	CL10A226MP8NRN#
70	1.00	25	X5R	10uF	±20%	CL10A106MA8IRN#

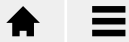

# Normal Capacitors\_Standard

Size Code (inch/mm) : 0603/1608

No.	Thickness Max. (mm)	Rated Voltage (Vdc)	TCC	Capacitance	Capacitance Tolerance	Part Number
71	1.00	25	X5R	10uF	±20%	CL10A106MA8NRN#
72	1.00	25	X5R	10uF	±20%	CL10A106MA8ZRN#
73	1.00	35	X5R	4.7uF	±10%	CL10A475KL8NRN#
74	1.00	35	X5R	10uF	±20%	CL10A106ML8NRN#
75	1.00	50	X5R	4.7uF	±10%	CL10A475KB86RN#
76	1.05	6.3	X5R	22uF	±20%	CL10A226MQ8NUN#
77	1.05	10	X5R	22uF	±20%	CL10A226MP8NUN#
78	1.10	4	X5R	47uF	±20%	CL10A476MR8NZN#

Size Code (inch/mm) : 0805/2012

No.	Thickness Max. (mm)	Rated Voltage (Vdc)	TCC	Capacitance	Capacitance Tolerance	Part Number
1	0.80	6.3	X5R	47uF	±20%	CL21A476MQ7LRN#
2	0.80	10	X5R	10uF	±10%	CL21A106KP7LQN#
3	0.80	25	X5R	22uF	±20%	CL21A226MA7FUN#
4	0.90	6.3	X5R	47uF	±20%	CL21A476MQ8LRN#
5	0.95	6.3	X5R	4.7uF	±10%	CL21A475KQCLNN#
6	0.95	6.3	X5R	10uF	±10%	CL21A106KQCLNN#
7	0.95	6.3	X5R	10uF	±10%	CL21A106KQCLRN#
8	0.95	6.3	X5R	10uF	±20%	CL21A106MQCLNN#
9	0.95	6.3	X5R	22uF	±10%	CL21A226KQCLRN#
10	0.95	6.3	X5R	22uF	±20%	CL21A226MQCLRN#
11	0.95	6.3	X5R	47uF	±20%	CL21A476MQCLRN#
12	0.95	10	X5R	2.2uF	±10%	CL21A225KPCLNN#
13	0.95	10	X5R	4.7uF	±10%	CL21A475KPCLNN#
14	0.95	10	X5R	10uF	±10%	CL21A106KPCLQN#
15	0.95	10	X5R	10uF	±10%	CL21A106KPCLRN#
16	0.95	10	X5R	22uF	±10%	CL21A226KPCLRN#
17	0.95	10	X5R	22uF	±20%	CL21A226MPCLRN#
18	0.95	16	X5R	1uF	±10%	CL21A105KOCLNN#
19	0.95	16	X5R	2.2uF	±10%	CL21A225KOCLNN#
20	0.95	16	X5R	4.7uF	±10%	CL21A475KOCLRN#
21	0.95	16	X5R	10uF	±10%	CL21A106KOCL3R#
22	0.95	16	X5R	10uF	±10%	CL21A106KOCLRN#
23	0.95	16	X5R	22uF	±20%	CL21A226MOCLRN#
24	0.95	25	X5R	1uF	±10%	CL21A105KACLNN#
25	0.95	25	X5R	2.2uF	±10%	CL21A225KACLNN#
26	0.95	25	X5R	4.7uF	±10%	CL21A475KACLRN#
27	0.95	25	X5R	10uF	±10%	CL21A106KACLRN#
28	0.95	35	X5R	4.7uF	±10%	CL21A475KLCLQN#
29	0.95	50	X5R	1uF	±10%	CL21A105KBCLNN#
30	1.00	6.3	X5R	47uF	±20%	CL21A476MQ9LRN#
31	1.00	50	X5R	2.2uF	±10%	CL21A225KB9LNN#
32	1.20	6.3	X5R	33uF	±20%	CL21A336MQELRN#
33	1.35	6.3	X5R	4.7uF	±10%	CL21A475KQFNNN#
34	1.35	6.3	X5R	4.7uF	±20%	CL21A475MQFNNN#
35	1.35	6.3	X5R	10uF	±10%	CL21A106KQFNFN#



# Normal Capacitors\_Standard

Size Code (inch/mm) : 0805/2012

No.	Thickness Max. (mm)	Rated Voltage (Vdc)	TCC	Capacitance	Capacitance Tolerance	Part Number
36	1.35	6.3	X5R	10uF	±10%	CL21A106KQFNNN#
37	1.35	6.3	X5R	10uF	±20%	CL21A106MQFNNN#
38	1.35	10	X5R	1uF	±10%	CL21A105KPFNNN#
39	1.35	10	X5R	2.2uF	±10%	CL21A225KPFNNN#
40	1.35	10	X5R	3.3uF	±10%	CL21A335KPFNNN#
41	1.35	10	X5R	4.7uF	±10%	CL21A475KPFNNN#
42	1.35	10	X5R	4.7uF	±20%	CL21A475MPFNNN#
43	1.35	10	X5R	10uF	±10%	CL21A106KPFNNN#
44	1.35	10	X5R	10uF	±20%	CL21A106MPFNNN#
45	1.35	16	X5R	2.2uF	±10%	CL21A225KOFNNN#
46	1.35	16	X5R	4.7uF	±10%	CL21A475KOFNNN#
47	1.35	16	X5R	10uF	±10%	CL21A106KOFNNN#
48	1.35	16	X5R	10uF	±20%	CL21A106MOFNNN#
49	1.35	25	X5R	2.2uF	±10%	CL21A225KAFNFN#
50	1.35	25	X5R	2.2uF	±10%	CL21A225KAFNNN#
51	1.35	25	X5R	4.7uF	±20%	CL21A475MAFNNN#
52	1.35	25	X5R	10uF	±10%	CL21A106KAFN3N#
53	1.35	50	X5R	2.2uF	±10%	CL21A225KBFNNN#
54	1.40	6.3	X5R	10uF	±20%	CL21A106MQQNNN#
55	1.40	6.3	X5R	22uF	±10%	CL21A226KQQNFN#
56	1.40	6.3	X5R	22uF	±10%	CL21A226KQQNNN#
57	1.40	6.3	X5R	22uF	±20%	CL21A226MQQN3N#
58	1.40	6.3	X5R	22uF	±20%	CL21A226MQQNNN#
59	1.40	10	X5R	22uF	±20%	CL21A226MPQNNN#
60	1.40	16	X5R	10uF	±10%	CL21A106KQQNFN#
61	1.40	16	X5R	10uF	±10%	CL21A106KQQNNN#
62	1.40	25	X5R	4.7uF	±10%	CL21A475KAQN3N#
63	1.40	25	X5R	4.7uF	±10%	CL21A475KAQNFN#
64	1.40	25	X5R	4.7uF	±10%	CL21A475KAQNNN#
65	1.40	25	X5R	4.7uF	±20%	CL21A475MAQNNN#
66	1.40	25	X5R	22uF	±20%	CL21A226MAQNFN#
67	1.40	50	X5R	2.2uF	±10%	CL21A225KBQNNN#
68	1.40	50	X5R	4.7uF	±10%	CL21A475KBQNNN#
69	1.45	4	X5R	47uF	±20%	CL21A476MRYNNN#
70	1.45	4	X5R	100uF	±20%	CL21A107MRYNNN#
71	1.45	6.3	X5R	47uF	±20%	CL21A476MQYN3N#
72	1.45	6.3	X5R	47uF	±20%	CL21A476MQYNNN#
73	1.45	16	X5R	22uF	±20%	CL21A226MOYNNN#
74	1.45	25	X5R	10uF	±10%	CL21A106KAYN3N#
75	1.45	25	X5R	10uF	±10%	CL21A106KAYNFN#
76	1.45	25	X5R	10uF	±10%	CL21A106KAYNNN#
77	1.45	25	X5R	10uF	±20%	CL21A106MAYNNN#
78	1.45	25	X5R	22uF	±20%	CL21A226MAYNNN#
79	1.45	50	X5R	10uF	±10%	CL21A106KBYQNN#



# Normal Capacitors\_Standard

Size Code (inch/mm) : 1206/3216

No.	Thickness Max. (mm)	Rated Voltage (Vdc)	TCC	Capacitance	Capacitance Tolerance	Part Number
1	0.95	16	X5R	3.3uF	±10%	CL31A335KOC LNN#
2	0.95	16	X5R	4.7uF	±10%	CL31A475KOC LNN#
3	0.95	16	X5R	10uF	±10%	CL31A106KOC LNN#
4	0.95	16	X5R	22uF	±10%	CL31A226KOC LFN#
5	0.95	16	X5R	22uF	±10%	CL31A226KOC LNN#
6	0.95	16	X5R	22uF	±20%	CL31A226MOC LFN#
7	0.95	16	X5R	22uF	±20%	CL31A226MOC LNN#
8	0.95	25	X5R	4.7uF	±10%	CL31A475KAC LNN#
9	0.95	25	X5R	10uF	±10%	CL31A106KAC LNN#
10	1.00	35	X5R	4.7uF	±10%	CL31A475KL9 LNN#
11	1.00	50	X5R	1uF	±10%	CL31A105KB9 LNN#
12	1.00	50	X5R	2.2uF	±10%	CL31A225KB9 LNN#
13	1.00	50	X5R	4.7uF	±10%	CL31A475KB9 LNN#
14	1.00	100	X5R	2.2uF	±10%	CL31A225KC9 LNN#
15	1.25	10	X5R	10uF	±10%	CL31A106KP LNN#
16	1.80	6.3	X5R	10uF	±10%	CL31A106KQH NNN#
17	1.80	6.3	X5R	10uF	±20%	CL31A106MQH NNN#
18	1.80	6.3	X5R	22uF	±10%	CL31A226KQH NNN#
19	1.80	6.3	X5R	22uF	±20%	CL31A226MQH NNN#
20	1.80	6.3	X5R	47uF	±10%	CL31A476KQH NNN#
21	1.80	6.3	X5R	47uF	±20%	CL31A476MQH NNN#
22	1.80	6.3	X5R	100uF	±20%	CL31A107MQH NNN#
23	1.80	10	X5R	10uF	±10%	CL31A106KPH NNN#
24	1.80	10	X5R	22uF	±10%	CL31A226KPH NNN#
25	1.80	10	X5R	22uF	±20%	CL31A226MPH NNN#
26	1.80	10	X5R	47uF	±20%	CL31A476MPH NFN#
27	1.80	10	X5R	47uF	±20%	CL31A476MPH NNN#
28	1.80	16	X5R	2.2uF	±10%	CL31A225KOH NNN#
29	1.80	16	X5R	3.3uF	±10%	CL31A335KOH NNN#
30	1.80	16	X5R	4.7uF	±10%	CL31A475KOH NNN#
31	1.80	16	X5R	4.7uF	±20%	CL31A475MOH NNN#
32	1.80	16	X5R	10uF	±10%	CL31A106KOH NNN#
33	1.80	16	X5R	10uF	±20%	CL31A106MOH NNN#
34	1.80	16	X5R	22uF	±10%	CL31A226KOH NFN#
35	1.80	16	X5R	22uF	±10%	CL31A226KOH NNN#
36	1.80	16	X5R	22uF	±20%	CL31A226MOH NNN#
37	1.80	25	X5R	3.3uF	±10%	CL31A335KAH NNN#
38	1.80	25	X5R	4.7uF	±10%	CL31A475KAH NNN#
39	1.80	25	X5R	10uF	±10%	CL31A106KAH NFN#
40	1.80	25	X5R	10uF	±10%	CL31A106KAH NNN#
41	1.80	25	X5R	10uF	±20%	CL31A106MAH NNN#
42	1.80	25	X5R	22uF	±10%	CL31A226KAH NNN#
43	1.80	25	X5R	22uF	±20%	CL31A226MAH NNN#
44	1.80	50	X5R	4.7uF	±10%	CL31A475KBH NNN#
45	1.80	50	X5R	10uF	±10%	CL31A106KBH NNN#
46	1.80	50	X5R	10uF	±20%	CL31A106MBH NNN#
47	1.90	6.3	X5R	100uF	±20%	CL31A107MQK NNN#



# Normal Capacitors\_Standard

Size Code (inch/mm) : 1210/3225

No.	Thickness Max. (mm)	Rated Voltage (Vdc)	TCC	Capacitance	Capacitance Tolerance	Part Number
1	0.95	16	X5R	10uF	±10%	CL32A106KOCLNN#
2	0.95	16	X5R	22uF	±20%	CL32A226MOCLNN#
3	1.70	16	X5R	22uF	±10%	CL32A226KOTFNN#
4	1.70	16	X5R	22uF	±20%	CL32A226MOTLNN#
5	1.70	25	X5R	10uF	±10%	CL32A106KATLNN#
6	2.00	25	X5R	10uF	±10%	CL32A106KAULNN#
7	2.00	35	X5R	4.7uF	±10%	CL32A475KLULNN#
8	2.00	35	X5R	10uF	±10%	CL32A106KLULNN#
9	2.20	10	X5R	10uF	±10%	CL32A106KPINNN#
10	2.70	6.3	X5R	22uF	±10%	CL32A226KQJNNN#
11	2.70	6.3	X5R	22uF	±20%	CL32A226MQJNNN#
12	2.70	6.3	X5R	47uF	±10%	CL32A476KQJNNN#
13	2.70	6.3	X5R	47uF	±20%	CL32A476MQJNNN#
14	2.70	10	X5R	22uF	±10%	CL32A226KPJNNN#
15	2.70	10	X5R	22uF	±20%	CL32A226MPJNNN#
16	2.70	10	X5R	47uF	±10%	CL32A476KPJNNN#
17	2.70	16	X5R	10uF	±10%	CL32A106KOJNNN#
18	2.70	16	X5R	10uF	±20%	CL32A106MOJNNN#
19	2.70	16	X5R	22uF	±10%	CL32A226KOJNFN#
20	2.70	16	X5R	22uF	±10%	CL32A226KOJNNN#
21	2.70	16	X5R	22uF	±20%	CL32A226MOJNNN#
22	2.70	16	X5R	47uF	±10%	CL32A476KOJNNN#
23	2.70	16	X5R	47uF	±20%	CL32A476MOJNNN#
24	2.70	25	X5R	10uF	±10%	CL32A106KAJNNN#
25	2.70	25	X5R	22uF	±10%	CL32A226KAJNFN#
26	2.70	25	X5R	22uF	±10%	CL32A226KAJNNN#
27	2.70	25	X5R	22uF	±20%	CL32A226MAJNNN#
28	2.70	50	X5R	10uF	±10%	CL32A106KBJNNN#
29	2.70	50	X5R	10uF	±20%	CL32A106MBJNNN#
30	2.80	6.3	X5R	100uF	±20%	CL32A107MQVNNN#
31	2.80	6.3	X5R	150uF	±20%	CL32A157MQVNNN#
32	2.80	6.3	X5R	220uF	±20%	CL32A227MQVNNN#
33	2.80	10	X5R	100uF	±20%	CL32A107MPVNNN#



# Normal Capacitors\_Standard

## Product Lineup (X6S)

Size Code (inch/mm) : 01005/0402

No.	Thickness Max. (mm)	Rated Voltage (Vdc)	TCC	Capacitance	Capacitance Tolerance	Part Number
1	0.22	4	X6S	100nF	±20%	CL02X104MR2NHN#
2	0.22	4	X6S	470nF	±20%	CL02X474MR2NHN#
3	0.22	6.3	X6S	10nF	±10%	CL02X103KQ2NHN#

Size Code (inch/mm) : 0201/0603

No.	Thickness Max. (mm)	Rated Voltage (Vdc)	TCC	Capacitance	Capacitance Tolerance	Part Number
1	0.22	4	X6S	1uF	±20%	CL03X105MR2LRN#
2	0.33	6.3	X6S	100nF	±10%	CL03X104KQ3NHN#
3	0.33	6.3	X6S	220nF	±10%	CL03X224KQ3NHN#
4	0.33	6.3	X6S	220nF	±20%	CL03X224MQ3NHN#
5	0.33	6.3	X6S	470nF	±10%	CL03X474KQ3NHN#
6	0.33	25	X6S	100nF	±10%	CL03X104KA3NHN#
7	0.35	4	X6S	1uF	±20%	CL03X105MR3CSN#
8	0.39	2.5	X6S	2.2uF	±20%	CL03X225MS3NRN#
9	0.39	4	X6S	1uF	±20%	CL03X105MR3NRN#
10	0.39	4	X6S	2.2uF	±20%	CL03X225MR3NRN#

Size Code (inch/mm) : 0402/1005

No.	Thickness Max. (mm)	Rated Voltage (Vdc)	TCC	Capacitance	Capacitance Tolerance	Part Number
1	0.33	10	X6S	1uF	±20%	CL05X105MP3JQN#
2	0.55	6.3	X6S	1uF	±10%	CL05X105KQ5NFN#
3	0.55	6.3	X6S	1uF	±10%	CL05X105KQ5NHN#
4	0.55	10	X6S	1uF	±10%	CL05X105KP5NHN#
5	0.57	2.5	X6S	2.2uF	±20%	CL05X225MS5NSN#
6	0.57	6.3	X6S	2.2uF	±20%	CL05X225MQ5NSN#
7	0.60	25	X6S	1uF	±10%	CL05X105KA5NQN#
8	0.70	4	X6S	4.7uF	±20%	CL05X475MR5NUN#
9	0.70	6.3	X6S	4.7uF	±20%	CL05X475MQ5NUN#
10	0.70	6.3	X6S	10uF	±20%	CL05X106MQ5IUN#
11	0.70	25	X6S	2.2uF	±20%	CL05X225MA5NUN#
12	0.80	4	X6S	22uF	±20%	CL05X226MR6NUN#



# Normal Capacitors\_Standard

Size Code (inch/mm) : 0603/1608

No.	Thickness Max. (mm)	Rated Voltage (Vdc)	TCC	Capacitance	Capacitance Tolerance	Part Number
1	0.90	4	X6S	10uF	±10%	CL10X106KR8NINN#
2	0.90	6.3	X6S	4.7uF	±10%	CL10X475KQ8NINN#
3	0.90	6.3	X6S	4.7uF	±20%	CL10X475MQ8NINN#
4	0.90	6.3	X6S	10uF	±20%	CL10X106MQ8NINN#
5	0.90	10	X6S	2.2uF	±10%	CL10X225KP8NINN#
6	0.90	16	X6S	1uF	±10%	CL10X105K08NINN#
7	0.90	50	X6S	1uF	±10%	CL10X105KB8NINN#
8	0.95	16	X6S	4.7uF	±10%	CL10X475K08NFQ#
9	0.95	16	X6S	4.7uF	±10%	CL10X475K08NQN#
10	1.00	4	X6S	22uF	±20%	CL10X226MR8QRN#
11	1.00	6.3	X6S	22uF	±20%	CL10X226MQ8QRN#
12	1.00	10	X6S	10uF	±20%	CL10X106MP8NFR#
13	1.00	10	X6S	10uF	±20%	CL10X106MP8NRN#
14	1.00	16	X6S	4.7uF	±10%	CL10X475K08NRN#
15	1.00	16	X6S	10uF	±20%	CL10X106M08NRN#
16	1.00	25	X6S	4.7uF	±10%	CL10X475KA8NRN#
17	1.00	35	X6S	2.2uF	±10%	CL10X225KL8NRN#
18	1.05	4	X6S	22uF	±20%	CL10X226MR8NUN#

Size Code (inch/mm) : 0805/2012

No.	Thickness Max. (mm)	Rated Voltage (Vdc)	TCC	Capacitance	Capacitance Tolerance	Part Number
1	0.95	2.5	X6S	22uF	±20%	CL21X226MSCLR#
2	0.95	6.3	X6S	10uF	±10%	CL21X106KQCLR#
3	0.95	10	X6S	10uF	±10%	CL21X106KPCLR#
4	1.35	4	X6S	10uF	±20%	CL21X106MRFN#
5	1.35	16	X6S	2.2uF	±10%	CL21X225KOFN#
6	1.40	4	X6S	22uF	±20%	CL21X226MRQNF#
7	1.40	4	X6S	22uF	±20%	CL21X226MRQNN#
8	1.40	6.3	X6S	10uF	±10%	CL21X106KQQNN#
9	1.40	6.3	X6S	22uF	±20%	CL21X226MQQNF#
10	1.40	6.3	X6S	22uF	±20%	CL21X226MQQNN#
11	1.40	16	X6S	10uF	±10%	CL21X106KQQNN#
12	1.40	16	X6S	10uF	±20%	CL21X106MQQNN#
13	1.40	25	X6S	4.7uF	±10%	CL21X475KAQNN#
14	1.45	4	X6S	22uF	±20%	CL21X226MRYNN#
15	1.45	4	X6S	47uF	±20%	CL21X476MRYNN#
16	1.45	10	X6S	10uF	±10%	CL21X106KPYNN#
17	1.45	25	X6S	10uF	±10%	CL21X106KAYNN#
18	1.45	25	X6S	10uF	±10%	CL21X106KAYQNN#

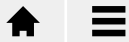

# Normal Capacitors\_Standard

Size Code (inch/mm) : 1206/3216

No.	Thickness Max. (mm)	Rated Voltage (Vdc)	TCC	Capacitance	Capacitance Tolerance	Part Number
1	1.80	4	X6S	47uF	±20%	CL31X476MRHNNN#
2	1.80	6.3	X6S	22uF	±10%	CL31X226KQHNNN#
3	1.80	6.3	X6S	47uF	±10%	CL31X476KQHNNN#
4	1.80	6.3	X6S	47uF	±20%	CL31X476MQHNFN#
5	1.80	10	X6S	22uF	±10%	CL31X226KPHN3N#
6	1.80	16	X6S	22uF	±10%	CL31X226KOHN3N#
7	1.80	16	X6S	22uF	±10%	CL31X226KOHNNN#
8	1.80	25	X6S	10uF	±10%	CL31X106KAHNNN#
9	1.80	25	X6S	22uF	±10%	CL31X226KAHN3N#
10	1.80	25	X6S	22uF	±10%	CL31X226KAHNF3#

Size Code (inch/mm) : 1210/3225

No.	Thickness Max. (mm)	Rated Voltage (Vdc)	TCC	Capacitance	Capacitance Tolerance	Part Number
1	2.70	10	X6S	47uF	±10%	CL32X476KPJNNN#
2	2.80	6.3	X6S	100uF	±20%	CL32X107MQVNNN#

## Product Lineup (X6T)

Size Code (inch/mm) : 01005/0402

No.	Thickness Max. (mm)	Rated Voltage (Vdc)	TCC	Capacitance	Capacitance Tolerance	Part Number
1	0.22	4	X6T	470nF	±20%	CL02W474MR2NNN#

Size Code (inch/mm) : 0201/0603

No.	Thickness Max. (mm)	Rated Voltage (Vdc)	TCC	Capacitance	Capacitance Tolerance	Part Number
1	0.39	4	X6T	2.2uF	±20%	CL03W225MR3CRN#

Size Code (inch/mm) : 0402/1005

No.	Thickness Max. (mm)	Rated Voltage (Vdc)	TCC	Capacitance	Capacitance Tolerance	Part Number
1	0.22	2.5	X6T	2.2uF	±20%	CL05W225MS2LUN#
2	0.70	2.5	X6T	20uF	±20%	CL05W206MS5CUN#

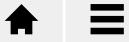

# Normal Capacitors\_Standard

## Product Lineup (Y5V)

Size Code (inch/mm) : 0402/1005

No.	Thickness Max. (mm)	Rated Voltage (Vdc)	TCC	Capacitance	Capacitance Tolerance	Part Number
1	0.55	6.3	Y5V	1uF	-20/+80%	CL05F105ZQ5NNN#
2	0.55	10	Y5V	330nF	-20/+80%	CL05F334ZP5NNN#
3	0.55	10	Y5V	470nF	-20/+80%	CL05F474ZP5NNN#
4	0.55	16	Y5V	22nF	-20/+80%	CL05F223ZO5NNN#
5	0.55	16	Y5V	33nF	-20/+80%	CL05F333ZO5NNN#
6	0.55	16	Y5V	47nF	-20/+80%	CL05F473ZO5NNN#
7	0.55	16	Y5V	100nF	-20/+80%	CL05F104ZO5NNN#
8	0.55	25	Y5V	22nF	-20/+80%	CL05F223ZA5NNN#
9	0.55	25	Y5V	33nF	-20/+80%	CL05F333ZA5NNN#
10	0.55	50	Y5V	15nF	-20/+80%	CL05F153ZB5NNN#

Size Code (inch/mm) : 0603/1608

No.	Thickness Max. (mm)	Rated Voltage (Vdc)	TCC	Capacitance	Capacitance Tolerance	Part Number
1	0.90	6.3	Y5V	2.2uF	-20/+80%	CL10F225ZQ8NNN#
2	0.90	10	Y5V	2.2uF	-20/+80%	CL10F225ZP8NNN#
3	0.90	16	Y5V	100nF	-20/+80%	CL10F104ZO8NNN#
4	0.90	16	Y5V	330nF	-20/+80%	CL10F334ZO8NNN#
5	0.90	25	Y5V	100nF	-20/+80%	CL10F104ZA8NNN#
6	0.90	25	Y5V	150nF	-20/+80%	CL10F154ZA8NNN#
7	0.90	25	Y5V	330nF	-20/+80%	CL10F334ZA8NNN#
8	0.90	25	Y5V	470nF	-20/+80%	CL10F474ZA8NNN#
9	0.90	50	Y5V	10nF	-20/+80%	CL10F103ZB8NNN#
10	0.90	50	Y5V	22nF	-20/+80%	CL10F223ZB8NNN#
11	0.90	50	Y5V	33nF	-20/+80%	CL10F333ZB8NNN#
12	0.90	50	Y5V	39nF	-20/+80%	CL10F393ZB8NNN#
13	0.90	50	Y5V	68nF	-20/+80%	CL10F683ZB8NNN#
14	0.90	50	Y5V	100nF	-20/+80%	CL10F104ZB8NNN#



# Normal Capacitors\_Standard

Size Code (inch/mm) : 0805/2012

No.	Thickness Max. (mm)	Rated Voltage (Vdc)	TCC	Capacitance	Capacitance Tolerance	Part Number
1	0.75	16	Y5V	680nF	-20/+80%	CL21F684ZOANNN#
2	0.75	25	Y5V	100nF	-20/+80%	CL21F104ZAANNN#
3	0.75	25	Y5V	220nF	-20/+80%	CL21F224ZAANNN#
4	0.75	50	Y5V	10nF	-20/+80%	CL21F103ZBANNN#
5	0.75	50	Y5V	22nF	-20/+80%	CL21F223ZBANNN#
6	0.75	50	Y5V	47nF	-20/+80%	CL21F473ZBANNN#
7	0.75	50	Y5V	100nF	-20/+80%	CL21F104ZBANNN#
8	0.95	25	Y5V	330nF	-20/+80%	CL21F334ZACNNN#
9	0.95	25	Y5V	470nF	-20/+80%	CL21F474ZACNNN#
10	0.95	50	Y5V	100nF	±20%	CL21F104MBCNNN#
11	0.95	50	Y5V	150nF	-20/+80%	CL21F154ZBCNNN#
12	0.95	50	Y5V	220nF	-20/+80%	CL21F224ZBCNNN#
13	1.35	6.3	Y5V	10uF	-20/+80%	CL21F106ZQFNNN#
14	1.35	10	Y5V	2.2uF	-20/+80%	CL21F225ZPFNNN#
15	1.35	10	Y5V	3.3uF	-20/+80%	CL21F335ZPFNNN#
16	1.35	10	Y5V	4.7uF	-20/+80%	CL21F475ZPFNNN#
17	1.35	16	Y5V	2.2uF	-20/+80%	CL21F225ZOFNNN#
18	1.35	50	Y5V	1uF	-20/+80%	CL21F105ZBFNNN#
19	1.35	50	Y5V	330nF	-20/+80%	CL21F334ZBFNNN#

Size Code (inch/mm) : 1206/3216

No.	Thickness Max. (mm)	Rated Voltage (Vdc)	TCC	Capacitance	Capacitance Tolerance	Part Number
1	1.00	16	Y5V	1uF	-20/+80%	CL31F105ZOCNNN#
2	1.00	16	Y5V	2.2uF	-20/+80%	CL31F225ZOCNNN#
3	1.00	25	Y5V	1uF	-20/+80%	CL31F105ZACNNN#
4	1.00	50	Y5V	100nF	-20/+80%	CL31F104ZBCNNN#
5	1.00	50	Y5V	220nF	-20/+80%	CL31F224ZBCNNN#
6	1.00	50	Y5V	330nF	-20/+80%	CL31F334ZBCNNN#
7	1.00	50	Y5V	470nF	-20/+80%	CL31F474ZBCNNN#
8	1.40	10	Y5V	10uF	-20/+80%	CL31F106ZPFNNN#
9	1.40	16	Y5V	3.3uF	-20/+80%	CL31F335ZOFNNN#
10	1.40	16	Y5V	4.7uF	-20/+80%	CL31F475ZOFNNN#
11	1.40	25	Y5V	2.2uF	-20/+80%	CL31F225ZAFNNN#
12	1.40	50	Y5V	1uF	-20/+80%	CL31F105ZBFNNN#
13	1.80	10	Y5V	10uF	-20/+80%	CL31F106ZPHNNN#



# Normal Capacitors\_Standard

Size Code (inch/mm) : 1210/3225

No.	Thickness Max. (mm)	Rated Voltage (Vdc)	TCC	Capacitance	Capacitance Tolerance	Part Number
1	1.45	50	Y5V	1uF	-20/+80%	CL32F105ZBFNNN#
2	1.50	25	Y5V	10uF	-20/+80%	CL32F106ZASLNN#
3	1.60	35	Y5V	10uF	-20/+80%	CL32F106ZLGNNN#
4	1.80	16	Y5V	10uF	-20/+80%	CL32F106ZOHNNN#
5	1.80	25	Y5V	10uF	-20/+80%	CL32F106ZAHNNN#
6	1.80	35	Y5V	10uF	-20/+80%	CL32F106ZLHNNN#

## Product Lineup (X7R)

Size Code (inch/mm) : 01005/0402

No.	Thickness Max. (mm)	Rated Voltage (Vdc)	TCC	Capacitance	Capacitance Tolerance	Part Number
1	0.22	10	X7R	1nF	±10%	CL02B102KP2NNN#
2	0.22	10	X7R	100pF	±10%	CL02B101KP2NNN#
3	0.22	10	X7R	120pF	±10%	CL02B121KP2NNN#
4	0.22	10	X7R	220pF	±10%	CL02B221KP2NNN#
5	0.22	10	X7R	470pF	±10%	CL02B471KP2NNN#
6	0.22	16	X7R	330pF	±10%	CL02B331K02NNN#

Size Code (inch/mm) : 0201/0603

No.	Thickness Max. (mm)	Rated Voltage (Vdc)	TCC	Capacitance	Capacitance Tolerance	Part Number
1	0.33	6.3	X7R	4.7nF	±10%	CL03B472KQ3NNN#
2	0.33	6.3	X7R	10nF	±10%	CL03B103KQ3NNN#
3	0.33	10	X7R	1.5nF	±10%	CL03B152KP3NNN#
4	0.33	10	X7R	3.3nF	±10%	CL03B332KP3NNN#
5	0.33	10	X7R	6.8nF	±10%	CL03B682KP3NNN#
6	0.33	10	X7R	10nF	±10%	CL03B103KP3NNN#
7	0.33	16	X7R	1nF	±10%	CL03B102K03NNN#
8	0.33	16	X7R	10nF	±10%	CL03B103K03NNN#
9	0.33	16	X7R	150pF	±10%	CL03B151K03NNN#
10	0.33	16	X7R	220pF	±10%	CL03B221K03NNN#
11	0.33	16	X7R	270pF	±10%	CL03B271K03NNN#
12	0.33	16	X7R	470pF	±10%	CL03B471K03NNN#
13	0.33	16	X7R	560pF	±10%	CL03B561K03NNN#
14	0.33	16	X7R	820pF	±10%	CL03B821K03NNN#
15	0.33	25	X7R	1nF	±10%	CL03B102KA3NNN#
16	0.33	25	X7R	1nF	±5%	CL03B102JA3NNN#
17	0.33	25	X7R	150pF	±10%	CL03B151KA3NNN#
18	0.33	25	X7R	220pF	±10%	CL03B221KA3NNN#
19	0.33	25	X7R	330pF	±10%	CL03B331KA3NNN#
18	0.33	25	X7R	470pF	±10%	CL03B471KA3NNN#
21	0.33	25	X7R	680pF	±10%	CL03B681KA3NNN#

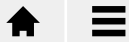

# Normal Capacitors\_Standard

Size Code (inch/mm) : 0402/1005

No.	Thickness Max. (mm)	Rated Voltage (Vdc)	TCC	Capacitance	Capacitance Tolerance	Part Number
1	0.33	16	X7R	100nF	±10%	CL05B104K03LNN#
2	0.55	6.3	X7R	100nF	±10%	CL05B104KQ5NINN#
3	0.55	6.3	X7R	470nF	±10%	CL05B474KQ5NINN#
4	0.55	10	X7R	22nF	±10%	CL05B223KP5NINN#
5	0.55	10	X7R	27nF	±10%	CL05B273KP5NINN#
6	0.55	10	X7R	47nF	±10%	CL05B473KP5NINN#
7	0.55	10	X7R	68nF	±10%	CL05B683KP5NINN#
8	0.55	10	X7R	82nF	±10%	CL05B823KP5NINN#
9	0.55	10	X7R	100nF	±10%	CL05B104KP5NFN#
10	0.55	10	X7R	100nF	±10%	CL05B104KP5NINN#
11	0.55	10	X7R	100nF	±20%	CL05B104MP5NINN#
12	0.55	10	X7R	220nF	±10%	CL05B224KP5NINN#
13	0.55	10	X7R	470nF	±10%	CL05B474KP5NINN#
14	0.55	16	X7R	8.2nF	±10%	CL05B822K05NINN#
15	0.55	16	X7R	10nF	±10%	CL05B103K05NCN#
16	0.55	16	X7R	10nF	±10%	CL05B103K05NFN#
17	0.55	16	X7R	10nF	±10%	CL05B103K05NINN#
18	0.55	16	X7R	10nF	±5%	CL05B103J05NINN#
19	0.55	16	X7R	22nF	±10%	CL05B223K05NFN#
20	0.55	16	X7R	22nF	±10%	CL05B223K05NINN#
21	0.55	16	X7R	22nF	±5%	CL05B223J05NINN#
22	0.55	16	X7R	27nF	±10%	CL05B273K05NINN#
23	0.55	16	X7R	33nF	±10%	CL05B333K05NFN#
24	0.55	16	X7R	33nF	±10%	CL05B333K05NINN#
25	0.55	16	X7R	33nF	±5%	CL05B333J05NINN#
26	0.55	16	X7R	47nF	±10%	CL05B473K05NFN#
27	0.55	16	X7R	47nF	±10%	CL05B473K05NINN#
28	0.55	16	X7R	47nF	±5%	CL05B473J05NINN#
29	0.55	16	X7R	68nF	±10%	CL05B683K05NINN#
30	0.55	16	X7R	100nF	±10%	CL05B104K05NFN#
31	0.55	16	X7R	100nF	±10%	CL05B104K05NINN#
32	0.55	16	X7R	100nF	±20%	CL05B104M05NINN#
33	0.55	16	X7R	100nF	±5%	CL05B104J05NINN#
34	0.55	16	X7R	220nF	±10%	CL05B224K05NFN#
35	0.55	16	X7R	220nF	±10%	CL05B224K05NINN#
36	0.55	16	X7R	820pF	±10%	CL05B821K05NINN#
37	0.55	25	X7R	1.5nF	±10%	CL05B152KA5NINN#
38	0.55	25	X7R	3.3nF	±5%	CL05B332JA5NINN#
39	0.55	25	X7R	4.7nF	±10%	CL05B472KA5NFN#
40	0.55	25	X7R	4.7nF	±10%	CL05B472KA5NINN#
41	0.55	25	X7R	5.6nF	±10%	CL05B562KA5NINN#
42	0.55	25	X7R	6.8nF	±10%	CL05B682KA5NINN#
43	0.55	25	X7R	8.2nF	±10%	CL05B822KA5NINN#
44	0.55	25	X7R	10nF	±10%	CL05B103KA5NFN#
45	0.55	25	X7R	10nF	±10%	CL05B103KA5NINN#



# Normal Capacitors\_Standard

Size Code (inch/mm) : 0402/1005

No.	Thickness Max. (mm)	Rated Voltage (Vdc)	TCC	Capacitance	Capacitance Tolerance	Part Number
46	0.55	25	X7R	18nF	±10%	CL05B183KA5NHN#
47	0.55	25	X7R	22nF	±10%	CL05B223KA5NHN#
48	0.55	25	X7R	47nF	±10%	CL05B473KA5NHN#
49	0.55	25	X7R	100nF	±10%	CL05B104KA5NHN#
50	0.55	25	X7R	100nF	±10%	CL05B104KA5SN#
51	0.55	25	X7R	560pF	±10%	CL05B561KA5NHN#
52	0.55	50	X7R	1nF	±10%	CL05B102KB5NHN#
53	0.55	50	X7R	1nF	±10%	CL05B102KB5NHN#
54	0.55	50	X7R	1nF	±10%	CL05B102KB5NHN#
55	0.55	50	X7R	1nF	±5%	CL05B102JB5NHN#
56	0.55	50	X7R	1.2nF	±5%	CL05B122JB5NHN#
57	0.55	50	X7R	1.5nF	±10%	CL05B152KB5NHN#
58	0.55	50	X7R	1.5nF	±5%	CL05B152JB5NHN#
59	0.55	50	X7R	1.8nF	±10%	CL05B182KB5NHN#
60	0.55	50	X7R	2.2nF	±10%	CL05B222KB5NHN#
61	0.55	50	X7R	2.2nF	±10%	CL05B222KB5NHN#
62	0.55	50	X7R	2.2nF	±5%	CL05B222JB5NHN#
63	0.55	50	X7R	2.7nF	±10%	CL05B272KB5NHN#
64	0.55	50	X7R	3.3nF	±10%	CL05B332KB5NHN#
65	0.55	50	X7R	3.3nF	±10%	CL05B332KB5NHN#
66	0.55	50	X7R	3.9nF	±10%	CL05B392KB5NHN#
67	0.55	50	X7R	4.7nF	±10%	CL05B472KB5NHN#
68	0.55	50	X7R	4.7nF	±10%	CL05B472KB5NHN#
69	0.55	50	X7R	4.7nF	±5%	CL05B472JB5NHN#
70	0.55	50	X7R	5.6nF	±10%	CL05B562KB5NHN#
71	0.55	50	X7R	5.6nF	±10%	CL05B562KB5NHN#
72	0.55	50	X7R	6.8nF	±10%	CL05B682KB5NHN#
73	0.55	50	X7R	6.8nF	±5%	CL05B682JB5NHN#
74	0.55	50	X7R	8.2nF	±10%	CL05B822KB5NHN#
75	0.55	50	X7R	10nF	±10%	CL05B103KB5NHN#
76	0.55	50	X7R	10nF	±10%	CL05B103KB5NHN#
77	0.55	50	X7R	15nF	±10%	CL05B153KB5NHN#
78	0.55	50	X7R	22nF	±10%	CL05B223KB5NHN#
79	0.55	50	X7R	100nF	±10%	CL05B104KB5NHN#
80	0.55	50	X7R	100nF	±10%	CL05B104KB5NHN#
81	0.55	50	X7R	150pF	±10%	CL05B151KB5NHN#
82	0.55	50	X7R	180pF	±10%	CL05B181KB5NHN#
83	0.55	50	X7R	220pF	±10%	CL05B221KB5NHN#
84	0.55	50	X7R	220pF	±5%	CL05B221JB5NHN#
85	0.55	50	X7R	300pF	±10%	CL05B301KB5NHN#
86	0.55	50	X7R	330pF	±10%	CL05B331KB5NHN#
87	0.55	50	X7R	330pF	±5%	CL05B331JB5NHN#
88	0.55	50	X7R	390pF	±10%	CL05B391KB5NHN#
89	0.55	50	X7R	470pF	±10%	CL05B471KB5NHN#
90	0.55	50	X7R	470pF	±10%	CL05B471KB5NHN#
91	0.55	50	X7R	560pF	±5%	CL05B561JB5NHN#
92	0.55	50	X7R	680pF	±10%	CL05B681KB5NHN#
93	0.55	50	X7R	680pF	±5%	CL05B681JB5NHN#



# Normal Capacitors\_Standard

Size Code (inch/mm) : 0603/1608

No.	Thickness Max. (mm)	Rated Voltage (Vdc)	TCC	Capacitance	Capacitance Tolerance	Part Number
1	0.90	6.3	X7R	1uF	±10%	CL10B105KQ8NNN#
2	0.90	6.3	X7R	2.2uF	±10%	CL10B225KQ8NFN#
3	0.90	6.3	X7R	2.2uF	±10%	CL10B225KQ8NNN#
4	0.90	6.3	X7R	470nF	±10%	CL10B474KQ8NNN#
5	0.90	6.3	X7R	680nF	±10%	CL10B684KQ8NNN#
6	0.90	10	X7R	1uF	±10%	CL10B105KP8NFN#
7	0.90	10	X7R	1uF	±10%	CL10B105KP8NNN#
8	0.90	10	X7R	2.2uF	±10%	CL10B225KP8NFN#
9	0.90	10	X7R	2.2uF	±10%	CL10B225KP8NNN#
10	0.90	10	X7R	220nF	±10%	CL10B224KP8NFN#
11	0.90	10	X7R	220nF	±5%	CL10B224JP8NNN#
12	0.90	10	X7R	330nF	±10%	CL10B334KP8NNN#
13	0.90	10	X7R	470nF	±10%	CL10B474KP8NNN#
14	0.90	16	X7R	1uF	±10%	CL10B105K08NFN#
15	0.90	16	X7R	1uF	±10%	CL10B105K08NNN#
16	0.90	16	X7R	1uF	±10%	CL10B105K08SFN#
17	0.90	16	X7R	1uF	±10%	CL10B105K08ZFN#
18	0.90	16	X7R	10nF	±10%	CL10B103K08NNN#
19	0.90	16	X7R	15nF	±10%	CL10B153K08NNN#
20	0.90	16	X7R	22nF	±10%	CL10B223K08NNN#
21	0.90	16	X7R	27nF	±10%	CL10B273K08NNN#
22	0.90	16	X7R	33nF	±10%	CL10B333K08NFN#
23	0.90	16	X7R	39nF	±10%	CL10B393K08NNN#
24	0.90	16	X7R	47nF	±10%	CL10B473K08NFN#
25	0.90	16	X7R	47nF	±10%	CL10B473K08NNN#
26	0.90	16	X7R	47nF	±5%	CL10B473J08NNN#
27	0.90	16	X7R	56nF	±10%	CL10B563K08NNN#
28	0.90	16	X7R	82nF	±10%	CL10B823K08NNN#
29	0.90	16	X7R	100nF	±10%	CL10B104K08NFN#
30	0.90	16	X7R	100nF	±10%	CL10B104K08NNN#
31	0.90	16	X7R	150nF	±10%	CL10B154K08NFN#
32	0.90	16	X7R	150nF	±10%	CL10B154K08NNN#
33	0.90	16	X7R	220nF	±10%	CL10B224K08NFN#
34	0.90	16	X7R	220nF	±10%	CL10B224K08NNN#
35	0.90	16	X7R	220nF	±10%	CL10B224K08SFN#
36	0.90	16	X7R	220nF	±5%	CL10B224J08NNN#
37	0.90	16	X7R	220nF	±5%	CL10B224J08SFN#
38	0.90	16	X7R	330nF	±10%	CL10B334K08NFN#
39	0.90	16	X7R	330nF	±10%	CL10B334K08NNN#
40	0.90	16	X7R	470nF	±10%	CL10B474K08NFN#
41	0.90	16	X7R	470nF	±10%	CL10B474K08NNN#
42	0.90	16	X7R	680nF	±10%	CL10B684K08NFN#
43	0.90	25	X7R	1uF	±10%	CL10B105KA8NFN#
44	0.90	25	X7R	1uF	±10%	CL10B105KA8NNN#
45	0.90	25	X7R	1uF	±10%	CL10B105KA8ZFN#



# Normal Capacitors\_Standard

Size Code (inch/mm) : 0603/1608

No.	Thickness Max. (mm)	Rated Voltage (Vdc)	TCC	Capacitance	Capacitance Tolerance	Part Number
46	0.90	25	X7R	4.7nF	±10%	CL10B472KA8NNN#
47	0.90	25	X7R	10nF	±10%	CL10B103KA8NFN#
48	0.90	25	X7R	10nF	±10%	CL10B103KA8NNN#
49	0.90	25	X7R	22nF	±10%	CL10B223KA8NFN#
50	0.90	25	X7R	27nF	±10%	CL10B273KA8NNN#
51	0.90	25	X7R	47nF	±10%	CL10B473KA8NFN#
52	0.90	25	X7R	56nF	±10%	CL10B563KA8NNN#
53	0.90	25	X7R	68nF	±10%	CL10B683KA8NNN#
54	0.90	25	X7R	100nF	±10%	CL10B104KA8NFN#
55	0.90	25	X7R	100nF	±10%	CL10B104KA8NNN#
56	0.90	25	X7R	100nF	±5%	CL10B104JA8NNN#
57	0.90	25	X7R	150nF	±10%	CL10B154KA8NFN#
58	0.90	25	X7R	220nF	±10%	CL10B224KA8NFN#
59	0.90	25	X7R	220nF	±10%	CL10B224KA8NNN#
60	0.90	25	X7R	220nF	±10%	CL10B224KA8SFN#
61	0.90	25	X7R	470nF	±10%	CL10B474KA8NFN#
62	0.90	25	X7R	470nF	±10%	CL10B474KA8NNN#
63	0.90	25	X7R	470nF	±10%	CL10B474KA8SNN#
64	0.90	50	X7R	1nF	±10%	CL10B102KB8NCC#
65	0.90	50	X7R	1nF	±10%	CL10B102KB8NFN#
66	0.90	50	X7R	1nF	±10%	CL10B102KB8NNN#
67	0.90	50	X7R	1nF	±10%	CL10B102KB8SFN#
68	0.90	50	X7R	1nF	±5%	CL10B102JB8NFN#
69	0.90	50	X7R	1.2nF	±10%	CL10B122KB8NFN#
70	0.90	50	X7R	1.2nF	±10%	CL10B122KB8NNN#
71	0.90	50	X7R	1.5nF	±10%	CL10B152KB8NFN#
72	0.90	50	X7R	1.5nF	±10%	CL10B152KB8NNN#
73	0.90	50	X7R	1.5nF	±10%	CL10B152KB8SFN#
74	0.90	50	X7R	1.8nF	±10%	CL10B182KB8NFN#
75	0.90	50	X7R	2nF	±10%	CL10B202KB8NNN#
76	0.90	50	X7R	2.2nF	±10%	CL10B222KB8NFN#
77	0.90	50	X7R	2.2nF	±10%	CL10B222KB8NNN#
78	0.90	50	X7R	2.2nF	±10%	CL10B222KB8SFN#
79	0.90	50	X7R	2.2nF	±10%	CL10B222KB8ZNN#
80	0.90	50	X7R	2.7nF	±10%	CL10B272KB8NFN#
81	0.90	50	X7R	2.7nF	±10%	CL10B272KB8NNN#
82	0.90	50	X7R	2.7nF	±10%	CL10B272KB8SFN#
83	0.90	50	X7R	2.7nF	±5%	CL10B272JB8NNN#
84	0.90	50	X7R	3.3nF	±10%	CL10B332KB8NFN#
85	0.90	50	X7R	3.3nF	±10%	CL10B332KB8NNN#
86	0.90	50	X7R	3.3nF	±20%	CL10B332MB8NNN#
87	0.90	50	X7R	3.9nF	±10%	CL10B392KB8NFN#
88	0.90	50	X7R	3.9nF	±10%	CL10B392KB8NNN#
89	0.90	50	X7R	4.7nF	±10%	CL10B472KB8NFN#
90	0.90	50	X7R	4.7nF	±10%	CL10B472KB8NNN#



# Normal Capacitors\_Standard

Size Code (inch/mm) : 0603/1608

No.	Thickness Max. (mm)	Rated Voltage (Vdc)	TCC	Capacitance	Capacitance Tolerance	Part Number
91	0.90	50	X7R	4.7nF	±10%	CL10B472KB8SFN#
92	0.90	50	X7R	4.7nF	±10%	CL10B472KB8ZNN#
93	0.90	50	X7R	5.6nF	±10%	CL10B562KB8NFN#
94	0.90	50	X7R	5.6nF	±10%	CL10B562KB8NNN#
95	0.90	50	X7R	5.6nF	±5%	CL10B562JB8NNN#
96	0.90	50	X7R	6.8nF	±10%	CL10B682KB8NFN#
97	0.90	50	X7R	6.8nF	±10%	CL10B682KB8NNN#
98	0.90	50	X7R	6.8nF	±5%	CL10B682JB8NNN#
99	0.90	50	X7R	8.2nF	±10%	CL10B822KB8NFN#
100	0.90	50	X7R	10nF	±10%	CL10B103KB8NFN#
101	0.90	50	X7R	10nF	±10%	CL10B103KB8NNN#
102	0.90	50	X7R	10nF	±10%	CL10B103KB8ZNN#
103	0.90	50	X7R	10nF	±20%	CL10B103MB8NCN#
104	0.90	50	X7R	10nF	±20%	CL10B103MB8NNN#
105	0.90	50	X7R	10nF	±5%	CL10B103JB8NFN#
106	0.90	50	X7R	12nF	±10%	CL10B123KB8NNN#
107	0.90	50	X7R	15nF	±10%	CL10B153KB8NFN#
108	0.90	50	X7R	15nF	±10%	CL10B153KB8NNN#
109	0.90	50	X7R	15nF	±10%	CL10B153KB8SFN#
110	0.90	50	X7R	18nF	±5%	CL10B183JB8NNN#
111	0.90	50	X7R	20nF	±10%	CL10B203KB8NNN#
112	0.90	50	X7R	22nF	±10%	CL10B223KB8NFN#
113	0.90	50	X7R	22nF	±10%	CL10B223KB8NNN#
114	0.90	50	X7R	22nF	±10%	CL10B223KB8SFN#
115	0.90	50	X7R	22nF	±5%	CL10B223JB8NFN#
116	0.90	50	X7R	27nF	±10%	CL10B273KB8NNN#
117	0.90	50	X7R	33nF	±10%	CL10B333KB8NFN#
118	0.90	50	X7R	33nF	±10%	CL10B333KB8NNN#
119	0.90	50	X7R	33nF	±10%	CL10B333KB8SFN#
120	0.90	50	X7R	39nF	±10%	CL10B393KB8NNN#
121	0.90	50	X7R	47nF	±10%	CL10B473KB8NFN#
122	0.90	50	X7R	47nF	±10%	CL10B473KB8NNN#
123	0.90	50	X7R	47nF	±10%	CL10B473KB8SFN#
124	0.90	50	X7R	47nF	±10%	CL10B473KB8ZNN#
125	0.90	50	X7R	47nF	±5%	CL10B473JB8NNN#
126	0.90	50	X7R	56nF	±10%	CL10B563KB8SFN#
127	0.90	50	X7R	68nF	±10%	CL10B683KB8NFN#
128	0.90	50	X7R	68nF	±10%	CL10B683KB8NNN#
129	0.90	50	X7R	82nF	±10%	CL10B823KB8NFN#
130	0.90	50	X7R	100nF	±10%	CL10B104KB8NFN#
131	0.90	50	X7R	100nF	±10%	CL10B104KB8NNN#
132	0.90	50	X7R	100nF	±10%	CL10B104KB8SFN#
133	0.90	50	X7R	100nF	±10%	CL10B104KB8ZNN#
134	0.90	50	X7R	100nF	±20%	CL10B104MB8NFN#
135	0.90	50	X7R	100nF	±20%	CL10B104MB8NNN#



# Normal Capacitors\_Standard

Size Code (inch/mm) : 0603/1608

No.	Thickness Max. (mm)	Rated Voltage (Vdc)	TCC	Capacitance	Capacitance Tolerance	Part Number
136	0.90	50	X7R	100nF	±5%	CL10B104JB8NNN#
137	0.90	50	X7R	100pF	±10%	CL10B101KB8NFN#
138	0.90	50	X7R	120pF	±10%	CL10B121KB8NNN#
139	0.90	50	X7R	150pF	±10%	CL10B151KB8NNN#
140	0.90	50	X7R	200pF	±10%	CL10B201KB8NNN#
141	0.90	50	X7R	220nF	±10%	CL10B224KB8NFN#
142	0.90	50	X7R	220nF	±10%	CL10B224KB8NNN#
143	0.90	50	X7R	220nF	±10%	CL10B224KB8SFN#
144	0.90	50	X7R	220nF	±10%	CL10B224KB8ZNN#
145	0.90	50	X7R	220pF	±10%	CL10B221KB8NFN#
146	0.90	50	X7R	220pF	±10%	CL10B221KB8NNN#
147	0.90	50	X7R	220pF	±5%	CL10B221JB8NNN#
148	0.90	50	X7R	330pF	±10%	CL10B331KB8NFN#
149	0.90	50	X7R	330pF	±10%	CL10B331KB8NNN#
150	0.90	50	X7R	330pF	±5%	CL10B331JB8NNN#
151	0.90	50	X7R	390pF	±10%	CL10B391KB8NNN#
152	0.90	50	X7R	470pF	±10%	CL10B471KB8NFN#
153	0.90	50	X7R	470pF	±10%	CL10B471KB8NNN#
154	0.90	50	X7R	470pF	±5%	CL10B471JB8NNN#
155	0.90	50	X7R	510pF	±10%	CL10B511KB8NNN#
156	0.90	50	X7R	560pF	±5%	CL10B561JB8NNN#
157	0.90	50	X7R	680pF	±10%	CL10B681KB8NFN#
158	0.90	50	X7R	680pF	±5%	CL10B681JB8NNN#
159	0.90	100	X7R	1nF	±10%	CL10B102KC8NFN#
160	0.90	100	X7R	1nF	±10%	CL10B102KC8NNN#
161	0.90	100	X7R	1.5nF	±10%	CL10B152KC8NNN#
162	0.90	100	X7R	3.3nF	±10%	CL10B332KC8NNN#
163	0.90	100	X7R	4.7nF	±10%	CL10B472KC8NNN#
164	0.90	100	X7R	10nF	±10%	CL10B103KC8NNN#
165	0.90	100	X7R	100nF	±10%	CL10B104KC8NNN#
166	0.95	6.3	X7R	4.7uF	±10%	CL10B475KQ8NFFQ#
167	0.95	6.3	X7R	4.7uF	±10%	CL10B475KQ8NQN#
168	0.95	6.3	X7R	4.7uF	±20%	CL10B475MQ8NQN#
169	0.95	50	X7R	1uF	±10%	CL10B105KB8NQN#
170	1.00	6.3	X7R	10uF	±20%	CL10B106MQ8NFR#
171	1.00	6.3	X7R	10uF	±20%	CL10B106MQ8NRN#

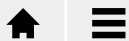

# Normal Capacitors\_Standard

Size Code (inch/mm) : 0805/2012

No.	Thickness Max. (mm)	Rated Voltage (Vdc)	TCC	Capacitance	Capacitance Tolerance	Part Number
1	0.75	16	X7R	100nF	±10%	CL21B104KOANNN#
2	0.75	16	X7R	150nF	±10%	CL21B154KOANNN#
3	0.75	16	X7R	180nF	±10%	CL21B184KOANNN#
4	0.75	25	X7R	1nF	±10%	CL21B102KAANFN#
5	0.75	25	X7R	10nF	±10%	CL21B103KAANNN#
6	0.75	50	X7R	1nF	±10%	CL21B102KBANFN#
7	0.75	50	X7R	1nF	±10%	CL21B102KBANNN#
8	0.75	50	X7R	1nF	±5%	CL21B102JBANFN#
9	0.75	50	X7R	1.2nF	±10%	CL21B122KBANNN#
10	0.75	50	X7R	2nF	±10%	CL21B202KBANNN#
11	0.75	50	X7R	2.2nF	±10%	CL21B222KBANFN#
12	0.75	50	X7R	2.2nF	±10%	CL21B222KBANNN#
13	0.75	50	X7R	2.2nF	±5%	CL21B222JBANNN#
14	0.75	50	X7R	2.7nF	±10%	CL21B272KBANNN#
15	0.75	50	X7R	3.3nF	±5%	CL21B332JBANNN#
16	0.75	50	X7R	3.9nF	±10%	CL21B392KBANNN#
17	0.75	50	X7R	4.7nF	±10%	CL21B472KBANFN#
18	0.75	50	X7R	4.7nF	±10%	CL21B472KBANNN#
19	0.75	50	X7R	5.6nF	±10%	CL21B562KBANFN#
20	0.75	50	X7R	5.6nF	±10%	CL21B562KBANNN#
21	0.75	50	X7R	5.6nF	±5%	CL21B562JBANNN#
22	0.75	50	X7R	6.8nF	±10%	CL21B682KBANFN#
23	0.75	50	X7R	8.2nF	±10%	CL21B822KBANNN#
24	0.75	50	X7R	10nF	±10%	CL21B103KBANFN#
25	0.75	50	X7R	10nF	±10%	CL21B103KBANNN#
26	0.75	50	X7R	10nF	±20%	CL21B103MBANNN#
27	0.75	50	X7R	15nF	±10%	CL21B153KBANFN#
28	0.75	50	X7R	15nF	±5%	CL21B153JBANNN#
29	0.75	50	X7R	18nF	±10%	CL21B183KBANNN#
30	0.75	50	X7R	20nF	±10%	CL21B203KBANNN#
31	0.75	50	X7R	22nF	±10%	CL21B223KBANFN#
32	0.75	50	X7R	22nF	±10%	CL21B223KBANNN#
33	0.75	50	X7R	22nF	±5%	CL21B223JBANNN#
34	0.75	50	X7R	27nF	±10%	CL21B273KBANNN#
35	0.75	50	X7R	33nF	±10%	CL21B333KBANFN#
36	0.75	50	X7R	39nF	±10%	CL21B393KBANNN#
37	0.75	50	X7R	100pF	±10%	CL21B101KBANFN#
38	0.75	50	X7R	180pF	±10%	CL21B181KBANNN#
39	0.75	50	X7R	200pF	±10%	CL21B201KBANNN#
40	0.75	50	X7R	220pF	±10%	CL21B221KBANFN#
41	0.75	50	X7R	300pF	±10%	CL21B301KBANNN#
42	0.75	50	X7R	330pF	±5%	CL21B331JBANNN#
43	0.75	50	X7R	470pF	±10%	CL21B471KBANFN#
44	0.75	50	X7R	470pF	±5%	CL21B471JBANNN#
45	0.75	50	X7R	510pF	±10%	CL21B511KBANNN#



# Normal Capacitors\_Standard

Size Code (inch/mm) : 0805/2012

No.	Thickness Max. (mm)	Rated Voltage (Vdc)	TCC	Capacitance	Capacitance Tolerance	Part Number
46	0.75	50	X7R	680pF	±10%	CL21B681KBANFN#
47	0.75	100	X7R	1nF	±10%	CL21B102KCANNN#
48	0.75	100	X7R	1nF	±5%	CL21B102JCANNN#
49	0.75	100	X7R	1.5nF	±10%	CL21B152KCANNN#
50	0.75	100	X7R	2.2nF	±10%	CL21B222KCANFN#
51	0.75	100	X7R	4.7nF	±10%	CL21B472KCANFN#
52	0.75	100	X7R	6.8nF	±10%	CL21B682KCANFN#
53	0.75	100	X7R	6.8nF	±10%	CL21B682KCANNN#
54	0.75	100	X7R	10nF	±10%	CL21B103KCANFN#
55	0.75	100	X7R	10nF	±10%	CL21B103KCANNN#
56	0.75	100	X7R	220pF	±10%	CL21B221KCANFN#
57	0.75	100	X7R	270pF	±10%	CL21B271KCANNN#
58	0.75	100	X7R	330pF	±10%	CL21B331KCANNN#
59	0.95	16	X7R	270nF	±10%	CL21B274KOCNNN#
60	0.95	16	X7R	330nF	±10%	CL21B334KOCNNN#
61	0.95	25	X7R	100nF	±10%	CL21B104KACNFN#
62	0.95	25	X7R	100nF	±10%	CL21B104KACNNN#
63	0.95	25	X7R	100nF	±20%	CL21B104MACNNN#
64	0.95	25	X7R	120nF	±10%	CL21B124KACNNN#
65	0.95	25	X7R	120nF	±5%	CL21B124JACNNN#
66	0.95	50	X7R	1nF	±10%	CL21B102KBCNNN#
67	0.95	50	X7R	2.2nF	±10%	CL21B222KBCNNN#
68	0.95	50	X7R	10nF	±10%	CL21B103KBCNNN#
69	0.95	50	X7R	10nF	±5%	CL21B103JBCNNN#
70	0.95	50	X7R	47nF	±10%	CL21B473KBCNFN#
71	0.95	50	X7R	47nF	±10%	CL21B473KBCNNN#
72	0.95	50	X7R	47nF	±20%	CL21B473MBCNNN#
73	0.95	50	X7R	56nF	±10%	CL21B563KBCNNN#
74	0.95	50	X7R	68nF	±10%	CL21B683KBCNFN#
75	0.95	50	X7R	68nF	±5%	CL21B683JBCNNN#
76	0.95	50	X7R	82nF	±10%	CL21B823KBCNNN#
77	0.95	50	X7R	100nF	±10%	CL21B104KBCNFN#
78	0.95	50	X7R	100nF	±10%	CL21B104KBCNNN#
79	0.95	50	X7R	100nF	±10%	CL21B104KBCSFN#
80	0.95	50	X7R	100nF	±5%	CL21B104JBCNFN#
81	0.95	100	X7R	15nF	±10%	CL21B153KCCNNN#
82	0.95	200	X7R	1nF	±10%	CL21B102KDCNFN#
83	0.95	200	X7R	1nF	±5%	CL21B102JDCNNN#
84	0.95	200	X7R	1.8nF	±10%	CL21B182KDCNNN#
85	0.95	200	X7R	2.2nF	±10%	CL21B222KDCNFN#
86	0.95	200	X7R	4.7nF	±10%	CL21B472KDCNNN#
87	0.95	200	X7R	10nF	±10%	CL21B103KDCNFN#
88	0.95	200	X7R	10nF	±10%	CL21B103KDCNNN#
89	0.95	200	X7R	220pF	±10%	CL21B221KDCNFN#
90	0.95	200	X7R	470pF	±10%	CL21B471KDCNFN#



# Normal Capacitors\_Standard

Size Code (inch/mm) : 0805/2012

No.	Thickness Max. (mm)	Rated Voltage (Vdc)	TCC	Capacitance	Capacitance Tolerance	Part Number
91	0.95	250	X7R	1nF	±10%	CL21B102KECSFN#
92	0.95	250	X7R	1nF	±10%	CL21B102KECSNN#
93	1.35	10	X7R	1uF	±10%	CL21B105KPFNNN#
94	1.35	10	X7R	1uF	±20%	CL21B105MPFNNN#
95	1.35	10	X7R	2.2uF	±10%	CL21B225KPFNNN#
96	1.35	10	X7R	3.3uF	±10%	CL21B335KPFNNN#
97	1.35	10	X7R	4.7uF	±10%	CL21B475KPFN3N#
98	1.35	10	X7R	4.7uF	±10%	CL21B475KPFNFN#
99	1.35	10	X7R	680nF	±10%	CL21B684KPFNNN#
100	1.35	16	X7R	1uF	±10%	CL21B105KOFNFN#
101	1.35	16	X7R	1uF	±10%	CL21B105KOFNNN#
102	1.35	16	X7R	1uF	±10%	CL21B105KOFSFN#
103	1.35	16	X7R	1uF	±20%	CL21B105MOFNNN#
104	1.35	16	X7R	2.2uF	±10%	CL21B225KOFNFN#
105	1.35	16	X7R	2.2uF	±10%	CL21B225KOFNNN#
106	1.35	16	X7R	4.7uF	±10%	CL21B475KOFNFN#
107	1.35	16	X7R	4.7uF	±10%	CL21B475KOFZFN#
108	1.35	16	X7R	220nF	±10%	CL21B224KOFNNN#
109	1.35	16	X7R	470nF	±10%	CL21B474KOFNFN#
110	1.35	16	X7R	470nF	±10%	CL21B474KOFNNN#
111	1.35	16	X7R	680nF	±10%	CL21B684KOFNFN#
112	1.35	16	X7R	680nF	±5%	CL21B684JOFNNN#
113	1.35	25	X7R	1uF	±10%	CL21B105KAFN3N#
114	1.35	25	X7R	1uF	±10%	CL21B105KAFNFN#
115	1.35	25	X7R	1uF	±10%	CL21B105KAFNNN#
116	1.35	25	X7R	1uF	±10%	CL21B105KAFSFN#
117	1.35	25	X7R	1uF	±20%	CL21B105MAFNNN#
118	1.35	25	X7R	1.5uF	±10%	CL21B155KAFNFN#
119	1.35	25	X7R	2.2uF	±10%	CL21B225KAFNFN#
120	1.35	25	X7R	2.2uF	±10%	CL21B225KAFZNN#
121	1.35	25	X7R	2.2uF	±20%	CL21B225MAFNNN#
122	1.35	25	X7R	3.3uF	±10%	CL21B335KAFNFN#
123	1.35	25	X7R	4.7uF	±10%	CL21B475KAFNFN#
124	1.35	25	X7R	4.7uF	±10%	CL21B475KAFNNN#
125	1.35	25	X7R	4.7uF	±10%	CL21B475KAFZF6#
126	1.35	25	X7R	4.7uF	±10%	CL21B475KAFZFN#
127	1.35	25	X7R	4.7uF	±20%	CL21B475MAFNNN#
128	1.35	25	X7R	100nF	±10%	CL21B104KAFNNN#
129	1.35	25	X7R	220nF	±10%	CL21B224KAFNFN#
130	1.35	25	X7R	220nF	±10%	CL21B224KAFNNN#
131	1.35	25	X7R	220nF	±20%	CL21B224MAFNNN#
132	1.35	25	X7R	220nF	±5%	CL21B224JAFNNN#
133	1.35	25	X7R	470nF	±10%	CL21B474KAFNFN#
134	1.35	25	X7R	470nF	±10%	CL21B474KAFNNN#
135	1.35	25	X7R	470nF	±10%	CL21B474KAFSFN#



# Normal Capacitors\_Standard

Size Code (inch/mm) : 0805/2012

No.	Thickness Max. (mm)	Rated Voltage (Vdc)	TCC	Capacitance	Capacitance Tolerance	Part Number
136	1.35	25	X7R	470nF	±20%	CL21B474MAFNNN#
137	1.35	25	X7R	470nF	±5%	CL21B474JAFNNN#
138	1.35	50	X7R	1uF	±10%	CL21B105KBFN3T#
139	1.35	50	X7R	1uF	±10%	CL21B105KBFNFN#
140	1.35	50	X7R	1uF	±10%	CL21B105KBFNNN#
141	1.35	50	X7R	1uF	±10%	CL21B105KBFNFN#
142	1.35	50	X7R	1uF	±10%	CL21B105KBFZFN#
143	1.35	50	X7R	1uF	±20%	CL21B105MBFNNN#
144	1.35	50	X7R	68nF	±10%	CL21B683KBFNNN#
145	1.35	50	X7R	82nF	±10%	CL21B823KBFNNN#
146	1.35	50	X7R	100nF	±10%	CL21B104KBFNNN#
147	1.35	50	X7R	100nF	±20%	CL21B104MBFNNN#
148	1.35	50	X7R	120nF	±10%	CL21B124KBFNNN#
149	1.35	50	X7R	150nF	±10%	CL21B154KBFNFN#
150	1.35	50	X7R	150nF	±10%	CL21B154KBFNNN#
151	1.35	50	X7R	220nF	±10%	CL21B224KBFNFN#
152	1.35	50	X7R	220nF	±10%	CL21B224KBFNNN#
153	1.35	50	X7R	330nF	±10%	CL21B334KBFNFN#
154	1.35	50	X7R	330nF	±10%	CL21B334KBFNNN#
155	1.35	50	X7R	330nF	±20%	CL21B334MBFNNN#
156	1.35	50	X7R	470nF	±10%	CL21B474KBFNFN#
157	1.35	50	X7R	470nF	±10%	CL21B474KBFNNN#
158	1.35	50	X7R	680nF	±10%	CL21B684KBFNNN#
159	1.35	100	X7R	22nF	±10%	CL21B223KCFNNN#
160	1.35	100	X7R	33nF	±10%	CL21B333KCFNNN#
161	1.35	100	X7R	47nF	±10%	CL21B473KCFNNN#
162	1.35	100	X7R	68nF	±10%	CL21B683KCFNNN#
163	1.35	100	X7R	100nF	±10%	CL21B104KCFNNN#
164	1.35	100	X7R	100nF	±10%	CL21B104KCFNFN#
165	1.35	100	X7R	220nF	±10%	CL21B224KCFNFN#
166	1.35	250	X7R	4.7nF	±10%	CL21B472KEFNNN#
167	1.35	250	X7R	10nF	±10%	CL21B103KEFNNN#
168	1.40	6.3	X7R	10uF	±10%	CL21B106KQQNFN#
169	1.40	6.3	X7R	10uF	±10%	CL21B106KQQNNN#
170	1.40	10	X7R	10uF	±10%	CL21B106KPQNFN#
171	1.40	10	X7R	10uF	±10%	CL21B106KPQNNN#
172	1.40	16	X7R	10uF	±10%	CL21B106KQQNFN#
173	1.40	16	X7R	10uF	±10%	CL21B106KQQNNN#

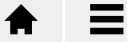

# Normal Capacitors\_Standard

Size Code (inch/mm) : 1206/3216

No.	Thickness Max. (mm)	Rated Voltage (Vdc)	TCC	Capacitance	Capacitance Tolerance	Part Number
1	1.00	10	X7R	1.2uF	±10%	CL31B125KPCNNN#
2	1.00	16	X7R	330nF	±10%	CL31B334KOCNNN#
3	1.00	16	X7R	470nF	±10%	CL31B474KOCNNN#
4	1.00	16	X7R	680nF	±10%	CL31B684KOCNNN#
5	1.00	25	X7R	220nF	±10%	CL31B224KACNFN#
6	1.00	25	X7R	220nF	±10%	CL31B224KACNNN#
7	1.00	25	X7R	330nF	±10%	CL31B334KACNNN#
8	1.00	50	X7R	1nF	±10%	CL31B102KBCNNN#
9	1.00	50	X7R	1.5nF	±10%	CL31B152KBCNNN#
10	1.00	50	X7R	2.7nF	±10%	CL31B272KBCNNN#
11	1.00	50	X7R	3.3nF	±10%	CL31B332KBCNNN#
12	1.00	50	X7R	6.8nF	±10%	CL31B682KBCNNN#
13	1.00	50	X7R	8.2nF	±10%	CL31B822KBCNNN#
14	1.00	50	X7R	10nF	±10%	CL31B103KBCNFN#
15	1.00	50	X7R	10nF	±20%	CL31B103MBCNNN#
16	1.00	50	X7R	33nF	±5%	CL31B333JBCNNN#
17	1.00	50	X7R	47nF	±10%	CL31B473KBCNNN#
18	1.00	50	X7R	47nF	±5%	CL31B473JBCNNN#
19	1.00	50	X7R	68nF	±10%	CL31B683KBCNNN#
20	1.00	50	X7R	100nF	±10%	CL31B104KBCNFN#
21	1.00	50	X7R	100nF	±10%	CL31B104KBCNNN#
22	1.00	50	X7R	100nF	±20%	CL31B104MBCNNN#
23	1.00	50	X7R	150nF	±10%	CL31B154KBCNNN#
24	1.00	50	X7R	220pF	±10%	CL31B221KBCNNN#
25	1.00	50	X7R	330pF	±10%	CL31B331KBCNNN#
26	1.00	50	X7R	390pF	±5%	CL31B391JBCNNN#
27	1.00	50	X7R	560pF	±10%	CL31B561KBCNNN#
28	1.00	50	X7R	680pF	±10%	CL31B681KBCNNN#
29	1.00	100	X7R	2.2nF	±10%	CL31B222KCCNNN#
30	1.00	100	X7R	3.3nF	±10%	CL31B332KCCNNN#
31	1.00	100	X7R	10nF	±10%	CL31B103KCCNFN#
32	1.00	100	X7R	15nF	±10%	CL31B153KCCNNN#
33	1.00	100	X7R	22nF	±10%	CL31B223KCCNFN#
34	1.00	100	X7R	22nF	±10%	CL31B223KCCNNN#
35	1.00	100	X7R	33nF	±10%	CL31B333KCCNNN#
36	1.00	200	X7R	1nF	±10%	CL31B102KDCNNN#
37	1.00	200	X7R	2.2nF	±10%	CL31B222KDCNFN#
38	1.00	200	X7R	10nF	±10%	CL31B103KDCNFN#
39	1.00	200	X7R	470pF	±10%	CL31B471KDCNNN#
40	1.25	25	X7R	1uF	±10%	CL31B105KAPLNN#
41	1.25	350	X7R	33nF	±10%	CL31B333KFESNN#
42	1.40	16	X7R	1uF	±10%	CL31B105KOFNFN#
43	1.40	16	X7R	1uF	±10%	CL31B105KOFNNN#
44	1.40	16	X7R	1uF	±20%	CL31B105MOFNNN#
45	1.40	16	X7R	1.5uF	±10%	CL31B155KOFNNN#



# Normal Capacitors\_Standard

Size Code (inch/mm) : 1206/3216

No.	Thickness Max. (mm)	Rated Voltage (Vdc)	TCC	Capacitance	Capacitance Tolerance	Part Number
46	1.40	50	X7R	220nF	±10%	CL31B224KBFNFN#
47	1.40	50	X7R	220nF	±10%	CL31B224KBFNNN#
48	1.40	50	X7R	220nF	±20%	CL31B224MBFNNN#
49	1.40	50	X7R	270nF	±10%	CL31B274KBFNNN#
50	1.40	50	X7R	330nF	±10%	CL31B334KBFNFN#
51	1.40	50	X7R	330nF	±10%	CL31B334KBFNNN#
52	1.40	50	X7R	330nF	±5%	CL31B334JBFNNN#
53	1.40	100	X7R	100nF	±10%	CL31B104KCFNFN#
54	1.40	100	X7R	100nF	±10%	CL31B104KCFNNN#
55	1.40	100	X7R	100nF	±5%	CL31B104JCFNNN#
56	1.40	200	X7R	33nF	±10%	CL31B333KDFNNN#
57	1.40	500	X7R	1nF	±10%	CL31B102KGFNFN#
58	1.40	500	X7R	1nF	±10%	CL31B102KGFNNN#
59	1.40	500	X7R	1.5nF	±10%	CL31B152KGFNFN#
60	1.40	500	X7R	1.5nF	±10%	CL31B152KGFNNN#
61	1.40	500	X7R	2.2nF	±10%	CL31B222KGFNFN#
62	1.40	500	X7R	3.3nF	±10%	CL31B332KGFNFN#
63	1.40	500	X7R	4.7nF	±10%	CL31B472KGFNFN#
64	1.40	500	X7R	6.8nF	±10%	CL31B682KGFNNN#
65	1.40	500	X7R	10nF	±10%	CL31B103KGFNFN#
66	1.40	500	X7R	220pF	±10%	CL31B221KGFNNN#
67	1.40	500	X7R	470pF	±10%	CL31B471KGFNNN#
68	1.40	500	X7R	680pF	±10%	CL31B681KGFNNN#
69	1.40	630	X7R	1nF	±10%	CL31B102KHFNFN#
70	1.40	630	X7R	1nF	±10%	CL31B102KHFSFN#
71	1.40	630	X7R	1.5nF	±10%	CL31B152KHFNFN#
72	1.40	630	X7R	2.2nF	±10%	CL31B222KHFNFN#
73	1.40	630	X7R	2.2nF	±10%	CL31B222KHFSFN#
74	1.40	630	X7R	3.3nF	±10%	CL31B332KHFSFN#
75	1.40	630	X7R	4.7nF	±10%	CL31B472KHFNFN#
76	1.40	630	X7R	4.7nF	±10%	CL31B472KHFNNN#
77	1.40	630	X7R	4.7nF	±10%	CL31B472KHFSFN#
78	1.40	630	X7R	6.8nF	±10%	CL31B682KHFNFN#
79	1.40	630	X7R	10nF	±10%	CL31B103KHFNFN#
80	1.40	630	X7R	10nF	±10%	CL31B103KHFNNN#
81	1.40	630	X7R	10nF	±10%	CL31B103KHFSFN#
82	1.40	630	X7R	330pF	±10%	CL31B331KHFNNN#
83	1.40	630	X7R	470pF	±10%	CL31B471KHFNNN#
84	1.40	630	X7R	680pF	±10%	CL31B681KHFNNN#
85	1.40	1000	X7R	1nF	±10%	CL31B102KIFNFN#
86	1.40	1000	X7R	1nF	±10%	CL31B102KIFNNN#
87	1.40	1000	X7R	1.5nF	±10%	CL31B152KIFNFN#
88	1.40	1000	X7R	2.2nF	±10%	CL31B222KIFNFN#
89	1.40	1000	X7R	2.2nF	±10%	CL31B222KIFNNN#
90	1.40	1000	X7R	680pF	±10%	CL31B681KIFNNN#



# Normal Capacitors\_Standard

Size Code (inch/mm) : 1206/3216

No.	Thickness Max. (mm)	Rated Voltage (Vdc)	TCC	Capacitance	Capacitance Tolerance	Part Number
91	1.80	6.3	X7R	10uF	±10%	CL31B106KQHNFN#
92	1.80	6.3	X7R	10uF	±10%	CL31B106KQHNNN#
93	1.80	6.3	X7R	22uF	±10%	CL31B226KQHNNN#
94	1.80	10	X7R	4.7uF	±10%	CL31B475KPHNFN#
95	1.80	10	X7R	4.7uF	±10%	CL31B475KPHNNN#
96	1.80	10	X7R	10uF	±10%	CL31B106KPHN3N#
97	1.80	10	X7R	10uF	±10%	CL31B106KPHNFN#
98	1.80	10	X7R	10uF	±10%	CL31B106KPHNNN#
99	1.80	10	X7R	22uF	±10%	CL31B226KPHNFN#
100	1.80	10	X7R	22uF	±10%	CL31B226KPHNNN#
101	1.80	10	X7R	22uF	±20%	CL31B226MPHNNN#
102	1.80	16	X7R	2.2uF	±10%	CL31B225KOHNFN#
103	1.80	16	X7R	2.2uF	±10%	CL31B225KOHNNN#
104	1.80	16	X7R	2.2uF	±20%	CL31B225MOHNNN#
105	1.80	16	X7R	3.3uF	±10%	CL31B335KOHNFN#
106	1.80	16	X7R	3.3uF	±10%	CL31B335KOHNNN#
107	1.80	16	X7R	4.7uF	±10%	CL31B475KOHNFN#
108	1.80	16	X7R	4.7uF	±10%	CL31B475KOHNNN#
109	1.80	16	X7R	10uF	±10%	CL31B106KOHNFN#
110	1.80	16	X7R	10uF	±10%	CL31B106KOHNNN#
111	1.80	16	X7R	10uF	±10%	CL31B106KOHZFN#
112	1.80	16	X7R	10uF	±20%	CL31B106MOHNNN#
113	1.80	25	X7R	1uF	±10%	CL31B105KAHNFN#
114	1.80	25	X7R	1uF	±10%	CL31B105KAHNNN#
115	1.80	25	X7R	1uF	±20%	CL31B105MAHNNN#
116	1.80	25	X7R	1uF	±5%	CL31B105JAHNNN#
117	1.80	25	X7R	2.2uF	±10%	CL31B225KAHNFN#
118	1.80	25	X7R	2.2uF	±10%	CL31B225KAHNNN#
119	1.80	25	X7R	4.7uF	±10%	CL31B475KAHNFN#
120	1.80	25	X7R	4.7uF	±10%	CL31B475KAHNNN#
121	1.80	25	X7R	10uF	±10%	CL31B106KAHNFN#
122	1.80	25	X7R	10uF	±10%	CL31B106KAHNNN#
123	1.80	25	X7R	10uF	±10%	CL31B106KAHSFN#
124	1.80	25	X7R	680nF	±10%	CL31B684KAHNNN#
125	1.80	35	X7R	10uF	±10%	CL31B106KLHNFN#
126	1.80	35	X7R	10uF	±10%	CL31B106KLHNNN#
127	1.80	35	X7R	10uF	±10%	CL31B106KLHSFN#
128	1.80	50	X7R	1uF	±10%	CL31B105KBHNFN#
129	1.80	50	X7R	1uF	±10%	CL31B105KBHNNN#
130	1.80	50	X7R	1uF	±10%	CL31B105KBHSNN#
131	1.80	50	X7R	2.2uF	±10%	CL31B225KBHNFN#
132	1.80	50	X7R	2.2uF	±10%	CL31B225KBHNNN#
133	1.80	50	X7R	4.7uF	±10%	CL31B475KBHNN3N#
134	1.80	50	X7R	4.7uF	±10%	CL31B475KBHNFN#
135	1.80	50	X7R	4.7uF	±10%	CL31B475KBHNNN#



# Normal Capacitors\_Standard

Size Code (inch/mm) : 1206/3216

No.	Thickness Max. (mm)	Rated Voltage (Vdc)	TCC	Capacitance	Capacitance Tolerance	Part Number
136	1.80	50	X7R	4.7uF	±10%	CL31B475KBHZFN#
137	1.80	50	X7R	10uF	±10%	CL31B106KBHNFN#
138	1.80	50	X7R	10uF	±10%	CL31B106KBHNNN#
139	1.80	50	X7R	470nF	±10%	CL31B474KBHNFN#
140	1.80	50	X7R	470nF	±10%	CL31B474KBHNNN#
141	1.80	50	X7R	470nF	±20%	CL31B474MBHNNN#
142	1.80	100	X7R	1uF	±10%	CL31B105KCHNFN#
143	1.80	100	X7R	1uF	±10%	CL31B105KCHNNN#
144	1.80	100	X7R	1uF	±10%	CL31B105KCHSFN#
145	1.80	100	X7R	1uF	±10%	CL31B105KCHSNN#
146	1.80	100	X7R	2.2uF	±10%	CL31B225KCHSFN#
147	1.80	100	X7R	2.2uF	±10%	CL31B225KCHSNN#
148	1.80	100	X7R	470nF	±10%	CL31B474KCHSFN#
149	1.80	200	X7R	100nF	±10%	CL31B104KDHNFN#
150	1.80	250	X7R	33nF	±10%	CL31B333KEHNNN#
151	1.80	250	X7R	47nF	±10%	CL31B473KEHNNN#
152	1.80	250	X7R	47nF	±10%	CL31B473KEHSFN#
153	1.80	250	X7R	100nF	±10%	CL31B104KEHNFN#
154	1.80	250	X7R	100nF	±10%	CL31B104KEHNNN#
155	1.80	250	X7R	100nF	±10%	CL31B104KEHSFN#
156	1.80	500	X7R	22nF	±10%	CL31B223KGHNNN#
157	1.80	500	X7R	33nF	±10%	CL31B333KGHNFN#
158	1.80	500	X7R	33nF	±10%	CL31B333KGHNNN#
159	1.80	630	X7R	22nF	±10%	CL31B223KHNNFN#
160	1.80	630	X7R	22nF	±10%	CL31B223KHNNNN#
161	1.80	630	X7R	22nF	±10%	CL31B223KHHSFN#
162	1.80	630	X7R	33nF	±10%	CL31B333KHNNFN#
163	1.80	630	X7R	33nF	±10%	CL31B333KHHSFN#
164	1.80	2000	X7R	1nF	±10%	CL31B102KJHNNN#



# Normal Capacitors\_Standard

Size Code (inch/mm) : 1210/3225

No.	Thickness Max. (mm)	Rated Voltage (Vdc)	TCC	Capacitance	Capacitance Tolerance	Part Number
1	1.45	25	X7R	1uF	±10%	CL32B105KAFNNN#
2	1.45	50	X7R	150nF	±10%	CL32B154KBFNNN#
3	1.45	50	X7R	470nF	±10%	CL32B474KBFNNN#
4	1.45	500	X7R	10nF	±10%	CL32B103KGFNNN#
5	1.80	50	X7R	1uF	±10%	CL32B105KBHNNN#
6	1.80	50	X7R	1uF	±20%	CL32B105MBHNNN#
7	2.00	16	X7R	10uF	±10%	CL32B106KOULNN#
8	2.00	25	X7R	10uF	±10%	CL32B106KAUL3N#
9	2.00	25	X7R	10uF	±10%	CL32B106KAULNN#
10	2.00	35	X7R	10uF	±10%	CL32B106KLULNN#
11	2.00	50	X7R	4.7uF	±10%	CL32B475KBUYFN#
12	2.00	50	X7R	4.7uF	±10%	CL32B475KBUYNN#
13	2.20	10	X7R	10uF	±10%	CL32B106KPINNN#
14	2.20	25	X7R	2.2uF	±10%	CL32B225KAINNN#
15	2.70	10	X7R	22uF	±10%	CL32B226KPJNNN#
16	2.70	10	X7R	47uF	±10%	CL32B476KPJNNN#
17	2.70	10	X7R	47uF	±20%	CL32B476MPJNNN#
18	2.70	100	X7R	1uF	±10%	CL32B105KCJNNN#
19	2.70	100	X7R	1uF	±10%	CL32B105KCJSNN#
20	2.70	100	X7R	2.2uF	±10%	CL32B225KCJSFN#
21	2.70	100	X7R	2.2uF	±10%	CL32B225KCJSNN#
22	2.70	16	X7R	10uF	±10%	CL32B106KOJNNN#
23	2.70	16	X7R	22uF	±10%	CL32B226KOJNFN#
24	2.70	16	X7R	22uF	±10%	CL32B226KOJNNN#
25	2.70	16	X7R	22uF	±20%	CL32B226MOJNNN#
26	2.70	25	X7R	10uF	±10%	CL32B106KAJNFN#
27	2.70	25	X7R	10uF	±10%	CL32B106KAJNNN#
28	2.70	25	X7R	22uF	±10%	CL32B226KAJNFN#
29	2.70	25	X7R	22uF	±10%	CL32B226KAJNNN#
30	2.70	250	X7R	100nF	±10%	CL32B104KEJNNN#
31	2.70	35	X7R	10uF	±10%	CL32B106KLJNNN#
32	2.70	50	X7R	2.2uF	±10%	CL32B225KBJNNN#
33	2.70	50	X7R	4.7uF	±10%	CL32B475KBJN3N#
34	2.70	50	X7R	4.7uF	±10%	CL32B475KBJNFN#
35	2.70	50	X7R	4.7uF	±10%	CL32B475KBJNNN#
36	2.70	50	X7R	10uF	±10%	CL32B106KBJNFN#
37	2.70	50	X7R	10uF	±10%	CL32B106KBJNNN#
38	2.70	6.3	X7R	47uF	±20%	CL32B476MQJNNN#
39	2.80	50	X7R	4.7uF	±10%	CL32B475KBVZNN#



# Normal Capacitors\_Standard

## Product Lineup (X7S)

Size Code (inch/mm) : 0201/0603

No.	Thickness Max. (mm)	Rated Voltage (Vdc)	TCC	Capacitance	Capacitance Tolerance	Part Number
1	0.33	10	X7S	100nF	±10%	CL03Y104KP3NNN#
2	0.33	16	X7S	100nF	±10%	CL03Y104K03NNN#

Size Code (inch/mm) : 0603/1608

No.	Thickness Max. (mm)	Rated Voltage (Vdc)	TCC	Capacitance	Capacitance Tolerance	Part Number
1	1.00	6.3	X7S	10uF	±20%	CL10Y106MQ8NFR#

Size Code (inch/mm) : 0805/2012

No.	Thickness Max. (mm)	Rated Voltage (Vdc)	TCC	Capacitance	Capacitance Tolerance	Part Number
1	1.35	25	X7S	4.7uF	±10%	CL21Y475KAFNNN#

## Product Lineup (X7T)

Size Code (inch/mm) : 0201/0603

No.	Thickness Max. (mm)	Rated Voltage (Vdc)	TCC	Capacitance	Capacitance Tolerance	Part Number
1	0.33	6.3	X7T	220nF	±10%	CL03Z224KQ3NNN#

Size Code (inch/mm) : 0402/1005

No.	Thickness Max. (mm)	Rated Voltage (Vdc)	TCC	Capacitance	Capacitance Tolerance	Part Number
1	0.70	4	X7T	10uF	±20%	CL05Z106MR5NUN#

Size Code (inch/mm) : 0805/2012

No.	Thickness Max. (mm)	Rated Voltage (Vdc)	TCC	Capacitance	Capacitance Tolerance	Part Number
1	1.40	6.3	X7T	22uF	±20%	CL21Z226MQQNNN#
2	1.45	25	X7T	10uF	±10%	CL21Z106KAYQNN#

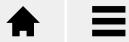

# Normal Capacitors\_Standard

## Product Lineup (X7R(S) (DC Bias 0.5vr TCC))

Size Code (inch/mm) : 0603/1608

No.	Thickness Max. (mm)	Rated Voltage (Vdc)	TCC	Capacitance	Capacitance Tolerance	Part Number	Remarks
1	1.00	16	X7R(S) (DC Bias 0.5vr TCC)	10uF	±20%	CL10K106M08NRN#	

Size Code (inch/mm) : 0805/2012

No.	Thickness Max. (mm)	Rated Voltage (Vdc)	TCC	Capacitance	Capacitance Tolerance	Part Number	Remarks
1	1.45	25	X7R(S) (DC Bias 0.5vr TCC)	10uF	±10%	CL21K106KAYQNN#	

Size Code (inch/mm) : 0805/2012

No.	Thickness Max. (mm)	Rated Voltage (Vdc)	TCC	Capacitance	Capacitance Tolerance	Part Number	Remarks
1	1.45	25	X7R(S) (DC Bias 0.5vr TCC)	10uF	±10%	CL21K106KAY6NN#	Normal(Epoxy)

## Product Lineup (X7S)

Size Code (inch/mm) : 1206/3216

No.	Thickness Max. (mm)	Rated Voltage (Vdc)	TCC	Capacitance	Capacitance Tolerance	Part Number	Remarks
1	1.90	100	X7S	4.7uF	±10%	CL31Y475KCK6NN#	Normal(Epoxy)

# Normal Capacitors\_High Level I

Normal High Level I

## Features

- A High level I MLCC is a chip-type capacitor suitable for industrial applications, with greater reliability than a general MLCC
- It has improved the moisture resistance characteristics.
- In the outgoing inspection, proceed with the bending strength evaluation strengthen.

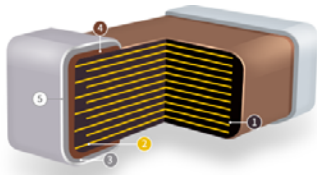

- ① Ceramic Body
- ② Electrode (Ni/Cu\*)
- ③ Plating (Ni)
- ④ Termination (Cu or Cu+Metal Epoxy)
- ⑤ Plating (Sn)

High Level I

Improved Reliability  
 (65°C, 90%RH, 1Vr, 500H)

High Level II

Reinforced Reliability  
 (85°C, 85%RH, 1Vr, 1000H)

\* Internal Cu electrode is only applied to limited products.

## Application

- Server, Network, Base station, Solar Inverter, DC-DC Converter

## Structure and Dimensions

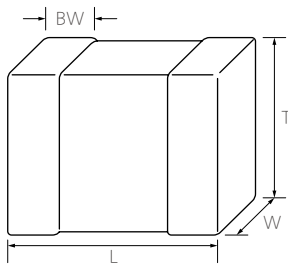

Size Code	Dimension (mm)				EIA (inch)
	L	W	T	BW	
03	0.60±0.03	0.30±0.03	0.30±0.03	0.15±0.05	0603
	0.60±0.09	0.30±0.09	0.30±0.09		
05	1.00±0.05	0.50±0.05	0.50±0.05	0.25±0.10	0402
	1.00±0.10	0.50±0.10	0.50±0.10		
	1.00±0.15	0.50±0.15	0.50±0.15		
	1.00±0.20	0.50±0.20	0.50±0.20		
10	1.60±0.10	0.80±0.10	0.80±0.10	0.30±0.20	0603
	1.60±0.15	0.80±0.15	0.80±0.15		
	1.60±0.20	0.80±0.20	0.80±0.20		
	1.60±0.25	0.80±0.25	0.80±0.25		
21	2.00±0.10	1.25±0.10	0.65±0.10	0.5+0.2/-0.3	0805
	2.00±0.10	1.25±0.10	0.85±0.10		
	2.00±0.10	1.25±0.10	1.25±0.10		
	2.00±0.15	1.25±0.15	1.25±0.15		
	2.00±0.20	1.25±0.20	1.25±0.20		
31	3.20±0.15	1.60±0.15	0.85±0.15	0.50±0.30	1206
	3.20±0.15	1.60±0.15	1.25±0.15		
	3.20±0.20	1.60±0.20	1.60±0.20		
	3.20±0.30	1.60±0.20	1.60±0.20		
	3.20±0.30	1.60±0.30	1.60±0.30		
32	3.20±0.30	2.50±0.20	1.80±0.20	0.60±0.30	1210
	3.20±0.30	2.50±0.20	2.00±0.20		
	3.20±0.30	2.50±0.20	2.50±0.20		
	3.20±0.40	2.50±0.30	2.50±0.30		

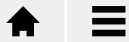

# Normal Capacitors\_High Level I

## Capacitance Table (COG)

Category	TCC	Size Code (inch/mm)	Rated Voltage (Vdc)	Capacitance									Capacitance Range				
				pF			nF			uF							
				0.1	1	10	100	1	10	100	1	10		100			
High Level I	COG (125°C)	008004/0201	16	█	█	█										0.2pF - 10pF	
			25	█	█	█											0.2pF - 10pF
		01005/0402	6.3				█										100pF - 100pF
			16				█	█									10pF - 100pF
			25				█	█									10pF - 100pF
		0201/0603	50				█										100pF - 100pF
			25	█	█	█	█										0.2pF - 100pF
		0402/1005	50	█	█	█	█										0.5pF - 47pF
			16				█	█	█								27pF - 1nF
		0603/1608	25	█	█	█	█										0.1pF - 1nF
			50	█	█	█	█										0.1pF - 1nF
			100				█	█									12pF - 220pF
			16							█							1nF - 2.2nF
		0805/2012	25								█	█					560pF - 10nF
			50								█	█					1pF - 5.6nF
			100								█	█					1.2pF - 4.7nF
			200										█				220pF - 220pF
			250											█			470pF - 470pF
			25												█	█	3.3nF - 10nF
		1206/3216	50													█	10pF - 15nF
			100													█	12pF - 3.9nF
			200													█	18pF - 1nF
			250													█	10pF - 2.2nF
			630													█	10pF - 470pF
			16													█	15nF - 120nF
			25													█	10nF - 100nF
			50													█	10pF - 100nF
			100													█	20pF - 33nF
			200													█	68pF - 1nF
		1210/3225	250													█	2.2nF - 8.2nF
			500													█	10pF - 2.2nF
			630													█	10pF - 10nF
			1000													█	10pF - 1nF
			2000													█	15pF - 100pF
			25													█	10nF - 10nF
			50													█	1.8nF - 22nF
			100													█	33nF - 47nF
		500													█	680pF - 1.8nF	
		630													█	8.2nF - 33nF	
		1000													█	10nF - 22nF	
2000													█	100pF - 100pF			



# Normal Capacitors\_High Level I

## Capacitance Table (X5R)

Category	TCC	Size Code (inch/mm)	Rated Voltage (Vdc)	Capacitance									Capacitance Range				
				pF			nF			uF							
				0.1	1	10	100	1	10	100	1	10		100			
High Level I	X5R (85°C)	008004/0201	6.3													10nF - 10nF	
			4														100nF - 100nF
		01005/0402	6.3														1nF - 100nF
			10														1nF - 10nF
			25														10nF - 10nF
		0201/0603	4														220nF - 220nF
			6.3														2.2nF - 2.2uF
			10														1.5nF - 220nF
			16														1.2nF - 100nF
			25														100pF - 100nF
			35														100nF - 100nF
		0402/1005	2.5														4.7uF - 4.7uF
			4														680nF - 22uF
			6.3														1nF - 10uF
			10														1nF - 10uF
			16														1nF - 2.2uF
			25														1nF - 2.2uF
		0603/1608	35														1uF - 1uF
			50														1nF - 100nF
			4														4.7uF - 47uF
			6.3														330nF - 22uF
			10														150nF - 22uF
			16														220nF - 10uF
		0805/2012	25														100nF - 10uF
			35														1uF - 4.7uF
			50														220nF - 2.2uF
			2.5														100uF - 100uF
			4														22uF - 100uF
			6.3														1.5uF - 100uF
		1206/3216	10														330nF - 47uF
			16														330nF - 22uF
			25														470nF - 22uF
			35														4.7uF - 4.7uF
			50														1uF - 4.7uF
		1210/3225	100														18nF - 18nF
			4														100uF - 100uF
			6.3														4.7uF - 100uF
			10														1uF - 100uF
			16														680nF - 22uF
			25														1uF - 22uF
		1210/3225	35														4.7uF - 4.7uF
			50														1uF - 10uF
			6.3														22uF - 220uF
			10														10uF - 100uF
			16														4.7uF - 47uF
		1210/3225	25														4.7uF - 22uF
			35														4.7uF - 10uF
50															1uF - 10uF		

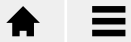

# Normal Capacitors\_High Level I

## Capacitance Table (X6S)

Category	TCC	Size Code (inch/mm)	Rated Voltage (Vdc)	Capacitance												Capacitance Range			
				pF				nF				uF							
				0.1	1	10	100	1	10	100	1	10	100	1000					
High Level I	X6S (105°C)	01005/0402	6.3														10nF - 10nF		
			4															15nF - 1uF	
		0201/0603	6																15nF - 1uF
			10																100nF - 1uF
			16																100nF - 100nF
			25																100nF - 100nF
		0402/1005	2.5																2.2uF - 22uF
			4																100nF - 22uF
			6.3																150nF - 10uF
			10																150nF - 2.2uF
			16																470nF - 2.2uF
			25																68nF - 2.2uF
			35																220nF - 220nF
		0603/1608	2.5																4.7uF - 47uF
			4																1uF - 47uF
			6.3																1uF - 22uF
			10																1uF - 10uF
			16																470nF - 10uF
			25																470nF - 4.7uF
			35																2.2uF - 2.2uF
		0805/2012	50																1uF - 1uF
			2.5																22uF - 100uF
			4																10uF - 100uF
			6.3																4.7uF - 47uF
			10																4.7uF - 22uF
			16																1uF - 22uF
			25																4.7uF - 22uF
		1206/3216	35																1uF - 1uF
			50																4.7uF - 4.7uF
			4																47uF - 100uF
			6.3																22uF - 100uF
			10																22uF - 22uF
		1210/3225	16																4.7uF - 22uF
			25																10uF - 22uF
			4																100uF - 100uF
			6.3																47uF - 100uF
			10																22uF - 47uF
			16																47uF - 47uF
			25																10uF - 10uF
			35																10uF - 10uF

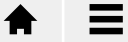

# Normal Capacitors\_High Level I

## Capacitance Table (X7R)

Category	TCC	Size Code (inch/mm)	Rated Voltage (Vdc)	Capacitance									Capacitance Range				
				pF			nF			uF							
				0.1	1	10	100	1	10	100	1	10		100			
High Level I	X7R (125°C)	01005/0402	10				█								100pF - 1nF		
			16				█									330pF - 330pF	
		0201/0603	6							█							1.5nF - 10nF
			10							█							330pF - 100nF
			16							█							100pF - 10nF
		0402/1005	25							█							100pF - 10nF
			4													█	1uF - 1uF
			6													█	1nF - 1uF
			10													█	10nF - 470nF
		0603/1608	16													█	820pF - 220nF
			25													█	220pF - 220nF
			50													█	150pF - 100nF
			6													█	220nF - 4.7uF
		0805/2012	10													█	5.6nF - 2.2uF
			16													█	5.6nF - 1uF
			25													█	4.7nF - 1uF
			35													█	470nF - 470nF
			50													█	100pF - 1uF
			100													█	220pF - 100nF
		1206/3216	6													█	2.2uF - 10uF
			10													█	220nF - 10uF
			16													█	100nF - 10uF
			25													█	1nF - 4.7uF
			50													█	100pF - 2.2uF
			100													█	220pF - 470nF
			200													█	150pF - 10nF
		250													█	1nF - 10nF	
		1206/3216	6													█	22uF - 22uF
			10													█	1uF - 22uF
			16													█	220nF - 10uF
			25													█	220nF - 10uF
			35													█	10uF - 10uF
50														█	220pF - 10uF		
100														█	220pF - 2.2uF		
200														█	470pF - 100nF		
250														█	33nF - 100nF		
350														█	33nF - 33nF		
500														█	220pF - 33nF		
630														█	330pF - 33nF		
1000													█	680pF - 10nF			
2000													█	1nF - 1nF			

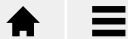

# Normal Capacitors\_High Level I

Category	TCC	Size Code (inch/mm)	Rated Voltage (Vdc)	Capacitance									Capacitance Range	
				pF			nF			uF				
				0.1	1	10	100	1	10	100	1	10		100
High Level I	X7R (125°C)	1210/3225	6										47uF - 47uF	
			10										10uF - 47uF	
			16										2.2uF - 22uF	
			25										1uF - 22uF	
			35										10uF - 10uF	
			50										150nF - 10uF	
			100										220nF - 4.7uF	
			200										22nF - 22nF	
			250										100nF - 100nF	
			500										10nF - 22nF	
			630										22nF - 47nF	
			1000										22nF - 22nF	
2000										1nF - 1nF				
High Level I	X7S (125°C)	0201/0603	6										100nF - 100nF	
			10										100nF - 100nF	
			16										100nF - 100nF	
		0402/1005	6											1uF - 1uF
			10											1uF - 1uF
			50											33nF - 100nF
		0603/1608	6											1uF - 1uF
			10											1uF - 1uF
			16											680nF - 4.7uF
		0805/2012	25											2.2uF - 2.2uF
			16											4.7uF - 10uF
			25											2.2uF - 10uF
		1206/3216	100											1uF - 1uF
			4											47uF - 47uF
		1210/3225	25											10uF - 10uF
4												100uF - 100uF		
6												100uF - 100uF		
25												22uF - 22uF		
50												10uF - 10uF		
100											4.7uF - 10uF			
High Level I	X7T (125°C)	01005/0402	2										470nF - 470nF	
			6										220nF - 220nF	
		0201/0603	10											10nF - 10nF
			2											100nF - 220nF
		0402/1005	4											10uF - 10uF
			10											2.2uF - 2.2uF
			16											2.2uF - 2.2uF
		0603/1608	6											4.7uF - 10uF
			10											1uF - 10uF
		0805/2012	6											22uF - 22uF
			10											22uF - 22uF
		1206/3216	35											10uF - 10uF
1210/3225	6											22uF - 47uF		



# Normal Capacitors\_High Level I

## Product Lineup (COG)

Size Code (inch/mm) : 0201/0603

No.	Thickness Max. (mm)	Rated Voltage (Vdc)	TCC	Capacitance	Capacitance Tolerance	Part Number
1	0.33	25	COG	10pF	±5%	CL03C100JA3NNW#
2	0.33	25	COG	33pF	±5%	CL03C330JA3NNW#
3	0.33	25	COG	100pF	±5%	CL03C101JA3NNW#
4	0.33	50	COG	33pF	±5%	CL03C330JB3NNW#
5	0.33	50	COG	47pF	±5%	CL03C470JB3NNW#

Size Code (inch/mm) : 0402/1005

No.	Thickness Max. (mm)	Rated Voltage (Vdc)	TCC	Capacitance	Capacitance Tolerance	Part Number
1	0.55	25	COG	100pF	±5%	CL05C101JA5NNW#
2	0.55	25	COG	220pF	±5%	CL05C221JA5NNW#
3	0.55	50	COG	0.5pF	±0.25pF	CL05C0R5CB5NNW#
4	0.55	50	COG	1.3pF	±0.25pF	CL05CR75CB5NNW#
5	0.55	50	COG	2pF	±0.25pF	CL05C1R3CB5NNW#
6	0.55	50	COG	2.2pF	±0.25pF	CL05C020CB5NNW#
7	0.55	50	COG	2.4pF	±0.1pF	CL05C2R2CB5NNW#
8	0.55	50	COG	4pF	±0.25pF	CL05C2R4BB5NNW#
9	0.55	50	COG	4.3pF	±0.25pF	CL05C040CB5NNW#
10	0.55	50	COG	4.7pF	±0.25pF	CL05C4R3CB5NNW#
11	0.55	50	COG	5.6pF	±0.25pF	CL05C4R7CB5NNW#
12	0.55	50	COG	0.75pF	±0.25pF	CL05C5R6CB5NNW#
13	0.55	50	COG	8.2pF	±0.25pF	CL05C8R2CB5NNW#
14	0.55	50	COG	9pF	±0.25pF	CL05C090CB5NNW#
15	0.55	50	COG	10pF	±5%	CL05C100JB5NNW#
16	0.55	50	COG	12pF	±0.25pF	CL05C120CB5NNW#
17	0.55	50	COG	12pF	±5%	CL05C120JB5NNW#
18	0.55	50	COG	15pF	±0.25pF	CL05C150CB5NNW#
19	0.55	50	COG	15pF	±5%	CL05C150JB5NNW#
20	0.55	50	COG	18pF	±1%	CL05C180FB5NNW#
21	0.55	50	COG	18pF	±5%	CL05C180JB5NNW#
22	0.55	50	COG	20pF	±5%	CL05C200JB5NNW#
23	0.55	50	COG	22pF	±5%	CL05C220JB5NNW#
24	0.55	50	COG	24pF	±5%	CL05C240JB5NNW#
25	0.55	50	COG	27pF	±5%	CL05C270JB5NNW#



# Normal Capacitors\_High Level I

Size Code (inch/mm) : 0402/1005

No.	Thickness Max. (mm)	Rated Voltage (Vdc)	TCC	Capacitance	Capacitance Tolerance	Part Number
26	0.55	50	COG	33pF	±5%	CL05C330JB5NNW#
27	0.55	50	COG	39pF	±5%	CL05C390JB5NNW#
28	0.55	50	COG	47pF	±1%	CL05C470FB5NNW#
29	0.55	50	COG	47pF	±5%	CL05C470JB5NNW#
30	0.55	50	COG	56pF	±5%	CL05C560JB5NNW#
31	0.55	50	COG	68pF	±5%	CL05C680JB5NNW#
32	0.55	50	COG	82pF	±5%	CL05C820JB5NNW#
33	0.55	50	COG	100pF	±1%	CL05C101FB5NNW#
34	0.55	50	COG	100pF	±5%	CL05C101JB5NNW#
35	0.55	50	COG	150pF	±5%	CL05C151JB5NNW#
36	0.55	50	COG	180pF	±5%	CL05C181JB5NNW#
37	0.55	50	COG	220pF	±5%	CL05C221JB5NNW#
38	0.55	50	COG	270pF	±5%	CL05C271JB5NNW#
39	0.55	50	COG	330pF	±5%	CL05C331JB5NNW#
40	0.55	50	COG	390pF	±5%	CL05C391JB5NNW#
41	0.55	50	COG	470pF	±5%	CL05C471JB5NNW#
42	0.55	50	COG	560pF	±5%	CL05C561JB5NNW#
43	0.55	50	COG	680pF	±5%	CL05C681JB5NNW#
44	0.55	50	COG	820pF	±5%	CL05C821JB5NNW#
45	0.55	50	COG	1nF	±5%	CL05C102JB5NNW#

Size Code (inch/mm) : 0603/1608

No.	Thickness Max. (mm)	Rated Voltage (Vdc)	TCC	Capacitance	Capacitance Tolerance	Part Number
1	0.90	25	COG	680pF	±5%	CL10C681JA8NNW#
2	0.90	25	COG	1.5nF	±2%	CL10C152GA8NNW#
3	0.90	50	COG	1pF	±0.25pF	CL10C010CB8NNW#
4	0.90	50	COG	1.8pF	±0.25pF	CL10C1R8CB8NNW#
5	0.90	50	COG	2.2pF	±0.1pF	CL10C2R2BB8NNW#
6	0.90	50	COG	2.2pF	±0.25pF	CL10C2R2CB8NNW#
7	0.90	50	COG	3.3pF	±0.25pF	CL10C3R3CB8NNW#
8	0.90	50	COG	3.9pF	±0.1pF	CL10C3R9BB8NNW#
9	0.90	50	COG	3.9pF	±0.25pF	CL10C3R9CB8NNW#
10	0.90	50	COG	4.7pF	±0.1pF	CL10C4R7BB8NNW#
11	0.90	50	COG	4.7pF	±0.25pF	CL10C4R7CB8NNW#
12	0.90	50	COG	5pF	±0.1pF	CL10C050BB8NNW#
13	0.90	50	COG	5.6pF	±0.25pF	CL10C5R6CB8NNW#
14	0.90	50	COG	6.2pF	±0.25pF	CL10C6R2CB8NNW#
15	0.90	50	COG	6.8pF	±0.25pF	CL10C6R8CB8NNW#
16	0.90	50	COG	8.2pF	±0.25pF	CL10C8R2CB8NNW#
17	0.90	50	COG	10pF	±0.25pF	CL10C100CB8NNW#
18	0.90	50	COG	10pF	±5%	CL10C100JB8NNW#
19	0.90	50	COG	10pF	±10%	CL10C100KB8NNW#
20	0.90	50	COG	12pF	±5%	CL10C120JB8NNW#



# Normal Capacitors\_High Level I

Size Code (inch/mm) : 0603/1608

No.	Thickness Max. (mm)	Rated Voltage (Vdc)	TCC	Capacitance	Capacitance Tolerance	Part Number
21	0.90	50	COG	15pF	±1%	CL10C150FB8NNW#
22	0.90	50	COG	15pF	±5%	CL10C150JB8NNW#
23	0.90	50	COG	18pF	±5%	CL10C180JB8NNW#
24	0.90	50	COG	22pF	±1%	CL10C220FB8NNW#
25	0.90	50	COG	22pF	±2%	CL10C220GB8NNW#
26	0.90	50	COG	22pF	±5%	CL10C220JB8NNW#
27	0.90	50	COG	33pF	±5%	CL10C330JB8NNW#
28	0.90	50	COG	39pF	±5%	CL10C390JB8NNW#
29	0.90	50	COG	47pF	±1%	CL10C470FB8NNW#
30	0.90	50	COG	47pF	±5%	CL10C470JB8NNW#
31	0.90	50	COG	47pF	±10%	CL10C470KB8NNW#
32	0.90	50	COG	56pF	±5%	CL10C560JB8NNW#
33	0.90	50	COG	68pF	±5%	CL10C680JB8NNW#
34	0.90	50	COG	82pF	±5%	CL10C820JB8NNW#
35	0.90	50	COG	100pF	±5%	CL10C101JB8NNW#
36	0.90	50	COG	100pF	±10%	CL10C101KB8NNW#
37	0.90	50	COG	120pF	±5%	CL10C121JB8NNW#
38	0.90	50	COG	150pF	±5%	CL10C151JB8NNW#
39	0.90	50	COG	180pF	±5%	CL10C181JB8NNW#
40	0.90	50	COG	200pF	±5%	CL10C201JB8NNW#
41	0.90	50	COG	220pF	±5%	CL10C221JB8NNW#
42	0.90	50	COG	270pF	±5%	CL10C271JB8NNW#
43	0.90	50	COG	330pF	±5%	CL10C331JB8NNW#
44	0.90	50	COG	390pF	±5%	CL10C391JB8NNW#
45	0.90	50	COG	470pF	±5%	CL10C471JB8NNW#
46	0.90	50	COG	560pF	±5%	CL10C561JB8NNW#
47	0.90	50	COG	680pF	±5%	CL10C681JB8NNW#
48	0.90	50	COG	820pF	±5%	CL10C821JB8NNW#
49	0.90	50	COG	1nF	±5%	CL10C102JB8NNW#
50	0.90	50	COG	1.2nF	±5%	CL10C122JB8NNW#
51	0.90	50	COG	1.5nF	±5%	CL10C152JB8NNW#
52	0.90	50	COG	2.2nF	±5%	CL10C222JB8NNW#
53	0.90	100	COG	10pF	±5%	CL10C100JC8NNW#
54	0.90	100	COG	33pF	±5%	CL10C330JC8NNW#
55	0.90	100	COG	100pF	±5%	CL10C101JC8NNW#
56	0.90	100	COG	150pF	±5%	CL10C151JC8NNW#
57	0.90	100	COG	220pF	±5%	CL10C221JC8NNW#
58	0.90	100	COG	270pF	±5%	CL10C271JC8NNW#
59	0.90	100	COG	330pF	±5%	CL10C331JC8NNW#

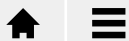

# Normal Capacitors\_High Level I

Size Code (inch/mm) : 0805/2012

No.	Thickness Max. (mm)	Rated Voltage (Vdc)	TCC	Capacitance	Capacitance Tolerance	Part Number
1	0.75	50	COG	33pF	±5%	CL21C330JBANNW#
2	0.75	50	COG	100pF	±2%	CL21C101GBANNW#
3	0.75	50	COG	100pF	±5%	CL21C101JBANNW#
4	0.75	50	COG	150pF	±5%	CL21C151JBANNW#
5	0.75	50	COG	220pF	±5%	CL21C221JBANNW#
6	0.75	50	COG	270pF	±5%	CL21C271JBANNW#
7	0.75	50	COG	330pF	±5%	CL21C331JBANNW#
8	0.75	50	COG	390pF	±5%	CL21C391JBANNW#
9	0.75	50	COG	470pF	±5%	CL21C471JBANNW#
10	0.75	50	COG	560pF	±5%	CL21C561JBANNW#
11	0.75	50	COG	680pF	±5%	CL21C681JBANNW#
12	0.95	50	COG	680pF	±5%	CL21C681JBCNNW#
13	0.95	50	COG	1nF	±5%	CL21C102JBCNNW#
14	1.35	50	COG	1.5nF	±5%	CL21C152JBFNNW#
15	1.35	50	COG	2.2nF	±5%	CL21C222JBFNNW#
16	1.35	50	COG	2.7nF	±5%	CL21C272JBFNNW#
17	1.35	50	COG	3.3nF	±5%	CL21C332JBFNNW#
18	1.35	50	COG	4.7nF	±5%	CL21C472JBFNNW#
19	1.35	50	COG	10nF	±5%	CL21C103JBFNNW#
20	0.75	100	COG	330pF	±5%	CL21C331JCANNW#
21	0.95	100	COG	470pF	±5%	CL21C471JCCNNW#
22	0.95	100	COG	680pF	±5%	CL21C681JCCNNW#
23	1.35	100	COG	1nF	±5%	CL21C102JCFNNW#
24	0.95	200	COG	220pF	±5%	CL21C221JDCNNW#
25	0.95	250	COG	10pF	±5%	CL21C100JECNNW#



# Normal Capacitors\_High Level I

Size Code (inch/mm) : 1206/3216, 1210/3225

No.	Thickness Max. (mm)	Rated Voltage (Vdc)	TCC	Capacitance	Capacitance Tolerance	Part Number
1	1.40	25	COG	10nF	±2%	CL31C103GAFNNW#
2	1.40	25	COG	10nF	±5%	CL31C103JAFNNW#
3	1.00	50	COG	1nF	±5%	CL31C102JBCNNW#
4	1.00	50	COG	1.5nF	±2%	CL31C152GBCNNW#
5	1.40	50	COG	3.3nF	±5%	CL31C332JBFNNW#
6	1.80	50	COG	27nF	±5%	CL31C273JBHNNW#
7	1.80	50	COG	33nF	±5%	CL31C333JBHNNW#
8	1.00	100	COG	680pF	±5%	CL31C681JCCNNW#
9	1.00	100	COG	1nF	±5%	CL31C102JCCNNW#
10	1.00	100	COG	1nF	±10%	CL31C102KCCNNW#
11	1.40	500	COG	10pF	±5%	CL31C100JGFNNW#
12	1.40	500	COG	39pF	±5%	CL31C390JGFNNW#
13	1.40	500	COG	47pF	±5%	CL31C470JGFNNW#
14	1.40	500	COG	100pF	±2%	CL31C101GGFNNW#
15	1.40	630	COG	10pF	±5%	CL31C100JHFNNW#
16	1.40	630	COG	22pF	±5%	CL31C220JHFNNW#
17	1.40	630	COG	100pF	±5%	CL31C101JHFNNW#
18	1.40	630	COG	150pF	±5%	CL31C151JHFNNW#
19	1.40	630	COG	220pF	±5%	CL31C221JHFNNW#
20	1.80	630	COG	10nF	±5%	CL31C103JHHNNW#
21	2.70	100	COG	47nF	±5%	CL32C473JCJNNW#
22	2.70	630	COG	22nF	±5%	CL32C223JHJNNW#
23	2.70	630	COG	33nF	±5%	CL32C333JHJNNW#
24	2.80	1000	COG	22nF	±5%	CL32C223JIVNNW#

## Product Lineup (X5R)

Size Code (inch/mm) : 0201/0603

No.	Thickness Max. (mm)	Rated Voltage (Vdc)	TCC	Capacitance	Capacitance Tolerance	Part Number
1	0.33	6.3	X5R	10nF	±10%	CL03A103KQ3NNW#
2	0.33	6.3	X5R	100nF	±10%	CL03A104KQ3N3W#
3	0.33	6.3	X5R	100nF	±10%	CL03A104KQ3NNW#
4	0.33	6.3	X5R	470nF	±20%	CL03A474MQ3NNW#
5	0.39	6.3	X5R	2.2uF	±20%	CL03A225MQ3CRW#
6	0.33	10	X5R	2.2nF	±10%	CL03A222KP3NNW#
7	0.33	10	X5R	4.7nF	±10%	CL03A472KP3NNW#
8	0.33	10	X5R	10nF	±10%	CL03A103KP3NNW#
9	0.33	10	X5R	100nF	±10%	CL03A104KP3NNW#
10	0.33	10	X5R	100nF	±20%	CL03A104MP3NNW#
11	0.33	25	X5R	100nF	±10%	CL03A104KA3NNW#

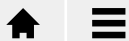

# Normal Capacitors\_High Level I

Size Code (inch/mm) : 0402/1005

No.	Thickness Max. (mm)	Rated Voltage (Vdc)	TCC	Capacitance	Capacitance Tolerance	Part Number
1	0.55	4	X5R	2.2uF	±20%	CL05A225MR5NNW#
2	0.65	4	X5R	4.7uF	±20%	CL05A475MR5NRW#
3	0.55	6.3	X5R	100nF	±10%	CL05A104KQ5NNW#
4	0.55	6.3	X5R	220nF	±10%	CL05A224KQ5NNW#
5	0.55	6.3	X5R	470nF	±10%	CL05A474KQ5NNW#
6	0.55	6.3	X5R	1uF	±10%	CL05A105KQ5NNW#
7	0.55	6.3	X5R	1uF	±20%	CL05A105MQ5NNW#
8	0.55	6.3	X5R	2.2uF	±20%	CL05A225MQ5NNW#
9	0.65	6.3	X5R	4.7uF	±20%	CL05A475MQ5NRW#
10	0.70	6.3	X5R	10uF	±20%	CL05A106MQ5NUW#
11	0.55	10	X5R	100nF	±10%	CL05A104KP5NNW#
12	0.55	10	X5R	220nF	±10%	CL05A224KP5NNW#
13	0.55	10	X5R	1uF	±10%	CL05A105KP5NNW#
14	0.60	10	X5R	1uF	±10%	CL05A105KP5NQW#
15	0.70	10	X5R	10uF	±20%	CL05A106MP5IUW#
16	0.55	16	X5R	100nF	±10%	CL05A104K05NNW#
17	0.55	16	X5R	220nF	±10%	CL05A224K05NNW#
18	0.55	16	X5R	470nF	±10%	CL05A474K05NNW#
19	0.55	16	X5R	1uF	±10%	CL05A105K05NNW#
20	0.60	16	X5R	1uF	±10%	CL05A105K05NQW#
21	0.55	16	X5R	1uF	±10%	CL05A105K05QNW#
22	0.60	16	X5R	1uF	±20%	CL05A105M05NQW#
23	0.55	25	X5R	100nF	±10%	CL05A104KA5NNW#
24	0.55	25	X5R	220nF	±10%	CL05A224KA5NNW#
25	0.55	25	X5R	470nF	±10%	CL05A474KA5NNW#
26	0.60	25	X5R	1uF	±10%	CL05A105KA5NQW#
27	0.65	35	X5R	1uF	±10%	CL05A105KL5NRW#

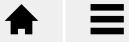

# Normal Capacitors\_High Level I

Size Code (inch/mm) : 0603/1608

No.	Thickness Max. (mm)	Rated Voltage (Vdc)	TCC	Capacitance	Capacitance Tolerance	Part Number
1	0.95	4Vdc	X5R	22uF	±20%	CL10A226MR8NQW#
2	1.05	4Vdc	X5R	22uF	±20%	CL10A226MR8NUW#
3	1.00	4Vdc	X5R	22uF	±20%	CL10A226MR8QRW#
4	1.00	4Vdc	X5R	47uF	±20%	CL10A476MR8NRW#
5	0.90	6.3Vdc	X5R	1uF	±10%	CL10A105KQ8NNW#
6	0.90	6.3Vdc	X5R	2.2uF	±10%	CL10A225KQ8NNW#
7	0.90	6.3Vdc	X5R	4.7uF	±10%	CL10A475KQ8NNW#
8	0.90	6.3Vdc	X5R	4.7uF	±20%	CL10A475MQ8NNW#
9	0.95	6.3Vdc	X5R	4.7uF	±20%	CL10A475MQ8NQW#
10	0.90	6.3Vdc	X5R	10uF	±10%	CL10A106KQ8NNW#
11	0.90	6.3Vdc	X5R	10uF	±20%	CL10A106MQ8NNW#
12	0.90	10Vdc	X5R	470nF	±10%	CL10A474KP8NNW#
13	0.90	10Vdc	X5R	1uF	±10%	CL10A105KP8NNW#
14	0.90	10Vdc	X5R	2.2uF	±10%	CL10A225KP8NNW#
15	0.90	10Vdc	X5R	4.7uF	±10%	CL10A475KP8NNW#
16	0.95	10Vdc	X5R	10uF	±10%	CL10A106KP8NQW#
17	0.95	10Vdc	X5R	10uF	±20%	CL10A106MP8NQW#
18	0.90	16Vdc	X5R	1uF	±10%	CL10A105K08NNW#
19	0.90	16Vdc	X5R	2.2uF	±10%	CL10A225K08NNW#
20	0.95	16Vdc	X5R	4.7uF	±10%	CL10A475K08NQW#
21	0.90	25Vdc	X5R	220nF	±10%	CL10A224KA8NNW#
22	0.90	25Vdc	X5R	470nF	±10%	CL10A474KA8NNW#
23	0.90	25Vdc	X5R	1uF	±10%	CL10A105KA8NNW#
24	0.90	25Vdc	X5R	2.2uF	±10%	CL10A225KA8NNW#
25	0.90	35Vdc	X5R	1uF	±10%	CL10A105KL8NNW#
26	0.90	50Vdc	X5R	220nF	±10%	CL10A224KB8NNW#
27	0.90	50Vdc	X5R	1uF	±10%	CL10A105KB8NNW#

Size Code (inch/mm) : 0805/2012

No.	Thickness Max. (mm)	Rated Voltage (Vdc)	TCC	Capacitance	Capacitance Tolerance	Part Number
1	1.45	2.5	X5R	100uF	±20%	CL21A107MSYNNW#
2	1.45	4	X5R	47uF	±20%	CL21A476MRYNNW#
3	1.45	4	X5R	100uF	±20%	CL21A107MRYNNW#
4	1.35	6.3	X5R	4.7uF	±10%	CL21A475KQFNNW#
5	1.35	6.3	X5R	4.7uF	±20%	CL21A475MQFNNW#
6	1.35	6.3	X5R	10uF	±10%	CL21A106KQFNNW#
7	1.40	6.3	X5R	22uF	±20%	CL21A226MQQNNW#
8	1.45	6.3	X5R	22uF	±20%	CL21A226MQYNNW#
9	1.45	6.3	X5R	47uF	±20%	CL21A476MQYNNW#
10	1.45	6.3	X5R	100uF	±20%	CL21A107MQYNNW#
11	1.35	10	X5R	2.2uF	±10%	CL21A225KPFNNW#
12	1.35	10	X5R	4.7uF	±10%	CL21A475KPFNNW#
13	1.35	10	X5R	10uF	±10%	CL21A106KPFNNW#
14	1.35	10	X5R	10uF	±20%	CL21A106MPFNNW#
15	1.40	10	X5R	10uF	±20%	CL21A106MPQNNW#
16	1.45	10	X5R	22uF	±20%	CL21A226MPYNNW#
17	1.45	10	X5R	47uF	±20%	CL21A476MPYNNW#



# Normal Capacitors\_High Level I

Size Code (inch/mm) : 0805/2012

No.	Thickness Max. (mm)	Rated Voltage (Vdc)	TCC	Capacitance	Capacitance Tolerance	Part Number
18	1.35	16	X5R	10uF	±10%	CL21A106KOFNNW#
19	1.40	16	X5R	10uF	±10%	CL21A106KQOQNNW#
20	1.45	16	X5R	22uF	±20%	CL21A226MOYNNW#
21	1.35	25	X5R	2.2uF	±10%	CL21A225KAFNNW#
22	1.35	25	X5R	4.7uF	±10%	CL21A475KAFNNW#
23	1.40	25	X5R	4.7uF	±10%	CL21A475KAQNNW#
24	1.45	25	X5R	10uF	±10%	CL21A106KAYQNNW#
25	1.45	25	X5R	10uF	±20%	CL21A106MAYQNNW#
26	1.45	25	X5R	22uF	±20%	CL21A226MAYNNW#

Size Code (inch/mm) : 1206/3216

No.	Thickness Max. (mm)	Rated Voltage (Vdc)	TCC	Capacitance	Capacitance Tolerance	Part Number
1	1.90	4	X5R	100uF	±20%	CL31A107MRKNNW#
2	1.80	6.3	X5R	10uF	±10%	CL31A106KQHNNW#
3	1.80	6.3	X5R	22uF	±10%	CL31A226KQHNNW#
4	1.80	6.3	X5R	22uF	±20%	CL31A226MQHNNW#
5	1.80	6.3	X5R	47uF	±10%	CL31A476KQHNNW#
6	1.80	6.3	X5R	47uF	±20%	CL31A476MQHNNW#
7	1.90	6.3	X5R	100uF	±20%	CL31A107MQKNNW#
8	1.80	10	X5R	22uF	±10%	CL31A226KPHNNW#
9	1.80	10	X5R	22uF	±20%	CL31A226MPHNNW#
10	1.80	10	X5R	47uF	±10%	CL31A476KPHNNW#
11	1.90	10	X5R	100uF	±20%	CL31A107MPKNNW#
12	1.80	16	X5R	22uF	±10%	CL31A226KOHNNW#
13	1.80	16	X5R	22uF	±20%	CL31A226MOHNNW#
14	1.80	25	X5R	4.7uF	±10%	CL31A475KAHNNW#
15	1.80	25	X5R	10uF	±10%	CL31A106KAHNNW#
16	1.80	25	X5R	10uF	±20%	CL31A106MAHNNW#
17	1.80	25	X5R	22uF	±10%	CL31A226KAHNNW#
18	1.80	25	X5R	22uF	±20%	CL31A226MAHNNW#
19	1.80	50	X5R	4.7uF	±10%	CL31A475KBHNNW#
20	1.80	50	X5R	10uF	±10%	CL31A106KBHNNW#

Size Code (inch/mm) : 1210/3225

No.	Thickness Max. (mm)	Rated Voltage (Vdc)	TCC	Capacitance	Capacitance Tolerance	Part Number
1	2.70	6.3	X5R	22uF	±10%	CL32A226KQJNNW#
2	2.70	6.3	X5R	22uF	±20%	CL32A226MQJNNW#
3	2.80	6.3	X5R	100uF	±20%	CL32A107MQVNNW#
4	2.80	6.3	X5R	200uF	±20%	CL32A227MQVNNW#
5	2.70	10	X5R	22uF	±10%	CL32A226KPJNNW#
6	2.70	10	X5R	22uF	±20%	CL32A226MPJNNW#
7	2.70	10	X5R	47uF	±10%	CL32A476KPJNNW#
8	2.80	10	X5R	100uF	±20%	CL32A107MPVNNW#
9	2.70	16	X5R	22uF	±10%	CL32A226KOJNNW#
10	2.70	16	X5R	47uF	±10%	CL32A476KOJNNW#
11	2.70	16	X5R	47uF	±20%	CL32A476MOJNNW#
12	2.70	25	X5R	22uF	±10%	CL32A226KAJNNW#
13	2.70	25	X5R	22uF	±20%	CL32A226MAJNNW#
14	2.70	50	X5R	10uF	±10%	CL32A106KBJNNW#



# Normal Capacitors\_High Level I

## Product Lineup (X6S)

Size Code (inch/mm) : 0201/0603

No.	Thickness Max. (mm)	Rated Voltage (Vdc)	TCC	Capacitance	Capacitance Tolerance	Part Number
1	0.33	4	X6S	100nF	±20%	CL03X104MR3NNW#
2	0.33	6.3	X6S	100nF	±10%	CL03X104KQ3NNW#
3	0.33	6.3	X6S	100nF	±20%	CL03X104MQ3NNW#
4	0.39	6.3	X6S	1µF	±20%	CL03X105MQ3CRW#
5	0.33	10	X6S	100nF	±10%	CL03X104KP3NNW#
6	0.39	10	X6S	220nF	±10%	CL03X224KP3NRW#
7	0.39	10	X6S	330nF	±10%	CL03X334KP3NRW#
8	0.33	16	X6S	100nF	±10%	CL03X104K03NNW#
9	0.33	25	X6S	100nF	±10%	CL03X104KA3NNW#

Size Code (inch/mm) : 0402/1005

No.	Thickness Max. (mm)	Rated Voltage (Vdc)	TCC	Capacitance	Capacitance Tolerance	Part Number
1	0.50	2.5	X6S	4.3µF	±20%	CL05X435MS5NWW#
2	0.80	2.5	X6S	22µF	±20%	CL05X226MS6NUW#
3	0.55	4	X6S	470nF	±20%	CL05X474MR5NNW#
4	0.55	4	X6S	1µF	±20%	CL05X105MR5NNW#
5	0.70	4	X6S	2.2µF	±20%	CL05X225MR5QUW#
6	0.70	4	X6S	10µF	±20%	CL05X106MR5NUW#
7	0.80	4	X6S	22µF	±20%	CL05X226MR6NUW#
8	0.55	6.3	X6S	470nF	±10%	CL05X474KQ5NNW#
9	0.55	6.3	X6S	1µF	±10%	CL05X105KQ5NNW#
10	0.60	6.3	X6S	1µF	±10%	CL05X105KQ5NQW#
11	0.55	6.3	X6S	1µF	±20%	CL05X105MQ5NNW#
12	0.70	6.3	X6S	2.2µF	±20%	CL05X225MQ5QUW#
13	0.70	6.3	X6S	4.7µF	±20%	CL05X475MQ5NUW#
14	0.70	6.3	X6S	10µF	±20%	CL05X106MQ5NUW#
15	0.55	10	X6S	1µF	±10%	CL05X105KP5NNW#
16	0.55	10	X6S	1µF	±20%	CL05X105MP5NNW#
17	0.70	10	X6S	2.2µF	±10%	CL05X225KP5QUW#
18	0.70	10	X6S	2.2µF	±20%	CL05X225MP5QUW#
19	0.60	16	X6S	1µF	±10%	CL05X105K05NQW#
20	0.70	16	X6S	2.2µF	±20%	CL05X225M05NUW#
21	0.60	25	X6S	1µF	±10%	CL05X105KA5NQW#
22	0.60	25	X6S	1µF	±20%	CL05X105MA5NQW#

Size Code (inch/mm) : 0603/1608

No.	Thickness Max. (mm)	Rated Voltage (Vdc)	TCC	Capacitance	Capacitance Tolerance	Part Number
1	1.00	2.5	X6S	47µF	±20%	CL10X476MS8NRW#
2	0.90	4	X6S	4.7µF	±10%	CL10X475KR8NNW#
3	0.90	4	X6S	10µF	±20%	CL10X106MR8NNW#
4	1.00	4	X6S	22µF	±20%	CL10X226MR8NUW#

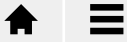

# Normal Capacitors\_High Level I

Size Code (inch/mm) : 0603/1608

No.	Thickness Max. (mm)	Rated Voltage (Vdc)	TCC	Capacitance	Capacitance Tolerance	Part Number
5	1.05	4	X6S	22uF	±20%	CL10X226MR8QRW#
6	1.00	4	X6S	47uF	±20%	CL10X476MR8NRW#
7	1.00	6.3	X6S	4.7uF	±10%	CL10X475KQ8NRW#
8	0.90	6.3	X6S	4.7uF	±20%	CL10X475MQ8NNW#
9	0.95	6.3	X6S	4.7uF	±20%	CL10X475MQ8NQW#
10	1.00	6.3	X6S	4.7uF	±20%	CL10X475MQ8NRW#
11	1.00	6.3	X6S	22uF	±20%	CL10X226MQ8QRW#
12	1.00	10	X6S	10uF	±20%	CL10X106MP8NRW#
13	1.00	16	X6S	4.7uF	±10%	CL10X475K08NRW#
14	1.00	16	X6S	10uF	±20%	CL10X106M08NRW#

Size Code (inch/mm) : 0805/2012

No.	Thickness Max. (mm)	Rated Voltage (Vdc)	TCC	Capacitance	Capacitance Tolerance	Part Number
1	1.45	2.5	X6T	47uF	±20%	CL21W476MSYNNW#
2	1.40	4	X6S	22uF	±20%	CL21X226MRQNNW#
3	1.45	4	X6S	22uF	±20%	CL21X226MRYNNW#
4	1.45	4	X6T	47uF	±20%	CL21W476MRYNNW#
5	1.45	4	X6S	47uF	±20%	CL21X476MRYNNW#
6	1.45	4	X6S	100uF	±20%	CL21X107MRYNNW#
7	1.40	6.3	X6S	10uF	±10%	CL21X106KQQNNW#
8	1.40	6.3	X6S	10uF	±20%	CL21X106MQQNNW#
9	1.40	6.3	X6S	22uF	±20%	CL21X226MQQNNW#
10	1.45	6.3	X6S	22uF	±20%	CL21X226MQYNNW#
11	1.45	6.3	X6S	47uF	±20%	CL21X476MQYNNW#
12	1.40	10	X6S	10uF	±10%	CL21X106KPYNNW#
13	1.40	10	X6S	10uF	±20%	CL21X106MPQNNW#
14	1.45	10	X6S	22uF	±20%	CL21X226MPYNNW#
15	1.40	16	X6S	10uF	±10%	CL21X106KQNNW#
16	1.40	16	X6S	10uF	±20%	CL21X106MQNNW#
17	1.45	16	X6S	22uF	±20%	CL21X226MOYNNW#
18	1.45	25	X6S	10uF	±10%	CL21X106KAYQNNW#
19	1.45	25	X6S	10uF	±20%	CL21X106MAYQNNW#

Size Code (inch/mm) : 1206/3216, 1210/3225

No.	Thickness Max. (mm)	Rated Voltage (Vdc)	TCC	Capacitance	Capacitance Tolerance	Part Number
1	1.90	4	X6S	100uF	±20%	CL31X107MRKNNW#
2	1.80	6.3	X6S	47uF	±20%	CL31X476MQHNNW#
3	1.90	6.3	X6S	100uF	±20%	CL31X107MQKNNW#
4	2.80	4	X6S	100uF	±20%	CL32X107MRVNNW#
5	2.80	6.3	X6S	100uF	±20%	CL32X107MQVNNW#
6	2.70	16	X6S	47uF	±20%	CL32X476MOJNNW#



# Normal Capacitors\_High Level I

## Product Lineup (X7R)

Size Code (inch/mm) : 0201/0603

No.	Thickness Max. (mm)	Rated Voltage (Vdc)	TCC	Capacitance	Capacitance Tolerance	Part Number
1	0.33	6.3	X7R	10nF	±10%	CL03B103KQ3NNW#
2	0.33	10	X7R	10nF	±10%	CL03B103KP3NNW#
3	0.33	10	X7R	100nF	±10%	CL03B104KP3NNW#
4	0.33	10	X7S	100nF	±10%	CL03Y104KP3NNW#
5	0.33	16	X7R	1nF	±10%	CL03B102K03NNW#
6	0.33	16	X7R	10nF	±10%	CL03B103K03NNW#
7	0.33	25	X7R	680pF	±10%	CL03B681KA3NNW#
8	0.33	25	X7R	1nF	±10%	CL03B102KA3NNW#
9	0.33	25	X7R	10nF	±10%	CL03B103KA3NNW#

Size Code (inch/mm) : 0402/1005

No.	Thickness Max. (mm)	Rated Voltage (Vdc)	TCC	Capacitance	Capacitance Tolerance	Part Number
1	0.55	4	X7R	1uF	±10%	CL05B105KR5QNW#
2	0.55	6.3	X7R	100nF	±10%	CL05B104KQ5NNW#
3	0.55	6.3	X7R	220nF	±10%	CL05B224KQ5NNW#
4	0.55	6.3	X7R	470nF	±10%	CL05B474KQ5ZNNW#
5	0.55	6.3	X7R	1uF	±10%	CL05B105KQ5QNW#
6	0.55	10	X7R	10nF	±10%	CL05B103KP5NNW#
7	0.55	10	X7R	27nF	±10%	CL05B273KP5NNW#
8	0.55	10	X7R	33nF	±10%	CL05B333KP5NNW#
9	0.55	10	X7R	47nF	±10%	CL05B473KP5NNW#
10	0.55	10	X7R	100nF	±10%	CL05B104KP5NNW#
11	0.55	10	X7R	220nF	±10%	CL05B224KP5NNW#
12	0.55	10	X7R	470nF	±10%	CL05B474KP5ZNNW#
13	0.55	16	X7R	1nF	±10%	CL05B102K05NNW#
14	0.55	16	X7R	10nF	±5%	CL05B103J05NNW#
15	0.55	16	X7R	10nF	±10%	CL05B103K05NNW#
16	0.55	16	X7R	10nF	±20%	CL05B103M05NNW#
17	0.55	16	X7R	15nF	±10%	CL05B153K05NNW#
18	0.55	16	X7R	22nF	±10%	CL05B223K05NNW#
19	0.55	16	X7R	33nF	±10%	CL05B333K05NNW#
20	0.55	16	X7R	39nF	±10%	CL05B393K05NNW#
21	0.55	16	X7R	47nF	±10%	CL05B473K05NNW#
22	0.55	16	X7R	68nF	±10%	CL05B683K05NNW#
23	0.55	16	X7R	82nF	±10%	CL05B823K05NNW#
24	0.55	16	X7R	100nF	±10%	CL05B104K05NNW#
25	0.55	16	X7R	220nF	±10%	CL05B224K05NNW#
26	0.70	16	X7T	2.2uF	±20%	CL05Z225M05NUW#
27	0.55	25	X7R	220pF	±10%	CL05B221KA5NNW#
28	0.55	25	X7R	1nF	±10%	CL05B102KA5NNW#
29	0.55	25	X7R	3.3nF	±10%	CL05B332KA5NNW#
30	0.55	25	X7R	3.9nF	±10%	CL05B392KA5NNW#

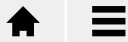

# Normal Capacitors\_High Level I

Size Code (inch/mm) : 0402/1005

No.	Thickness Max. (mm)	Rated Voltage (Vdc)	TCC	Capacitance	Capacitance Tolerance	Part Number
31	0.55	25	X7R	4.7nF	±10%	CL05B472KA5NNW#
32	0.55	25	X7R	5.6nF	±10%	CL05B562KA5NNW#
33	0.55	25	X7R	6.8nF	±10%	CL05B682KA5NNW#
34	0.55	25	X7R	8.2nF	±10%	CL05B822KA5NNW#
35	0.55	25	X7R	10nF	±5%	CL05B103JA5NNW#
36	0.55	25	X7R	10nF	±10%	CL05B103KA5NNW#
37	0.55	25	X7R	15nF	±10%	CL05B153KA5NNW#
38	0.55	25	X7R	22nF	±10%	CL05B223KA5NNW#
39	0.55	25	X7R	33nF	±10%	CL05B333KA5NNW#
40	0.55	25	X7R	47nF	±10%	CL05B473KA5NNW#
41	0.55	25	X7R	100nF	±10%	CL05B104KA5NNW#
42	0.55	25	X7R	100nF	±20%	CL05B104MA5NNW#
43	0.55	25	X7R	220nF	±10%	CL05B224KA5NNW#
44	0.55	50	X7R	220pF	±10%	CL05B221KB5NNW#
45	0.55	50	X7R	270pF	±10%	CL05B271KB5NNW#
46	0.55	50	X7R	330pF	±10%	CL05B331KB5NNW#
47	0.55	50	X7R	390pF	±10%	CL05B391KB5NNW#
48	0.55	50	X7R	470pF	±10%	CL05B471KB5NNW#
49	0.55	50	X7R	560pF	±10%	CL05B561KB5NNW#
50	0.55	50	X7R	680pF	±10%	CL05B681KB5NNW#
51	0.55	50	X7R	820pF	±10%	CL05B821KB5NNW#
52	0.55	50	X7R	1nF	±5%	CL05B102JB5NNW#
53	0.55	50	X7R	1nF	±10%	CL05B102KB5NNW#
54	0.55	50	X7R	1.5nF	±10%	CL05B152KB5NNW#
55	0.55	50	X7R	1.8nF	±10%	CL05B182KB5NNW#
56	0.55	50	X7R	2.2nF	±10%	CL05B222KB5NNW#
57	0.55	50	X7R	2.7nF	±10%	CL05B272KB5NNW#
58	0.55	50	X7R	3.3nF	±5%	CL05B332JB5NNW#
59	0.55	50	X7R	3.3nF	±10%	CL05B332KB5NNW#
60	0.55	50	X7R	3.9nF	±10%	CL05B392KB5NNW#
61	0.55	50	X7R	4.7nF	±10%	CL05B472KB5NNW#
62	0.55	50	X7R	8.2nF	±10%	CL05B822KB5NNW#
63	0.55	50	X7R	10nF	±10%	CL05B103KB5NNW#
64	0.55	50	X7R	22nF	±10%	CL05B223KB5NNW#
65	0.55	50	X7R	100nF	±10%	CL05B104KB5NNW#



# Normal Capacitors\_High Level I

Size Code (inch/mm) : 0603/1608

No.	Thickness Max. (mm)	Rated Voltage (Vdc)	TCC	Capacitance	Capacitance Tolerance	Part Number
1	0.90	6.3	X7R	2.2uF	±10%	CL10B225KQ8N3W#
2	0.95	6.3	X7T	4.7uF	±10%	CL10Z475KQ8NQW#
3	0.90	10	X7R	220nF	±10%	CL10B224KP8NNW#
4	0.90	10	X7R	1uF	±10%	CL10B105KP8NNW#
5	0.90	10	X7R	2.2uF	±10%	CL10B225KP8N3W#
6	0.90	16	X7R	47nF	±10%	CL10B473K08NNW#
7	0.90	16	X7R	100nF	±10%	CL10B104K08NNW#
8	0.90	16	X7R	150nF	±10%	CL10B154K08NNW#
9	0.90	16	X7R	220nF	±5%	CL10B224J08NNW#
10	0.90	16	X7R	220nF	±10%	CL10B224K08NNW#
11	0.90	16	X7R	470nF	±10%	CL10B474K08NNW#
12	0.90	16	X7R	680nF	±10%	CL10B684K08NNW#
13	0.90	16	X7R	1uF	±10%	CL10B105K08NNW#
14	0.90	25	X7R	10nF	±10%	CL10B103KA8NNW#
15	0.90	25	X7R	22nF	±10%	CL10B223KA8NNW#
16	0.90	25	X7R	33nF	±10%	CL10B333KA8NNW#
17	0.90	25	X7R	39nF	±10%	CL10B393KA8NNW#
18	0.90	25	X7R	47nF	±10%	CL10B473KA8NNW#
19	0.90	25	X7R	100nF	±10%	CL10B104KA8NNW#
20	0.90	25	X7R	100nF	±20%	CL10B104MA8NNW#
21	0.90	25	X7R	1uF	±10%	CL10B105KA8NNW#
22	0.90	50	X7R	100pF	±10%	CL10B101KB8NNW#
23	0.90	50	X7R	220pF	±10%	CL10B221KB8NNW#
24	0.90	50	X7R	330pF	±10%	CL10B331KB8NNW#
25	0.90	50	X7R	470pF	±10%	CL10B471KB8NNW#
26	0.90	50	X7R	680pF	±10%	CL10B681KB8NNW#
27	0.90	50	X7R	1nF	±10%	CL10B102KB8NNW#
28	0.90	50	X7R	1.5nF	±10%	CL10B152KB8NNW#
29	0.90	50	X7R	2.2nF	±5%	CL10B222JB8NNW#
30	0.90	50	X7R	2.2nF	±10%	CL10B222KB8NNW#
31	0.90	50	X7R	3.3nF	±10%	CL10B332KB8NNW#
32	0.90	50	X7R	3.9nF	±10%	CL10B392KB8NNW#
33	0.90	50	X7R	4.7nF	±10%	CL10B472KB8NNW#
34	0.90	50	X7R	6.8nF	±10%	CL10B682KB8NNW#
35	0.90	50	X7R	8.2nF	±10%	CL10B822KB8NNW#
36	0.90	50	X7R	10nF	±5%	CL10B103JB8NNW#
37	0.90	50	X7R	10nF	±10%	CL10B103KB8NNW#
38	0.90	50	X7R	22nF	±10%	CL10B223KB8NNW#
39	0.90	50	X7R	27nF	±10%	CL10B273KB8NNW#
40	0.90	50	X7R	33nF	±10%	CL10B333KB8NNW#
41	0.90	50	X7R	47nF	±10%	CL10B473KB8NNW#
42	0.90	50	X7R	100nF	±5%	CL10B104JB8NNW#
43	0.90	50	X7R	100nF	±10%	CL10B104KB8NNW#
44	0.90	50	X7R	220nF	±10%	CL10B224KB8NNW#
45	0.90	100	X7R	1nF	±10%	CL10B102KC8NNW#
46	0.90	100	X7R	10nF	±10%	CL10B103KC8NNW#
47	0.90	100	X7R	100nF	±10%	CL10B104KC8N3W#



# Normal Capacitors\_High Level I

Size Code (inch/mm) : 0805/2012

No.	Thickness Max. (mm)	Rated Voltage (Vdc)	TCC	Capacitance	Capacitance Tolerance	Part Number
1	1.40	6.3	X7R	10uF	±10%	CL21B106KQNNW#
2	1.45	6.3	X7T	22uF	±20%	CL21Z226MQYNNW#
3	1.35	10	X7R	2.2uF	±10%	CL21B225KPFNNW#
4	1.40	10	X7R	10uF	±10%	CL21B106KQNNW#
5	1.35	16	X7R	2.2uF	±10%	CL21B225KOFNNW#
6	1.35	16	X7R	4.7uF	±10%	CL21B475KOFNNW#
7	0.95	25	X7R	100nF	±10%	CL21B104KACNNW#
8	1.35	25	X7R	1uF	±10%	CL21B105KAFNNW#
9	1.35	25	X7R	2.2uF	±10%	CL21B225KAFNNW#
10	0.75	50	X7R	220pF	±10%	CL21B221KBANNW#
11	0.75	50	X7R	330pF	±10%	CL21B331KBANNW#
12	0.75	50	X7R	470pF	±10%	CL21B471KBANNW#
13	0.75	50	X7R	680pF	±10%	CL21B681KBANNW#
14	0.75	50	X7R	820pF	±10%	CL21B821KBANNW#
15	0.75	50	X7R	1nF	±10%	CL21B102KBANNW#
16	0.75	50	X7R	1.8nF	±10%	CL21B182KBANNW#
17	0.75	50	X7R	2.7nF	±10%	CL21B272KBANNW#
18	0.75	50	X7R	3.3nF	±10%	CL21B332KBANNW#
19	0.75	50	X7R	4.7nF	±10%	CL21B472KBANNW#
20	0.75	50	X7R	5.6nF	±10%	CL21B562KBANNW#
21	0.75	50	X7R	6.8nF	±10%	CL21B682KBANNW#
22	0.75	50	X7R	8.2nF	±10%	CL21B822KBANNW#
23	0.75	50	X7R	10nF	±10%	CL21B103KBANNW#
24	0.75	50	X7R	15nF	±10%	CL21B153KBANNW#
25	0.75	50	X7R	18nF	±10%	CL21B183KBANNW#
26	0.75	50	X7R	22nF	±10%	CL21B223KBANNW#
27	0.75	50	X7R	27nF	±10%	CL21B273KBANNW#
28	0.75	50	X7R	39nF	±10%	CL21B393KBANNW#
29	0.95	50	X7R	47nF	±10%	CL21B473KBCNNW#
30	0.95	50	X7R	56nF	±10%	CL21B563KBCNNW#
31	0.95	50	X7R	68nF	±10%	CL21B683KBCNNW#
32	0.95	50	X7R	82nF	±10%	CL21B823KBCNNW#
33	0.95	50	X7R	100nF	±10%	CL21B104KBCNNW#
34	1.35	50	X7R	1uF	±10%	CL21B105KBFNNW#
35	1.45	50	X7R	2.2uF	±10%	CL21B225KBYNNW#
36	0.75	100	X7R	10nF	±10%	CL21B103KCANNW#
37	1.45	100	X7S	1uF	±10%	CL21Y105KCYZNW#



# Normal Capacitors\_High Level I

Size Code (inch/mm) : 1206/3216

No.	Thickness Max. (mm)	Rated Voltage (Vdc)	TCC	Capacitance	Capacitance Tolerance	Part Number
1	1.80	4	X7S	47uF	±20%	CL31Y476MRHNNW#
2	1.80	6.3	X7R	22uF	±10%	CL31B226KQHNNW#
3	1.80	10	X7R	22uF	±10%	CL31B226KPHNNW#
4	1.90	10	X7R	22uF	±10%	CL31B226KPKZNNW#
5	1.40	16	X7R	220nF	±10%	CL31B224KOFNNW#
6	1.80	16	X7R	470nF	±10%	CL31B474KOHNNW#
7	1.80	16	X7R	680nF	±10%	CL31B684KOHNNW#
8	1.40	16	X7R	1uF	±10%	CL31B105KOFNNW#
9	1.80	16	X7R	2.2uF	±10%	CL31B225KOHNNW#
10	1.80	16	X7R	10uF	±10%	CL31B106KOHN3W#
11	1.40	25	X7R	220nF	±10%	CL31B224KAFNNW#
12	1.80	25	X7R	470nF	±10%	CL31B474KAHNNW#
13	1.80	25	X7R	680nF	±10%	CL31B684KAHNNW#
14	1.80	25	X7R	1uF	±10%	CL31B105KAHNNW#
15	1.80	25	X7R	1uF	±20%	CL31B105MAHNNW#
16	1.80	25	X7R	2.2uF	±10%	CL31B225KAHNNW#
17	1.80	25	X7R	4.7uF	±10%	CL31B475KAHNNW#
18	1.80	25	X7R	10uF	±10%	CL31B106KAHN3W#
19	1.00	50	X7R	100nF	±10%	CL31B104KBCNNW#
20	1.40	50	X7R	330nF	±10%	CL31B334KBFNNW#
21	1.80	50	X7R	470nF	±10%	CL31B474KBHNNW#
22	1.80	50	X7R	1uF	±10%	CL31B105KBHNNW#
23	1.80	50	X7R	2.2uF	±10%	CL31B225KBHNNW#
24	1.80	50	X7R	4.7uF	±10%	CL31B475KBHNNW#
25	1.40	100	X7R	10nF	±10%	CL31B103KCFNNW#
26	1.80	100	X7R	2.2uF	±10%	CL31B225KCHZNNW#
27	1.40	500	X7R	470pF	±10%	CL31B471KGFNNW#
28	1.40	500	X7R	680pF	±10%	CL31B681KGFNNW#
29	1.40	500	X7R	2.2nF	±10%	CL31B222KGFNNW#
30	1.40	630	X7R	470pF	±10%	CL31B471KHFNNW#
31	1.40	630	X7R	680pF	±10%	CL31B681KHFNNW#
32	1.40	630	X7R	1.5nF	±10%	CL31B152KHFNNW#
33	1.40	630	X7R	2.2nF	±10%	CL31B222KHFNNW#
34	1.40	630	X7R	3.3nF	±10%	CL31B332KHFNNW#
35	1.40	630	X7R	4.7nF	±10%	CL31B472KHFNNW#
36	1.40	630	X7R	6.8nF	±10%	CL31B682KHFNNW#
37	1.40	630	X7R	10nF	±10%	CL31B103KHFNNW#

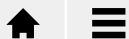

# Normal Capacitors\_High Level I

Size Code (inch/mm) : 1210/3225

No.	Thickness Max. (mm)	Rated Voltage (Vdc)	TCC	Capacitance	Capacitance Tolerance	Part Number
1	2.80	6.3	X7S	100uF	±20%	CL32Y107MQVNNW#
2	2.80	10	X7R	10uF	±10%	CL32B106KPVZNNW#
3	2.70	16	X7R	4.7uF	±10%	CL32B475KQJNNW#
4	2.80	16	X7R	10uF	±10%	CL32B106KOVZNNW#
5	2.00	25	X7R	10uF	±10%	CL32B106KAULNNW#
6	2.80	25	X7S	22uF	±10%	CL32Y226KAVZNNW#
7	2.70	50	X7R	4.7uF	±10%	CL32B475KBJNNW#
8	2.80	50	X7R	10uF	±10%	CL32B106KBVZNNW#
9	2.70	100	X7R	2.2uF	±10%	CL32B225KCJZNNW#
10	2.20	100	X7R	4.7uF	±10%	CL32B475KCIZNNW#
11	2.20	100	X7S	4.7uF	±10%	CL32Y475KCIZNNW#
12	2.80	100	X7S	10uF	±10%	CL32Y106KCVZNNW#
13	2.20	630	X7R	47nF	±10%	CL32B473KHINNW#
14	2.20	1000	X7R	22nF	±10%	CL32B223KIIZNNW#

# Normal Capacitors\_High Level II

Normal High Level II

## Features

- A High Level II MLCC is a chip-type capacitor designed to be suitable for outdoor industrial applications.
- Reliability for moisture resistance and temperature change has been strengthened, and the bending strength characteristic is excellent.

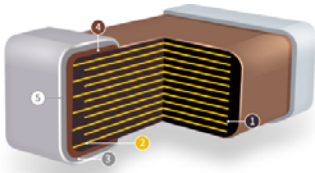

- ❶ Ceramic Body
- ❷ Electrode (Ni/Cu\*)
- ❸ Plating (Ni)
- ❹ Termination (Cu or Cu+Metal Epoxy)
- ❺ Plating (Sn)

High Level I

Improved Reliability  
 (65°C, 90%RH, 1Vr, 500H)

High Level II

Reinforced Reliability  
 (85°C, 85%RH, 1Vr, 1000H)

\* Internal Cu electrode is only applied to limited products.

## Application

- Base station, Solar Inverter, DC-DC Converter

## Structure and Dimensions

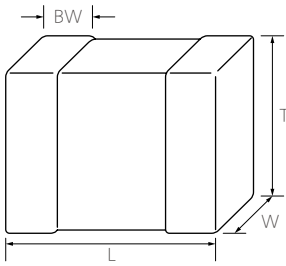

Size Code	Dimension (mm)				EIA (inch)
	L	W	T	BW	
03	0.60±0.03	0.30±0.03	0.30±0.03	0.15±0.05	0603
05	1.00±0.05	0.50±0.05	0.50±0.05	0.25±0.10	0402
10	1.60±0.10	0.80±0.10	0.80±0.10	0.30±0.20	0603
21	2.00±0.10	1.25±0.10	1.25±0.10	0.5±0.2/-0.3	0805
31	3.20±0.20	1.60±0.20	1.60±0.20	0.50±0.30	1206
	3.20±0.30	1.60±0.30	1.60±0.30		
32	3.20±0.30	2.50±0.20	2.00±0.20	0.60±0.30	1210
	3.20±0.30	2.50±0.30	2.50±0.30		

## Capacitance Table (COG)

Category	TCC	Size Code (inch/mm)	Rated Voltage (Vdc)	Capacitance									Capacitance Range				
				pF			nF			uF							
				0.1	1	10	100	1	10	100	1	10		100			
High Level II	COG (125°C)	0402/1005	50													3.3pF - 1nF	
			25														1nF - 6.8nF
		0603/1608	50														22pF - 3.3nF
			100														100pF - 4.7nF
		1206/3216	50														47nF - 100nF
			630														10nF - 10nF
			1000														680pF - 1nF
		1210/3225	630														22nF - 33nF
1000															10nF - 22nF		

## Capacitance Table (X5R)

Category	TCC	Size Code (inch/mm)	Rated Voltage (Vdc)	Capacitance									Capacitance Range					
				pF			nF			uF								
				0.1	1	10	100	1	10	100	1	10		100				
High Level II	X5R (85°C)	0603/1608	6.3													4.7uF - 4.7uF		
			10														1uF - 10uF	
			16															1uF - 1uF
			25															1uF - 1uF
		0805/2012	6.3														22uF - 22uF	

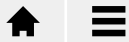

# Normal Capacitors\_High Level II

## Capacitance Table (X6S)

Category	TCC	Size Code (inch/mm)	Rated Voltage (Vdc)	Capacitance									Capacitance Range				
				pF			nF			uF							
				0.1	1	10	100	1	10	100	1	10		100			
High Level II	X6S (105°C)	0805/2012	4													47uF - 47uF	
			25														4.7uF - 4.7uF
		1206/3216	6.3														100uF - 100uF
		1210/3225	2.5														330uF - 330uF

## Capacitance Table (X7R)

Category	TCC	Size Code (inch/mm)	Rated Voltage (Vdc)	Capacitance									Capacitance Range				
				pF			nF			uF							
				0.1	1	10	100	1	10	100	1	10		100			
High Level II	X7R (125°C)	0201/0603	10													100nF - 100nF	
			25														100nF - 100nF
		0402/1005	50														4.7nF - 100nF
			10														1uF - 2.2uF
		0603/1608	16														1uF - 1uF
			25														8.2nF - 1uF
			50														270pF - 47nF
			100														100nF - 100nF
		0805/2012	16														10uF - 10uF
			25														10uF - 10uF
1206/3216	50														1uF - 1uF		
	10														47uF - 47uF		

## Capacitance Table (X7S)

Category	TCC	Size Code (inch/mm)	Rated Voltage (Vdc)	Capacitance									Capacitance Range				
				pF			nF			uF							
				0.1	1	10	100	1	10	100	1	10		100			
High Level II	X7S (125°C)	0201/0603	10													100nF - 100nF	
		0603/1608	10														4.7uF - 4.7uF
			16														4.7uF - 4.7uF
		0805/2012	25														4.7uF - 4.7uF
		1206/3216	4														47uF - 47uF
1210/3225	6.3														100uF - 100uF		

## Capacitance Table (X7T)

Category	TCC	Size Code (inch/mm)	Rated Voltage (Vdc)	Capacitance									Capacitance Range				
				pF			nF			uF							
				0.1	1	10	100	1	10	100	1	10		100			
High Level II	X7T (125°C)	0603/1608	6.3													10uF - 10uF	
			10														10uF - 10uF
		1206/3216	4														100uF - 100uF
			6.3														

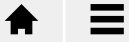

# Normal Capacitors\_High Level II

## Product Lineup (COG)

Size Code (inch/mm) : 0402/1005, 0603/1608

No.	Thickness Max. (mm)	Rated Voltage (Vdc)	TCC	Capacitance	Capacitance Tolerance	Part Number
1	0.55	50	COG	5.6pF	±0.25pF	CL05C5R6CB5N4N#
2	0.55	50	COG	47pF	±5%	CL05C470JB5N4N#
3	0.55	50	COG	100pF	±5%	CL05C101JB5N4N#
4	0.55	50	COG	330pF	±5%	CL05C331JB5N4N#
5	0.55	50	COG	1nF	±5%	CL05C102JB5N4N#
6	0.90	25	COG	1nF	±5%	CL10C102JA8N4N#
7	0.90	50	COG	22pF	±5%	CL10C220JB8N4N#
8	0.90	50	COG	33pF	±5%	CL10C330JB8N4N#
9	0.90	50	COG	68pF	±5%	CL10C680JB8N4N#
10	0.90	50	COG	100pF	±5%	CL10C101JB8N4N#
11	0.90	50	COG	120pF	±5%	CL10C121JB8N4N#
12	0.90	50	COG	150pF	±5%	CL10C151JB8N4N#
13	0.90	50	COG	150pF	±10%	CL10C151KB8N4N#
14	0.90	50	COG	220pF	±5%	CL10C221JB8N4N#
15	0.90	50	COG	330pF	±5%	CL10C331JB8N4N#
16	0.90	50	COG	330pF	±10%	CL10C331KB8N4N#
17	0.90	50	COG	390pF	±5%	CL10C391JB8N4N#
18	0.90	50	COG	470pF	±5%	CL10C471JB8N4N#
19	0.90	50	COG	560pF	±5%	CL10C561JB8N4N#
20	0.90	50	COG	680pF	±5%	CL10C681JB8N4N#
21	0.90	50	COG	820pF	±5%	CL10C821JB8N4N#
22	0.90	50	COG	1.2nF	±5%	CL10C122JB8N4N#
23	0.90	50	COG	1.8nF	±5%	CL10C182JB8N4N#
24	0.90	50	COG	2.2nF	±5%	CL10C222JB8N4N#
25	0.90	50	COG	3.3nF	±5%	CL10C332JB8N4N#
26	0.90	100	COG	100pF	±5%	CL10C101JC8N4N#

Size Code (inch/mm) : 1210/3225

No.	Thickness Max. (mm)	Rated Voltage (Vdc)	TCC	Capacitance	Capacitance Tolerance	Part Number
1	2.70	1000	COG	10nF	±5%	CL32C103JIJN4N#
2	2.70	1000	COG	15nF	±5%	CL32C153JIJN4N#
3	2.80	1000	COG	22nF	±5%	CL32C223JIVN4N#

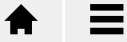

# Normal Capacitors\_High Level II

## Product Lineup (X5R)

Size Code (inch/mm) : 0603/1608, 0805/2012

No.	Thickness Max. (mm)	Rated Voltage (Vdc)	TCC	Capacitance	Capacitance Tolerance	Part Number
1	0.90	6.3	X5R	4.7uF	±10%	CL10A475KQ8N4N#
2	0.90	6.3	X5R	4.7uF	±20%	CL10A475MQ8N4N#
3	0.90	10	X5R	1uF	±10%	CL10A105KP8N4N#
4	0.90	10	X5R	4.7uF	±10%	CL10A475KP8N4N#
5	0.95	10	X5R	10uF	±10%	CL10A106KP8N4Q#
6	0.90	16	X5R	1uF	±10%	CL10A105K08N4N#
7	0.90	25	X5R	1uF	±10%	CL10A105KA8N4N#
8	1.40	6.3	X5R	22uF	±20%	CL21A226MQQN4N#

## Product Lineup (X6S)

Size Code (inch/mm) : 1206/3216

No.	Thickness Max. (mm)	Rated Voltage (Vdc)	TCC	Capacitance	Capacitance Tolerance	Part Number
1	1.90	6.3	X6S	100uF	±20%	CL31X107MQKN4N#

Size Code (inch/mm) : 1210/3225

No.	Thickness Max. (mm)	Rated Voltage (Vdc)	TCC	Capacitance	Capacitance Tolerance	Part Number
1	2.80	2.5	X6S	330uF	±20%	CL32X337MSVN4S#

## Product Lineup (X7R/S)

Size Code (inch/mm) : 0402/1005, 1210/3225

No.	Thickness Max. (mm)	Rated Voltage (Vdc)	TCC	Capacitance	Capacitance Tolerance	Part Number
1	0.33	10	X7R	100nF	±10%	CL03B104KP3N4N#
2	0.33	10	X7S	100nF	±10%	CL03Y104KP3N4N#
3	0.55	10	X7R	470nF	±10%	CL05B474KP5Z4N#
4	0.55	16	X7R	22nF	±10%	CL05B223K05Z4N#
5	0.55	16	X7R	100nF	±10%	CL05B104K05Z4N#
6	0.55	25	X7R	100nF	±10%	CL05B104KA5N4N#
7	0.55	50	X7R	1nF	±10%	CL05B102KB5Z4N#
8	0.55	50	X7R	4.7nF	±10%	CL05B472KB5S4N#
9	0.55	50	X7R	100nF	±10%	CL05B104KB5N4N#
10	0.90	10	X7R	1uF	±10%	CL10B105KP8N4N#
11	0.90	10	X7R	2.2uF	±10%	CL10B225KP8N4N#
12	0.90	16	X7R	1uF	±10%	CL10B105K08N4N#
13	0.90	25	X7R	100nF	±10%	CL10B104KA8Z4N#
14	0.90	25	X7R	220nF	±10%	CL10B224KA8Z4N#
15	0.90	25	X7R	1uF	±10%	CL10B105KA8N4N#

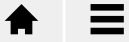

# Normal Capacitors\_High Level II

Size Code (inch/mm) : 0402/1005, 1210/3225

No.	Thickness Max. (mm)	Rated Voltage (Vdc)	TCC	Capacitance	Capacitance Tolerance	Part Number
16	0.90	25	X7R	1uF	±10%	CL10B105KA8Z4N#
17	0.90	50	X7R	1nF	±10%	CL10B102KB8Z4N#
18	0.90	50	X7R	6.8nF	±10%	CL10B682KB8N4N#
19	0.90	50	X7R	47nF	±10%	CL10B473KB8N4N#
20	0.90	50	X7R	100nF	±10%	CL10B104KB8Z4N#
21	0.90	50	X7R	220nF	±10%	CL10B224KB8Z4J#
22	0.90	100	X7R	100nF	±10%	CL10B104KC8N4N#
23	1.50	16	X7S	10uF	±20%	CL21Y106MOYZ4U#
24	1.35	25	X7R	1uF	±10%	CL21B105KAFZ4N#
25	1.35	25	X7R	2.2uF	±10%	CL21B225KAFZ4J#
26	1.45	25	X7S	4.7uF	±10%	CL21Y475KAYN4N#
27	1.35	100	X7R	100nF	±10%	CL21B104KCFZ4N#
28	1.45	100	X7S	1uF	±10%	CL21Y105KCYZ4N#
29	1.90	6.3	X7R	22uF	±10%	CL31B226KQKZ4N#
30	1.90	6.3	X7T	47uF	±20%	CL31Z476MQKN4N#
31	1.80	10	X7R	10uF	±10%	CL31B106KPHZ4N#
32	1.90	10	X7R	22uF	±10%	CL31B226KPKZ4N#
33	1.80	25	X7R	10uF	±10%	CL31B106KAHN4N#
34	1.80	50	X7R	1uF	±10%	CL31B105KBHN4N#
35	1.80	100	X7R	1uF	±10%	CL31B105KCHZ4N#
36	1.80	100	X7R	2.2uF	±10%	CL31B225KCHZ4N#
37	1.80	100	X7S	2.2uF	±10%	CL31Y225KCHZ4N#
38	1.90	100	X7S	4.7uF	±10%	CL31Y475KCK64N#
39	1.90	100	X7S	4.7uF	±10%	CL31Y475KCK6NW#
40	2.80	6.3	X7S	100uF	±20%	CL32Y107MQVN4N#
41	2.80	50	X7R	10uF	±10%	CL32B106KBVZ4N#
42	2.70	100	X7R	2.2uF	±10%	CL32B225KCJZ4N#
43	2.70	100	X7R	4.7uF	±10%	CL32B475KCJZ4N#
44	2.20	100	X7S	4.7uF	±10%	CL32Y475KCIZ4N#
45	2.70	100	X7S	4.7uF	±10%	CL32Y475KCJZ4N#
46	2.80	100	X7S	10uF	±10%	CL32Y106KCVZ4N#

## Product Lineup (X8L)

Size Code (inch/mm) : 1210/3225

No.	Thickness Max. (mm)	Rated Voltage (Vdc)	TCC	Capacitance	Capacitance Tolerance	Part Number
1	2.70	100	X8L	4.7uF	±10%	CL32E475KCJZ4N#

# Molded Frame Capacitors (MFC)

## Features

- Advanced solution beyond standard metal frame capacitor.
- Samsung MFC has a greater reliability than a general MLCC.
- High solder crack resistance at thermal cycling test.
- High board bending strength up to 10mm (specification: 5mm)
- Enhanced moisture resistance by Epoxy molding compound
- Acoustic noise reduction. (piezoelectric effect)
- Low ESR Metal frame plating(Material:Cu,Ni,Pd,Au)

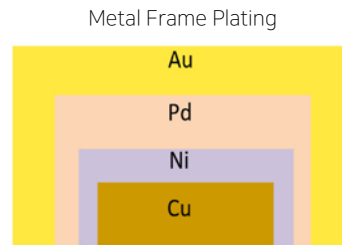
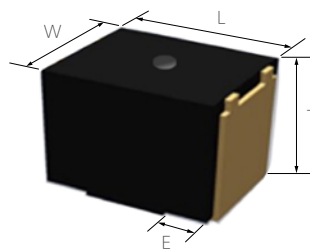
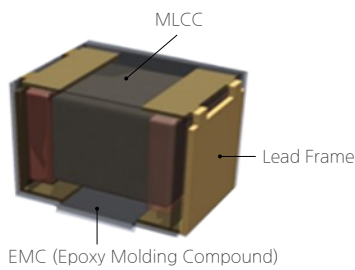

## Application

- Power, DC-DC Converter where bending stress is high and high reliability is necessary.

## Specifications

Samsung P/N	Dimension (mm)			
	L	W	T	E
CL32B225KCDMNWF	3.80±0.10	2.80±0.10	3.35±0.10	0.80±0.15
CL32Y225KCDMNWF	3.80±0.10	2.80±0.10	3.35±0.10	0.80±0.15

### Land Dimension

(Unit : mm)

Chip Size	Chip Tol.	a	b	c	(a+2b)min	(a+2b)max	Wmin	Wmax
1210 (EIA code) MFC	±0.10	2.0~2.2	1.1~1.3	2.30~2.50	4.20	4.80	2.70	2.90

## Product LineUp

Size Code (inch/mm) : 1210/3225

No.	Thickness Max. (mm)	Rated Voltage (Vdc)	TCC	Capacitance	Capacitance Tolerance	Part Number
1	0.45	100	X7S	4.7uF	±10%	CL32Y475KCDMNW#
2	0.45	100	X7R	2.2uF	±10%	CL32B225KCDMNW#

# Land Side Capacitors (LSC) Land Side

## Features

- This can be mounted between the solder balls to deal with thin devices or modules.
- It can reduce the thickness of the module.
- It can quickly supply stable current to high-speed AP of mobile devices.
- In addition it helps remove high-frequency noise, suffering less from external environmental stress.

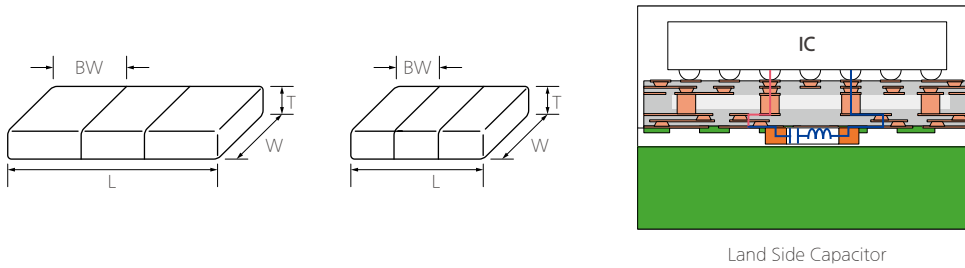

## Application

- Smart Phone, Wearable Devices, IC Package, Module Products

## Structure and Dimensions

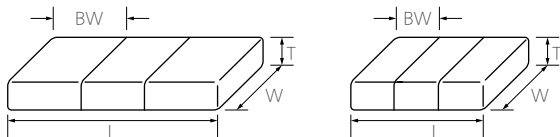

Size Code	Dimension (mm)					EIA (inch)
	L	W	T	Thckness Code	BW	
02	0.40±0.02	0.20±0.02	0.095±0.015	L	0.10±0.03	01005
05	1.00±0.05	0.50±0.05	0.0975±0.0125	L	0.250±0.075	0402
	1.00±0.05	0.50±0.05	0.20±0.02	2	0.25±0.10	0402
L3	0.30±0.03	0.60±0.03	0.18±0.02	W	0.10±0.03	0102
L5	0.52±0.05	1.00±0.05	0.085±0.015	J	0.145±0.050	0204

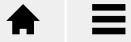

# Land Side Capacitors (LSC)

## Capacitance Table (X5R)

TCC	Size Code (inch/mm)	Rated Voltage (Vdc)	Capacitance									Capacitance Range							
			pF			nF			uF										
			0.1	1	10	100	1	10	100	1	10		100						
X5R (85°C)	0102/0306	25																	22nF - 33nF
	01005/0402	6.3																	51pF - 1nF
	0402/1005	6.3																	220nF - 220nF
X7T (125°C)	0204/0510	2.5																	1uF - 1uF

## Product Lineup (X5R)

Size Code (inch/mm) : 0102/0306

No.	Thickness Max. (mm)	Rated Voltage (Vdc)	TCC	Capacitance	Capacitance Tolerance	Part Number
1	0.235	25	X5R	33nF	±10%	CLL3A333KAYHLN#
2	0.20	25	X5R	22nF	±10%	CLL3A223KAWHLN#

Size Code (inch/mm) : 01005/0402

No.	Thickness Max. (mm)	Rated Voltage (Vdc)	TCC	Capacitance	Capacitance Tolerance	Part Number
1	0.11	6.3	X5R	51pF	±20%	CL02A510MQLHNN#
2	0.11	6.3	X5R	680pF	±20%	CL02A681MQLHNN#
3	0.11	6.3	X5R	1nF	±20%	CL02A102MQLHNN#

Size Code (inch/mm) : 0402/1005

No.	Thickness Max. (mm)	Rated Voltage (Vdc)	TCC	Capacitance	Capacitance Tolerance	Part Number
1	0.10	6.3	X5R	220nF	±20%	CL05A224MQLHEC#

## Product Lineup (X7T)

Size Code (inch/mm) : 0204/0510

No.	Thickness Max. (mm)	Rated Voltage (Vdc)	TCC	Capacitance	Capacitance Tolerance	Part Number
1	0.22	2.5	X7T	1uF	±20%	CLL5Z105MS2HLN#

# High Bending Strength Capacitors

High Bending Strength

## Features

- The mechanical stress on the chip can be absorbed by the characteristic of Soft Termination.
- It is also resistant to stress caused by board bending.

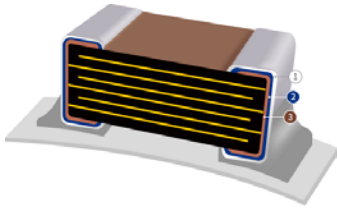

- ① Ni/Sn
- ② Metal/Epoxy Termination
- ③ Cu-Term

## Application

- All Application (Smart Phone, PC, HDD/SSD Board, Tablet, Display, Etc), Power (SMPS, DC-DC Converter), Industrial Application

## Structure and Dimensions

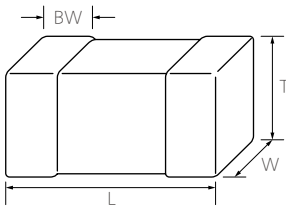

Size Code	Dimension (mm)					EIA (inch)
	L	W	T	Thkckness Code	BW	
03	0.60±0.03	0.30±0.03	0.30±0.03	3	0.15±0.05	0201
05	1.00±0.05	0.50±0.05	0.50±0.05	5	0.25±0.10	0402
10	1.60±0.10	0.80±0.10	0.80±0.10	8	0.30±0.20	0603
21	2.00±0.10	1.25±0.10	0.85±0.10	C	0.50+0.2/-0.3	0805
	2.00±0.10	1.25±0.10	1.25±0.10	F		
	2.00±0.15	1.25±0.15	1.25±0.15	Q		
31	3.20±0.15	1.60±0.15	1.25±0.15	F	0.50±0.30	1206
	3.20±0.20	1.60±0.20	1.60±0.20	H		
32	3.20±0.30	2.50±0.20	1.60±0.10	T	0.60±0.30	1210
	3.20±0.30	2.50±0.20	2.50±0.20	J		
	3.20±0.40	2.50±0.30	2.50±0.30	V		

## Capacitance Table (X5R)

TCC	Size Code (inch/mm)	Rated Voltage (Vdc)	Capacitance										Capacitance Range				
			pF			nF			uF								
			0.1	1	10	100	1	10	100	1	10	100					
X5R (85°C)	0201/0603	10															100nF - 1uF
		6.3															4.7uF - 22uF
	0402/1005	10															2.2uF - 10uF
		6.3															10uF - 10uF
		10															22uF - 22uF

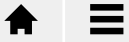

# High Bending Strength Capacitors

## Capacitance Table (X6S)

TCC	Size Code (inch/mm)	Rated Voltage (Vdc)	Capacitance												Capacitance Range				
			pF				nF				uF								
			0.1	1	10	100	1	10	100	1	10	100							
X6S (105°C)	1210/3225	16															■		47uF - 47uF

## Capacitance Table (X7S)

TCC	Size Code (inch/mm)	Rated Voltage (Vdc)	Capacitance												Capacitance Range				
			pF				nF				uF								
			0.1	1	10	100	1	10	100	1	10	100							
X7S (125°C)	0805/2012	16															■		10uF - 10uF
		100															■		220nF / 1uF
	1206/3216	16															■		22uF - 22uF
		25															■		22uF - 22uF
		100															■		2.2uF - 4.7uF
1210/3225	100															■		4.7uF - 10uF	

## Capacitance Table (X7R)

TCC	Size Code (inch/mm)	Rated Voltage (Vdc)	Capacitance												Capacitance Range				
			pF				nF				uF								
			0.1	1	10	100	1	10	100	1	10	100							
X7R (125°C)	0402/1005	10															■		220nF - 470nF
		16															■		22nF - 100nF
		50															■		1nF - 15nF
	0603/1608	25															■		100nF - 1uF
		50															■		1nF - 1uF
		100															■		1nF - 1nF
	0805/2012	25															■		1uF - 2.2uF
		100															■		10nF - 220nF
		250															■		1nF / 22nF
	1206/3216	6.3															■		22uF - 22uF
		10															■		10uF - 22uF
		25															■		4.7uF - 10uF
		35															■		10uF - 10uF
		100															■		1uF - 2.2uF
		250															■		100nF - 100nF
		630															■		1nF - 22nF
	1000															■		1nF - 10nF	
	1210/3225	50															■		4.7uF - 10uF
100																■		2.2uF - 4.7uF	
250																■		220nF - 220nF	
1000																■		22nF - 22nF	

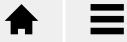

# High Bending Strength Capacitors

## Capacitance Table (X8L)

TCC	Size Code (inch/mm)	Rated Voltage (Vdc)	Capacitance												Capacitance Range				
			pF				nF				uF								
			0.1	1	10	100	1	10	100	1	10	100							
X8L (150°C)	1210/3225	100																	4.7uF - 4.7uF

## Product Lineup (X5R)

Size Code (inch/mm) : 0201/0603

No.	Thickness Max. (mm)	Rated Voltage (Vdc)	TCC	Capacitance	Capacitance Tolerance	Part Number
1	0.33	10	X5R	100nF	±10%	CL03A104KP3ZNN#
2	0.35	10	X5R	1uF	±20%	CL03A105MP3ZSN#

Size Code (inch/mm) : 0402/1005

No.	Thickness Max. (mm)	Rated Voltage (Vdc)	TCC	Capacitance	Capacitance Tolerance	Part Number
1	0.57	10	X5R	2.2uF	±10%	CL05A225KP5ZSN#
2	0.65	6.3	X5R	4.7uF	±20%	CL05A475MQ5ZRN#
3	0.65	10	X5R	4.7uF	±10%	CL05A475KP5ZRN#
4	0.70	6.3	X5R	10uF	±20%	CL05A106MQ5ZUN#
5	0.70	10	X5R	10uF	±20%	CL05A106MP5ZUN#

Size Code (inch/mm) : 0603/1608

No.	Thickness Max. (mm)	Rated Voltage (Vdc)	TCC	Capacitance	Capacitance Tolerance	Part Number
1	0.95	6.3	X5R	10uF	±20%	CL10A106MQ8ZQN#
2	1.05	10	X5R	22uF	±20%	CL10A226MP8ZUN#

## Product Lineup (X6S)

Size Code (inch/mm) : 1210/3225

No.	Thickness Max. (mm)	Rated Voltage (Vdc)	TCC	Capacitance	Capacitance Tolerance	Part Number
1	2.80	16	X6S	47uF	±10%	CL32X476KOVZNW#

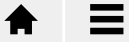

# High Bending Strength Capacitors

## Product Lineup (X7S)

Size Code (inch/mm) : 0805/2012

No.	Thickness Max. (mm)	Rated Voltage (Vdc)	TCC	Capacitance	Capacitance Tolerance	Part Number
1	1.35	100	X7S	220nF	±10%	CL21Y224KCFW6#
2	1.45	100	X7S	1uF	±10%	CL21Y105KCYZ4N#
3	1.50	16	X7S	10uF	±20%	CL21Y106MOYZ4U#

Size Code (inch/mm) : 1206/3216

No.	Thickness Max. (mm)	Rated Voltage (Vdc)	TCC	Capacitance	Capacitance Tolerance	Part Number
1	1.80	100	X7S	2.2uF	±10%	CL31Y225KCHZ4N#
2	1.90	16	X7S	22uF	±10%	CL31Y226KOK64N#
3	1.90	25	X7S	22uF	±20%	CL31Y226MAK64N#
4	1.90	100	X7S	4.7uF	±10%	CL31Y475KCK64N#

Size Code (inch/mm) : 1210/3225

No.	Thickness Max. (mm)	Rated Voltage (Vdc)	TCC	Capacitance	Capacitance Tolerance	Part Number
1	2.20	100	X7S	4.7uF	±10%	CL32Y475KCIZ4N#
2	2.70	100	X7S	4.7uF	±10%	CL32Y475KCJZ4N#
3	2.80	100	X7S	10uF	±10%	CL32Y106KCV64N#
4	2.80	100	X7S	10uF	±10%	CL32Y106KCVZ4N#

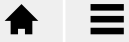

# High Bending Strength Capacitors

## Product Lineup (X7R)

Size Code (inch/mm) : 0402/1005

No.	Thickness Max. (mm)	Rated Voltage (Vdc)	TCC	Capacitance	Capacitance Tolerance	Part Number
1	0.55	10	X7R	470nF	±10%	CL05B474KP5Z4N#
2	0.55	16	X7R	100nF	±10%	CL05B104K05Z4N#
3	0.55	16	X7R	22nF	±10%	CL05B223K05Z4N#
4	0.55	50	X7R	1nF	±10%	CL05B102KB5Z4N#
5	0.55	50	X7R	2.2nF	±10%	CL05B222KB5Z4N#

Size Code (inch/mm) : 0603/1608

No.	Thickness Max. (mm)	Rated Voltage (Vdc)	TCC	Capacitance	Capacitance Tolerance	Part Number
1	0.70	100	X7R	10nF	±10%	CL21B103KC6Z4N#
2	0.90	25	X7R	100nF	±10%	CL10B104KA8Z4N#
3	0.90	25	X7R	1uF	±10%	CL10B105KA8Z4N#
4	0.90	25	X7R	220nF	±10%	CL10B224KA8Z4N#
5	0.90	50	X7R	100nF	±10%	CL10B104KB8ZW6#
6	0.90	50	X7R	100nF	±10%	CL10B104KB8Z4N#
7	0.90	50	X7R	1nF	±10%	CL10B102KB8Z4N#
8	0.90	50	X7R	220nF	±10%	CL10B224KB8Z4J#
9	0.95	50	X7R	1uF	±10%	CL10B105KB8Z4Q#

Size Code (inch/mm) : 0805/2012

No.	Thickness Max. (mm)	Rated Voltage (Vdc)	TCC	Capacitance	Capacitance Tolerance	Part Number
1	0.95	250	X7R	1nF	±10%	CL21B102KECSW6#
2	1.35	25	X7R	1uF	±10%	CL21B105KAFZ4N#
3	1.35	25	X7R	2.2uF	±10%	CL21B225KAFZ4J#
4	1.35	100	X7R	100nF	±10%	CL21B104KCFZ4N#



# High Bending Strength Capacitors

Size Code (inch/mm) : 1206/3216

No.	Thickness Max. (mm)	Rated Voltage (Vdc)	TCC	Capacitance	Capacitance Tolerance	Part Number
1	1.40	630	X7R	10nF	±10%	CL31B103KHFSW6#
2	1.40	630	X7R	1nF	±10%	CL31B102KHFSW6#
3	1.45	250	X7R	22nF	±10%	CL21B223KEY64N#
4	1.80	10	X7R	10uF	±10%	CL31B106KPHZ4N#
5	1.80	25	X7R	10uF	±10%	CL31B106KAHZW6#
6	1.80	25	X7R	4.7uF	±10%	CL31B475KAHZW6#
7	1.80	35	X7R	10uF	±10%	CL31B106KLHSNN#
8	1.80	100	X7R	1uF	±10%	CL31B105KCHZ4N#
9	1.80	100	X7R	2.2uF	±10%	CL31B225KCHZ4N#
10	1.80	250	X7R	100nF	±10%	CL31B104KEHSW6#
11	1.80	630	X7R	22nF	±10%	CL31B223KHH64N#
12	1.80	1000	X7R	10nF	±10%	CL31B103KIHZ4N#
13	1.90	6.3	X7R	22uF	±10%	CL31B226KQKZ4N#
14	1.90	10	X7R	22uF	±10%	CL31B226KPKZ4N#

Size Code (inch/mm) : 1210/3225

No.	Thickness Max. (mm)	Rated Voltage (Vdc)	TCC	Capacitance	Capacitance Tolerance	Part Number
1	2.00	250	X7R	220nF	±10%	CL32B224KEU64N#
2	2.70	50	X7R	10uF	±10%	CL32B106KBJZW6#
3	2.70	50	X7R	4.7uF	±10%	CL32B475KBJSW6#
4	2.70	100	X7R	2.2uF	±10%	CL32B225KCJZW6#
5	2.70	100	X7R	2.2uF	±10%	CL32B225KCJZ4N#
6	2.70	100	X7R	4.7uF	±10%	CL32B475KCJZ4N#
7	2.80	50	X7R	10uF	±10%	CL32B106KBVZ4N#

## Product Lineup (X8L)

Size Code (inch/mm) : 1210/3225

No.	Thickness Max. (mm)	Rated Voltage (Vdc)	TCC	Capacitance	Capacitance Tolerance	Part Number
1	2.70	100	X8L	4.7uF	±10%	CL32E475KCJZ4N#

# Low Acoustic Noise Capacitors

Low Acoustic Noise

## Features

- MLCC tremors can occur due to piezoelectric phenomena in electronic devices.
- These tremors are transmitted to the substrate, causing the substrate to tremble, causing audible noise (20Hz~20kHz).
- Low Acoustic Noise products are a solution that can effectively reduce this noise.

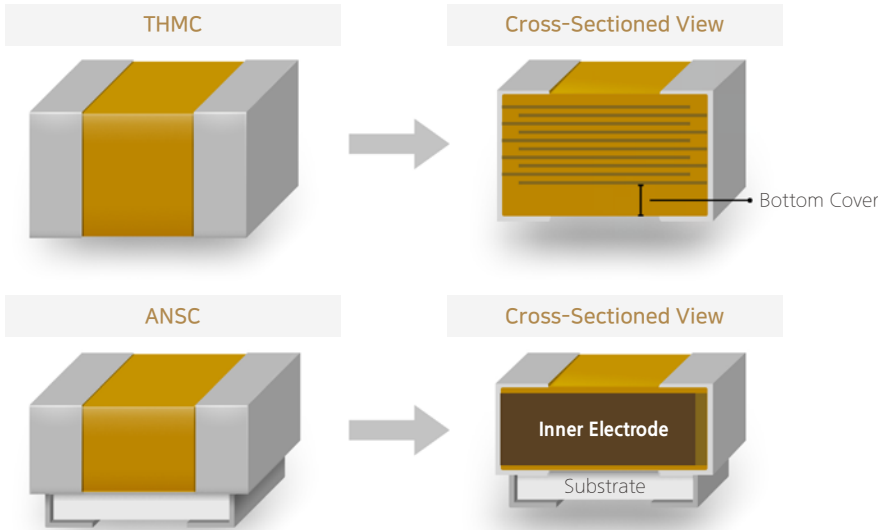

\* THMC : Thick Horizontally Mounted Capacitor  
 \* ANSC : Acoustic Noise Suppressed Capacitor

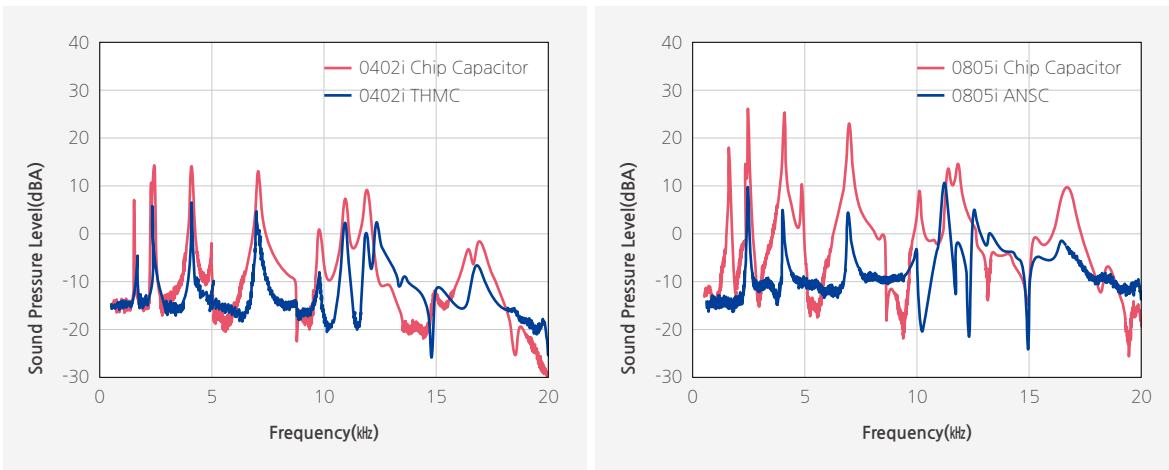

[Comparison of Noise Reduction Effects]

# Low Acoustic Noise Capacitors

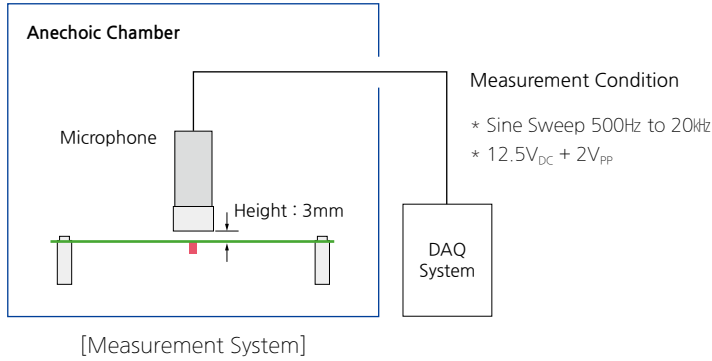

## Application

- All Application (Smart Phone, PC, HDD/SSD Board, Tablet, Display, Etc), Power (SMPS, DC-DC Converter), Industrial Application

## Structure and Dimensions

Low Acoustic Noise Capacitor\_THMC

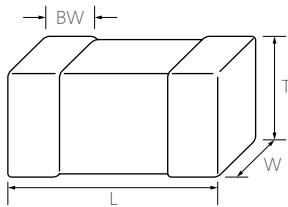

Size Code	Dimension (mm)					EIA (inch)
	L	W	T	Thckness Code	BW	
05	1.00±0.25	0.50±0.25	0.60±0.25	6	0.25±0.10	0402
	1.00±0.15	0.50±0.15	0.70±0.10	7		
	1.00±0.20	0.50±0.20	0.80±0.10	8		
	1.00±0.20	0.50±0.20	0.90±0.10	9		
10	1.60±0.30	0.80±0.30	0.90±0.10	9	0.30±0.20	0603
	1.60±0.25	0.80±0.25	0.85±0.10	C		
	1.60±0.20	0.80±0.20	1.10±0.10	E		
	1.60±0.25	0.80±0.25	1.15±0.10	M		
	1.60±0.10	0.80±0.10	0.95±0.10	N		
21	2.00±0.20	1.25±0.20	1.10±0.10	E	0.50+0.20/-0.30	0805

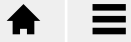

# Low Acoustic Noise Capacitors

## Capacitance Table (X5R)

TCC	Size Code (inch/mm)	Rated Voltage (Vdc)	Capacitance									Capacitance Range													
			pF			nF			uF																
			0.1	1	10	100	1	10	100	1	10		100												
X5R (85°C)	0402/1005	6.3																						10uF - 10uF	
		10																							2.2uF - 10uF
		16																							2.2uF - 2.2uF
		25																							2.2uF - 2.2uF
	0603/1608	6.3																							10uF - 47uF
		10																							4.7uF - 22uF
		25																							10uF - 10uF
	0805/2012	25																							10uF - 10uF

## Capacitance Table (X6S)

TCC	Size Code (inch/mm)	Rated Voltage (Vdc)	Capacitance									Capacitance Range													
			pF			nF			uF																
			0.1	1	10	100	1	10	100	1	10		100												
X6S (105°C)	0402/1005	2.5																							20uF - 20uF
	0603/1608	6.3																							22uF - 22uF

## Product Lineup (X5R)

Size Code (inch/mm) : 0402/1005

No.	Thickness Max. (mm)	Rated Voltage (Vdc)	TCC	Capacitance	Capacitance Tolerance	Part Number	Remarks
1	0.65	10	X5R	4.7uF	±20%	CL05A475MP5NRB#	T-HMC
2	0.65	10	X5R	4.7uF	±20%	CL05A475MP5ZRB#	T-HMC
3	0.65	16	X5R	2.2uF	±20%	CL05A225M05ZOB#	T-HMC
4	0.65	25	X5R	2.2uF	±20%	CL05A225MA5NOB#	T-HMC
5	0.65	25	X5R	2.2uF	±20%	CL05A225MA5QOB#	T-HMC
6	0.80	10	X5R	10uF	±20%	CL05A106MP7NUB#	T-HMC
7	0.80	10	X5R	10uF	±20%	CL05A106MP7ZUB#	T-HMC
8	0.80	10	X5R	2.2uF	±10%	CL05A225KP7NSB#	T-HMC
9	0.80	10	X5R	4.7uF	±20%	CL05A475MP7NRB#	T-HMC
10	0.90	6.3	X5R	10uF	±20%	CL05A106MQ8NUB#	T-HMC
11	0.90	10	X5R	10uF	±20%	CL05A106MP8NUB#	T-HMC
12	1.00	10	X5R	10uF	±20%	CL05A106MP9NUB#	T-HMC

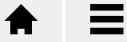

# Low Acoustic Noise Capacitors

Size Code (inch/mm) : 0603/1608

No.	Thickness Max. (mm)	Rated Voltage (Vdc)	TCC	Capacitance	Capacitance Tolerance	Part Number	Remarks
1	0.80	10	X5R	22uF	±20%	CL10A226MP7ZZB#	T-HMC
2	0.95	6.3	X5R	22uF	±20%	CL10A226MQCNUB#	T-HMC
3	0.95	10	X5R	22uF	±20%	CL10A226MPCNUB#	T-HMC
4	1.00	10	X5R	22uF	±20%	CL10A226MP9NZB#	T-HMC
5	1.00	10	X5R	4.7uF	±10%	CL10A475KP9NHB#	T-HMC
6	1.05	6.3	X5R	10uF	±20%	CL10A106MQNNHB#	T-HMC
7	1.05	10	X5R	10uF	±20%	CL10A106MPNNHB#	T-HMC
8	1.20	6.3	X5R	47uF	±20%	CL10A476MQENRB#	T-HMC
9	1.20	25	X5R	10uF	±20%	CL10A106MAEURN#	ANSC-B
10	1.25	6.3	X5R	22uF	±20%	CL10A226MQMNUB#	T-HMC
11	1.25	10	X5R	22uF	±20%	CL10A226MPMNUB#	T-HMC

Size Code (inch/mm) : 0805/2012

No.	Thickness Max. (mm)	Rated Voltage (Vdc)	TCC	Capacitance	Capacitance Tolerance	Part Number	Remarks
1	1.20	25	X5R	10uF	±10%	CL21A106KAENRB#	T-HMC
2	2.00	25	X5R	10uF	±10%	CL21A106KAUUNN#	ANSC-A

## Product Lineup (X6S)

Size Code (inch/mm) : 0402/1005

No.	Thickness Max. (mm)	Rated Voltage (Vdc)	TCC	Capacitance	Capacitance Tolerance	Part Number	Remarks
1	0.85	2.5	X6S	20uF	±20%	CL05X206MS6N6B#	T-HMC

Size Code (inch/mm) : 0603/1608

No.	Thickness Max. (mm)	Rated Voltage (Vdc)	TCC	Capacitance	Capacitance Tolerance	Part Number	Remarks
1	1.20	6.3	X6S	22uF	±20%	CL10X226MQEURN#	ANSC-B

# Low ESL Capacitors Low ESL

## Features

- MLCCs with low equivalent series inductance (ESL) can be used in circuits with limited mounting area, as a small quantity of such MLCCs can sufficiently replace high-speed IC MLCCs.

Multiple MLCC Used for Energy Transfer

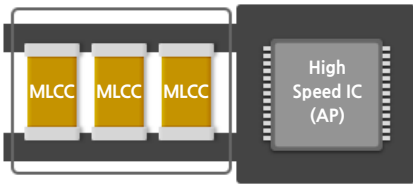

Multiple MLCCs Used

Low ESL MLCC

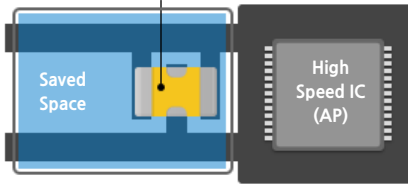

Low ESL MLCC Used

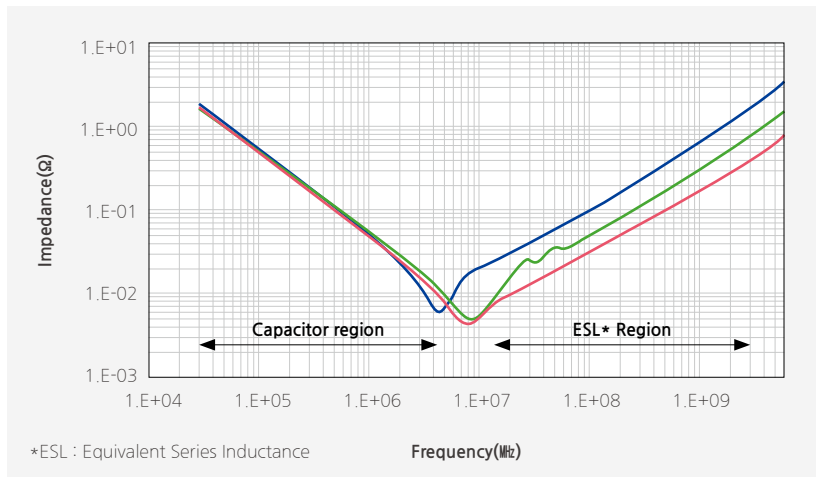

[Comparison between Impedance-Frequency Characteristics]

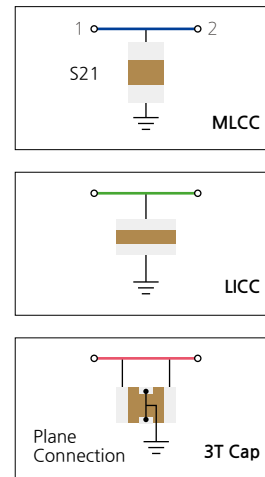

## Application

- All Application (Smart Phone, Wearable Devices, IC Package, PC)

# Low ESL Capacitors

## Structure and Dimensions

Low ESL Capacitor\_Reverse

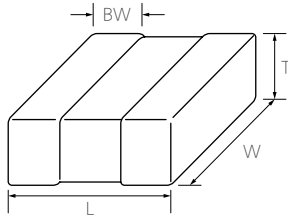

Size Code	Dimension (mm)					EIA (inch)
	L	W	T	Thckness Code	BW	
L5	0.52±0.05	1.00±0.05	0.20±0.02	2	0.18±0.06	0204
	0.52±0.05	1.00±0.05	0.30±0.05	3	0.18±0.06	
01	0.80±0.15	1.60±0.20	0.50±0.05/-0.10	5	0.25±0.15	0306

Low ESL Capacitor\_3T

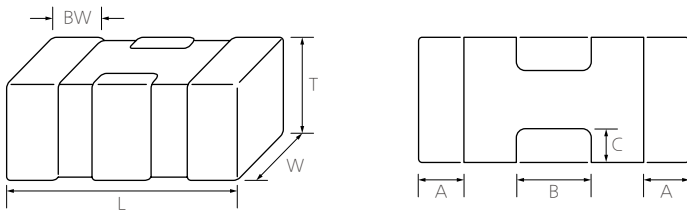

Size Code	Dimension (mm)							EIA (inch)
	L	W	T	Thckness Code	BW			
					A	B	C	
05	1.05±0.05	0.65±0.05	0.45±0.05	5	0.17±0.10	0.35±0.10	0.15±0.10	0402
	1.10±0.15	0.60±0.05	0.60±0.05	6	0.20±0.10	0.35±0.10	0.15±0.10	
	1.00±0.15	0.50±0.15	0.30±0.09	B	0.20±0.10	0.35±0.10	0.15±0.10	
19	1.20±0.05	0.90±0.05	0.75±0.05	7	0.15±0.10	0.50±0.10	0.20±0.10	0503
	1.20±0.05	0.90±0.05	0.60±0.05	A	0.15±0.10	0.50±0.10	0.20±0.10	

Low ESL Capacitor\_8T

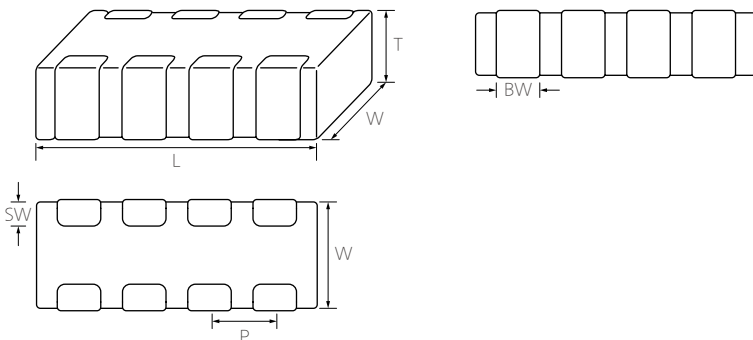

Size Code	Dimension (mm)						EIA (inch)	
	L	W	T	Thckness Code	BW	SW		P
10	1.60±0.10	0.80±0.10	0.5±0.05/-0.1	5	0.25±0.10	0.15±0.10	0.40±0.10	0603



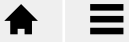

# Low ESL Capacitors

## Product Lineup (X5R\_3T)

Size Code (inch/mm) : 0402/1005

No.	Thickness Max. (mm)	Rated Voltage (Vdc)	TCC	Capacitance	Capacitance Tolerance	Part Number	Remarks
1	0.39	4	X5R	6.7uF	±20%	CL05A675MRBNWR#	3T(Low ESL)
2	0.50	4	X5R	4.3uF	±20%	CL05A435MR5NWN#	3T(Low ESL)
3	0.65	4	X5R	11uF	±20%	CL05A116MR6DWR#	3T(Low ESL)
4	0.65	4	X5R	15uF	±20%	CL05A156MR6NWR#	3T(Low ESL)

Size Code (inch/mm) : 0503/1209

No.	Thickness Max. (mm)	Rated Voltage (Vdc)	TCC	Capacitance	Capacitance Tolerance	Part Number	Remarks
1	0.55	4	X5R	22uF	±20%	CL19A226MR3NWU#	3T(Low ESL)
2	0.65	4	X5R	15uF	±20%	CL19A156MRANWN#	3T(Low ESL)
3	0.65	4	X5R	22uF	±20%	CL19A226MR5NWU#	3T(Low ESL)
4	0.65	4	X5R	22uF	±20%	CL19A226MRANWN#	3T(Low ESL)
5	0.80	4	X5R	22uF	±20%	CL19A226MR7IWW#	3T(Low ESL)
6	0.80	4	X5R	22uF	±20%	CL19A226MR7IWN#	3T(Low ESL)

## Product Lineup (X6S\_3T)

Size Code (inch/mm) : 0402/1005

No.	Thickness Max. (mm)	Rated Voltage (Vdc)	TCC	Capacitance	Capacitance Tolerance	Part Number	Remarks
1	0.50	2.5	X6S	4.3uF	±20%	CL05X435MS5NWW#	3T(Low ESL)
2	0.50	2.5	X6S	4.3uF	±20%	CL05X435MS5NWN#	3T(Low ESL)

## Product Lineup (X6T\_3T)

Size Code (inch/mm) : 0402/1005

No.	Thickness Max. (mm)	Rated Voltage (Vdc)	TCC	Capacitance	Capacitance Tolerance	Part Number	Remarks
1	0.39	2.5	X6T	6.7uF	±20%	CL05W675MSBNWR#	3T(Low ESL)

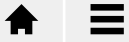

# Low ESL Capacitors

## Product Lineup (X7S\_8T)

Size Code (inch/mm) : 0603/1608

No.	Thickness Max. (mm)	Rated Voltage (Vdc)	TCC	Capacitance	Capacitance Tolerance	Part Number	Remarks
1	0.55	4V	X7S	2.2uF	±20%	CL10Y225MR5NUN#	8T(Low ESL)

## Product Lineup (X5R\_Reverse)

Size Code (inch/mm) : 0204/0510

No.	Thickness Max. (mm)	Rated Voltage (Vdc)	TCC	Capacitance	Capacitance Tolerance	Part Number	Remarks
1	0.10	2.5	X5R	550nF	±20%	CLL5A554MSJHLC#	Reverse (Low ESL)
2	0.10	4	X5R	220nF	±20%	CLL5A224MRJHLC#	Reverse (Low ESL)

## Product Lineup (X6S\_Reverse)

Size Code (inch/mm) : 0204/0510

No.	Thickness Max. (mm)	Rated Voltage (Vdc)	TCC	Capacitance	Capacitance Tolerance	Part Number	Remarks
1	0.10	2.5	X6S	470nF	±20%	CLL5X474MSJHLC#	Reverse (Low ESL)
2	0.35	4	X6S	1uF	±20%	CLL5X105MR3NLN#	Reverse (Low ESL)

## Product Lineup (X7S\_Reverse)

Size Code (inch/mm) : 0306/0816

No.	Thickness Max. (mm)	Rated Voltage (Vdc)	TCC	Capacitance	Capacitance Tolerance	Part Number	Remarks
1	0.55	4	X7S	1uF	±20%	CL01Y105MR5NLN#	Reverse (Low ESL)

# Application Guide

## Smartphone / Tablet

As smartphone has high-performance hardware functions to provide enhanced user experience, various voltage regulators are required for each IC. Power management system includes several PMICs as well as charging system with external passive components.

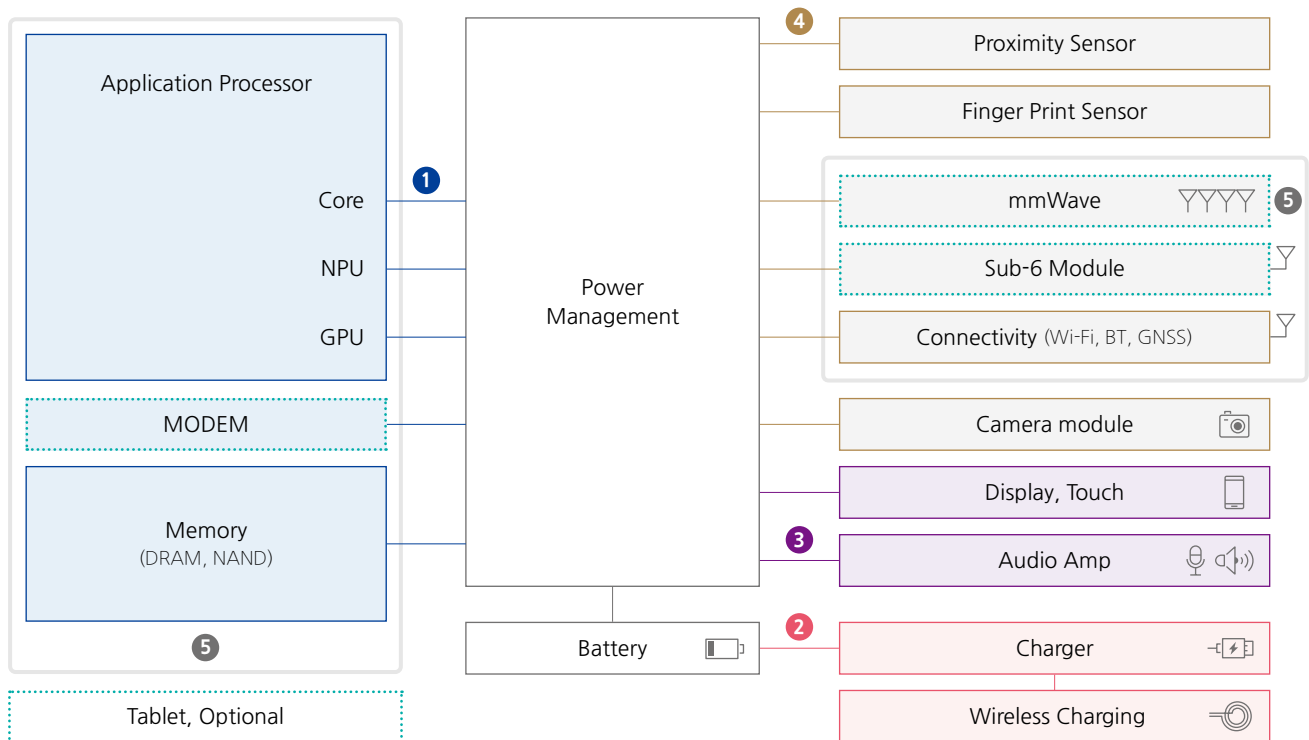

Noise Filtering, Stable Power Delivery	High Bending Strength	Middle & High Freq. Noise	Audible Noise	High Freq. Noise, Limited Space
Normal	Soft Termination	Low ESL	Low Acoustic	LSC
<ul style="list-style-type: none"> <li>1 High C</li> <li>2 3 10V ↑</li> <li>4 Low Profile</li> </ul>	<ul style="list-style-type: none"> <li>2 4 2mm ↑</li> </ul>	<ul style="list-style-type: none"> <li>1 3T</li> </ul>	<ul style="list-style-type: none"> <li>2 THMC, ANSC</li> </ul>	<ul style="list-style-type: none"> <li>5 Low Profile</li> </ul>

# Application Guide

## Laptop

Laptop consist of various form factors and functions by models in consideration of the needs of various customers. In order to implement those functions, many of such function blocks as Memory, Storage, Wi-Fi, are organically connected around the CPU module, and require various power sources. In accordance with the recent trend of high performance, miniaturization and sliming of the sets, passive components are being developed with a focus on high temperature and high capacitance.

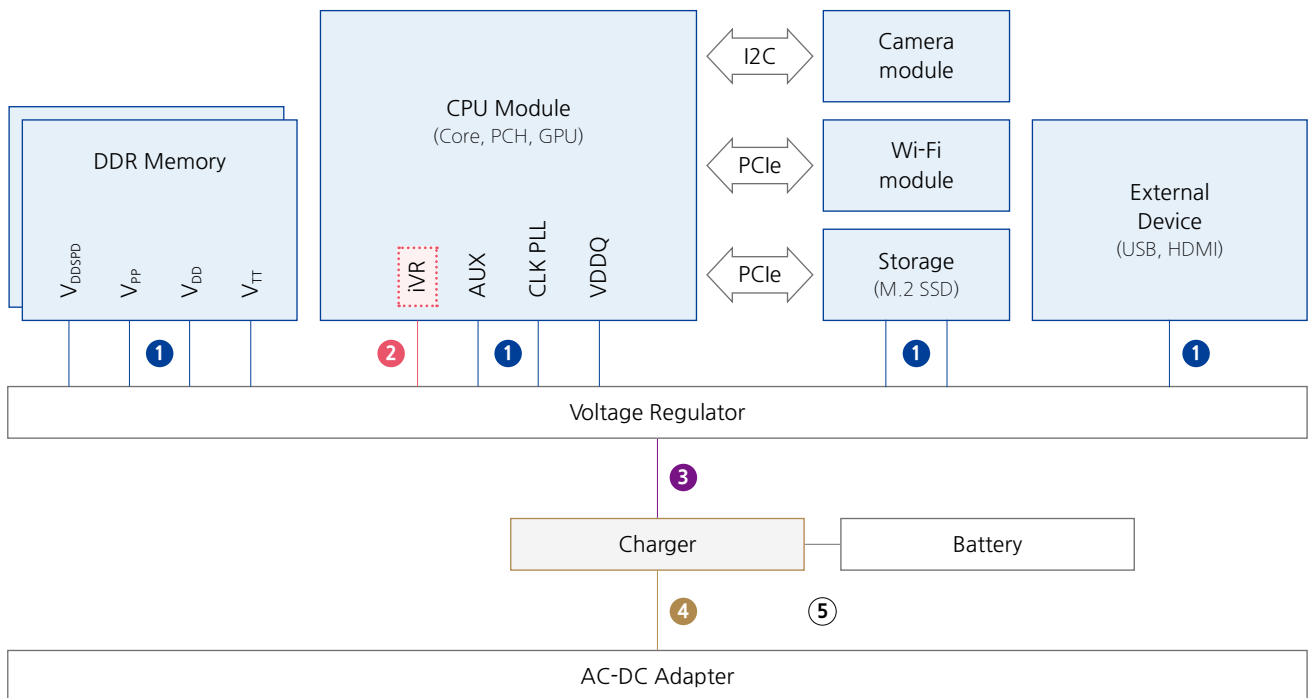

Noise Filtering, Stable Power Delivery	High Bending Strength	Middle & High Freq. Noise	Audible Noise
Normal	Soft Termination	Low ESL	Low Acoustic
① High C ③ ④ 10V ↑	④ 2mm ↑	② 3T, 8T	⑤ THMC, ANSC

# Application Guide

## Server

In recent years, many technologies with upgraded performance, such as high-performance CPU, PCIe 5.0, and DDR5 are being applied to servers. Since such a high-performance server consumes a large amount of current during operation and generates a lot of heat to deteriorate the operation environment, high reliability of the components is required. CPU power line consuming a large amount of currents requires many small-sized and high-capacitance MLCCs to lower the impedance, and the components for high-temperature in the high-temperature environment around CPU.

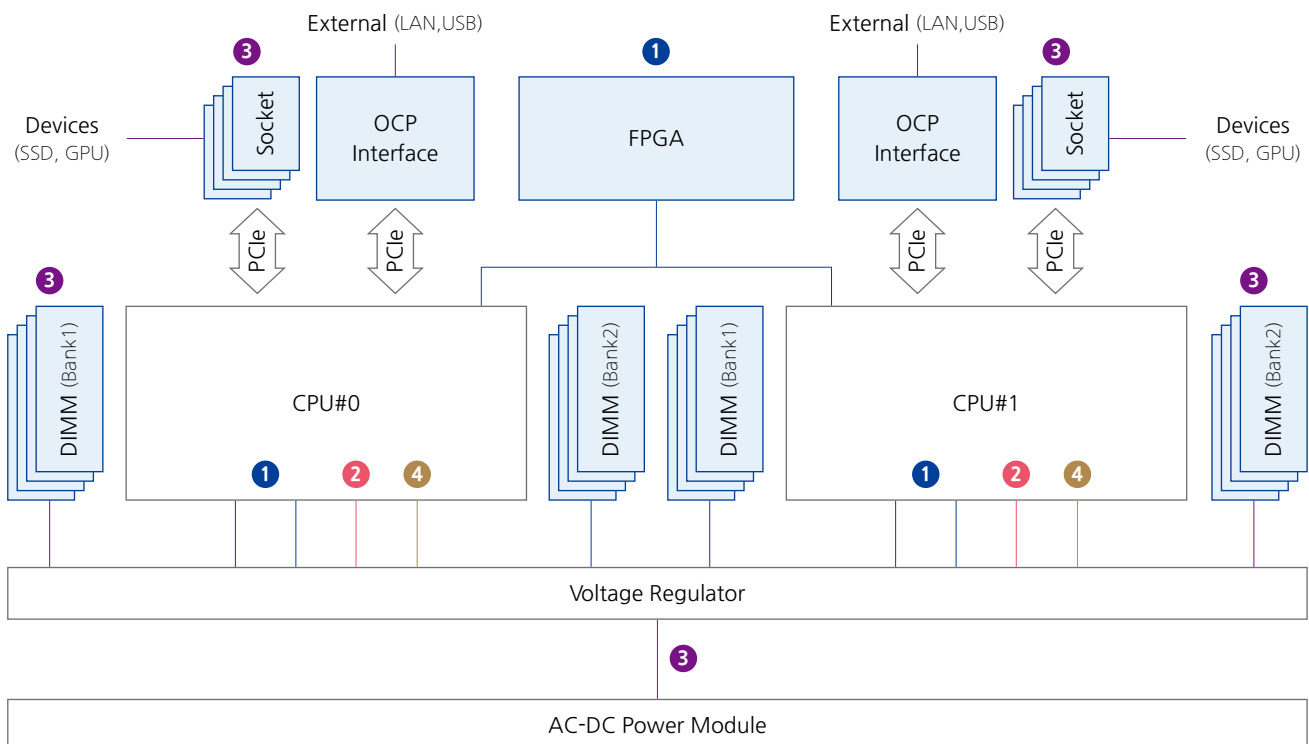

Noise Filtering, Stable Power Delivery	High Bending Strength	Middle & High Freq. Noise
<b>Normal</b>	<b>Soft Termination</b>	<b>Low ESL</b>
1 High C 3 16V ↑ 4 High Temp. (High Level I)	3 3mm ↑	2 3T, 8T

# Application Guide

## Network (Base Station)

RUs are required to be small, light-weight and highly reliable because most of them are exposed to the sunlight being installed on towers or building roofs. With the introduction of 5G, high-integrated and high-performance FPGA/DSP are being used for network equipment to cope with the demand of faster data processing speed and to process the data traffic surge. Accordingly, the demand for high-capacitance MLCCs for stable power supply to high-performance ICs is increasing.

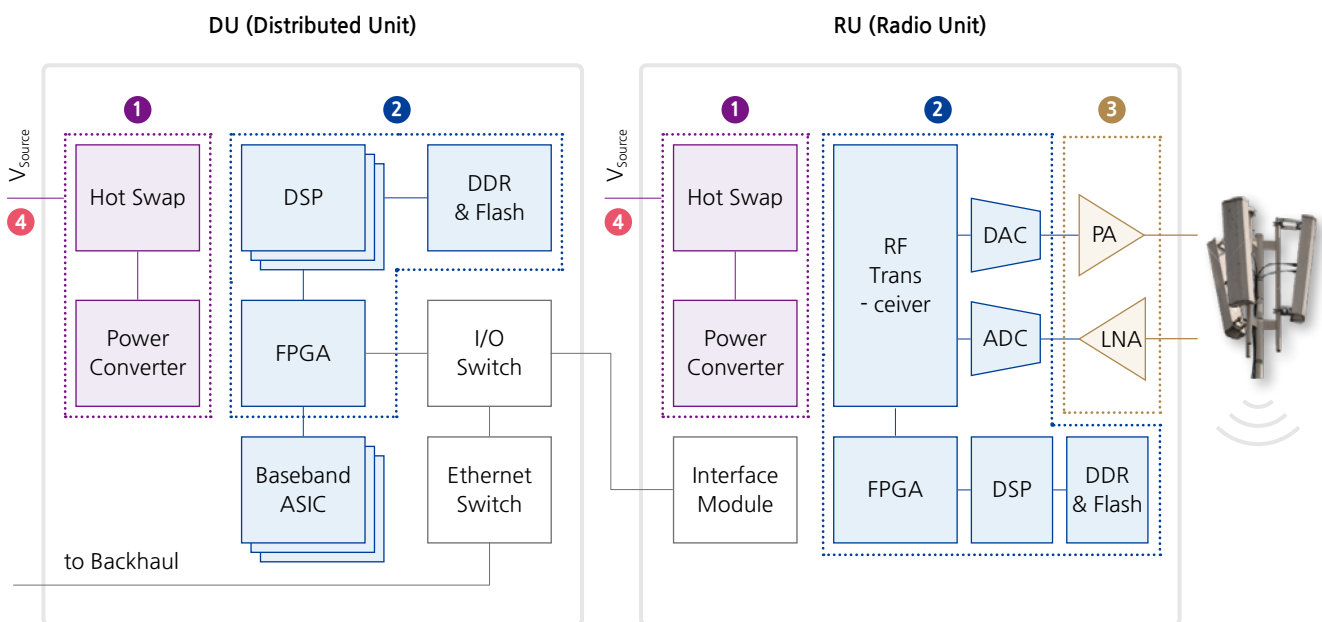

Noise Filtering,  
Stable Power  
Delivery

High Bending  
Strength

Normal

Soft Termination

- 1 3 High Volt.
- 1 2 3 High C
- 3 High Temp.

(High Level I)

- 4 3mm ↑

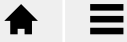

# Reliability Test Conditions

No.	Item	Performance	Test condition																												
1	Appearance	No abnormal exterior appearance	Visual Inspection through Microscope (x10)																												
2	Insulation resistance	10,000MΩ min. or 500MΩ·μF min. (or 100MΩ·μF) product whichever is smaller (Rated voltage ≤16V :10,000MΩ min. or 100MΩ·μF min. product whichever is smaller)	Apply the rated voltage for 60 ~ 120sec. Rated voltage > 500V: Insulation Resistance shall be measured with 500±50Vdc																												
3	Withstanding voltage	No dielectric breakdown or mechanical breakdown	Apply the specified voltage* for 1~5 sec. Charge / Discharge current limit: 50mA max. * CLASS I (Rated Voltage < 100V) : 300% of the rated Voltage CLASS II (Rated Voltage < 100V) : 250% of the rated Voltage  In the case of Vr ≥100V products, following condition should be applied. 100V≤Rated Voltage < 500V : 250% of the rated Voltage 500V≤Rated Voltage < 1000V :150% of the rated Voltage Rated Voltage ≥1000V :120% of the rated Voltage																												
4	Capacitance	Class I	Within the specified tolerance																												
		Class II	Within the specified tolerance																												
5	Q	Capacitance ≥30pF : Q ≥ 1,000 < 30pF : Q ≥ 400+20×C ( C : Capacitance )	<p><b>Class I</b></p> <table border="1"> <thead> <tr> <th>Capacitance</th> <th>Frequency</th> <th>Voltage</th> </tr> </thead> <tbody> <tr> <td>≤1,000pF</td> <td>1kHz±10%</td> <td rowspan="2">0.5~5Vrms</td> </tr> <tr> <td>&gt;1,000pF</td> <td>1kHz±10%</td> </tr> </tbody> </table> <p><b>Class II</b></p> <table border="1"> <thead> <tr> <th>Capacitance</th> <th>Frequency</th> <th>Voltage</th> </tr> </thead> <tbody> <tr> <td>≤10μF</td> <td>1kHz±10%</td> <td>1.0±0.2Vrms</td> </tr> <tr> <td>&gt;10μF</td> <td>120Hz±20%</td> <td>0.5±0.1Vrms</td> </tr> </tbody> </table> <p><b>Exception</b></p> <table border="1"> <thead> <tr> <th>Capacitance</th> <th>Frequency</th> <th>Voltage</th> </tr> </thead> <tbody> <tr> <td>0201 (0603) size 0.22μF≤C≤10μF Less than 10V</td> <td rowspan="3">1kHz±10%</td> <td rowspan="3">0.5±0.1Vrms</td> </tr> <tr> <td>0402 (1005) size, 2.2μF≤C≤10μF Less than 25V</td> </tr> <tr> <td>0603 (1608) size, 10μF Less than 25V</td> </tr> <tr> <td>05J105KP5N3* 05J105KQ5N3* 03A105M03NR* 10B225KP8* 21A475KQQ* 21A106KQQ* 21A625KPQ* 21X106MRC* 21X106KQQ* 21B106KQQ*</td> <td></td> <td></td> </tr> </tbody> </table>	Capacitance	Frequency	Voltage	≤1,000pF	1kHz±10%	0.5~5Vrms	>1,000pF	1kHz±10%	Capacitance	Frequency	Voltage	≤10μF	1kHz±10%	1.0±0.2Vrms	>10μF	120Hz±20%	0.5±0.1Vrms	Capacitance	Frequency	Voltage	0201 (0603) size 0.22μF≤C≤10μF Less than 10V	1kHz±10%	0.5±0.1Vrms	0402 (1005) size, 2.2μF≤C≤10μF Less than 25V	0603 (1608) size, 10μF Less than 25V	05J105KP5N3* 05J105KQ5N3* 03A105M03NR* 10B225KP8* 21A475KQQ* 21A106KQQ* 21A625KPQ* 21X106MRC* 21X106KQQ* 21B106KQQ*		
	Capacitance	Frequency	Voltage																												
≤1,000pF	1kHz±10%	0.5~5Vrms																													
>1,000pF	1kHz±10%																														
Capacitance	Frequency	Voltage																													
≤10μF	1kHz±10%	1.0±0.2Vrms																													
>10μF	120Hz±20%	0.5±0.1Vrms																													
Capacitance	Frequency	Voltage																													
0201 (0603) size 0.22μF≤C≤10μF Less than 10V	1kHz±10%	0.5±0.1Vrms																													
0402 (1005) size, 2.2μF≤C≤10μF Less than 25V																															
0603 (1608) size, 10μF Less than 25V																															
05J105KP5N3* 05J105KQ5N3* 03A105M03NR* 10B225KP8* 21A475KQQ* 21A106KQQ* 21A625KPQ* 21X106MRC* 21X106KQQ* 21B106KQQ*																															
Tanδ	Class II	<p><b>1. Characteristic : A (X5R)</b></p> <table border="1"> <thead> <tr> <th>Rated Voltage</th> <th>Spec</th> </tr> </thead> <tbody> <tr> <td>50V /35V</td> <td>0.025 max / 0.05 max*</td> </tr> <tr> <td>25V</td> <td>0.025 max / 0.05 max* / 0.10 max*</td> </tr> <tr> <td>16V</td> <td>0.035 max / 0.10 max*</td> </tr> <tr> <td>≤10</td> <td>0.035 max / 0.10 max*</td> </tr> </tbody> </table> <p><b>2. Characteristic :B (X7R), X (X6S), Y (X7S)</b></p> <table border="1"> <thead> <tr> <th>Rated Voltage</th> <th>Spec</th> </tr> </thead> <tbody> <tr> <td>50V≥/ 35V / 25V</td> <td>0.025 max / 0.05 max* / 0.10 max*</td> </tr> <tr> <td>16V</td> <td>0.035 max / 0.10 max*</td> </tr> <tr> <td>≤10V</td> <td>0.05 max / 0.10 max*</td> </tr> </tbody> </table> <p><b>3.Characteristic : F (Y5V)</b></p> <table border="1"> <thead> <tr> <th>Rated Voltage</th> <th>Spec</th> </tr> </thead> <tbody> <tr> <td>50V / 35V / 25V</td> <td>0.05 max / 0.07 max* / 0.09 max*</td> </tr> <tr> <td>16V</td> <td>0.07 max / 0.09 max* / 0.125 max*</td> </tr> <tr> <td>10V</td> <td>0.125 max / 0.16 max*</td> </tr> <tr> <td>≤6.3V</td> <td>0.16 max</td> </tr> </tbody> </table> <p>※ The conditions of measurement may be altered upon request.</p>	Rated Voltage	Spec	50V /35V	0.025 max / 0.05 max*	25V	0.025 max / 0.05 max* / 0.10 max*	16V	0.035 max / 0.10 max*	≤10	0.035 max / 0.10 max*	Rated Voltage	Spec	50V≥/ 35V / 25V	0.025 max / 0.05 max* / 0.10 max*	16V	0.035 max / 0.10 max*	≤10V	0.05 max / 0.10 max*	Rated Voltage	Spec	50V / 35V / 25V	0.05 max / 0.07 max* / 0.09 max*	16V	0.07 max / 0.09 max* / 0.125 max*	10V	0.125 max / 0.16 max*	≤6.3V	0.16 max	
Rated Voltage	Spec																														
50V /35V	0.025 max / 0.05 max*																														
25V	0.025 max / 0.05 max* / 0.10 max*																														
16V	0.035 max / 0.10 max*																														
≤10	0.035 max / 0.10 max*																														
Rated Voltage	Spec																														
50V≥/ 35V / 25V	0.025 max / 0.05 max* / 0.10 max*																														
16V	0.035 max / 0.10 max*																														
≤10V	0.05 max / 0.10 max*																														
Rated Voltage	Spec																														
50V / 35V / 25V	0.05 max / 0.07 max* / 0.09 max*																														
16V	0.07 max / 0.09 max* / 0.125 max*																														
10V	0.125 max / 0.16 max*																														
≤6.3V	0.16 max																														

You can check the specification at the web site or contact sales people for each product with mark\*

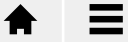

Part Numbering  
Reliability Level Description  
Normal Capacitors\_Standard  
Normal Capacitors\_High Level I  
Normal Capacitors\_High Level II

Land Side Capacitors (LSC)  
High Bending Strength Capacitors  
Low Acoustic Noise Capacitors  
Low ESL Capacitors  
Application Guide

Packaging Specifications  
Caution/Notice  
Disclaimer & Limitation of Use and Applications  
Component Sales Offices/  
Manufacturing Sites

# Reliability Test Conditions

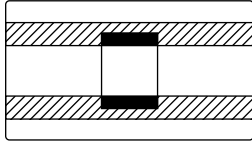
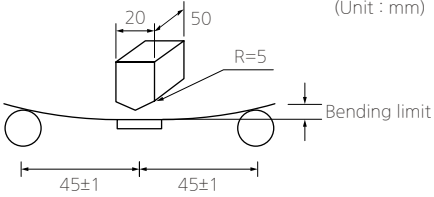
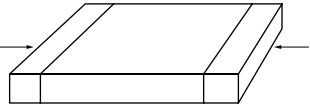
No.	Item	Performance	Test condition																
6	Class I	<table border="1"> <thead> <tr> <th>Characteristic</th> <th>Temp. coefficient(PPM/°C)</th> </tr> </thead> <tbody> <tr> <td>c</td> <td>0 ±30</td> </tr> </tbody> </table>	Characteristic	Temp. coefficient(PPM/°C)	c	0 ±30	apacitance shall be measured by the steps shown in the following table. <table border="1"> <thead> <tr> <th>Step</th> <th>Temperature(°C)</th> </tr> </thead> <tbody> <tr> <td>1</td> <td>25 ± 2</td> </tr> <tr> <td>2</td> <td>Min. operating temp ± 2</td> </tr> <tr> <td>3</td> <td>25 ± 2</td> </tr> <tr> <td>4</td> <td>Max. operating temp ± 2</td> </tr> <tr> <td>5</td> <td>25 ± 2</td> </tr> </tbody> </table> <p><b>(1) Class I</b> Temperature Coefficient shall be calculated from the formula as below</p> $\text{Temp. Coefficient} = \frac{C2-C1}{C1 \times \Delta T} \times 10^6 [\text{ppm}/^\circ\text{C}]$ <p>C1 : Capacitance at 3 C2 : Capacitance at 125°C ΔT : 125°C-25°C=100°C</p> <p><b>(1) Class II</b> Capacitance change shall be calculated from the formula as below</p> $\Delta C = \frac{C2-C1}{C1} \times 100(\%)$ <p>C1 : Capacitance at step 3 C2 : Capacitance at step 2 &amp; step 4</p>	Step	Temperature(°C)	1	25 ± 2	2	Min. operating temp ± 2	3	25 ± 2	4	Max. operating temp ± 2	5	25 ± 2
	Characteristic	Temp. coefficient(PPM/°C)																	
c	0 ±30																		
Step	Temperature(°C)																		
1	25 ± 2																		
2	Min. operating temp ± 2																		
3	25 ± 2																		
4	Max. operating temp ± 2																		
5	25 ± 2																		
Class II	<table border="1"> <thead> <tr> <th>Characteristic</th> <th>Capacitance change(%) without no bias</th> </tr> </thead> <tbody> <tr> <td>A(X5R) / B(X7R)</td> <td>±15%</td> </tr> <tr> <td>X(X6S), Y(X7S)</td> <td>±22%</td> </tr> <tr> <td>Z(X7T)</td> <td>+22% ~ -33%</td> </tr> <tr> <td>F(Y5V)</td> <td>+22% ~ -82%</td> </tr> </tbody> </table>	Characteristic	Capacitance change(%) without no bias	A(X5R) / B(X7R)	±15%	X(X6S), Y(X7S)	±22%	Z(X7T)	+22% ~ -33%	F(Y5V)	+22% ~ -82%								
Characteristic	Capacitance change(%) without no bias																		
A(X5R) / B(X7R)	±15%																		
X(X6S), Y(X7S)	±22%																		
Z(X7T)	+22% ~ -33%																		
F(Y5V)	+22% ~ -82%																		
7	Adhesive strength of termination	No indication of peeling shall occur on the terminal electrode.	Apply 1N~10N pressure for 10+/-1 sec. per respective chip size  <p>0201,0402(mm)1N 0603(mm)2N 1005,1608(mm)5N 2012,3216,3225(mm)10N</p>																
8	Appearance	No mechanical damage shall occur.	Bending Limit: 1mm Test Speed: 1.0mm/sec. Keep the test board at the limit point in 5 sec. Then Measure Capacitance  <p>(Unit : mm)</p>																
	Capacitance	<table border="1"> <thead> <tr> <th>Class I</th> <th>Capacitance change</th> </tr> </thead> <tbody> <tr> <td>Class I</td> <td>Within ±5% or ±0.5pF whichever is larger</td> </tr> <tr> <th>Class II</th> <th>Capacitance change</th> </tr> <tr> <td>A(X5R) B(X7R) X(X6S) Y(X7S) Z(X7T)</td> <td>Within ±10%</td> </tr> </tbody> </table>		Class I	Capacitance change	Class I	Within ±5% or ±0.5pF whichever is larger	Class II	Capacitance change	A(X5R) B(X7R) X(X6S) Y(X7S) Z(X7T)	Within ±10%								
Class I	Capacitance change																		
Class I	Within ±5% or ±0.5pF whichever is larger																		
Class II	Capacitance change																		
A(X5R) B(X7R) X(X6S) Y(X7S) Z(X7T)	Within ±10%																		
9	Solderability	More than 95% of the terminal surface is to be soldered newly, so metal part does not come out or dissolve 	<table border="1"> <tbody> <tr> <td>Solder</td> <td>Sn_Ag3_0.5Cu</td> </tr> <tr> <td>Solder temp.</td> <td>245±5°C</td> </tr> <tr> <td>Flux</td> <td>RMA Type</td> </tr> <tr> <td>Dip time</td> <td>3±0.3sec</td> </tr> <tr> <td>Pre-heating</td> <td>at 80~120°C for 10~30sec.</td> </tr> </tbody> </table>	Solder	Sn_Ag3_0.5Cu	Solder temp.	245±5°C	Flux	RMA Type	Dip time	3±0.3sec	Pre-heating	at 80~120°C for 10~30sec.						
Solder	Sn_Ag3_0.5Cu																		
Solder temp.	245±5°C																		
Flux	RMA Type																		
Dip time	3±0.3sec																		
Pre-heating	at 80~120°C for 10~30sec.																		

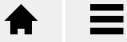

# Reliability Test Conditions

No.	Item	Performance	Test condition																					
10	Resistance to soldering heat	Appearance	No mechanical damage shall occur																					
		Capacitance	<table border="1"> <thead> <tr> <th colspan="2">Capacitance change</th> <th>Capacitance change</th> </tr> </thead> <tbody> <tr> <td colspan="2">Class I</td> <td>±2.5% or ±0.25pF whichever is larger</td> </tr> <tr> <td rowspan="4">Class II</td> <td>A(X5R) B(X7R) X(X6S) Y(X7S) Z(X7T)</td> <td>Within ±7.5%</td> </tr> <tr> <td>F(Y5V)</td> <td>Within ±20%</td> </tr> </tbody> </table>	Capacitance change		Capacitance change	Class I		±2.5% or ±0.25pF whichever is larger	Class II	A(X5R) B(X7R) X(X6S) Y(X7S) Z(X7T)	Within ±7.5%	F(Y5V)	Within ±20%	Solder temperature: 270±5°C/DIP TIME:10±1 sec. Each termination shall be fully immersed and preheated as below: <table border="1"> <thead> <tr> <th>Step</th> <th>Temp.(°C)</th> <th>Time(sec.)</th> </tr> </thead> <tbody> <tr> <td>1</td> <td>80~100</td> <td>60</td> </tr> <tr> <td>2</td> <td>150~180</td> <td>60</td> </tr> </tbody> </table> Leave the capacitor in ambient condition for specified time* before measurement. * 24±2 Hours (Class I) 24±2 Hours (ClassII)	Step	Temp.(°C)	Time(sec.)	1	80~100	60	2	150~180	60
			Capacitance change		Capacitance change																			
			Class I		±2.5% or ±0.25pF whichever is larger																			
		Class II	A(X5R) B(X7R) X(X6S) Y(X7S) Z(X7T)	Within ±7.5%																				
			F(Y5V)	Within ±20%																				
Step	Temp.(°C)		Time(sec.)																					
1	80~100		60																					
2	150~180	60																						
Q(Class I)	Within the specified initial value																							
Tanδ(Class II)	Within the specified initial value																							
Insulation resistance	Within the specified initial value																							
Withstand-ing voltage	No breakdown of dielectric																							
11	Vibration test	Appearance	No mechanical damage shall occur.																					
		Capacitance	<table border="1"> <thead> <tr> <th colspan="2">Capacitance change</th> <th>Capacitance change</th> </tr> </thead> <tbody> <tr> <td colspan="2">Class I</td> <td>±2.5% or ±0.25pF whichever is larger</td> </tr> <tr> <td rowspan="4">Class II</td> <td>A(X5R) B(X7R) X(X6S) Y(X7S) Z(X7T)</td> <td>Within ±5%</td> </tr> <tr> <td>F(Y5V)</td> <td>Within ±20%</td> </tr> </tbody> </table>	Capacitance change		Capacitance change	Class I		±2.5% or ±0.25pF whichever is larger	Class II	A(X5R) B(X7R) X(X6S) Y(X7S) Z(X7T)	Within ±5%	F(Y5V)	Within ±20%	The capacitor shall be subjected to a harmonic motion having a total amplitude of 1.5mm changing frequency from 10Hz to 55Hz and back to 10Hz in about 1 min.  Repeat this for 2hours each in 3mutually perpendicular directions.									
			Capacitance change		Capacitance change																			
			Class I		±2.5% or ±0.25pF whichever is larger																			
		Class II	A(X5R) B(X7R) X(X6S) Y(X7S) Z(X7T)	Within ±5%																				
			F(Y5V)	Within ±20%																				
Q(Class I)	Within the specified initial value																							
Tanδ(Class II)	Within the specified initial value																							
Insulation resistance	Within the specified initial value																							



# Reliability Test Conditions

No.	Item	Performance	Test condition											
12	Appearance	No mechanical damage shall occur	Applied voltage : Rated voltage											
	Capacitance	<table border="1"> <thead> <tr> <th colspan="2">Capacitance change</th> <th>Capacitance change</th> </tr> </thead> <tbody> <tr> <td colspan="2">Class I</td> <td>±7.5% or ±0.75pF whichever is larger</td> </tr> <tr> <td rowspan="4">Class II</td> <td>A(X5R) B(X7R) X(X6S) Y(X7S) Z(X7T)</td> <td>Within ±12.5%</td> </tr> <tr> <td>F(Y5V)</td> <td>±30%</td> </tr> </tbody> </table>	Capacitance change		Capacitance change	Class I		±7.5% or ±0.75pF whichever is larger	Class II	A(X5R) B(X7R) X(X6S) Y(X7S) Z(X7T)	Within ±12.5%	F(Y5V)	±30%	Temperature : 40±2°C Humidity : 90~95%RH Duration time : 500+12/-0Hr. Charge/Discharge current : 50mA max.  Perform the initial measurement according to Note1. Perform the final measurement according to Note2.  This test is only applied to Vr≤500V products. You can check the specification at the web site or contact sales people for each product with mark*
		Capacitance change		Capacitance change										
		Class I		±7.5% or ±0.75pF whichever is larger										
		Class II	A(X5R) B(X7R) X(X6S) Y(X7S) Z(X7T)	Within ±12.5%										
F(Y5V)	±30%													
Q(Class I)	Capacitance ≥30pF: Q≥200 < 30pF: Q≥100+10/3×C (C: Capacitance)													
Moisture resistance	<b>1. Capacitance : A (X5R)</b> 0.05 max / 0.075 max* (35V / 50V) 0.05 max / 0.075 max* / 0.125 max*(16V / 25V) 0.075 max / 0.125 max* (≤10V)  <b>2. Capacitance : B (X7R), X (X6S)</b> 0.05 max / 0.125 max* (16V / 25V / 35V / 50V≥) 0.075 max / 0.125 max* (≤10V)  <b>3. Capacitance : F (Y5V)</b> 0.09 max (50V) 0.09 max / 0.125 max* (25V / 35V) 0.09 max / 0.125 max* / 0.16 max* (16V) 0.16 max / 0.195 max* (10V) 0.195 max (4V / 6.3V)													
Tanδ(Class II)														
Insulation resistance	500MΩ min. or 25MΩ·μF min. product whichever is smaller / 12.5MΩ·μF or over*													



# Reliability Test Conditions

No.	Item	Performance	Test condition															
13	Appearance	No mechanical damage shall occur	Temperature : max. operating temperature															
	Capacitance	<table border="1"> <thead> <tr> <th colspan="2">Capacitance change</th> <th>Capacitance change</th> </tr> </thead> <tbody> <tr> <td colspan="2">Class I</td> <td>±3% or ±0.3pF whichever is larger</td> </tr> <tr> <td rowspan="5">Class II</td> <td>A(X5R)</td> <td rowspan="5">Within ±12.5%</td> </tr> <tr> <td>B(X7R)</td> </tr> <tr> <td>X(X6S)</td> </tr> <tr> <td>Y(X7S)</td> </tr> <tr> <td>Z(X7T)</td> </tr> <tr> <td>F(Y5V)</td> <td>±30%</td> </tr> </tbody> </table>	Capacitance change		Capacitance change	Class I		±3% or ±0.3pF whichever is larger	Class II	A(X5R)	Within ±12.5%	B(X7R)	X(X6S)	Y(X7S)	Z(X7T)	F(Y5V)	±30%	Duration Time: 1000+48/-0 Hr. Charge/Discharge Current: 50mAmax.  Apply Voltage : 100% of Rated Voltage It depends on each item (120%/150%/200% Rated Voltage)  Perform the initial measurement according to Note1 for classII Perform the final measurement according to Note2.  You can check the specification at the web site or contact sales people for each product with mark*
		Capacitance change		Capacitance change														
	Class I		±3% or ±0.3pF whichever is larger															
	Class II	A(X5R)	Within ±12.5%															
B(X7R)																		
X(X6S)																		
Y(X7S)																		
Z(X7T)																		
F(Y5V)	±30%																	
Q(Class I)	Capacitance≥30pF : Q≥350 10pF≤Capacitance<30pF : Q≥275+2.5×C Capacitance < 10pF: Q≥200+10×C (C: Capacitance)																	
Tanδ(Class II)	<b>1. Capacitance :A (X5R)</b> 0.05 max / 0.075 max* (35V / 50V) 0.05 max / 0.075 max* / 0.125 max*(16V / 25V) 0.075 max / 0.125 max* (≤10V)  <b>2. Capacitance : B (X7R), X (X6S)</b> 0.05 max / 0.125 max* (16V / 25V / 35V / 50V≥) 0.075 max / 0.125 max* (≤10V)  <b>3. Capacitance : F (Y5V)</b> 0.09 max (50V) 0.09 max / 0.125 max* (25V / 35V) 0.09 max / 0.125 max* / 0.16 max* (16V) 0.16 max / 0.195 max* (10V) 0.195 max (4V / 6.3V)																	
Insulation resistance	1,000MΩmin. or 50MΩ·μFmin. product whichever is smaller / 25MΩ·μFfor over*																	



# Reliability Test Conditions

No.	Item	Performance	Test condition																
14	Appearance	No mechanical damage shall occur	Capacitor shall be subjected to 5 cycles. Condition for 1 cycle : <table border="1" style="margin-top: 10px;"> <thead> <tr> <th>Step</th> <th>Temp.(°C)</th> <th>Time(min.)</th> </tr> </thead> <tbody> <tr> <td>1</td> <td>Min.rated temp.+0/-3</td> <td>30</td> </tr> <tr> <td>2</td> <td>25</td> <td>2~3</td> </tr> <tr> <td>3</td> <td>Max.rated temp.+3/-0</td> <td>30</td> </tr> <tr> <td>4</td> <td>25</td> <td>2~3</td> </tr> </tbody> </table> Leave the capacitor in ambient condition for specified time before measurement. * 24±2 Hours (Class I) 24±2 Hours (Class II)	Step	Temp.(°C)	Time(min.)	1	Min.rated temp.+0/-3	30	2	25	2~3	3	Max.rated temp.+3/-0	30	4	25	2~3	
	Step	Temp.(°C)		Time(min.)															
	1	Min.rated temp.+0/-3		30															
	2	25		2~3															
	3	Max.rated temp.+3/-0		30															
	4	25		2~3															
	Capacitance	<table border="1" style="width: 100%; text-align: center;"> <thead> <tr> <th colspan="2">Capacitance change</th> <th>Capacitance change</th> </tr> </thead> <tbody> <tr> <td colspan="2">Class I</td> <td>±2.5% or ±0.25pF whichever is larger</td> </tr> <tr> <td rowspan="5">Class II</td> <td>A(X5R)</td> <td>Within ±7.5%/±10%/±15%*</td> </tr> <tr> <td>B(X7R)</td> <td>Within ±7.5%</td> </tr> <tr> <td>X(X6S)</td> <td rowspan="3">Within ±15%</td> </tr> <tr> <td>Y(X7S)</td> </tr> <tr> <td>Z(X7T)</td> </tr> <tr> <td>F(Y5V)</td> <td>Within ±20%</td> </tr> </tbody> </table>		Capacitance change		Capacitance change	Class I		±2.5% or ±0.25pF whichever is larger	Class II	A(X5R)	Within ±7.5%/±10%/±15%*	B(X7R)	Within ±7.5%	X(X6S)	Within ±15%	Y(X7S)	Z(X7T)	F(Y5V)
Capacitance change		Capacitance change																	
Class I		±2.5% or ±0.25pF whichever is larger																	
Class II		A(X5R)	Within ±7.5%/±10%/±15%*																
		B(X7R)	Within ±7.5%																
		X(X6S)	Within ±15%																
	Y(X7S)																		
	Z(X7T)																		
F(Y5V)	Within ±20%																		
Q(Class I)	Within the specified initial value																		
Tanδ(Class II)	Within the specified initial value																		
Insulation resistance	Within the specified initial value																		

Note 1. Initial Measurement For Class II  
 Perform the heat treatment at 150°C +0/-10°C for 1 hour. Then Leave the capacitor in ambient condition for 24±2 hours before measurement  
 Then perform the measurement.

Note 2. Latter Measurement

1. CLASS I  
 Leave the capacitor in ambient condition for 24±2 hours before measurement. Then perform the measurement.
2. CLASS II  
 Perform the heat treatment at 150°C +0/-10°C for 1 hour. Then Leave the capacitor in ambient condition for 24±2 hours before measurement.  
 Then perform the measurement.

Note 3. All Size in Reliability Test Condition Section is "inch"

Note 4. Camera Strobe Circuit Capacitors Should be Following a Special Reliability Test Condition.  
 Please check with our sales representatives or product engineers.

# Packaging Specifications

## Packaging

This specification applies to taping of MLCC.

When customers require, the specification may be changed under the agreement.

### 1 Figure

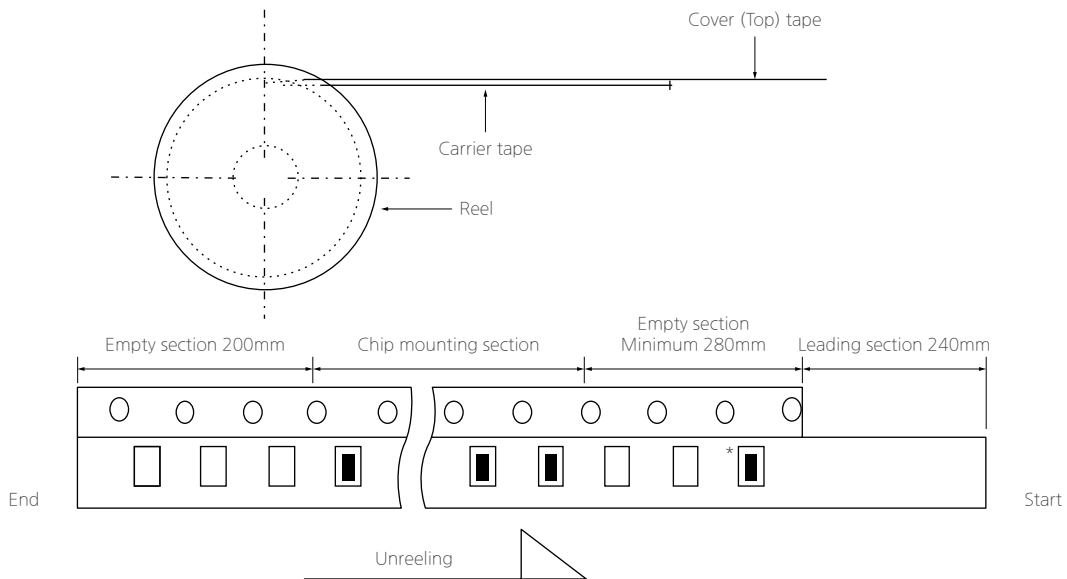

\* The chip is only use for identifying the label and packaged products. Please don't use the chip.

### 2 Quantity

(Unit : pcs)

Type	Size (inch/mm)	Chip Thickness (mm)	Taping Type	Pitch (mm)	Plastic 7 inches reel	Plastic 10 inches reel	Plastic 13 inches reel
MLCC	008004/0201	0.125	EMBOSSSED	1	20K/50K	-	-
	01005/0402	0.2	PAPER	2	20k	-	100K
	0201/0603	0.3	PAPER	2	10K	-	50K
	0402/1005	0.5	PAPER	2	10K	-	50K
	0603/1608	0.8	PAPER	4	4K	10K	15K/10K
		1.0	EMBOSSSED	4	3K	-	-
	0805/2012	T ≤ 0.85	PAPER	4	4K	10K	15K/10K
		T ≥ 1.0	EMBOSSSED	4	2K	6K	10K
	1206/3216	T ≤ 0.85	PAPER	4	4K	10K	10K
		T ≥ 1.0	EMBOSSSED	4	2K	4K	10K
	1210/3225	T ≤ 1.6	EMBOSSSED	4	2K	4K	10K
		T ≥ 2.0	EMBOSSSED	4	1K	4K	4K
	1808/4520	T ≤ 1.6	EMBOSSSED	8	2k	-	8k
		T ≥ 2.0	EMBOSSSED	8	1k	-	4k
	1812/4532	T ≤ 2.0	EMBOSSSED	8	-	-	4K
T > 2.0		EMBOSSSED	8	-	-	2K	
2220/5750	T ≥ 2.5	EMBOSSSED	8	-	-	2K	

# Packaging Specifications

## 3 Tape Size

### I. Cardboard(Paper) tape : 4mm pitch

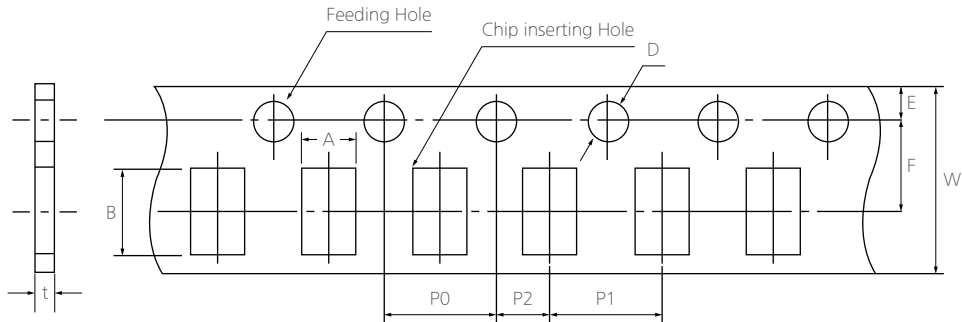

(Unit : mm)

Size (inch/mm)	A	B	W	F	E	P1	P2	P0	D	t
0603/ 1608	1.00 ±0.10	1.90 ±0.10	8.00 ±0.30	3.50 ±0.05	1.75 ±0.10	4.00 ±0.10	2.00 ±0.05	4.00 ±0.10	φ1.50 +0.10/-0	1.1 Below
0805/ 2012	1.55 ±0.10	2.30 ±0.10								
1206/ 3216	2.05 ±0.10	3.60 ±0.10								

※ The A, B in the table above are based on normal dimensions. The data may be changed with the special size tolerances.

### II. Cardboard(Paper) tape (P1 : 1mm/2mm pitch )

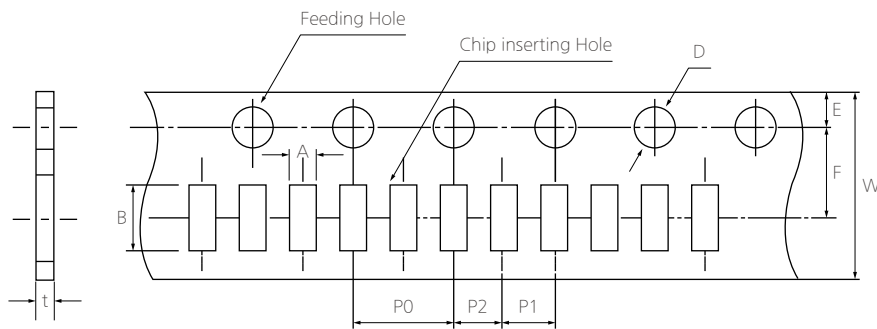

(Unit : mm)

Size (inch/mm)	A	B	W	F	E	P1	P2	P0	D	t
01005/ 0402	0.25 ±0.02	0.46 ±0.02	8.00 ±0.30	3.50 ±0.05	1.75 ±0.10	2.00 ±0.05 (1.0± 0.05)	2.00 ±0.05 (1.0± 0.05)	4.00 ±0.10	φ1.50 +0.1/-0.03	0.25 ±0.02
0201/ 0603	0.38 ±0.03	0.68 ±0.03								0.35 ±0.03
0402/ 1005	0.62 ±0.05	1.12 ±0.05								0.60 ±0.05
0204/ 0510	0.62 /-0.10	1.12 /-0.10								0.37 ±0.03

※ The A, B in the table above are based on normal dimensions. The data may be changed with the special size tolerances.

※ ( ) is based on 1mm pitch paper tape

# Packaging Specifications

## III. Embossed (Plastic) tape

(1) Embossed (Plastic) tape (P1: 4mm pitch )

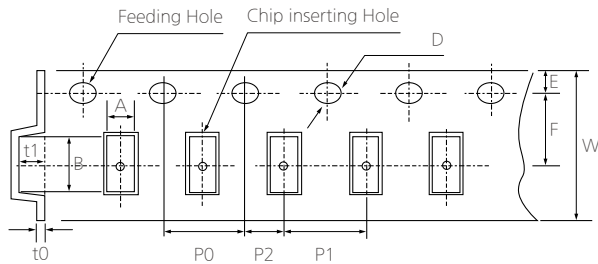

(2) Embossed (Plastic) tape (P1: 1mm/ 2mm pitch )

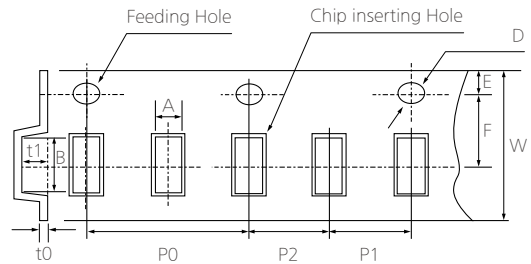

(Unit : mm)

Size (inch/mm)	A	B	W	F	E	P1	P2	P0	D	t1	t0
01005/ 0402	0.23 ±0.02	0.45 ±0.02	4.00 ±0.05	1.80 ±0.02	0.90 ±0.05	1.00 ±0.02	1.00 ±0.02	2.00 ±0.03	φ0.80 ±0.04	0.35 Below	0.50 Below
015008/ 05025	0.32 ±0.03	0.58 ±0.03	8.00 ±0.30	3.50 ±0.05	1.75 ±0.10	2.00 ±0.05	2.00 ±0.05	4.00 ±0.10	φ1.50 0.1/-0.03		
0603/ 1608	1.05 ±0.15	1.90 ±0.15				4.00 ±0.10			2.92 Below		
0805/ 2012	1.45 ±0.20	2.30 ±0.20				8.00 ±0.10				3.80 Below	
1206/ 3216	1.90 ±0.20	3.50 ±0.20									12.0 ±0.30
1210/ 3225	2.80 ±0.20	3.60 ±0.20				2.00 ±0.05			4.00 ±0.10	φ1.50 0.1/-0	
1808/ 4520	2.30 ±0.20	4.90 ±0.20	8.00 ±0.30	3.50 ±0.05	4.00 ±0.10		2.50 Below				
1812/ 4532	3.60 ±0.20	4.90 ±0.20				5.50 ±0.20		6.20 ±0.20			
2220/ 5750	5.50 ±0.20	6.20 ±0.20									
0204/ 0510	0.62 0.05 /-0.10	1.12 0.05 /-0.10	8.00 ±0.30	3.50 ±0.05	4.00 ±0.10	2.50 Below					
0306/ 0816	1.10 ±0.20	1.90 ±0.20									

※ The A, B in the table above are based on normal dimensions. The data may be changed with the special size tolerances.

# Packaging Specifications

## IV. Reel Size

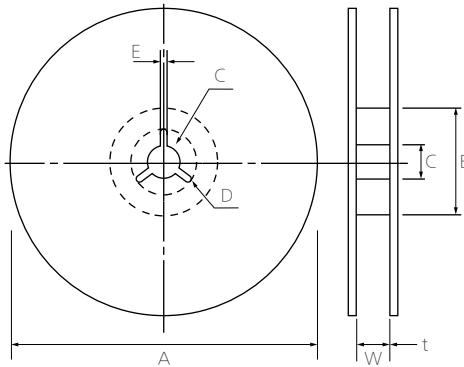

(Unit : mm)

Symbol	Tape Width	A	B	C	D	E	W	t
7"Reel	4mm	φ178±2.0	MINφ50	φ13±0.5	21±0.8	2.0±0.5	5±0.5	1.2±0.2
	8mm	φ178±2.0	MINφ50	φ13±0.5	21±0.8	2.0±0.5	10±1.5	0.9±0.2
	12mm	φ178±2.0	MINφ50	φ13±0.5	21±0.8	2.0±0.5	13±0.5	1.2±0.2
10"Reel	8mm	φ258±2.0	MINφ70	φ13±0.5	21±0.8	2.0±0.5	10±1.5	1.8±0.2
13"Reel	8mm	φ330±2.0	MINφ70	φ13±0.5	21±0.8	2.0±0.5	10±1.5	1.8±0.2
	12mm	φ330±2.0	MINφ70	φ13±0.5	21±0.8	2.0±0.5	13±0.5	2.2±0.2

### 4 Cover tape peel-off force

#### I. Peel-off force

10 g.f ≤ peel-off force ≤ 70 g.f

#### II. Measurement Method

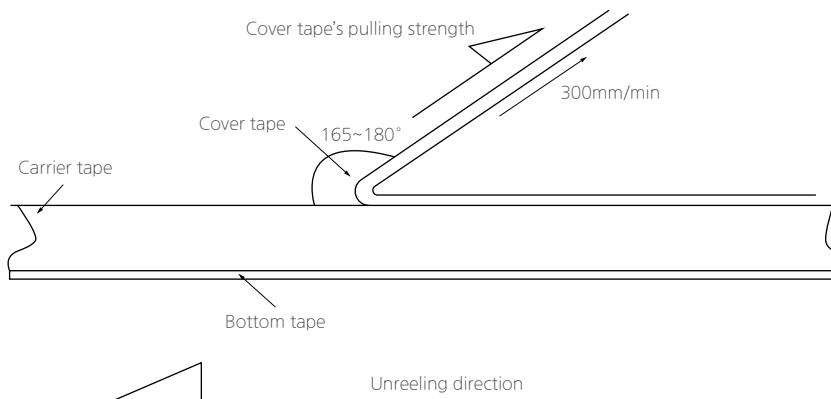

- Taping Packaging design : Packaging design follows IEC 60286-3 standard.  
 (IEC 60286-3 Packaging of components for automatic handling - parts 3)  
 \* If the static electricity of SMT process causes any problems, please contact us.

# Packaging Specifications

## 5 BOX package

### I. Packaging Label

REEL & Box Type

Label includes the information as below.

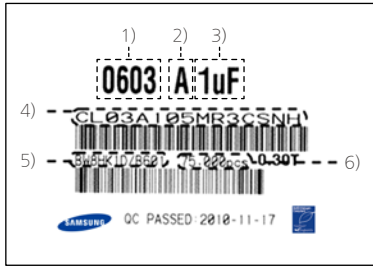

- 1) Chip size
- 2) Temperature Characteristics
- 3) Nominal Capacitance
- 4) Model Name
- 5) LOT Number & Reel Number
- 6) Q'ty

### II. Box Packaging

- 1) Double packaging with the paper type of inner box and outer box.
- 2) Avoid any damages during transportation by car, airplane and ship.
- 3) Remark information of contents on inner box and outer box

※ If special packaging is required, please contact us.

### III. 7" Box packaging

(Unit : mm)

#### ■ Inner Box (7" × 5 REEL )

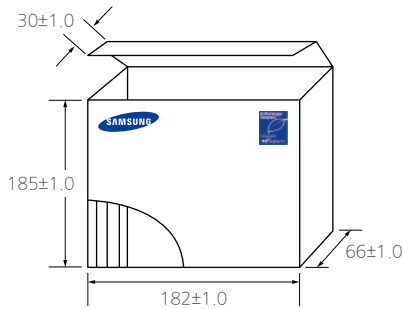

#### ■ Inner Box (7" × 10 REEL )

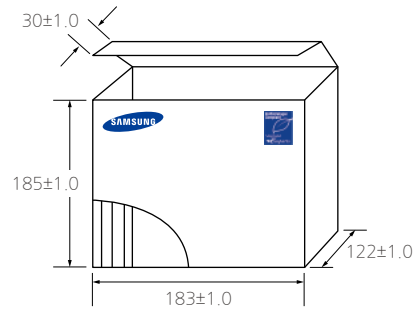

#### ■ Outer Box (7" × 20 REEL)

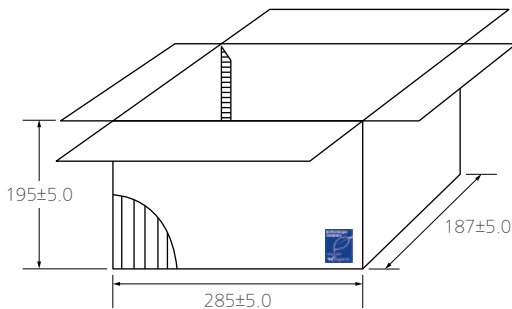

#### ■ Outer Box (7" × 60 REEL)

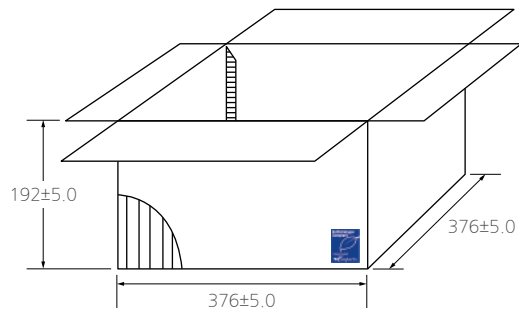

# Packaging Specifications

## IV. 13" Box packaging

■ Inner Box (13" × 4 REEL)

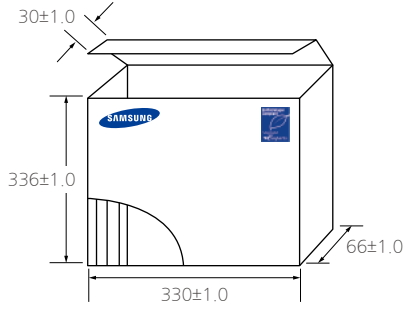

■ Outer Box (13" × 20 REEL)

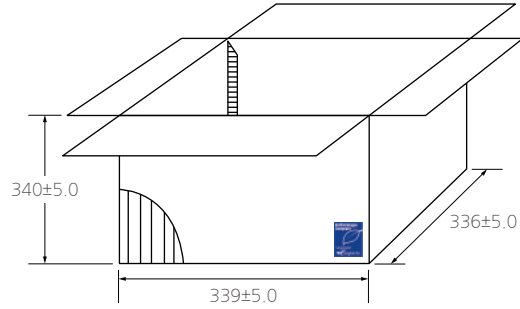

## 6 Chip Weight

Size (L/W) (inch/mm)	Size (T) (mm)	Temp	Weight (mg/pc)
01005/0402	0.2	C0G	0.08
	0.2	X7R	0.09
	0.2	X5R	0.1
0201/0603	0.3	C0G	0.25
	0.3	X7R	0.28
	0.3	X5R	0.32
0402/1005	0.5	C0G	1.2
	0.5	X7R	1.5
	0.5	X5R	1.6
0603/1608	0.8	C0G	4.6
	0.8	X7R	5.8
	0.8	X5R	6.9
0805/2012	0.65	C0G	7.2
	1.25	X7R	18.4
	1.25	X5R	20.9
1206/3216	1.25	C0G	33.9
	1.6	X7R	56.9
	1.6	X5R	58.9
1210/3225	2.5	C0G	77.3
	2.5	X7R	117.7
	2.5	X5R	132.2

※ The weight of product is typical value per size, for more details, please contact us.

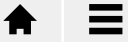

# Caution/Notice

## Product Characteristic data

### 1 Capacitance

The capacitance is the ratio of the change in an electric charge according to voltage change. Due to the fact that the capacitance may be subject to change with the measured voltage and frequency, it is highly recommended to measure the capacitance based on the following conditions.

#### I. Measure capacitance with voltage and frequency specified in this document.

Regarding the voltage/frequency condition for capacitance measurement of each MLCC model, please make sure to follow a section "C. Reliability test Condition - Capacitance" in this document.

The following table shows the voltage and frequency condition according to the capacitance range.  
[The voltage and frequency condition according to MLCC the capacitance range]

#### Class I

Capacitance	Frequency	Voltage
≤1,000pF	1kHz±10%	0.5~5Vrms
>1,000pF	1kHz±10%	

#### Class II

Capacitance	Frequency	Voltage
≤10μF	1kHz±10%	1.0±0.2Vrms
>10μF	120Hz±20%	0.5±0.1Vrms
Exception	1kHz±10%	0.5±0.1Vrms

※ Capacitance shall be measured after the heat treatment of 150+0/-10°C for 1hr, leaving at room temperature for 24±2hr. (Class II)

#### II. It is recommended to use measurement equipment with the ALC (Auto Level Control) option.

The reason is that when capacitance or measurement frequency is high, the output voltage of measurement equipment can be lower than the setting voltage due to the equipment limitation. Note that when capacitance or measurement frequency is excessively high, the measurement equipment may show ALC off warning and provide a lower output voltage than the setting voltage even with ALC option selected. It is necessary to ensure the output voltage of measurement equipment is the same as the setting voltage before measuring capacitance.

#### III. Capacitance value of high dielectric constant (Class II) MLCC changes with applied AC and DC voltage. Therefore, it is necessary to take into account MLCC's AC voltage characteristics and DC-bias voltage characteristics when applying MLCC to the actual circuit.

#### IV. The capacitance is in compliance with the EIA RS-198-1-F-2002.

### 2 Tan δ (DF)

#### I. An ideal MLCC's energy loss is zero, but real MLCC has dielectric loss and resistance loss of electrode. DF (Dissipation Factor) is defined as the ratio of loss energy to stored energy and typically being calculated as percentage.

#### II. Quality factor (Q factor) is defined as the ratio of stored energy to loss energy. The equation can be described as 1/DF. Normally the loss characteristic of Class I MLCC is presented in Q, since the DF value is so small whereas the loss characteristic of Class II MLCC is presented in DF.

#### III. It is recommended to use Class I MLCC for applications to require good linearity and low loss such as coupling circuit, filter circuit and time constant circuit.

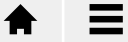

## Caution/Notice

### 3 Insulation Resistance

Ceramic dielectric has a low leakage current with DC voltage due to the high insulating properties. Insulation resistance is defined as the ratio of a leakage current to DC voltage.

- I. When applying DC voltage to MLCC, a charging current and a leakage current flow together at the initial stage of measurement.

While the charging current decreases, and insulation resistance (IR) in MLCC is saturated by time. Therefore, insulation resistance shall be measured 1 minute after applying the rated voltage.

### 4 Capacitance Aging

The aging characteristic is that the high dielectric (Class II) MLCC decreases capacitance value over time. It is also necessary to consider the aging characteristic with voltage and temperature characteristics when Class II MLCC is used in circuitry.

- I. In general, aging causes capacitance to decrease linearly with the log of time as shown in the following graph. Please check with SEMCO for more details, since the value may vary between different models.
- II. After heat treatment (150 °C, 1 hour), the capacitance decreased by aging is recovered, so aging should be considered again from the time of heat treatment.

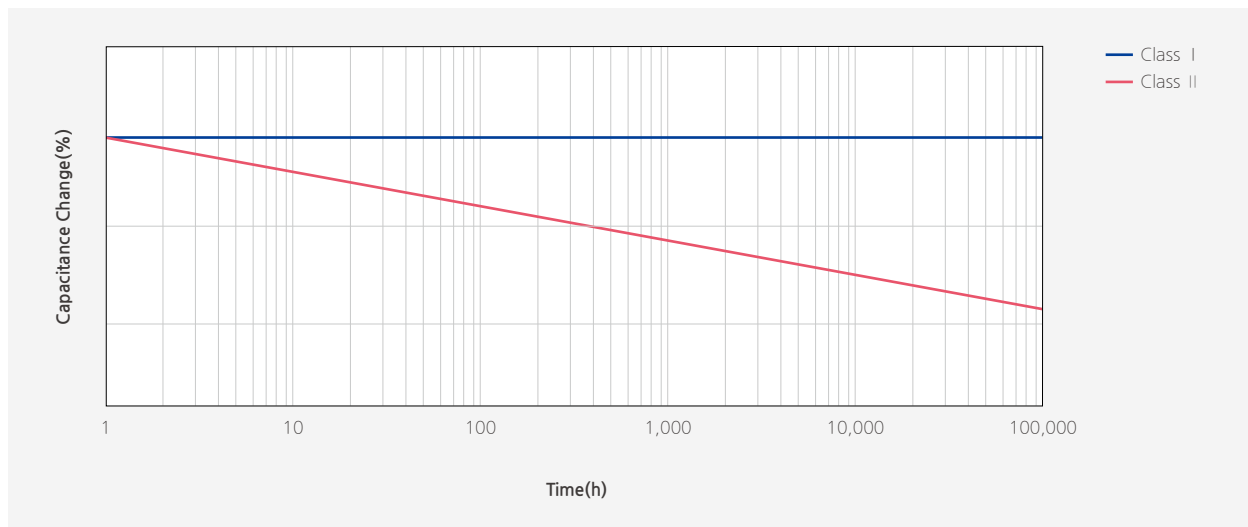

[Example of Capacitance Aging]

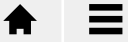

# Caution/Notice

## 5 Temperature Characteristics of Capacitance (TCC)

Please consider temperature characteristics of capacitance since the electrical characteristics such as capacitance changes which is caused by a change in ceramic dielectric constant by temperature.

I. It is necessary to check the values specified in section “C. Reliability test Condition-Temperature Characteristics” for the temperature and capacitance change range of MLCC.

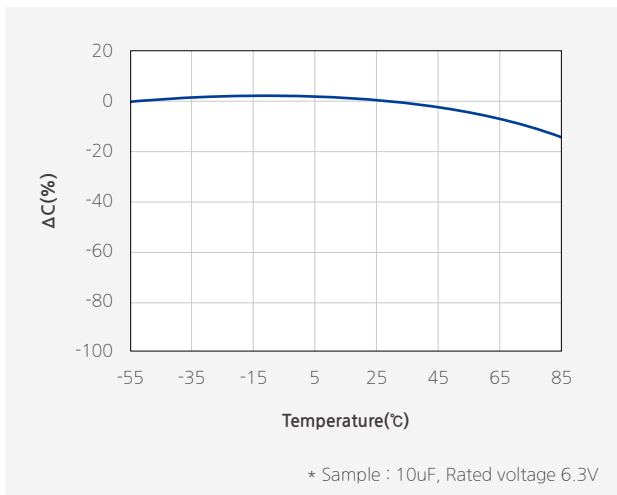

[Example of Temperature Characteristics (X5R)]

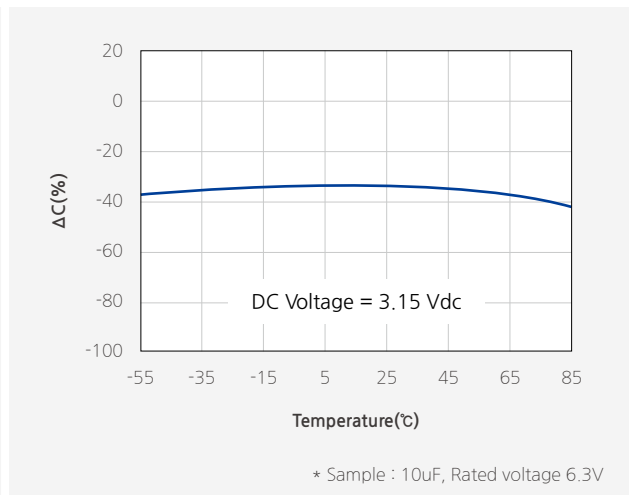

[Example of Bias TCC]

II. When selecting MLCC, it is necessary to consider the heat characteristics of a system, room temperature and TCC of MLCC, since the applied temperature may change the capacitance of MLCC.

III. In addition, Bias TCC of MLCC should be taken into account when DC voltage is applied to MLCC.

## 6 Self-heating Temperature

It is necessary to design the system, with considering self-heating generated by the ESR (Equivalent Series Resistance) of MLCC when AC voltage or pulse voltage is applied to MLCC.

I. When MLCC is used in an AC voltage or pulse voltage circuit, self-heating is generated when AC or pulse current flows through MLCC. Short-circuit may be occurred by the degradation of MLCC’s insulating properties.

II. The reliability of MLCC may be affected by MLCC being used in an AC voltage or pulse voltage circuit, even the AC voltage or the pulse voltage is within the range of rated voltage. Therefore, make sure to check the following conditions.

- 1) The surface temperature of MLCC must stay within the maximum operating temperature after AC or Pulse voltage is applied.
- 2) The rise in increase by self-heating of MLCC must not exceed 20°C

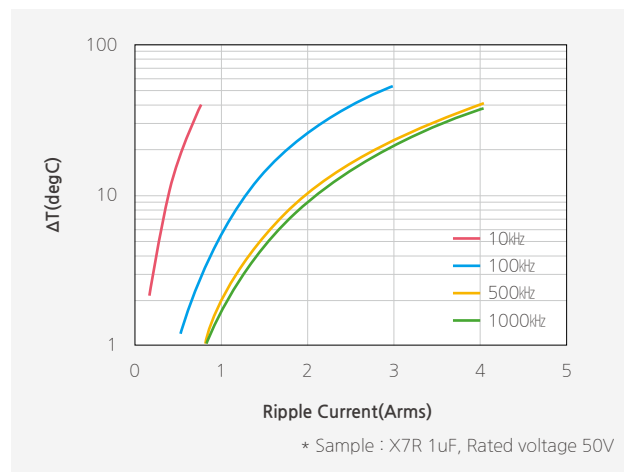

[Example of Ripple current]

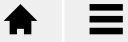

## Caution/Notice

### 7 DC & AC Voltage Characteristics

It is required to consider voltage characteristics in the circuit since the capacitance value of high dielectric constant MLCC (Class II) is changed by applied DC & AC voltage.

- I. Please ensure the capacitance change is within the allowed operating range of a system. In particular, when high dielectric constant type MLCC (Class II) is used in circuit with narrow allowed capacitance tolerance, a system should be designed with considering DC voltage, temperature characteristics and aging characteristics of MLCC.
- II. It is necessary to consider the AC voltage characteristics of MLCC and the AC voltage of a system, since the capacitance value of high dielectric constant type MLCC (Class II) varies with the applied AC voltage.

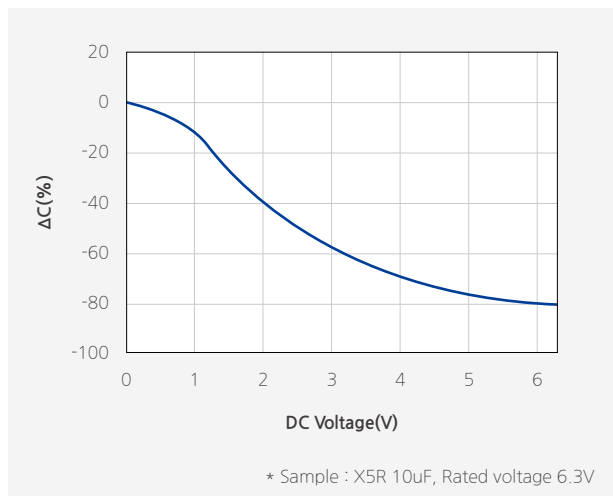

[Example of DC Bias characteristics]

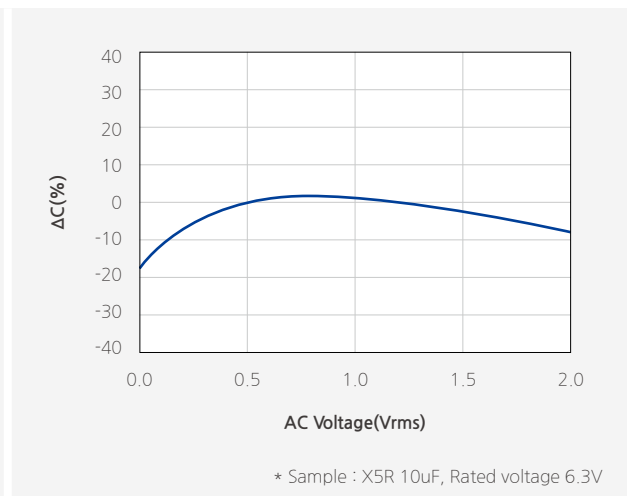

[Example of AC voltage characteristics]

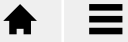

## Caution/Notice

### 8 Impedance Characteristic

Electrical impedance (Z) of MLCC is the measurement of the opposition that MLCC presents to a current (I) when a voltage (V) is applied. It is defined as the ratio of the voltage to the current ( $Z=V/I$ ).

Impedance extends the concept of resistance to AC circuits and is a complex number consisting of the real part of resistance (R) and the imaginary part of reactance (X) as  $Z=R+jX$ .

Therefore, it is required to design circuit with consideration of the impedance characteristics of MLCC based on the frequency ( $Z=R+jX$ ).

**I.** MLCC operates as a capacitor in the low frequency and its reactance (XC) decreases as frequency increases ( $X_C=1/j2\pi fC$ ) where f is frequency and C is capacitance.

The resistance (ESR; Equivalent Series Resistance) of MLCC in the low frequency mainly comes from the loss of its dielectric material.

**II.** MLCC operates as an inductor in the high frequency and the inductance of MLCC is called ESL (Equivalent Series Inductance). The reactance (XL) of MLCC in the high frequency increases as frequency increases ( $X_L=j2\pi f \cdot ESL$ ). The resistance (ESR) of MLCC in the high frequency mainly comes from the loss of its electrode metal.

**III.** SRF (Self Resonant Frequency) of MLCC is the frequency where its capacitive reactance (XC) and inductive reactance (XL) cancel each other and the impedance of MLCC has only ESR at SRF.

**IV.** The impedance of MLCC can be measured by a network analyzer or an impedance analyzer. When using the network analyzer, please note that the small-signal input may lead to the impedance of low capacitance caused by the AC voltage characteristic of MLCC.

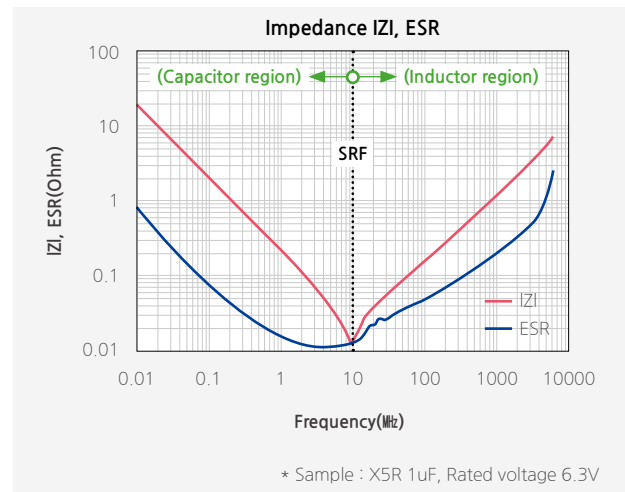

[Example of Impedance characteristics]

# Caution/Notice

## Electrical & Mechanical Caution

### 1 Derating

MLCC with the test voltage at 100% of the rated voltage in the high temperature resistance test are labeled as “derated MLCC.” For this type of MLCC, the voltage and temperature should be derated as shown in the following graph for the equivalent life time of a normal MLCC with the test voltage at 150% of the rated voltage in the high temperature resistance test.

- I. The derated MLCC should be applied with the derating voltage and temperature as shown in the following graph.
- II. The “Temperature of MLCC” in the x-axis of the graph below indicates the surface temperature of MLCC including self-heating effect. The “Voltage Derating Ratio” in the y-axis of the graph below gives the maximum operating voltage of MLCC with reference to the maximum voltage (Vmax) as defined in section “3-2. Applied Voltage.”

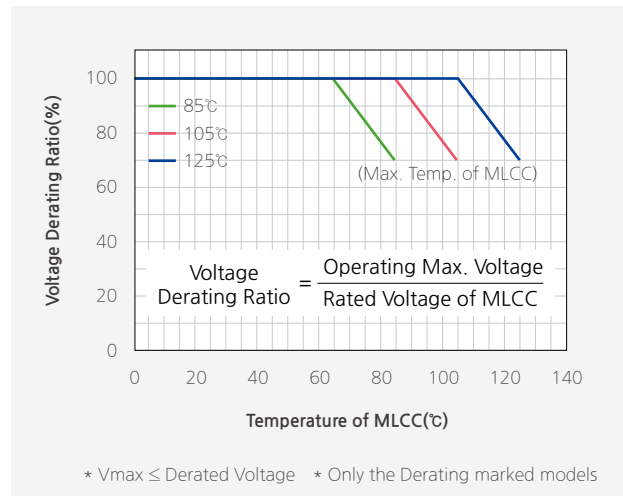

[Example of derating graph for derated MLCC]

### 2 Applied Voltage

The actual applied voltage on MLCC should not exceed the rated voltage set in the specifications.

#### I. Cautions by types of voltage applied to MLCC

- For DC voltage or DC+AC voltage, DC voltage or the maximum value of DC + AC voltage should not exceed the rated voltage of MLCC.
- For AC voltage or pulse voltage, the peak-to-peak value of AC voltage or pulse voltage should not exceed the rated voltage of MLCC.
- Abnormal voltage such as surge voltage, static electricity should not exceed the rated voltage of MLCC.

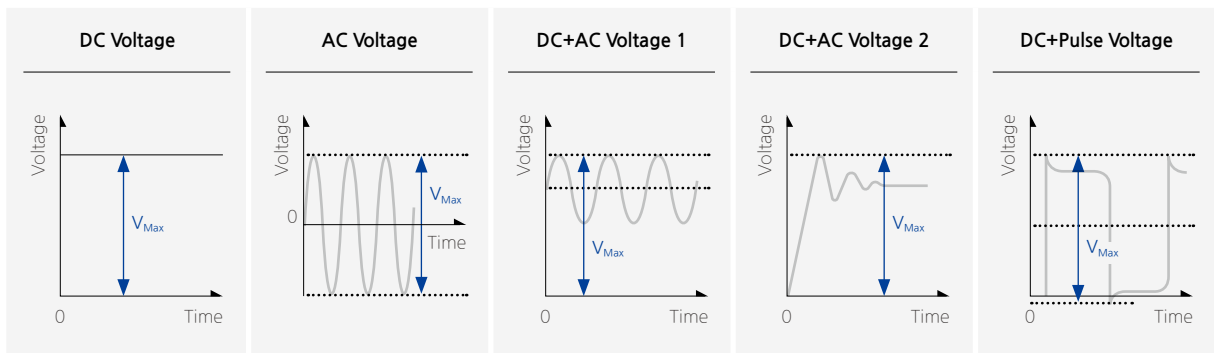

[Types of Voltage Applied to the Capacitor]

# Caution/Notice

## II. Effect of EOS (Electrical Overstress)

- Electrical Overstress such as a surge voltage or EOS can cause damages to MLCC, resulting in the electrical short failure caused by the dielectric breakdown in MLCC.
- Down time of MLCC is varied with the applied voltage and the room temperature and a dielectric shock caused by EOS can accelerate heating on the dielectric. Therefore, it can bring about a failure of MLCC in a market at the early stage.
- Please use caution not to apply excessive electrical overstress including spike voltage MLCC when preparing MLCC for testing or evaluating.

### (1) Surge

When the overcurrent caused by surge is applied to MLCC, the influx of current into MLCC can induce the overshooting phenomenon of voltage as shown in the graph below and result in the electrical short failure in MLCC. Therefore, it is necessary to be careful to prevent the influx of surge current into MLCC.

### (2) ESD (Electrostatic Discharge)

Since the voltage of the static electricity is very high but the quantity of electric charge is small compared to the surge, ESD can cause damage to MLCC with low capacitance as shown in the following graph, whereas surge with lots of electric charge quantity can cause damages to even high capacitance MLCC.

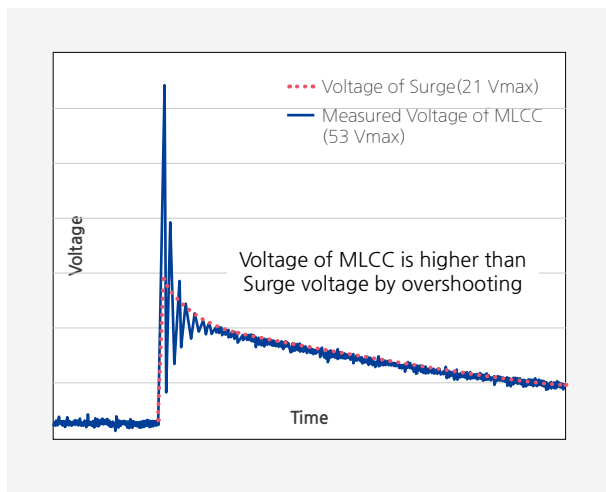

[Example of Surge applied to MLCC]

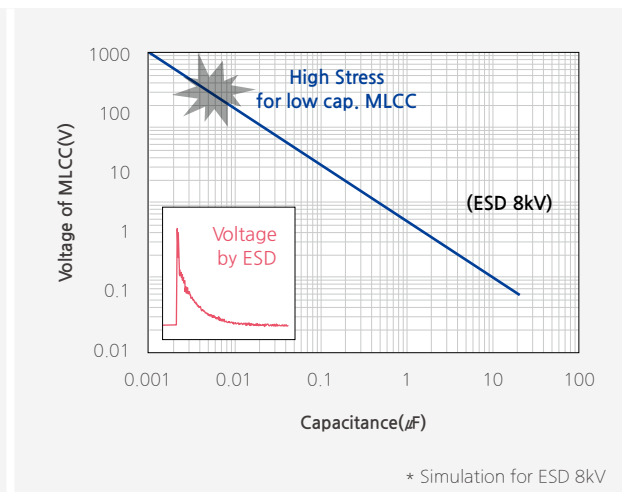

[Example of ESD applied to MLCC]

## 3 Vibration

Please check the types of vibration and shock, and the status of resonance. Manage MLCC not to generate resonance and avoid any kind of impact to terminals. When MLCC is used in a vibration environment, please make sure to contact us for the situation and consider special MLCC such as Soft-term, etc.

## 4 Shock

Mechanical stress caused by a drop may cause damages to a dielectric or a crack in MLCC. Do not use a dropped MLCC to avoid any quality and reliability deterioration. When piling up or handling printed circuit boards, do not hit MLCC with the corners of a PCB to prevent cracks or any other damages to the MLCC.

## 5 Piezo-electric Phenomenon

MLCC may generate a noise due to vibration at specific frequency when using the high dielectric constant MLCC (Class II) at AC or Pulse circuits. MLCC may cause a noise if MLCC is affected by any mechanical vibrations or shocks.

# Caution/Notice

## Process of Mounting and Soldering

### I Mounting

MLCC with the test voltage at 100% of the rated voltage in the high temperature resistance test are labeled as “derated MLCC.” For this type of MLCC, the voltage and temperature should be derated as shown in the following graph for the equivalent life time of a normal MLCC with the test voltage at 150% of the rated voltage in the high temperature resistance test.

#### I. Mounting position

It is recommended to locate the major axis of MLCC in parallel to the direction in which the stress is applied.

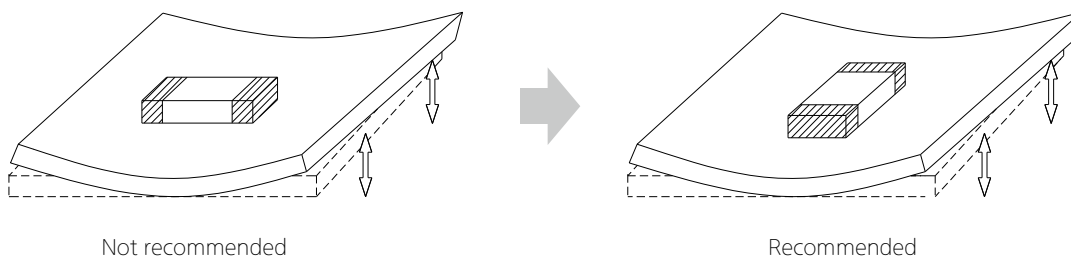

#### II. Cautions during mounting near the cutout

Please take the following measures to effectively reduce the stress generated from the cutting of PCB. Select the mounting location shown below, since the mechanical stress is affected by a location and a direction of MLCC mounted near the cutting line.

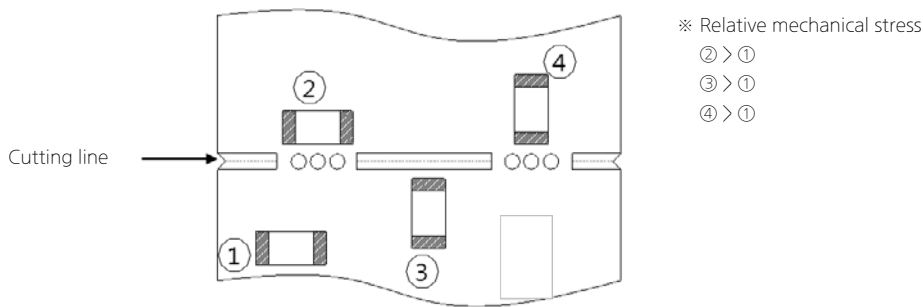

#### III. Cautions during mounting near screw

If MLCC is mounted near a screw hole, the board deflection may be occurred by screw torque. Mount MLCC as far from the screw holes as possible.

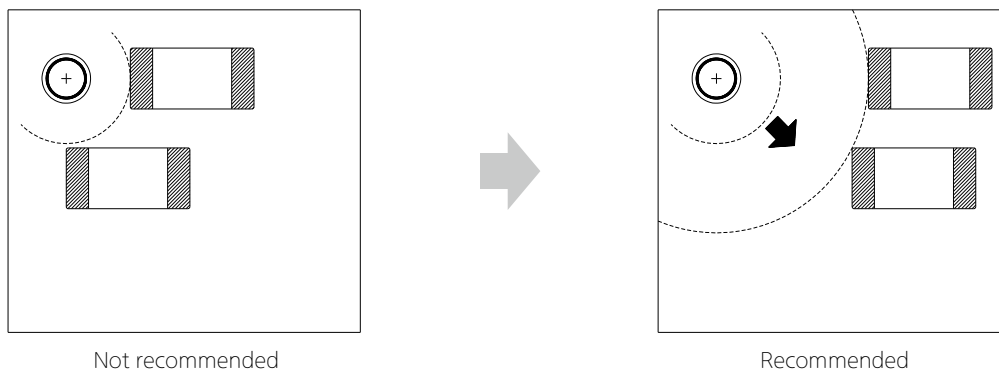

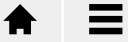

## Caution/Notice

### 2 Caution before Mounting

- I. It is recommended to store and use MLCC in a reel. Do not re-use MLCC that was isolated from the reel.
- II. Check the capacitance characteristics under actual applied voltage.
- III. Check the mechanical stress when actual process and equipment is in use.
- IV. Check the rated capacitance, rated voltage and other electrical characteristics before assembly. Heat treatment must be done prior to measurement of capacitance.
- V. Check the solderability of MLCC that has passed shelf life before use.
- VI. The use of Sn-Zn based solder may deteriorate the reliability of MLCC.

### 3 Cautions during Mounting with Mounting (pick-and-place) Machines

#### I. Mounting Head Pressure

Excessive pressure may cause cracks in MLCC. It is recommended to adjust the nozzle pressure within the maximum value of 300g.f. Additional conditions must be set for both thin film and special purpose MLCC.

#### II. Bending Stress

When using a two-sided substrate, it is required to mount MLCC on one side first before mounting on the other side due to the bending of the substrate caused by the mounting head.

Support the substrate as shown in the picture below when MLCC is mounted on the other side.

If the substrate is not supported, bending of the substrate may cause cracks in MLCC.

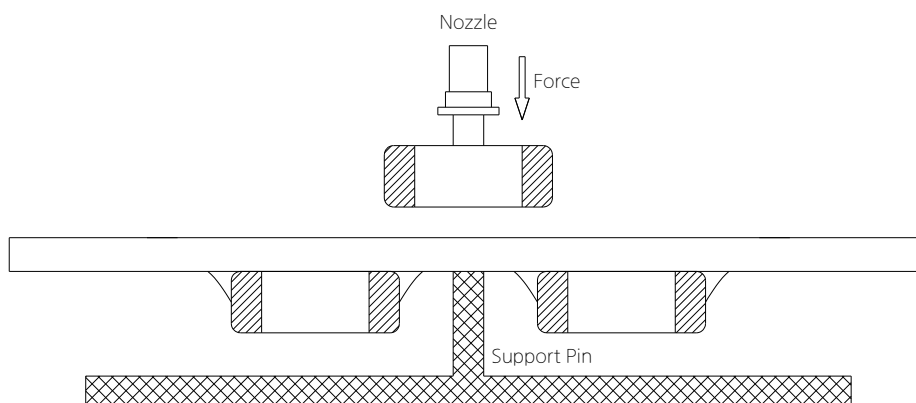

#### III. Suction nozzle

Dust accumulated in a suction nozzle and suction mechanism can impede a smooth movement of the nozzle.

This may cause cracks in MLCC due to the excessive force during mounting.

If the mounting claw is worn out, it may cause cracks in MLCC due to the uneven force during positioning.

A regular inspection such as maintenance, monitor and replacement for the suction nozzle and mounting claw should be conducted.

# Caution/Notice

## 4 Reflow soldering

MLCC is in a direct contact with the dissolved solder during soldering, which may be exposed to potential mechanical stress caused by the sudden temperature change.  
 Therefore, MLCC may be contaminated by the location movement and flux.  
 For the reason, the mounting process must be closely monitored.

Method		Classification
Reflow soldering	Overall heating	Infrared rays
		Hot plate
		VPS(Vapor phase)
	Local heating	Air heater
		Laser
		Light beam

### I . Reflow Profile

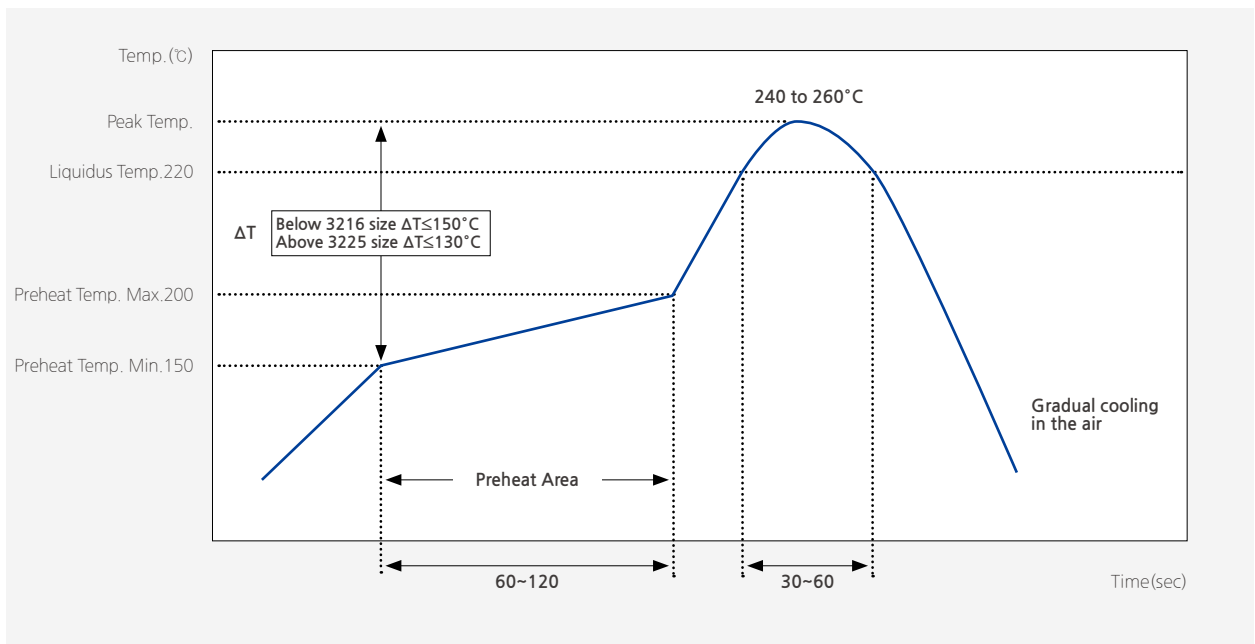

[Reflow Soldering Conditions]

Use caution not to exceed the peak temperature as shown.  
 Pre-heating is necessary for all constituents including the PCB to prevent the mechanical damages on MLCC. The temperature difference between the PCB and the component surface must be kept to the minimum.

As for reflow soldering, it is recommended to keep the number of reflow soldering to less than three times. Please check with us when the number of reflow soldering needs to exceed three times. Care must be exercised especially for the ultra-small size, thin film and high capacitance MLCC as they can be affected by thermal stress more easily.

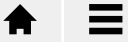

## Caution/Notice

### II. Reflow temperature

The following quality problem may occur when MLCC is mounted with a lower temperature than the reflow temperature recommended by a solder manufacturer. The specified peak temperature must be maintained after taking into consideration the factors such as the placement of peripheral constituent and the reflow temperature.

- Drop in solder wettability
- Solder voids
- Potential occurrence of whisker
- Drop in adhesive strength
- Drop in self-alignment properties
- Potential occurrence of tombstones

### III. Cooling

Natural cooling with air is recommended.

### IV. Optimum solder flux for reflow soldering

- Overly the thick application of solder pastes results in an excessive solder fillet height.
- This makes MLCC more vulnerable to the mechanical and thermal stress from the board, which may cause cracks in MLCC.
- Too little solder paste results in a lack of the adhesive strength, which may cause MLCC to isolate from PCB
- Check if solder has been applied uniformly after soldering is completed.



Too Much Solder  
large stress may cause cracks

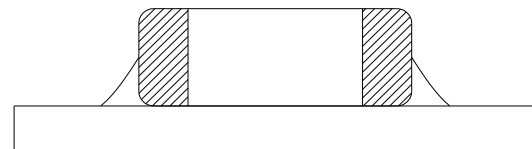

Not enough solder  
Weak holding force may cause bad connections or detaching of the capacitor

- It is required to design a PCB with consideration of a solder land pattern and its size to apply an appropriate amount of solder to MLCC. The amount of the solder at the edge may impact directly on cracks in MLCC.
- The design of a suitable solder land is necessary since the more the solder amount is, the larger the force MLCC experiences and the higher the chance MLCC cracks.

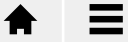

# Caution/Notice

## 5 Flow soldering

### I. Flow profile

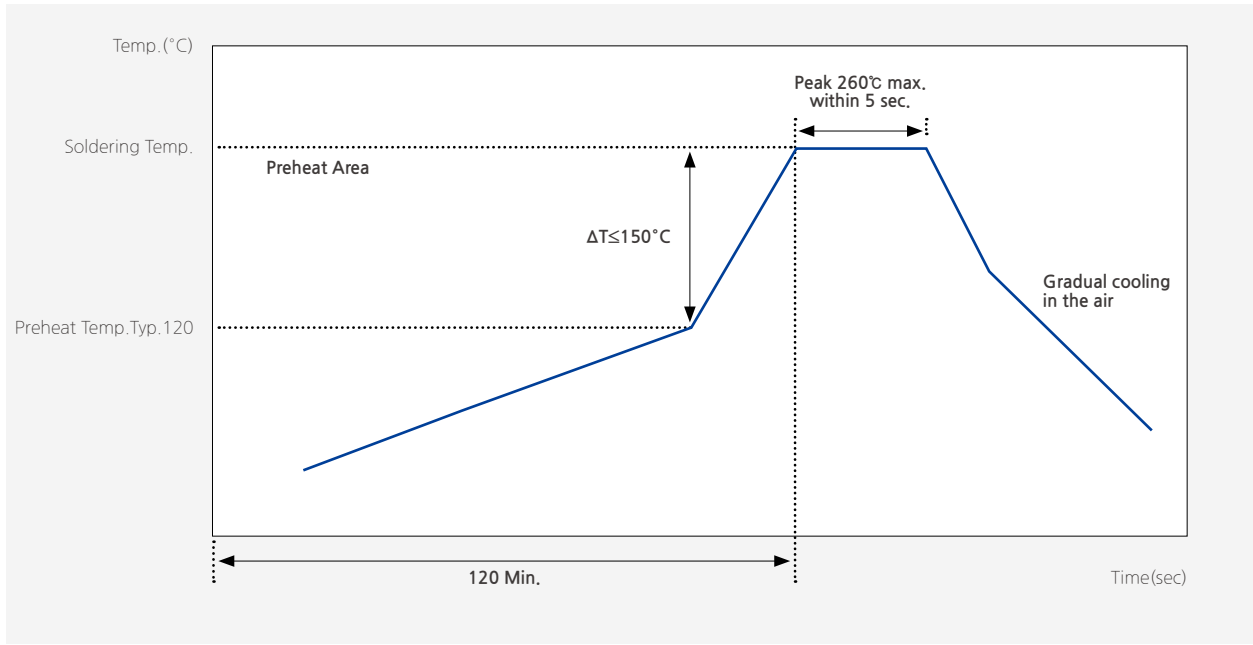

[Flow Soldering Conditions]

Take caution not to exceed peak temperature (260°C) and time (5sec) as shown.

Please contact us before use the type of high capacitance and thin film MLCC for some exceptions that may be caused.

### II. Caution before Flow soldering

- When a sudden heat is applied to MLCC, the mechanical rigidity of MLCC is deteriorated by the internal deformation of MLCC. Preheating all the constituents including PCB is required to prevent the mechanical damages on MLCC. The temperature difference between the solder and the surface of MLCC must be kept to the minimum.
- If the flow time is too long or the flow temperature is too high, the adhesive strength with PCB may be deteriorated by the leaching phenomenon of the outer termination, or the capacitance value may be dropped by weak adhesion between the internal termination and the outer termination.

# Caution/Notice

## 6 Soldering Iron

Manual soldering can pose a great risk on creating thermal cracks in MLCC. The high temperature soldering iron tip may come into a direct contact with the ceramic body of MLCC due to the carelessness of an operator. Therefore, the soldering iron must be handled carefully, and close attention must be paid to the selection of the soldering iron tip and to temperature control of the tip.

### I. How to use a soldering iron

- In order to minimize damages on MLCC, preheating MLCC and PCB is necessary.
- A hot plate and a hot air type preheater should be used for preheating
- Do not cool down MLCC and PCB rapidly after soldering.
- Keep the contact time between the outer termination of MLCC and the soldering iron as short as possible. Long soldering time may cause problems such as adhesion deterioration by the leaching phenomenon of the outer termination.

Case size(Inch)	Variation of Temp.	Soldering Temp.(°C)	Pre-heating Time(sec)	Soldering Time(sec)	Cooling Time(sec)
0201~1206	$\Delta T \leq 190$	350°C max	$\geq 60$	$\leq 3$	-
1210~2220	$\Delta T \leq 130$	280°C max	$\geq 60$	$\leq 3$	-

\* Control  $\Delta T$  in the solder iron and preheating temperature.  
 \* The metal epoxy termination product is rated for a 300°C max.

Condition of Iron facilities		
Wattage	Tip diameter	Soldering time
20W max	3mm max	3sec max

\* Caution - Iron tip should not contact with ceramic body directly  
 Lead-free solder: Sn-3.0Ag-0.5Cu

### II. How to use a spot heater

Compared to local heating using a solder iron, heat by a spot heater heats the overall MLCC and the PCB, which is likely to lessen the thermal shocks. For a high density PCB, a spot heater can prevent the problem to connect between a solder iron and MLCC directly.

- If the distance from the air nozzle outlet to MLCC is too close, MLCC may be cracked due to the thermal stress. Follow the conditions set in the table below to prevent this problem.
- The spot heater application angle as shown in the figure is recommended to create a suitable solder fillet shape.
- In case that heat of higher than 350°C is applied to MLCC containing epoxy material, the epoxy material in MLCC may be damaged by heat.

Distance	$\geq 5\text{mm}$
Hot Air Application angle	45°
Hot Air Temperature Nozzle Outlet	$\leq 400^\circ\text{C}$
Application Time	$\leq 10\text{s}$

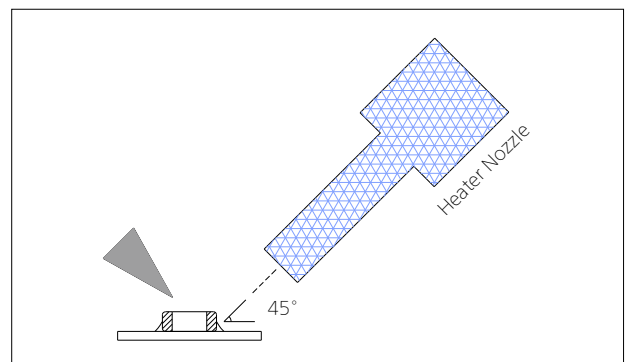

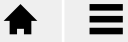

## Caution/Notice

### III. Cautions for re-work

- Too much solder amount will increase the risk of PCB bending or cause other damages.
- Too little solder amount will result in MLCC breaking loose from the PCB due to the inadequate adhesive strength.
- Check if the solder has been applied properly and ensure the solder fillet has a proper shape.

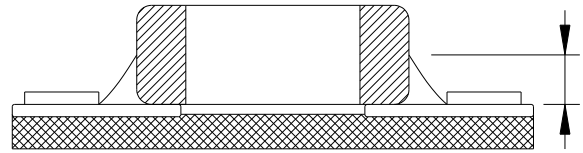

\* Soldering wire below  $\phi 0.5\text{mm}$  is required for soldering.

### 7 Cleaning

#### I. In general, cleaning is unnecessary if rosin flux is used.

When acidic flux is used strongly, chlorine in the flux may dissolve into some types of cleaning fluids, thereby affecting the performance of MLCC.

This means that the cleansing solution must be carefully selected and should always be new.

#### II. Cautions for cleaning

MLCC or solder joint may be cracked with the vibration of PCB, if ultrasonic vibration is too strong during cleaning. When high pressure cleaning equipment is used, test should be done for the cleaning equipment and its process before the cleaning in order to avoid damages on MLCC.

### 8 Cautions for using electrical measuring probes

- Confirm the position of the support pin or jig when checking the electrical performance of MLCC after mounting on the PCB.
- Watch for PCB bending caused by the pressure of a test-probe or other equipment.
- If the PCB is bent by the force from the test probe, MLCC may be cracked or the solder joint may be damaged.
- Avoid PCB flexing by using the support pin on the back side of the PCB.
- Place equipment with the support pin as close to the test-probe as possible.
- Prevent shock vibrations of the board when the test-probe contacts a PCB.

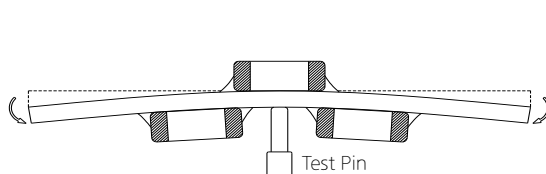

Not recommended

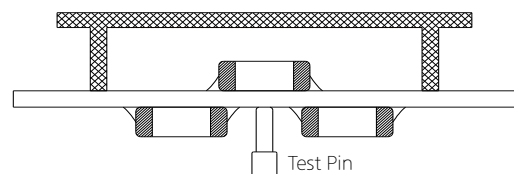

Recommended

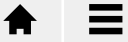

## Caution/Notice

### 9 Printed Circuit Board Cropping

- Do not apply any stress to MLCC such as bending or twisting the board after mounting MLCC on the PCB.
- The stress as shown may cause cracks in MLCC when cutting the board.
- Cracked MLCC may cause degradation to the insulation resistance, thereby causing short circuit.
- Avoid these types of stresses applied to MLCC.

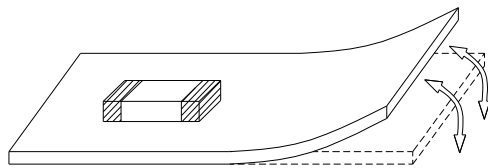

[Bending]

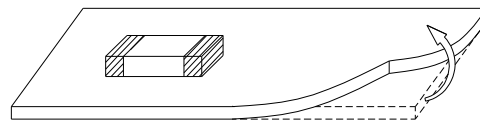

[Twisting]

#### I. Cautions for cutting PCB

Check a cutting method of PCB in advance.

The high density board is separated into many individual boards after the completion of soldering.

If the board is bent or deformed during separation, MLCC may be cracked.

Carefully select a separation method that minimizes the deformation of the PCB.

### 10 Assembly Handling

#### I. Cautions for PCB handling

Hold the edges of the board mounted with MLCC with both hands since holding with one hand may bend the board. Do not use dropped boards, which may degrade the quality of MLCC.

#### II. Mounting other components

Pay attention to the following conditions when mounting other components on the back side of The board after MLCC has been mounted on the front side.

When the suction nozzle is placed too close to the board, board deflection stress may be applied to MLCC on the back side, resulting in cracks in MLCC.

Check if proper value is set on each chip mounter for a suction location, a mounting gap and a suction gap by the thickness of components.

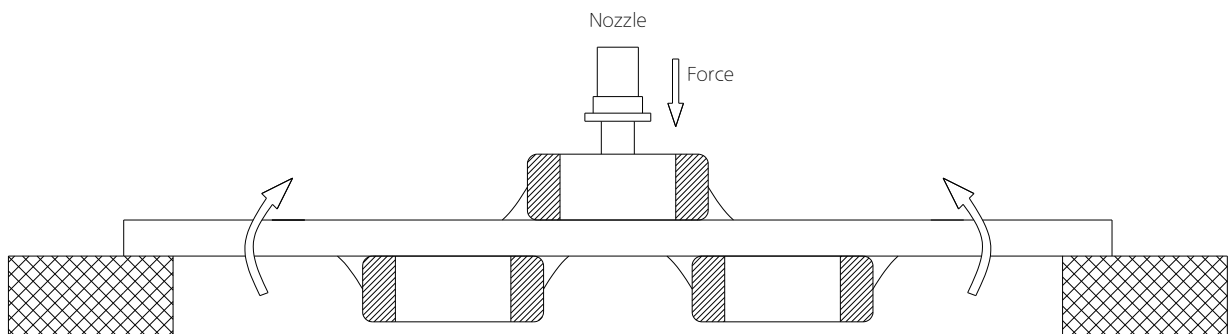

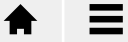

## Caution/Notice

### III. Board mounting components with leads

If the board is bent when inserting components (transformer, IC, etc.) into it, MLCC or solder joint may be cracked. Pay attention to the following:

- Reduce the stress on the board during insertion by increasing the size of the lead insertion hole.
- Insert components with leads into the board after fixing the board with support pins or a dedicated jig.
- Support the bottom side of the board to avoid bending the board.
- Check the status of the height of each support pin regularly when the support pins are used.

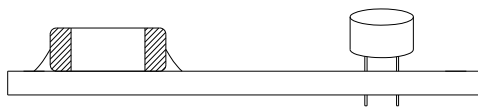

Not recommended

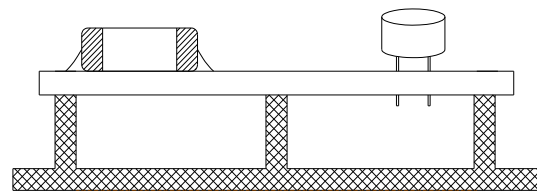

Recommended

### IV. Socket and / or connector attach / detach

Since the insertion or removal from sockets and connectors may cause the board to bend, make sure that MLCC mounted on the board should not be damaged in this process.

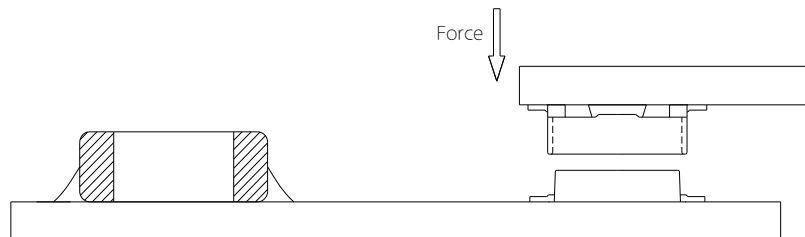

### V. Fastening screw

When attaching a shield on a board, the board may be bent during a screw tightening work.

Pay attention to the following conditions before performing the work.

- Plan the work to prevent the board from bending.
- Use a torque driver to prevent over-tightening of the screw.
- Since the board may be bent by soldering, use caution in tightening the screw.

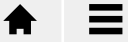

# Caution/Notice

## 11 Adhesive selection

Pay attention to the following if an adhesive is used to position MLCC on the board before soldering.

### I. Requirements for Adhesives

- They must have enough adhesive strength to prevent MLCC from slipping or moving during the handling the board.
- They must maintain their adhesive strength when exposed to soldering temperatures.
- They should not spread when applied to the PCB.
- They should have a long pot life.
- They should hardened quickly.
- They should not corrode the board or MLCC materials.
- They should be an insulator type that does not affect the characteristic of MLCC.
- They should be non-toxic, not harmful, and particularly safe when workers touch the adhesives.

### II. Caution before Applying Adhesive

Check the correct application conditions before attaching MLCC to the board with an adhesive.

If the dimension of land, the type of adhesives, the amount of coating, the contact surface areas, the curing temperature, or other conditions are not appropriate, it may degrade the MLCC performance.

### III. Cautions for selecting Adhesive

Depending on the type of the chosen adhesive, MLCC insulation resistance may be degraded.

In addition, MLCC may be cracked by the difference in contractile stress caused by the different contraction rate between MLCC and the adhesive.

### IV. Cautions for the amount of applied adhesive and curing temperature

- The inappropriate amount of the adhesive cause the weak adhesive strength, resulting in the mounting defect in MLCC.
- Excessive use of the adhesive may cause a soldering defect, loss of electrical connection, incorrect curing, or slippage of a mounting position, thereby an inflow of the adhesive onto the land section should be avoided.
- If the curing temperature is too high or the curing time is too long, the adhesive strength will be degraded. In addition, oxidation both on the outer termination (Sn) of MLCC and the surface of the board may deteriorate the solderability.

## 12 Flux

- I. The excessive amount of flux generates excessive flux gases which may deteriorate solderability. Therefore, apply the flux thin and evenly as a whole.
- II. Flux with a high ratio of halogen may oxidize the outer termination of MLCC, if cleaning is not done properly. Therefore, use flux with a halogen content of 0.1% max.
- III. Strong acidic flux can degrade the MLCC performance.
- IV. Check the solder quality of MLCC and the amount of remaining flux surrounding MLCC after the mounting process.

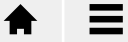

# Caution/Notice

## 13 Coating

### I. Crack caused by Coating

A crack may be caused in the MLCC due to amount of the resin and stress of thermal contraction of the resin during coating process.

During the coating process, the amount of resin and the stress of thermal contraction of the resin may cause cracks in MLCC. The difference of thermal expansion coefficient between the coating, or a molding resin may cause destruction, deterioration of insulation resistance or dielectric breakdown of MLCC such as cracks or detachment, etc.

### II. Recommended Coating material

- A thermal expansion coefficient should be as close to that of MLCC as possible.
- A silicone resin can be used as an under-coating to buffer the stress.
- The resin should have a minimum curing contraction rate.
- The resin should have a minimum sensitivity (ex. Epoxy resin).
- The insulation resistance of MLCC can be deteriorated if a high hygroscopic property resin is used in a high humidity condition.
- Do not use strong acid substances due to the fact that coating materials inducing a family of halogen substances and organic acid may corrode MLCC.

## Design

### 1 Circuit design

When the board is dropped or bent, MLCC mounted on the board may be short-circuited by the drop in insulation resistance. Therefore, it is required to install safety equipment such as a fuse to prevent additional accidents when MLCC is short-circuited, otherwise, electric short and fire may occur. This product is not a safety guaranteed product..

### 2 PCB Design

I. Unlike lead type components, SMD type components that are designed to be mounted directly on the board are fragile to the stress. In addition, they are more sensitive to mechanical and thermal stress than lead type components.

### II. MLCC crack by PCB material type

A great difference of the thermal expansion coefficient between PCB and MLCC causes thermal expansion and contraction, resulting in cracks in MLCC. Even though MLCC is mounted on a board with a fluorine resin or on a single-layered glass epoxy, cracks in MLCC may occur.

### 3 Design system evaluation

I. Evaluate the actual design with MLCC to make sure there is no functional issue or violation of specifications of the finished goods.

II. Please note that the capacitance may differ based on the operating condition of the actual system since Class 2 MLCC capacitance varies with applied voltage and temperature.

III. Surge resistance must be evaluated since the excessive surge caused by the inductance of the actual system may apply to MLCC.

IV. Note the actual MLCC size and the termination shape.

# Caution/Notice

## 4 Land dimension

The recommended land dimension is determined by evaluating the actual SET and a board.

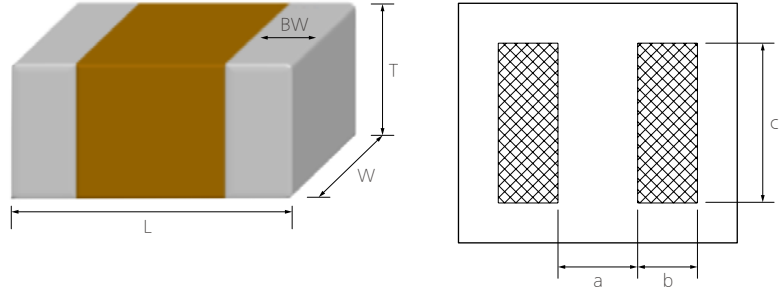

## Reflow Footprint

Chip Size (mm)	Chip Tol. (mm)	a (mm)	b (mm)	c (mm)	(a+2b) min	(a+2b) max	Wmin	Wmax
0201	± 0.013	0.07~0.08	0.09~0.14	0.125~0.135	0.25	0.36	0.125	0.135
	± 0.03	0.07~0.09	0.10~0.15	0.135~0.145	0.27	0.39	0.135	0.145
0402	± 0.02	0.14~0.18	0.19~0.23	0.20~0.24	0.52	0.64	0.20	0.24
	± 0.05	0.15~0.19	0.20~0.24	0.23~0.27	0.55	0.67	0.23	0.27
05025	± 0.025	0.18~0.22	0.24~0.28	0.25~0.29	0.66	0.78	0.25	0.29
0603	± 0.03	0.22~0.28	0.31~0.37	0.30~0.36	0.84	1.02	0.30	0.36
	± 0.05	0.23~0.29	0.32~0.38	0.32~0.38	0.87	1.05	0.32	0.38
	± 0.07	0.24~0.30	0.32~0.38	0.35~0.40	0.88	1.06	0.35	0.40
	± 0.09	0.25~0.31	0.33~0.39	0.36~0.42	0.91	1.09	0.36	0.42
1005	± 0.05	0.36~0.44	0.49~0.57	0.51~0.59	1.34	1.58	0.51	0.59
	± 0.07	0.37~0.45	0.49~0.57	0.53~0.61	1.35	1.59	0.53	0.61
	± 0.10	0.38~0.46	0.50~0.58	0.56~0.64	1.38	1.62	0.56	0.64
	± 0.15	0.40~0.48	0.52~0.60	0.61~0.69	1.44	1.68	0.61	0.69
	± 0.20	0.42~0.50	0.53~0.61	0.66~0.74	1.48	1.72	0.66	0.74
	± 0.25	0.44~0.52	0.55~0.63	0.71~0.79	1.54	1.78	0.71	0.79
	± 0.30	0.45~0.53	0.56~0.64	0.76~0.84	1.57	1.81	0.76	0.84
	± 0.40	0.49~0.57	0.59~0.67	0.86~0.94	1.67	1.91	0.86	0.94
1608	± 0.10	0.63~0.73	0.71~0.81	0.80~0.90	2.05	2.35	0.80	0.90
	± 0.15	0.65~0.75	0.73~0.83	0.90~1.00	2.11	2.41	0.90	1.00
	± 0.20	0.67~0.77	0.74~0.84	0.95~1.05	2.15	2.45	0.95	1.05
	± 0.25	0.69~0.79	0.76~0.86	1.00~1.10	2.21	2.51	1.00	1.10
	± 0.30	0.71~0.81	0.77~0.87	1.05~1.15	2.25	2.55	1.05	1.15
2012	± 0.10	0.79~0.89	0.88~0.98	1.25~1.35	2.55	2.85	1.25	1.35
	± 0.15	0.81~0.91	0.90~1.00	1.30~1.40	2.61	2.91	1.30	1.40
	± 0.20	0.83~0.93	0.91~1.01	1.35~1.45	2.65	2.95	1.35	1.45
	± 0.25	0.85~0.95	0.93~1.03	1.40~1.50	2.71	3.01	1.40	1.50
	± 0.30	0.89~0.97	0.94~1.04	1.45~1.55	2.75	3.05	1.45	1.55
3216	± 0.20	1.64~1.76	1.19~1.31	1.74~1.86	4.02	4.38	1.74	1.86
	± 0.30	1.69~1.81	1.22~1.34	1.84~1.96	4.13	4.49	1.84	1.96
3225	± 0.20	1.64~1.76	1.29~1.41	2.64~2.76	4.22	4.58	2.64	2.76
	± 0.30	1.69~1.81	1.32~1.44	2.74~2.86	4.33	4.69	2.74	2.86
4532	± 0.40	2.17~2.33	1.75~1.91	3.42~3.58	5.67	6.15	3.42	3.58
5750	± 0.40	2.75~2.95	2.03~2.23	5.30~5.50	6.81	7.41	5.30	5.50

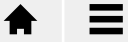

# Caution/Notice

## Flow Footprint

Chip Size (mm)	Chip Tol. (mm)	a (mm)	b (mm)	c (mm)	(a+2b) min	(a+2b) max	Wmin	Wmax
1005	± 0.05	0.55~0.65	0.70~0.80	0.55~0.65	1.95	2.25	0.55	0.65
	± 0.07	0.55~0.65	0.70~0.80	0.55~0.65	1.95	2.25	0.55	0.65
	± 0.10	0.55~0.65	0.70~0.80	0.60~0.70	1.95	2.25	0.60	0.70
	± 0.15	0.55~0.65	0.70~0.80	0.60~0.70	1.95	2.25	0.60	0.70
	± 0.20	0.60~0.70	0.70~0.80	0.65~0.75	2.00	2.30	0.65	0.75
	± 0.25	0.60~0.70	0.70~0.80	0.65~0.75	2.00	2.30	0.65	0.75
1608	± 0.10	0.90~1.00	0.80~0.90	0.90~1.00	2.50	2.80	0.90	1.00
	± 0.15	0.90~1.00	0.85~0.95	0.90~1.00	2.60	2.90	0.90	1.00
	± 0.20	0.90~1.00	0.85~0.95	0.95~1.05	2.60	2.90	0.95	1.05
	± 0.25	0.95~1.05	0.85~0.95	0.95~1.05	2.65	2.95	0.95	1.05
	± 0.30	0.95~1.05	0.85~0.95	1.00~1.10	2.65	2.95	1.00	1.10
2012	± 0.10	1.00~1.10	1.05~1.15	1.30~1.40	3.10	3.40	1.30	1.40
	± 0.15	1.05~1.15	1.05~1.15	1.30~1.40	3.15	3.45	1.30	1.40
	± 0.20	1.05~1.15	1.05~1.15	1.35~1.45	3.15	3.45	1.35	1.45
	± 0.25	1.05~1.15	1.10~1.20	1.35~1.45	3.25	3.55	1.35	1.45
	± 0.30	1.05~1.15	1.10~1.20	1.40~1.50	3.25	3.55	1.40	1.50
	± 0.35	1.05~1.15	1.10~1.20	1.40~1.50	3.25	3.55	1.40	1.50
3216	± 0.15	2.00~2.10	1.40~1.50	1.70~1.80	4.80	5.10	1.70	1.80
	± 0.20	2.00~2.10	1.40~1.50	1.75~1.85	4.80	5.10	1.75	1.85
	± 0.30	2.05~2.15	1.40~1.50	1.80~1.90	4.85	5.15	1.80	1.90
3225	± 0.30	1.90~2.00	1.55~1.65	2.70~2.80	5.00	5.30	2.70	2.80
	± 0.40	1.95~2.05	1.55~1.65	2.75~2.85	5.05	5.35	2.75	2.85

## Others

### I Storage environment

#### I. Recommendation for temperature/humidity

Even taping and packaging materials are designed to endure a long-term storage, they should be stored with a temperature of 0~40°C and an RH of 0~70% otherwise, too high temperatures or humidity may deteriorate the quality of the product rapidly.

As oxidization is accelerated when relative humidity is above 70%RH, the lower the humidity is, the better the solderability is. As the temperature difference may cause dew condensation during the storage of the product, it is a must to maintain a temperature control environment.

#### II. Shelf Life

An allowable storage period should be within 6 months from the outgoing date of delivery in consideration of solderability. As for products in storage over 6 months, please check solderability before use.

### 2 Caution for corrosive environment

As corrosive gases may deteriorate the solderability of MLCC outer termination, it is a must to store MLCC in an environment without gases. MLCC that is exposed to corrosive gases may cause its quality issues due to the corrosion of plating layers and the penetration of moisture.

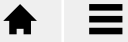

## Caution/Notice

### 3 Equipment in operation

- I. Do not touch MLCC directly with bare hands to prevent an electric shock or damage.
- II. The termination of MLCC shall not be contacted with a conductive object (short -circuit). Do not expose MLCC to conductive liquid containing acidic or alkaline material.
- III. Do not use the equipment in the following conditions.
  - (1) Exposure to water or oil
  - (2) Exposure to direct sunlight
  - (3) Exposure to Ozone or ultra-violet radiation.
  - (4) Exposure to corrosive gas (e.g. hydrogen sulfide, sulfur dioxide, chlorine, ammonia gas)
  - (5) Exposure to vibration or mechanical shock exceeding specified limit
  - (6) Exposure to high humidity
- IV. If the equipment starts generating any smoke, fire or smell, immediately switch it off or unplug from the power source. If the equipment is not switched off or unplugged, serious damage may occur due to the continuous power supply. Please be careful with the high temperature in this condition.

### 4 Waste treatment

In case of scrapping MLCC, it is incinerated or buried by a licensed industrial waste company. When scrapping MLCC, it is recommended to incinerate or bury the scrappage by a licensed industrial waste company.

### 5 Operating temperature

The operating temperature limit is determined by the specification of each models.

- I. Do not use MLCC over the maximum operating temperature.  
Pay attention to equipment's temperature distribution and the seasonal fluctuation of ambient temperature.
- II. The surface temperature of MLCC cannot exceed the maximum operating temperature including self-heating effects.

### 6 Transportation

The performance of MLCC may be affected by transportation conditions.

- I. MLCC shall be protected from excessive temperature, humidity and a mechanical force during transportation.  
During transportation, the cartons shall not be deformed and the inner packaging shall be protected from excessive external forces.
- II. Do not apply excessive vibrations, shocks or excessive forces to MLCC.
  - If excessive mechanical shock or stress are applied, MLCC's ceramic body may crack.
  - When the surface of MLCC is hit with the sharp edge of an air driver, a soldering iron, or a tweezer, etc, MLCC may crack or become short-circuited.
- III. MLCC may crack and become non-functional due to the excessive shocks or dropping during transportation.

### 7 Notice

Some special products are excluded from this document.

Please be advised that this is a standard product specification for a reference only.

We may change, modify or discontinue the product specifications without notice at any time.

So, you need to approve the product specifications before placing an order.

Should you have any question regarding the product specifications, please contact our sales personnel or application engineers.

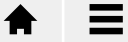

# Disclaimer & Limitation of Use and Applications

## 1 Disclaimer

All product specifications, statements, information and data (collectively, the “Information”) in this spec sheet or made available on the website are subject to change.

The customer is responsible for checking and verifying the extent to which the Information contained in this publication is applicable to an order at the time the order is placed.

All Information given herein is believed to be accurate and reliable, but it is presented without guarantee, warranty, or responsibility of any kind, expressed or implied.

ANY USE OF PRODUCT OUTSIDE OF SPECIFICATIONS OR ANY STORAGE OR INSTALLATION INCONSISTENT WITH PRODUCT GUIDANCE VOIDS ANY WARRANTY.

Accordingly, customer applications which require a high degree of reliability or safety should employ suitable designs or other safeguards (such as installation of protective circuitry or redundancies)

in order to ensure that the failure of an electrical component does not result in a risk of personal injury or property damage.

Although all product-related warnings, cautions and notes must be observed, the customer should not assume that all safety measures are indicted or that other measures may not be required.

## 2 Limitation

Please contact us with usage environment information such as voltage, current, temperature, or other special conditions before using our products for the applications listed below. The below application conditions require especially high reliability products to prevent defects that may directly cause damages or loss to third party's life, body or property.

If you have any questions regarding this 'Limitation', you should first contact our sales personnel or application engineers.

- ① Aerospace/Aviation equipment
- ② 1wheeler, 2wheeler and 3wheeler vehicle
- ③ Automotive of Transportation equipment
- ④ Military equipment
- ⑤ Atomic energy-related equipment
- ⑥ Undersea equipment
- ⑦ Medical equipment
- ⑧ Disaster prevention/crime prevention equipment
- ⑨ Power plant control equipment
- ⑩ Traffic signal equipment
- ⑪ Data-processing equipment
- ⑫ Electric heating apparatus, burning equipment
- ⑬ Safety equipment
- ⑭ Any other applications with the same as or similar complexity or reliability to the applications



Explanation of Ceram. Capacitors  
 Part Numbering  
 Reliability Level Description  
 Normal Capacitors\_Standard  
 Normal Capacitors\_High Level I  
 Normal Capacitors\_High Level II

Micro-Multilayer Capacitors (MLC)  
 Land Side Capacitors (LSC)  
 High Bending Strength Capacitors  
 Low Acoustic Noise Capacitors  
 Low ESL Capacitors  
 Application Guide

Reliability Test Conditions  
 Packaging Specifications  
 Caution/Notice  
 Disclaimer & Limitation of Use and Applications  
 ▶ **Component Sales Offices/  
 Manufacturing Sites**

# Component Sales Offices

## Head Office

150, Maeyeong-ro, Yeongtong-gu, Suwon-si, Gyeonggi-do, Republic of Korea  
**Tel** +82-31-210-5114 (Main Number)

## America

### San Jose

Samsung Electro Mechanics America Inc. (HQ)  
 3655 N 1st street, San Jose CA 95134, U.S.A.  
**Tel** +1-408-544-5454

### San Diego

Samsung Electro Mechanics America Inc. (San Diego office)  
 5405 Morehouse Drive, Suite #220 San Diego CA 92121 USA  
**Tel** +1-858-766-9863

### Phoenix

Samsung Electro Mechanics America Inc. (Phoenix Office)  
 4505 E Chandler Blvd suite #105, Phoenix, AZ, 85048, U.S.A.  
**Tel** +1-480-592-0184

### Detroit

Samsung Electro Mechanics America Inc. (Detroit Office)  
 27777 Franklin Road Suite 1040 Southfield, MI 48034 USA  
**Tel** +1-248-499-8830

### Austin

Samsung Electro Mechanics America Inc. (Austin Office)  
 710 Hesters Crossing Road Suite 180 Round Rock, TX 78681 USA  
**Tel** +1-480-216-4432

## Europe

### Frankfurt

Samsung Electro-Mechanics GmbH. (HQ)  
 Koelner Str. 12, 65760 Eschborn, Germany.  
**Tel** +49-6196-66-3300

### Munich

Samsung Electro-Mechanics GmbH. (Munich Office)  
 Reichenbachstrasse 2, 85737 Ismaning, Germany.  
**Tel** +49-6196-66-7237

### Stuttgart

Samsung Electro-Mechanics GmbH. (Stuttgart Office)  
 Leitzstrasse 45, 70469 Stuttgart, Germany.  
**Tel** +49-7114-906-6281

### Helsinki

Samsung Electro-Mechanics GmbH. (Helsinki Office)  
 Keilaranta 1, 02150 Espoo, Finland.  
**Tel** +35-898-53-1132

## Asia

### Shenzhen

Samsung Electro-Mechanics (ShenZhen) Co.,Ltd.(HQ)  
 14F, Tower A, SCC Building, Junction of Houhai Blvd. and Haide 1st Rd., Nanshan Dist., Shenzhen City, China.  
**Tel** +86-755-8608-5589

### Shanghai

Samsung Electro-Mechanics Co.,Ltd. (Shanghai Branch)  
 13F Room 1301-1302, Tower B, SOHO Zhongshan Building, No.1065 Zhongshan West Rd., Changning Dist., Shanghai City, China.  
**Tel** +86-21-2501-5803

### Beijing

Samsung Electro-Mechanics Co.,Ltd. (Beijing Branch)  
 21F 2101-3, Samsung Tower, Building 1, Yard31, Jinghui Street, Chaoyang Dist, Beijing City, China.  
**Tel** +86-10-5092-8701

### Taipei

Samsung Electro-Mechanics Co.,Ltd. (Taipei Branch)  
 9F-1, No.399 Rueykuang Rd., Neihu Dist., Taipei City, Taiwan.  
**Tel** +886-2-2656-8351

### Singapore

Samsung Electro-Mechanics Private Limited(HQ)  
 3 Church Street Samsung Hub #23-01 Singapore.  
**Tel** +65-6933-2600

### Penang

Samsung Electro-Mechanics Private Limited(Penang Office)  
 Unit 9-06, Menara Boustead, 39 Jalan Sultan Ahmad Shah, 10050, Georgetown, Penang, Malaysia.  
**Tel** +60-12-803-7001

### New Delhi

Samsung Electro-Mechanics Private Limited(New Delhi Office)  
 Unit No. 606, DLF Tower A, District Center Jasola, New Delhi-110025, India  
**Tel** +91-956-005-0310

### Tokyo

Samsung Electro-Mechanics Japan Co., Ltd(HQ)  
 Shinagawa Grand Central Tower 9F, 2-16-4, Kounan, Minato-ku, Tokyo, Japan.  
**Tel** +81-3-6369-6461

# Manufacturing Sites

### Busan Plant

333, Noksansaneopjung-ro, Gangseo-gu,  
 Busan, Republic of Korea  
**Tel** +82-31-210-5114 (Main Number)

### China Tianjin

No.80&96, Xiqiang Road, The west zone of  
 TEDA Tianjin, China 300462  
**Tel** +86-22-6686-3333

### Philippines

BLK 5&6 Calamba Premiere International Park  
 Brgy. Batino Calamba, Laguna Philippines  
**Tel** +63-49-508-8300

\* Suwon (R&D)

**SAMSUNG**  
**ELECTRO-MECHANICS**



## OUR CERTIFICATE

DiGi provide top-quality products and perfect service for customer worldwide through standardization, technological innovation and continuous improvement. DiGi through third-party certification, we stricly control the quality of products and services. Welcome your RFQ to

Email: [Info@DiGi-Electronics.com](mailto:Info@DiGi-Electronics.com)



Tel: +00 852-30501935

RFQ Email: [Info@DiGi-Electronics.com](mailto:Info@DiGi-Electronics.com)

DiGi is a global authorized distributor of electronic components.