

2N3903_D74Z Datasheet

www.digi-electronics.com



<https://www.DiGi-Electronics.com>

DiGi Electronics Part Number	2N3903_D74Z-DG
Manufacturer	onsemi
Manufacturer Product Number	2N3903_D74Z
Description	TRANS NPN 40V 0.2A TO92-3
Detailed Description	Bipolar (BJT) Transistor NPN 40 V 200 mA 625 mW Through Hole TO-92-3



Tel: +00 852-30501935

RFQ Email: Info@DiGi-Electronics.com

DiGi is a global authorized distributor of electronic components.

Purchase and inquiry

Manufacturer Product Number:

2N3903_D74Z

Series:

-

Transistor Type:

NPN

Voltage - Collector Emitter Breakdown (Max):

40 V

Current - Collector Cutoff (Max):

-

Power - Max:

625 mW

Operating Temperature:

-55°C ~ 150°C (TJ)

Package / Case:

TO-226-3, TO-92-3 (TO-226AA) Formed Leads

Base Product Number:

2N3903

Manufacturer:

onsemi

Product Status:

Obsolete

Current - Collector (Ic) (Max):

200 mA

Vce Saturation (Max) @ Ib, Ic:

300mV @ 5mA, 50mA

DC Current Gain (hFE) (Min) @ Ic, Vce:

50 @ 10mA, 1V

Frequency - Transition:

-

Mounting Type:

Through Hole

Supplier Device Package:

TO-92-3

Environmental & Export classification

Moisture Sensitivity Level (MSL):

1 (Unlimited)

ECCN:

EAR99

REACH Status:

REACH Unaffected

HTSUS:

8541.21.0095



2N3903

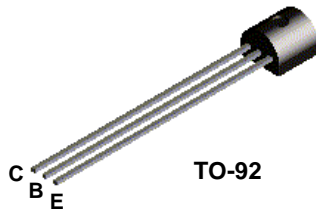

NPN General Purpose Amplifier

This device is designed for use as general purpose amplifiers and switches requiring collector currents to 100 mA.

Absolute Maximum Ratings*

TA = 25°C unless otherwise noted

Symbol	Parameter	Value	Units
V _{CEO}	Collector-Emitter Voltage	40	V
V _{CB0}	Collector-Base Voltage	60	V
V _{EBO}	Emitter-Base Voltage	6.0	V
I _C	Collector Current - Continuous	200	mA
T _J , T _{stg}	Operating and Storage Junction Temperature Range	-55 to +150	°C

*These ratings are limiting values above which the serviceability of any semiconductor device may be impaired.

NOTES:

- 1) These ratings are based on a maximum junction temperature of 150 degrees C.
- 2) These are steady state limits. The factory should be consulted on applications involving pulsed or low duty cycle operations.

Thermal Characteristics

TA = 25°C unless otherwise noted

Symbol	Characteristic	Max	Units
		2N3903	
P _D	Total Device Dissipation Derate above 25°C	625	mW
		5.0	mW/°C
R _{θJC}	Thermal Resistance, Junction to Case	83.3	°C/W
R _{θJA}	Thermal Resistance, Junction to Ambient	200	°C/W

NPN General Purpose Amplifier

(continued)

Electrical Characteristics

TA = 25°C unless otherwise noted

Symbol	Parameter	Test Conditions	Min	Max	Units
--------	-----------	-----------------	-----	-----	-------

OFF CHARACTERISTICS

$V_{(BR)CEO}$	Collector-Emitter Breakdown Voltage*	$I_C = 1.0 \text{ mA}, I_B = 0$	40		V
$V_{(BR)CBO}$	Collector-Base Breakdown Voltage	$I_C = 10 \text{ } \mu\text{A}, I_E = 0$	60		V
$V_{(BR)EBO}$	Emitter-Base Breakdown Voltage	$I_E = 10 \text{ } \mu\text{A}, I_C = 0$	6.0		V
I_{CEX}	Collector Cutoff Current	$V_{CE} = 30 \text{ V}, V_{OB} = 3.0 \text{ V}$		50	nA
I_{BL}	Base Cutoff Current	$V_{CE} = 30 \text{ V}, V_{OB} = 3.0 \text{ V}$		50	nA

ON CHARACTERISTICS*

h_{FE}	DC Current Gain	$V_{CE} = 1.0 \text{ V}, I_C = 0.1 \text{ mA}$ $V_{CE} = 1.0 \text{ V}, I_C = 1.0 \text{ mA}$ $V_{CE} = 1.0 \text{ V}, I_C = 10 \text{ mA}$ $V_{CE} = 1.0 \text{ V}, I_C = 50 \text{ mA}$ $V_{CE} = 1.0 \text{ V}, I_C = 100 \text{ mA}$	20 35 50 30 15	150	
$V_{CE(sat)}$	Collector-Emitter Saturation Voltage	$I_C = 10 \text{ mA}, I_B = 1.0 \text{ mA}$ $I_C = 50 \text{ mA}, I_B = 5.0 \text{ mA}$		0.2 0.3	V V
$V_{BE(sat)}$	Base-Emitter Saturation Voltage	$I_C = 10 \text{ mA}, I_B = 1.0 \text{ mA}$ $I_C = 50 \text{ mA}, I_B = 5.0 \text{ mA}$	0.65	0.85 0.95	V V

SMALL SIGNAL CHARACTERISTICS

C_{ob}	Output Capacitance	$V_{CB} = 5.0 \text{ V}, f = 100 \text{ kHz}$		4.0	pF
C_{ib}	Input Capacitance	$V_{EB} = 0.5 \text{ V}, f = 100 \text{ kHz}$		8.0	pF
h_{re}	Small-Signal Current Gain	$I_C = 10 \text{ mA}, V_{CE} = 20 \text{ V},$ $f = 100 \text{ MHz}$	2.5		
h_{fe}	Small-Signal Current Gain	$V_{CE} = 10 \text{ V}, I_C = 1.0 \text{ mA}$	50	200	
h_{ie}	Input Impedance	$f = 1.0 \text{ kHz}$	1.0	8.0	k Ω
h_{re}	Voltage Feedback Ratio		0.1	5.0	$\times 10^{-4}$
h_{oe}	Output Admittance		1.0	40	μmhos
NF	Noise Figure	$V_{CE} = 5.0 \text{ V}, I_C = 100 \text{ } \mu\text{A},$ $R_S = 1.0 \text{ k}\Omega,$ $B_W = 10 \text{ Hz to } 15.7 \text{ kHz}$		6.0	dB

SWITCHING CHARACTERISTICS

t_d	Delay Time	$V_{CC} = 3.0 \text{ V}, I_C = 10 \text{ mA},$		35	ns
t_r	Rise Time	$I_{B1} = 1.0 \text{ mA}, V_{ob}(\text{off}) = 0.5 \text{ V}$		35	ns
t_s	Storage Time	$V_{CC} = 3.0 \text{ V}, I_C = 10 \text{ mA}$		175	ns
t_f	Fall Time	$I_{B1} = I_{B2} = 1.0 \text{ mA}$		50	ns

*Pulse Test: Pulse Width $\leq 300 \text{ } \mu\text{s}$, Duty Cycle $\leq 2.0\%$

NPN General Purpose Amplifier
(continued)

Typical Characteristics

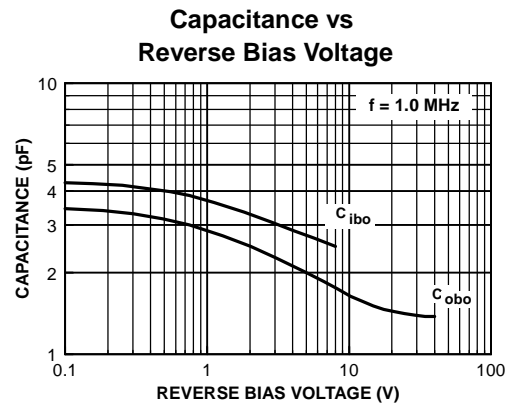
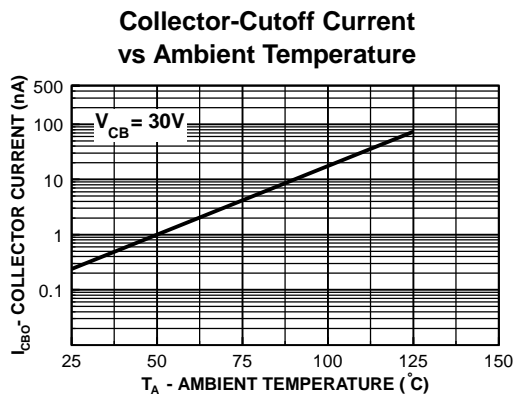
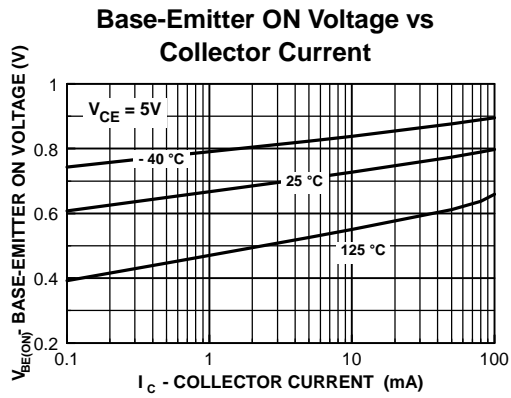
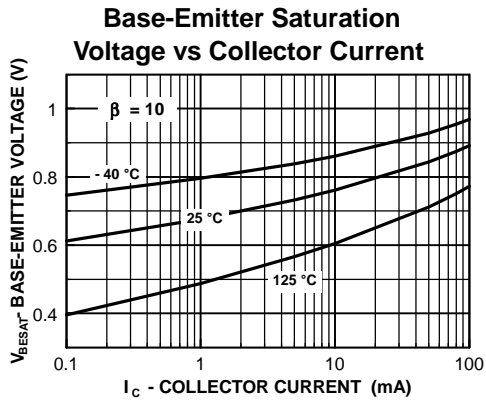
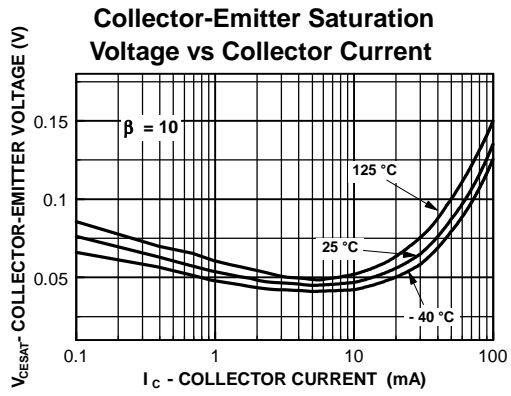
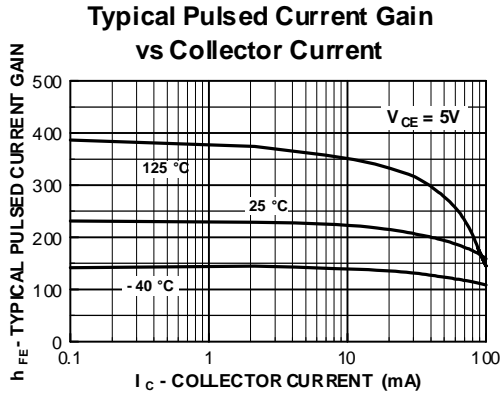

NPN General Purpose Amplifier
(continued)

Typical Characteristics (continued)

Noise Figure vs Frequency

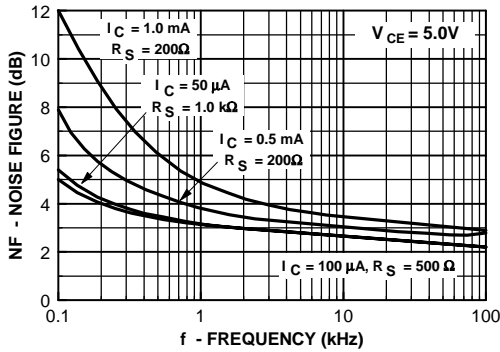

Noise Figure vs Source Resistance

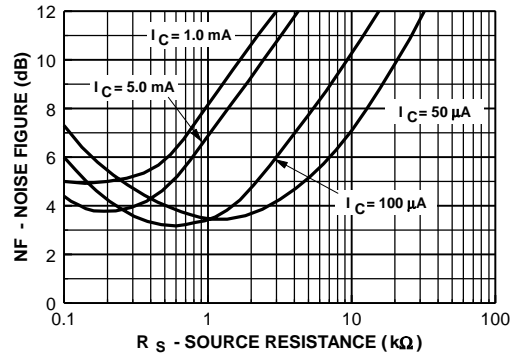

Current Gain and Phase Angle vs Frequency

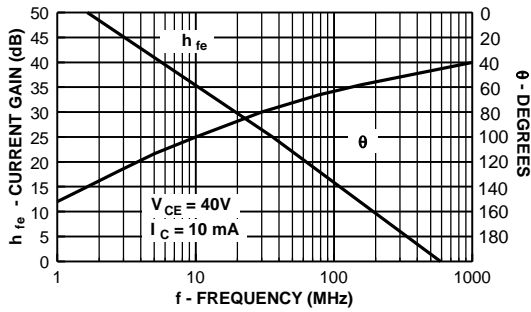

Power Dissipation vs Ambient Temperature

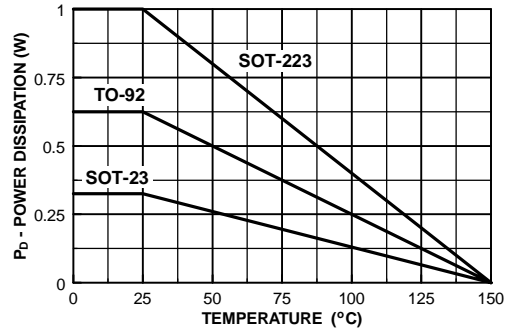

Turn-On Time vs Collector Current

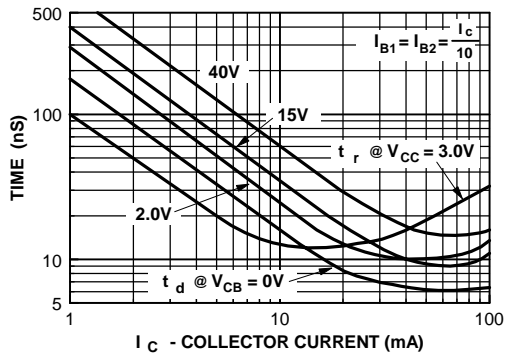

Rise Time vs Collector Current

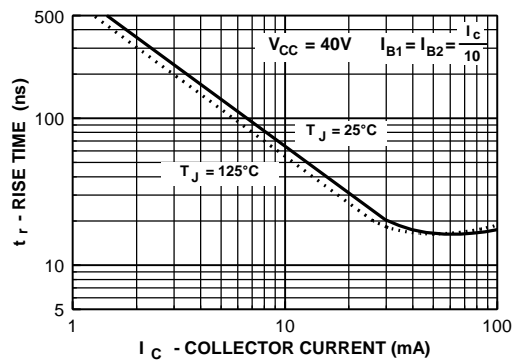

NPN General Purpose Amplifier
(continued)

Typical Characteristics (continued)

Storage Time vs Collector Current

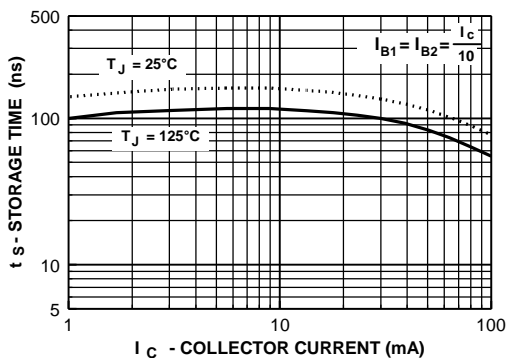

Fall Time vs Collector Current

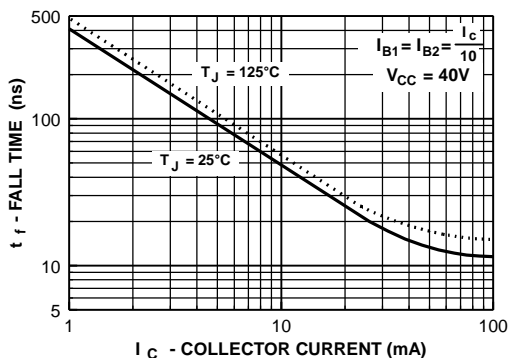

Current Gain

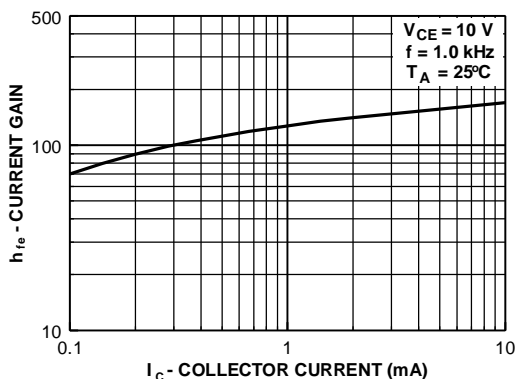

Output Admittance

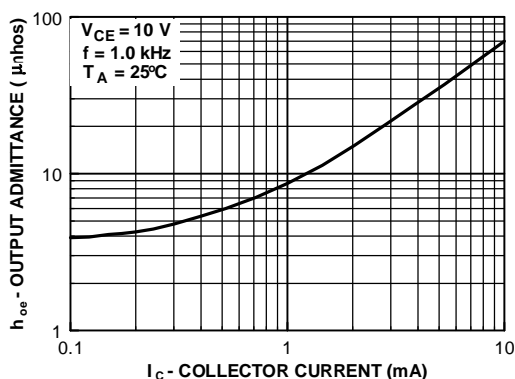

Input Impedance

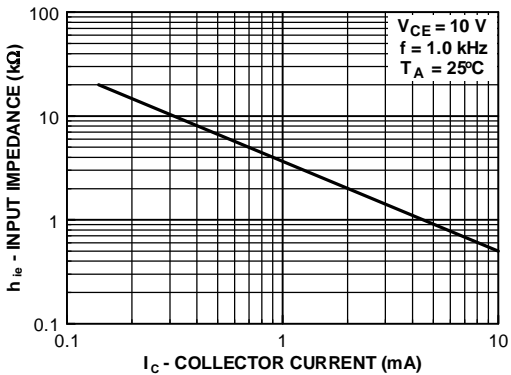

Voltage Feedback Ratio

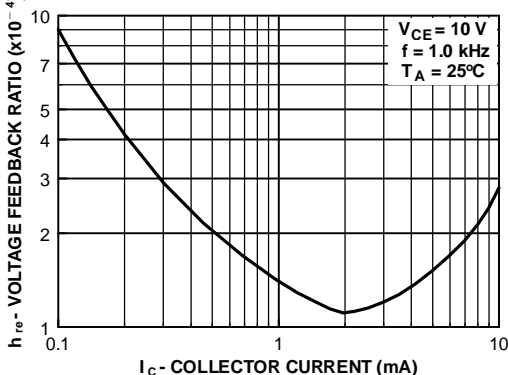

NPN General Purpose Amplifier

(continued)

2N3903

Test Circuits

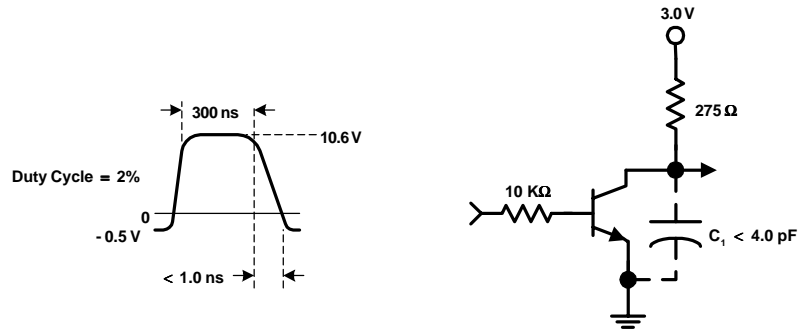

FIGURE 1: Delay and Rise Time Equivalent Test Circuit

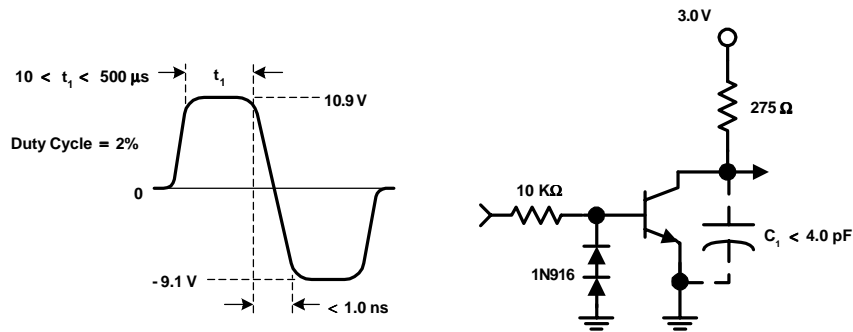

FIGURE 2: Storage and Fall Time Equivalent Test Circuit



TO-92 Tape and Reel Data

TO-92 Packaging Configuration: Figure 1.0

FSCINT Label sample



F63TNR Label sample

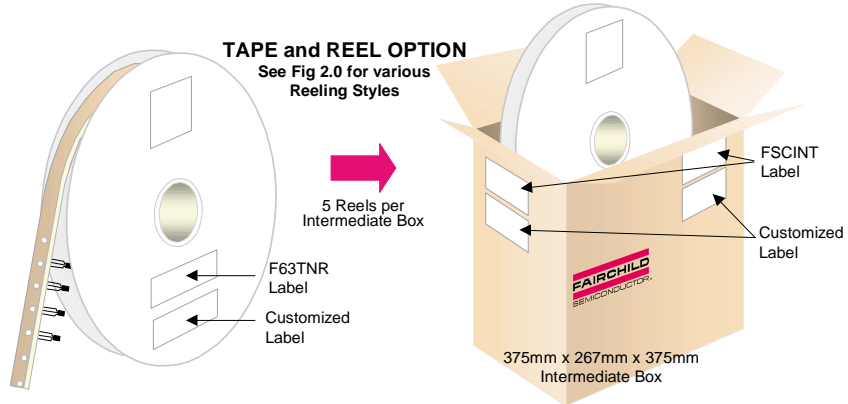

TO-92 TNR/AMMO PACKING INFORMATION

Packing	Style	Quantity	EOL code
Reel	A	2,000	D26Z
	E	2,000	D27Z
Ammo	M	2,000	D74Z
	P	2,000	D75Z

Unit weight = 0.22 gm
 Reel weight with components = 1.04 kg
 Ammo weight with components = 1.02 kg
 Max quantity per intermediate box = 10,000 units

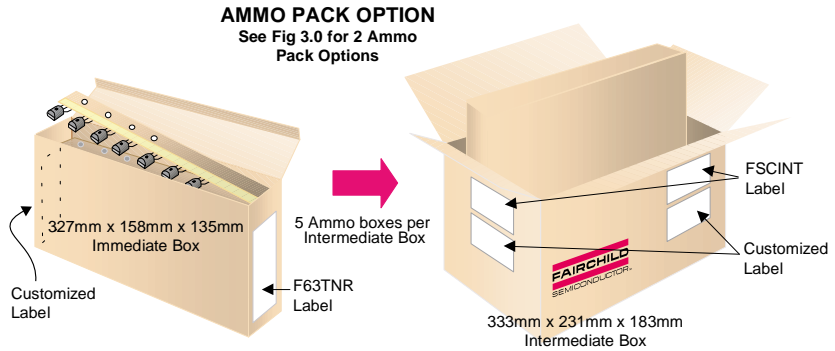

(TO-92) BULK PACKING INFORMATION

EOL CODE	DESCRIPTION	LEADCLIP DIMENSION	QUANTITY
J18Z	TO-18 OPTION STD	NO LEAD CLIP	2.0 K / BOX
J05Z	TO-5 OPTION STD	NO LEAD CLIP	1.5 K / BOX
NO EOL CODE	TO-92 STANDARD STRAIGHT FOR: PKG 92, 94 (NON PROELECTRON SERIES), 96	NO LEADCLIP	2.0 K / BOX
L34Z	TO-92 STANDARD STRAIGHT FOR: PKG 94 (PROELECTRON SERIES BCXXX, BFXXX, BSRXXX), 97, 98	NO LEADCLIP	2.0 K / BOX

BULK OPTION

See Bulk Packing Information table

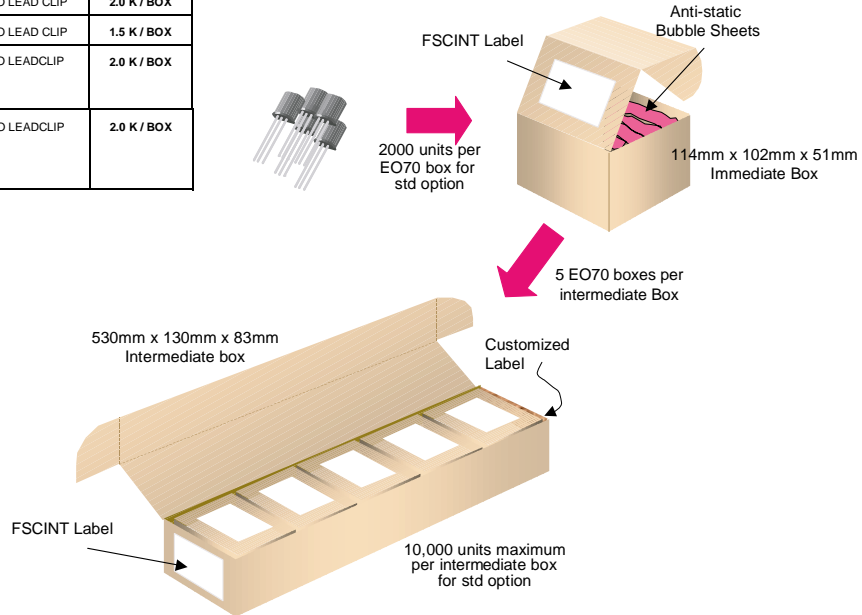

TO-92 Tape and Reel Data, continued

TO-92 Reeling Style

Configuration: Figure 2.0

Machine Option "A" (H)

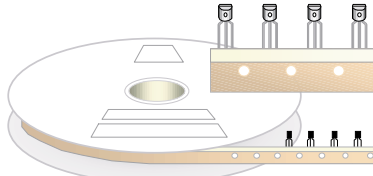

Style "A", D26Z, D70Z (s/h)

Machine Option "E" (J)

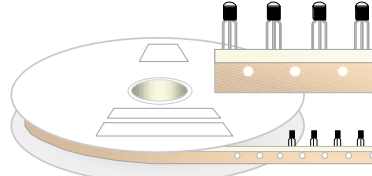

Style "E", D27Z, D71Z (s/h)

TO-92 Radial Ammo Packaging

Configuration: Figure 3.0

FIRST WIRE OFF IS COLLECTOR
ADHESIVE TAPE IS ON THE TOP SIDE
FLAT OF TRANSISTOR IS ON TOP

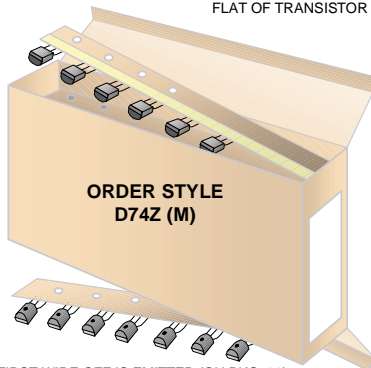

ORDER STYLE
D74Z (M)

FIRST WIRE OFF IS EMITTER (ON PKG. 92)
ADHESIVE TAPE IS ON BOTTOM SIDE
FLAT OF TRANSISTOR IS ON BOTTOM

FIRST WIRE OFF IS EMITTER
ADHESIVE TAPE IS ON THE TOP SIDE
FLAT OF TRANSISTOR IS ON BOTTOM

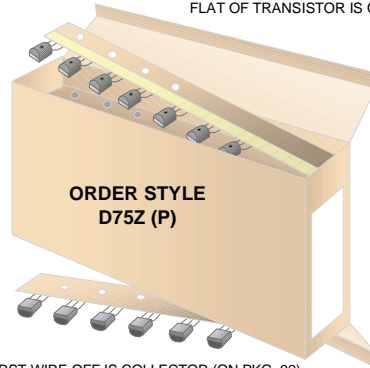

ORDER STYLE
D75Z (P)

FIRST WIRE OFF IS COLLECTOR (ON PKG. 92)
ADHESIVE TAPE IS ON BOTTOM SIDE
FLAT OF TRANSISTOR IS ON TOP

TO-92 Tape and Reel Data, continued

**TO-92 Tape and Reel Taping
Dimension Configuration: Figure 4.0**

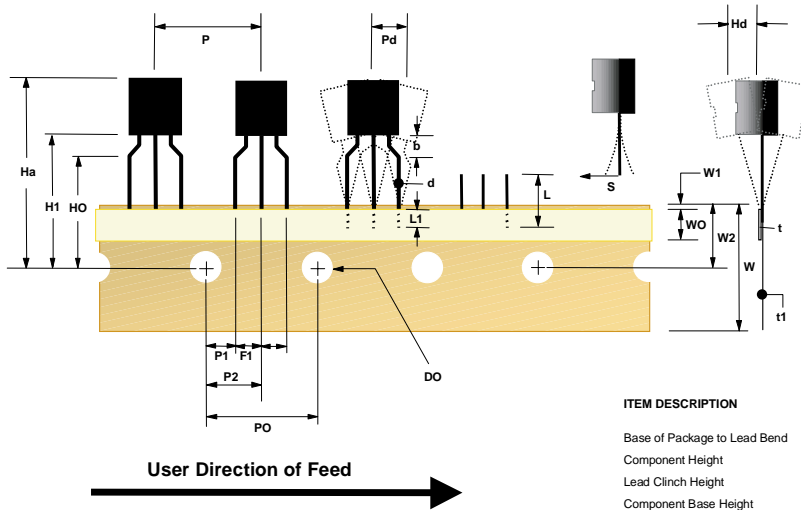

ITEM DESCRIPTION	SYMBOL	DIMENSION
Base of Package to Lead Bend	b	0.098 (max)
Component Height	Ha	0.928 (+/- 0.025)
Lead Clinch Height	HO	0.630 (+/- 0.020)
Component Base Height	H1	0.748 (+/- 0.020)
Component Alignment (side/side)	Pd	0.040 (max)
Component Alignment (front/back)	Hd	0.031 (max)
Component Pitch	P	0.500 (+/- 0.020)
Feed Hole Pitch	PO	0.500 (+/- 0.008)
Hole Center to First Lead	P1	0.150 (+0.009, -0.010)
Hole Center to Component Center	P2	0.247 (+/- 0.007)
Lead Spread	F1/F2	0.104 (+/- 0.010)
Lead Thickness	d	0.018 (+0.002, -0.003)
Cut Lead Length	L	0.429 (max)
Taped Lead Length	L1	0.209 (+0.051, -0.052)
Taped Lead Thickness	t	0.032 (+/- 0.006)
Carrier Tape Thickness	t1	0.021 (+/- 0.006)
Carrier Tape Width	W	0.708 (+0.020, -0.019)
Hold - down Tape Width	WO	0.236 (+/- 0.012)
Hold - down Tape position	W1	0.035 (max)
Feed Hole Position	W2	0.360 (+/- 0.025)
Sprocket Hole Diameter	DO	0.157 (+0.008, -0.007)
Lead Spring Out	S	0.004 (max)

Note : All dimensions are in inches.

**TO-92 Reel
Configuration: Figure 5.0**

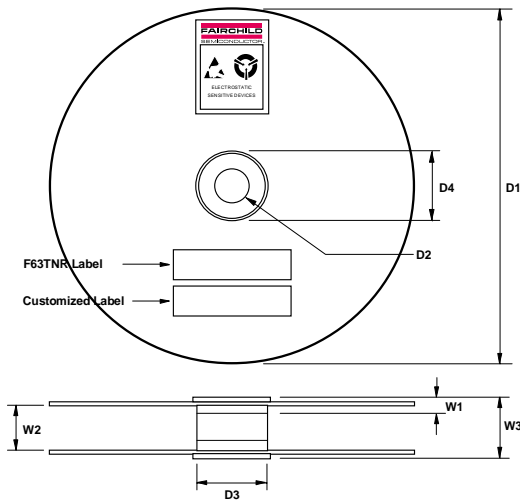

ITEM DESCRIPTION	SYMBOL	MINIMUM	MAXIMUM
Reel Diameter	D1	13.975	14.025
Arbor Hole Diameter (Standard)	D2	1.160	1.200
(Small Hole)	D2	0.650	0.700
Core Diameter	D3	3.100	3.300
Hub Recess Inner Diameter	D4	2.700	3.100
Hub Recess Depth	W1	0.370	0.570
Flange to Flange Inner Width	W2	1.630	1.690
Hub to Hub Center Width	W3		2.090

Note: All dimensions are in inches

TO-92 Package Dimensions



TO-92 (FS PKG Code 92, 94, 96)

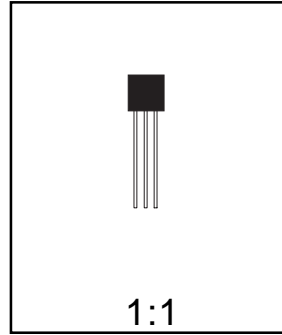
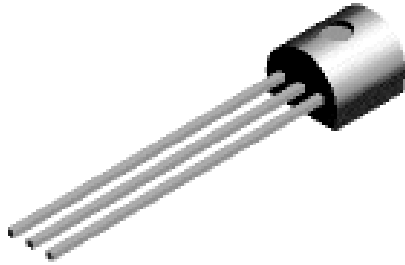

Scale 1:1 on letter size paper

Dimensions shown below are in:
inches [millimeters]

Part Weight per unit (gram): 0.1977

TO-92 (92,94,96)

PIN	92		94		96	
	B	F	B	F	B	F
1	E	D	E	D	B	S
2	B	S	C	G	E	D
3	C	G	B	S	C	G

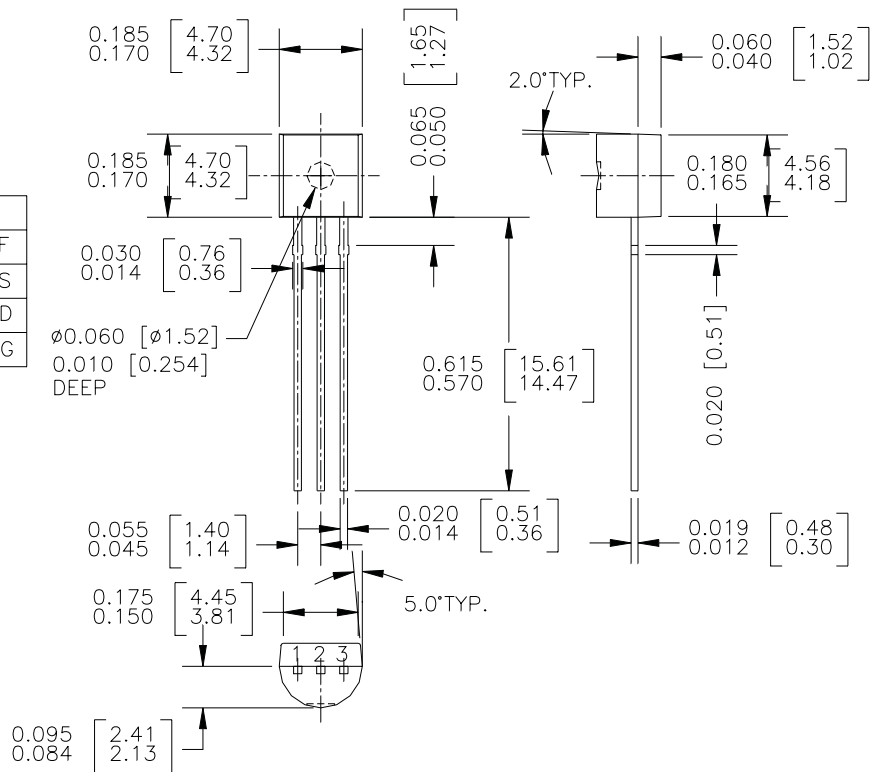

TRADEMARKS

The following are registered and unregistered trademarks Fairchild Semiconductor owns or is authorized to use and is not intended to be an exhaustive list of all such trademarks.

ACE ^x TM	FAST ^r TM	PowerTrench [®]	SyncFET TM
Bottomless TM	GlobalOptoisolator TM	QFET TM	TinyLogic TM
CoolFET TM	GTO TM	QS TM	UHC TM
CROSSVOLT TM	HiSeC TM	QT Optoelectronics TM	VCX TM
DOME TM	ISOPLANAR TM	Quiet Series TM	
E ² CMOS TM	MICROWIRE TM	SILENT SWITCHER [®]	
EnSigna TM	OPTOLOGIC TM	SMART START TM	
FACT TM	OPTOPLANAR TM	SuperSOT TM -3	
FACT Quiet Series TM	PACMAN TM	SuperSOT TM -6	
FAST [®]	POP TM	SuperSOT TM -8	

DISCLAIMER

FAIRCHILD SEMICONDUCTOR RESERVES THE RIGHT TO MAKE CHANGES WITHOUT FURTHER NOTICE TO ANY PRODUCTS HEREIN TO IMPROVE RELIABILITY, FUNCTION OR DESIGN. FAIRCHILD DOES NOT ASSUME ANY LIABILITY ARISING OUT OF THE APPLICATION OR USE OF ANY PRODUCT OR CIRCUIT DESCRIBED HEREIN; NEITHER DOES IT CONVEY ANY LICENSE UNDER ITS PATENT RIGHTS, NOR THE RIGHTS OF OTHERS.

LIFE SUPPORT POLICY

FAIRCHILD'S PRODUCTS ARE NOT AUTHORIZED FOR USE AS CRITICAL COMPONENTS IN LIFE SUPPORT DEVICES OR SYSTEMS WITHOUT THE EXPRESS WRITTEN APPROVAL OF FAIRCHILD SEMICONDUCTOR CORPORATION. As used herein:

1. Life support devices or systems are devices or systems which, (a) are intended for surgical implant into the body, or (b) support or sustain life, or (c) whose failure to perform when properly used in accordance with instructions for use provided in the labeling, can be reasonably expected to result in significant injury to the user.
2. A critical component is any component of a life support device or system whose failure to perform can be reasonably expected to cause the failure of the life support device or system, or to affect its safety or effectiveness.

PRODUCT STATUS DEFINITIONS**Definition of Terms**

Datasheet Identification	Product Status	Definition
Advance Information	Formative or In Design	This datasheet contains the design specifications for product development. Specifications may change in any manner without notice.
Preliminary	First Production	This datasheet contains preliminary data, and supplementary data will be published at a later date. Fairchild Semiconductor reserves the right to make changes at any time without notice in order to improve design.
No Identification Needed	Full Production	This datasheet contains final specifications. Fairchild Semiconductor reserves the right to make changes at any time without notice in order to improve design.
Obsolete	Not In Production	This datasheet contains specifications on a product that has been discontinued by Fairchild semiconductor. The datasheet is printed for reference information only.

OUR CERTIFICATE

DiGi provide top-quality products and perfect service for customer worldwide through standardization, technological innovation and continuous improvement. DiGi through third-party certification, we strictly control the quality of products and services. Welcome your RFQ to

Email: Info@DiGi-Electronics.com



Tel: +00 852-30501935

RFQ Email: Info@DiGi-Electronics.com

DiGi is a global authorized distributor of electronic components.