

2SA2202-TD-E Datasheet

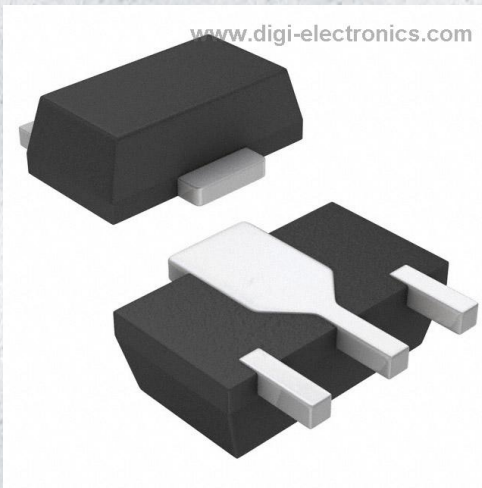

<https://www.DiGi-Electronics.com>

DiGi Electronics Part Number	2SA2202-TD-E-DG
Manufacturer	onsemi
Manufacturer Product Number	2SA2202-TD-E
Description	TRANS PNP 100V 2A PCP
Detailed Description	Bipolar (BJT) Transistor PNP 100 V 2 A 300MHz 3.5 W Surface Mount PCP



Tel: +00 852-30501935

RFQ Email: Info@DiGi-Electronics.com

DiGi is a global authorized distributor of electronic components.

Purchase and inquiry

Manufacturer Product Number:

2SA2202-TD-E

Series:

-

Transistor Type:

PNP

Voltage - Collector Emitter Breakdown (Max):

100 V

Current - Collector Cutoff (Max):

1 μ A (ICBO)

Power - Max:

3.5 W

Operating Temperature:

150°C (TJ)

Package / Case:

TO-243AA

Base Product Number:

2SA2202

Manufacturer:

onsemi

Product Status:

Active

Current - Collector (Ic) (Max):

2 A

Vce Saturation (Max) @ Ib, Ic:

240mV @ 100mA, 1A

DC Current Gain (hFE) (Min) @ Ic, Vce:

200 @ 100mA, 5V

Frequency - Transition:

300MHz

Mounting Type:

Surface Mount

Supplier Device Package:

PCP

Environmental & Export classification

RoHS Status:

ROHS3 Compliant

REACH Status:

REACH Unaffected

HTSUS:

8541.29.0075

Moisture Sensitivity Level (MSL):

1 (Unlimited)

ECCN:

EAR99

Ordering number : ENA0583A



2SA2202

Bipolar Transistor -100V, -2A, Low VCE(sat) PNP Single PCP

ON Semiconductor®

<http://onsemi.com>

Applications

- DC / DC converters, relay drivers, lamp drivers, motor drivers, flash

Features

- Adoption of FBET, MBIT processes
- Low collector to emitter saturation voltage
- High allowable power dissipation
- Large current capacity
- High-speed switching

Specifications

Absolute Maximum Ratings at Ta=25°C

Parameter	Symbol	Conditions	Ratings	Unit
Collector to Base Voltage	V _{CB0}		-100	V
Collector to Emitter Voltage	V _{CES}		-100	V
	V _{CEO}		-100	V
Emitter to Base Voltage	V _{EBO}		-7	V
Collector Current	I _C		-2	A
Collector Current (Pulse)	I _{CP}		-3	A

Continued on next page.

Stresses exceeding Maximum Ratings may damage the device. Maximum Ratings are stress ratings only. Functional operation above the Recommended Operating Conditions is not implied. Extended exposure to stresses above the Recommended Operating Conditions may affect device reliability.

Package Dimensions

unit : mm (typ)

7007B-004

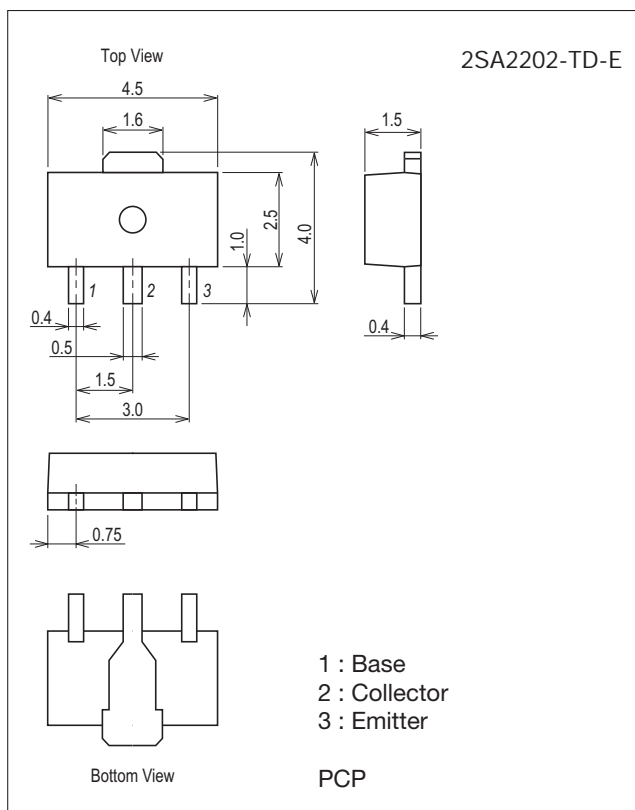

Product & Package Information

- Package : PCP
- JEITA, JEDEC : SC-62, SOT-89, TO-243
- Minimum Packing Quantity : 1,000 pcs./reel

Packing Type: TD

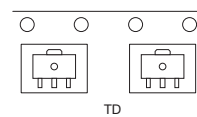

Marking

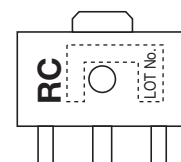

Electrical Connection

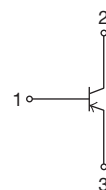

2SA2202

Continued from preceding page.

Parameter	Symbol	Conditions	Ratings	Unit
Base Current	I_B		-400	mA
Collector Dissipation	P_C	When mounted on ceramic substrate (250mm ² x0.8mm)	1.3	W
		$T_C=25^\circ\text{C}$	3.5	W
Junction Temperature	T_J		150	$^\circ\text{C}$
Storage Temperature	T_{stg}		-55 to +150	$^\circ\text{C}$

Electrical Characteristics at $T_a=25^\circ\text{C}$

Parameter	Symbol	Conditions	Ratings			Unit
			min	typ	max	
Collector Cutoff Current	I_{CBO}	$V_{CB}=-80\text{V}, I_E=0\text{A}$			-1	μA
Emitter Cutoff Current	I_{EBO}	$V_{EB}=-4\text{V}, I_C=0\text{A}$			-1	μA
DC Current Gain	h_{FE}	$V_{CE}=-5\text{V}, I_C=-100\text{mA}$	200		400	
Gain-Bandwidth Product	f_T	$V_{CE}=-10\text{V}, I_C=-500\text{mA}$		300		MHz
Output Capacitance	C_{ob}	$V_{CB}=-10\text{V}, f=1\text{MHz}$		23		pF
Collector to Emitter Saturation Voltage	$V_{CE(sat)}$	$I_C=-1\text{A}, I_B=-100\text{mA}$		-120	-240	mV
Base to Emitter Saturation Voltage	$V_{BE(sat)}$	$I_C=-1\text{A}, I_B=-100\text{mA}$		-0.85	-1.2	V
Collector to Base Breakdown Voltage	$V_{(BR)CBO}$	$I_C=-10\mu\text{A}, I_E=0\text{A}$	-100			V
Collector to Emitter Breakdown Voltage	$V_{(BR)CES}$	$I_C=-100\mu\text{A}, R_{BE}=0\Omega$	-100			V
	$V_{(BR)CEO}$	$I_C=-1\text{mA}, R_{BE}=\infty$	-100			V
Emitter to Base Breakdown Voltage	$V_{(BR)EBO}$	$I_E=-10\mu\text{A}, I_C=0\text{A}$	-7			V
Turn-ON Time	t_{on}			40		ns
Storage Time	t_{stg}	See specified Test Circuit.		600		ns
Fall Time	t_f			30		ns

Switching Time Test Circuit

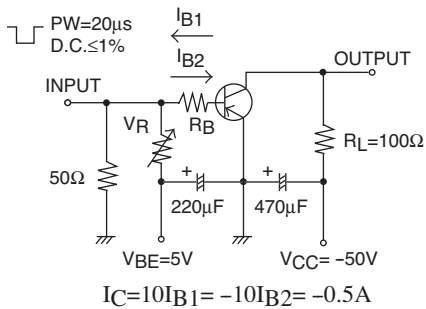

Ordering Information

Device	Package	Shipping	memo
2SA2202-TD-E	PCP	1,000pcs./reel	Pb Free

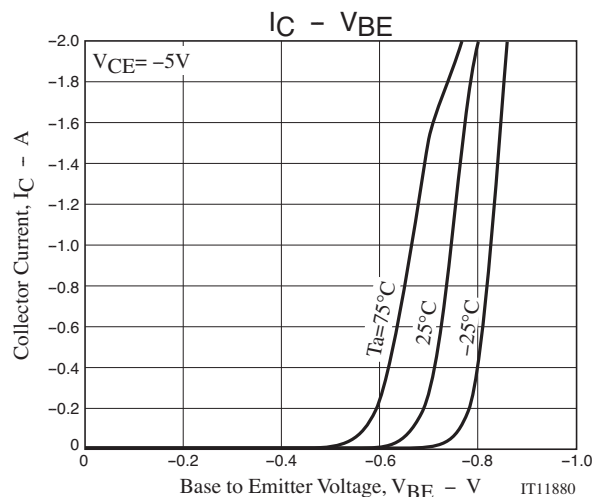
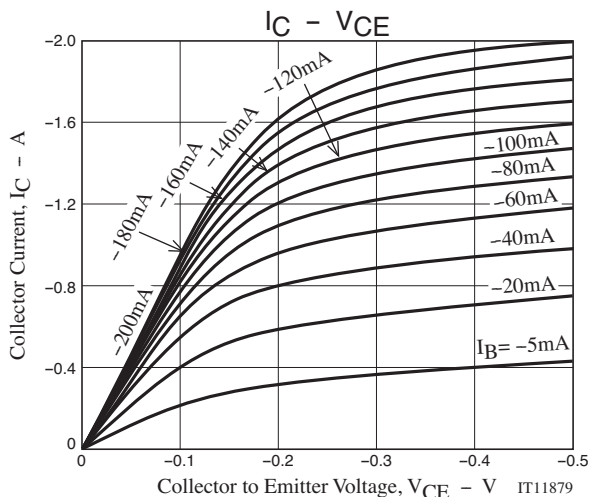

2SA2202

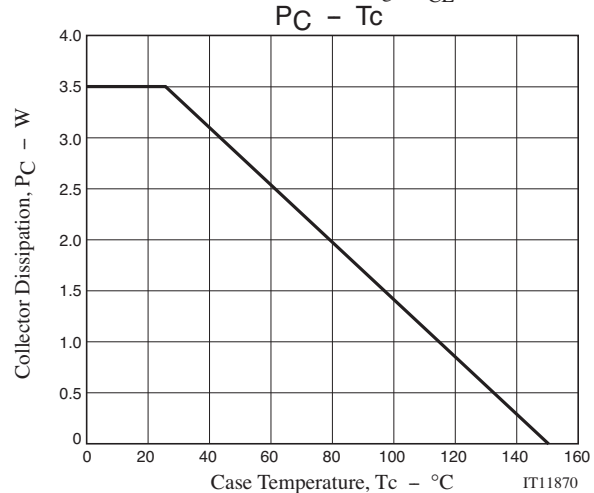
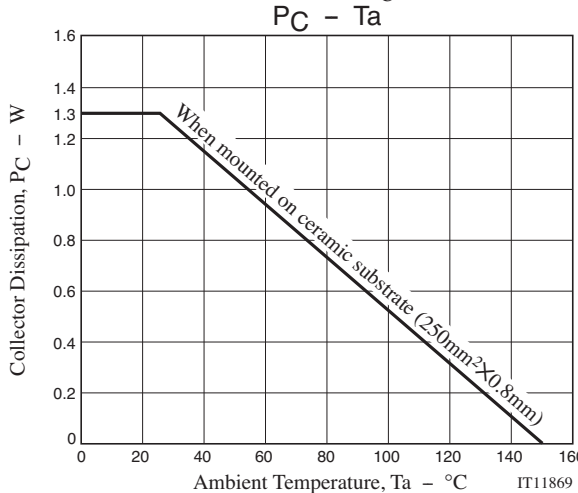
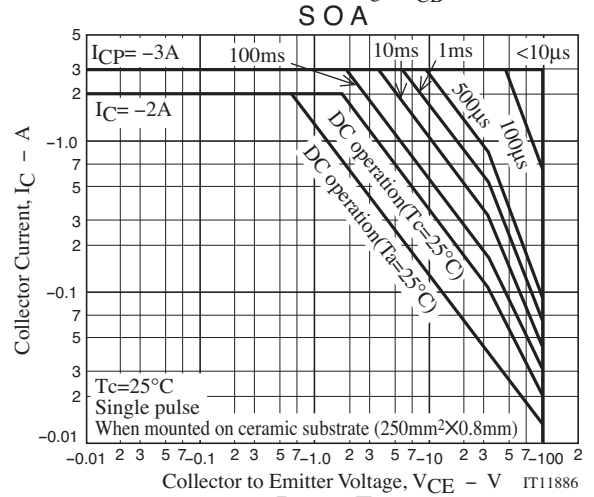
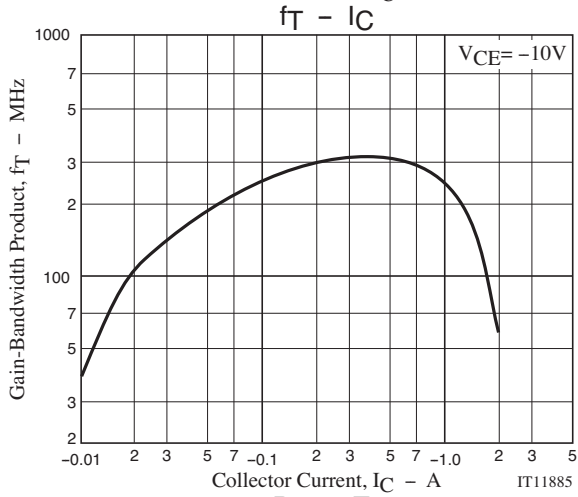
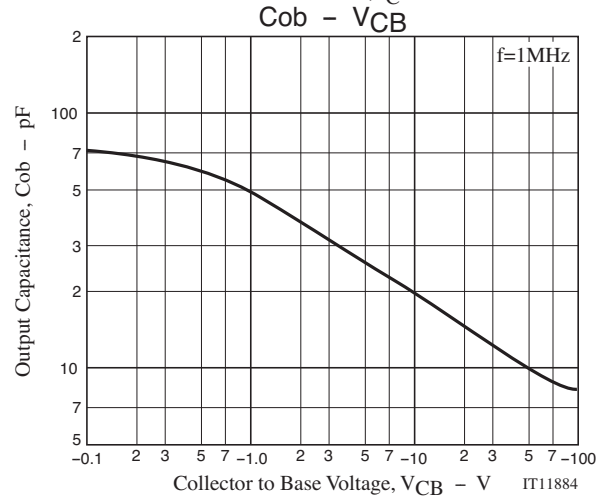
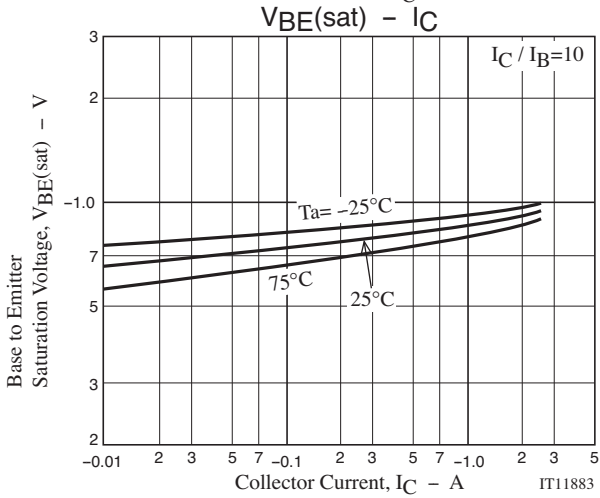
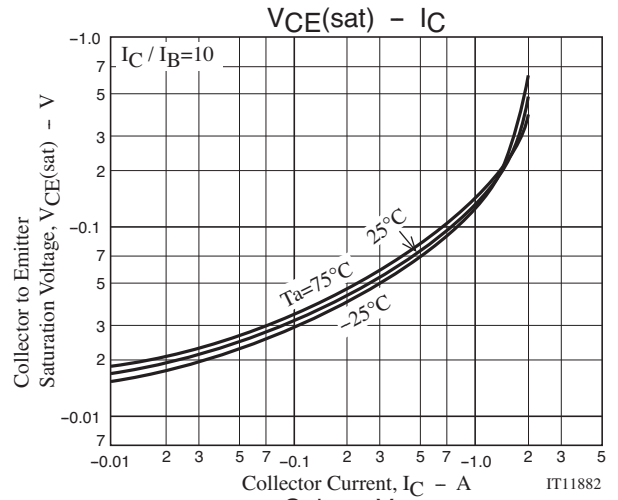
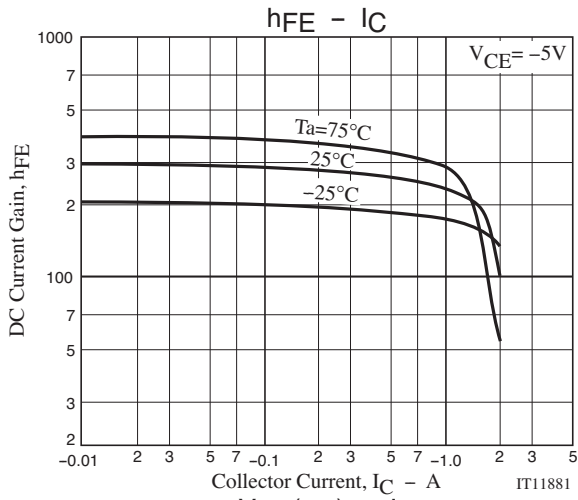

2SA2202

Outline Drawing

2SA2202-TD-E

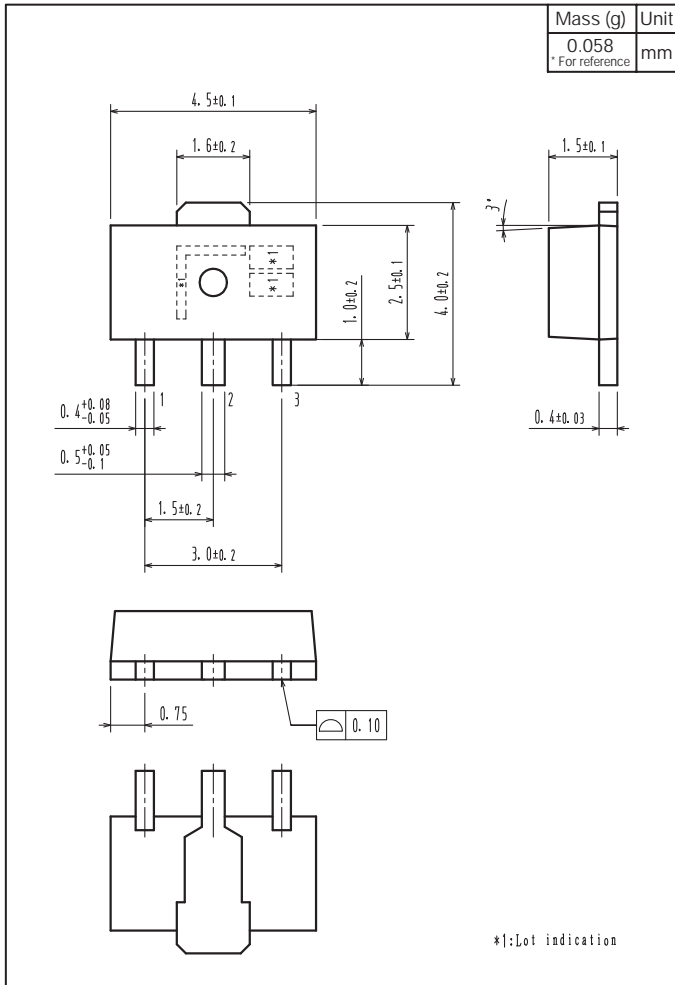

Land Pattern Example

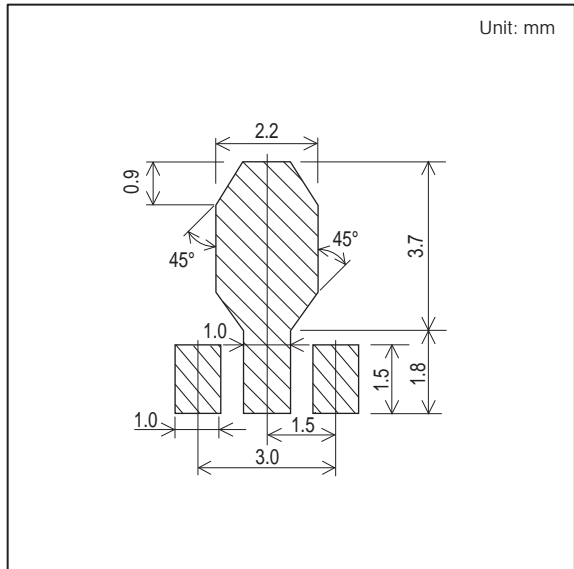

ON Semiconductor and the ON logo are registered trademarks of Semiconductor Components Industries, LLC (SCILLC). SCILLC owns the rights to a number of patents, trademarks, copyrights, trade secrets, and other intellectual property. A listing of SCILLC's product/patent coverage may be accessed at www.onsemi.com/site/pdf/Patent-Marking.pdf. SCILLC reserves the right to make changes without further notice to any products herein. SCILLC makes no warranty, representation or guarantee regarding the suitability of its products for any particular purpose, nor does SCILLC assume any liability arising out of the application or use of any product or circuit, and specifically disclaims any and all liability, including without limitation special, consequential or incidental damages. "Typical" parameters which may be provided in SCILLC data sheets and/or specifications can and do vary in different applications and actual performance may vary over time. All operating parameters, including "Typicals" must be validated for each customer application by customer's technical experts. SCILLC does not convey any license under its patent rights nor the rights of others. SCILLC products are not designed, intended, or authorized for use as components in systems intended for surgical implant into the body, or other applications intended to support or sustain life, or for any other application in which the failure of the SCILLC product could create a situation where personal injury or death may occur. Should Buyer purchase or use SCILLC products for any such unintended or unauthorized application, Buyer shall indemnify and hold SCILLC and its officers, employees, subsidiaries, affiliates, and distributors harmless against all claims, costs, damages, and expenses, and reasonable attorney fees arising out of, directly or indirectly, any claim of personal injury or death associated with such unintended or unauthorized use, even if such claim alleges that SCILLC was negligent regarding the design or manufacture of the part. SCILLC is an Equal Opportunity/Affirmative Action Employer. This literature is subject to all applicable copyright laws and is not for resale in any manner.

OUR CERTIFICATE

DiGi provide top-quality products and perfect service for customer worldwide through standardization, technological innovation and continuous improvement. DiGi through third-party certification, we stricly control the quality of products and services. Welcome your RFQ to

Email: Info@DiGi-Electronics.com



Tel: +00 852-30501935

RFQ Email: Info@DiGi-Electronics.com

DiGi is a global authorized distributor of electronic components.