

# 2SC4489S-AN Datasheet



<https://www.DiGi-Electronics.com>

DiGi Electronics Part Number	2SC4489S-AN-DG
Manufacturer	<a href="#">onsemi</a>
Manufacturer Product Number	2SC4489S-AN
Description	TRANS NPN 100V 2A 3NMP
Detailed Description	Bipolar (BJT) Transistor NPN 100 V 2 A 120MHz 1 W Through Hole 3-NMP



Tel: +00 852-30501935

RFQ Email: [Info@DiGi-Electronics.com](mailto:Info@DiGi-Electronics.com)

DiGi is a global authorized distributor of electronic components.

## Purchase and inquiry

Manufacturer Product Number:

25C4489S-AN

Series:

-

Transistor Type:

NPN

Voltage - Collector Emitter Breakdown (Max):

100 V

Current - Collector Cutoff (Max):

100nA (ICBO)

Power - Max:

1 W

Operating Temperature:

150°C (TJ)

Package / Case:

SC-71

Base Product Number:

25C4489

Manufacturer:

onsemi

Product Status:

Obsolete

Current - Collector (Ic) (Max):

2 A

Vce Saturation (Max) @ Ib, Ic:

400mV @ 100mA, 1A

DC Current Gain (hFE) (Min) @ Ic, Vce:

140 @ 100mA, 5V

Frequency - Transition:

120MHz

Mounting Type:

Through Hole

Supplier Device Package:

3-NMP

## Environmental & Export classification

Moisture Sensitivity Level (MSL):

1 (Unlimited)

ECCN:

EAR99

REACH Status:

REACH Unaffected

HTSUS:

8541.29.0075

Ordering number : EN3096A



# 2SA1709/2SC4489

## Bipolar Transistor (-100V, (-)2A, Low VCE(sat), (PNP)NPN Single NMP

ON Semiconductor®

<http://onsemi.com>

### Features

- Adoption of FBET, MBIT processes
- Fast switching speed
- High breakdown voltage, large current capacity

( )2SA1709

### Specifications

Absolute Maximum Ratings at Ta=25°C

Parameter	Symbol	Conditions	Ratings	Unit
Collector-to-Base Voltage	VCBO		(-)120	V
Collector-to-Emitter Voltage	VCEO		(-)100	V
Emitter-to-Base Voltage	VEBO		(-)6	V
Collector Current	IC		(-)2	A
Collector Current (Pulse)	ICP		(-)3	A
Collector Dissipation	PC		1	W
Junction Temperature	Tj		150	°C
Storage Temperature	Tstg		-55 to +150	°C

Stresses exceeding Maximum Ratings may damage the device. Maximum Ratings are stress ratings only. Functional operation above the Recommended Operating Conditions is not implied. Extended exposure to stresses above the Recommended Operating Conditions may affect device reliability.

### Package Dimensions

unit : mm (typ)

7540-001

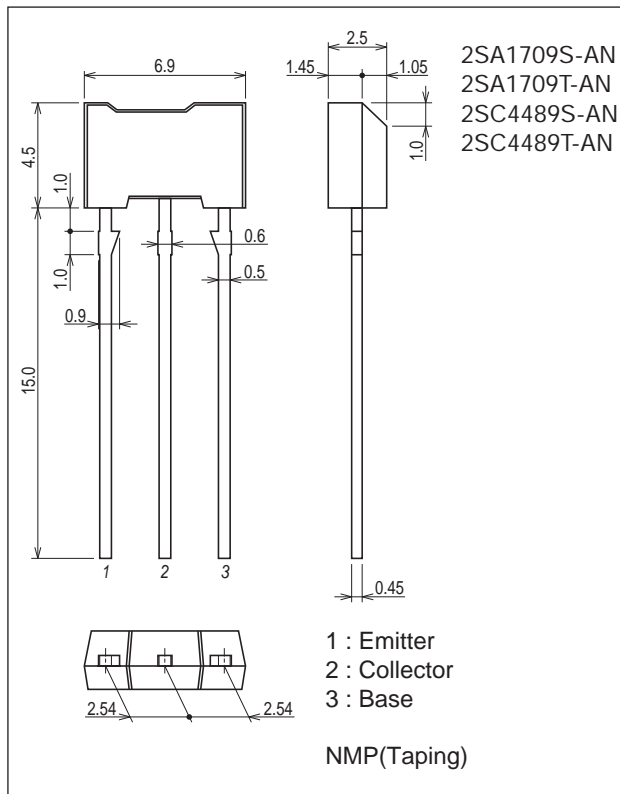

### Product & Package Information

- Package : NMP(Taping)
- JEITA, JEDEC : SC-71
- Minimum Packing Quantity : 2,500 pcs./box

### Marking(NMP(Taping))

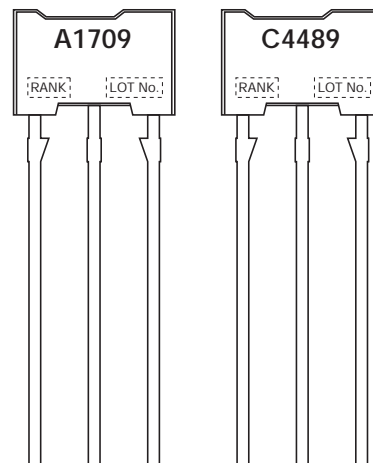

### Electrical Connection

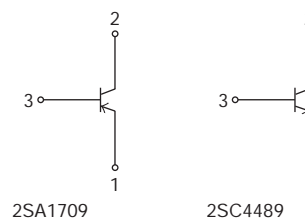

## 2SA1709 / 2SC4489

### Electrical Characteristics at Ta=25°C

Parameter	Symbol	Conditions	Ratings			Unit
			min	typ	max	
Collector Cutoff Current	ICBO	V <sub>CB</sub> =(-)100V, I <sub>E</sub> =0A			(-)100	nA
Emitter Cutoff Current	IEBO	V <sub>EB</sub> =(-)4V, I <sub>C</sub> =0A			(-)100	nA
DC Current Gain	h <sub>FE</sub>	V <sub>CE</sub> =(-)5V, I <sub>C</sub> =(-)100mA	140*		400*	
Gain-Bandwidth Product	f <sub>T</sub>	V <sub>CE</sub> =(-)10V, I <sub>C</sub> =(-)100mA		120		MHz
Output Capacitance	Cob	V <sub>CB</sub> =(-)10V, f=1MHz		(25)16		pF
Collector-to-Emitter Saturation Voltage	V <sub>CE(sat)</sub>	I <sub>C</sub> =(-)1A, I <sub>B</sub> =(-)100mA		(-0.22)0.13	(-0.6)0.4	V
Base-to-Emitter Saturation Voltage	V <sub>BE(sat)</sub>	I <sub>C</sub> =(-)1A, I <sub>B</sub> =(-)100mA		(-)0.85	(-)1.2	V
Collector-to-Base Breakdown Voltage	V <sub>(BR)CBO</sub>	I <sub>C</sub> =(-)10μA, I <sub>E</sub> =0A	(-)120			V
Collector-to-Emitter Breakdown Voltage	V <sub>(BR)CEO</sub>	I <sub>C</sub> =(-)1mA, R <sub>BE</sub> =∞	(-)100			V
Emitter-to-Base Breakdown Voltage	V <sub>(BR)EBO</sub>	I <sub>E</sub> =(-)10μA, I <sub>C</sub> =0A	(-)6			V
Turn-On Time	t <sub>on</sub>	See specified Test Circuit.		80		ns
Storage Time	t <sub>stg</sub>			(750)1000		ns
Fall Time	t <sub>f</sub>			(40)50		ns

\* : The 2SA1709/2SC4489 are classified by 100mA h<sub>FE</sub> as follows :

Rank	S	T
h <sub>FE</sub>	140 to 280	200 to 400

### Switching Time Test Circuit

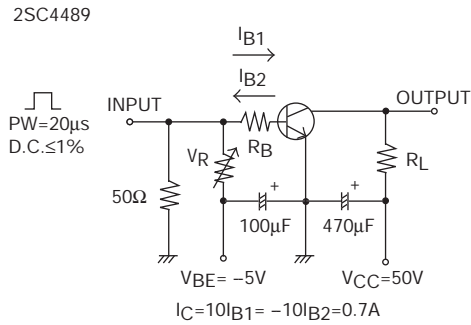
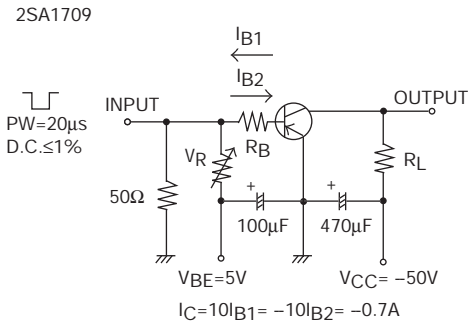

### Ordering Information

Device	Package	Shipping	memo
2SA1709S-AN	NMP(Taping)	2,500pcs./bag	Pb Free
2SA1709T-AN	NMP(Taping)	2,500pcs./bag	
2SC4489S-AN	NMP(Taping)	2,500pcs./bag	
2SC4489T-AN	NMP(Taping)	2,500pcs./bag	

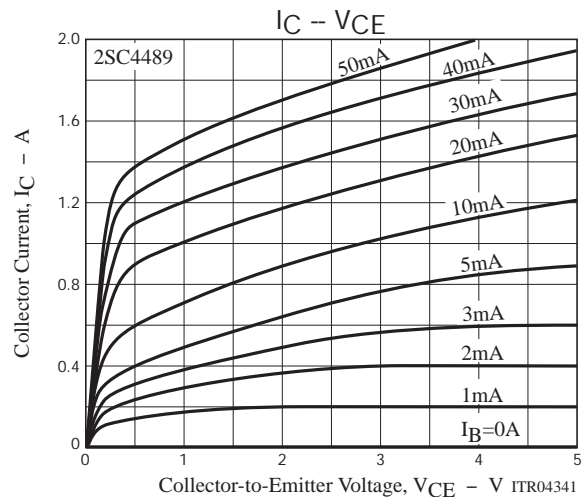
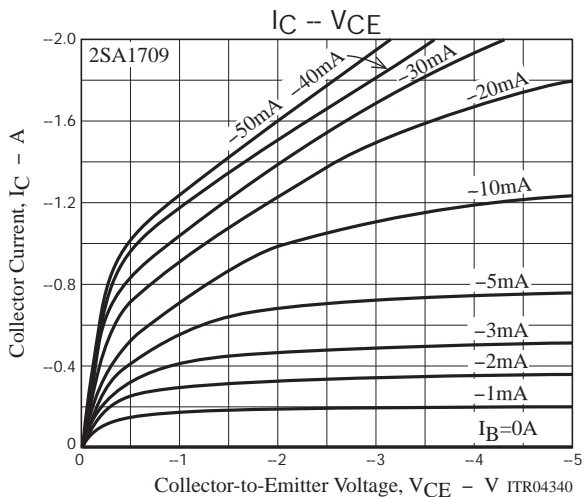

2SA1709 / 2SC4489

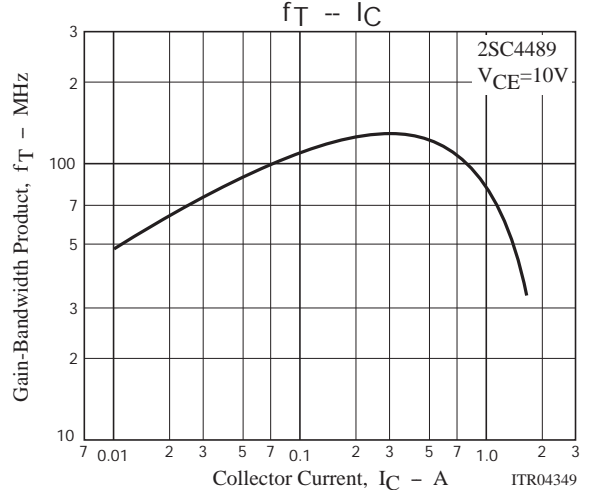
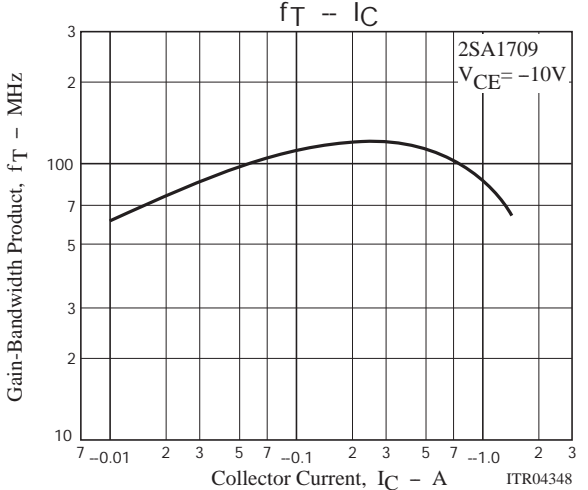
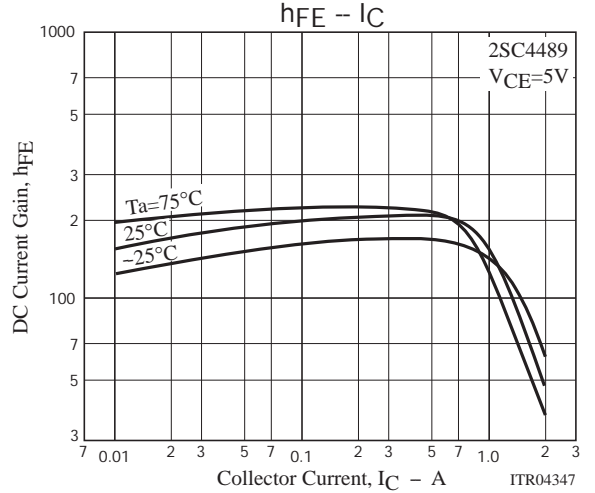
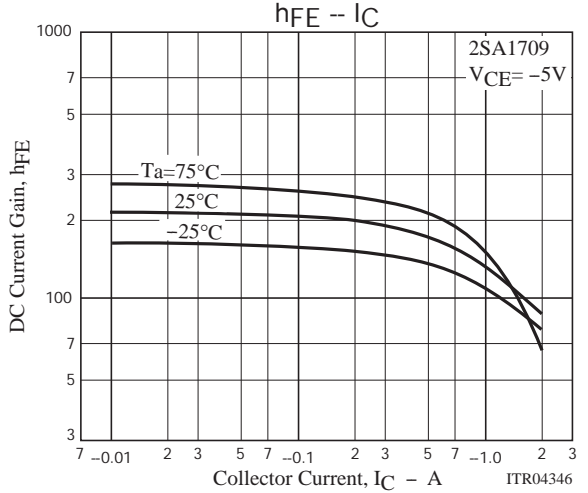
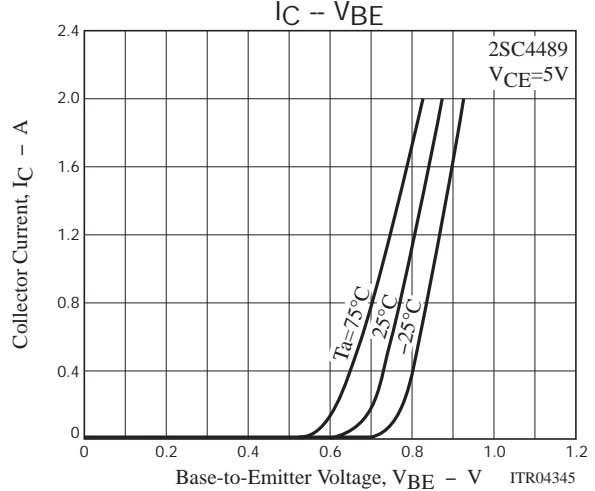
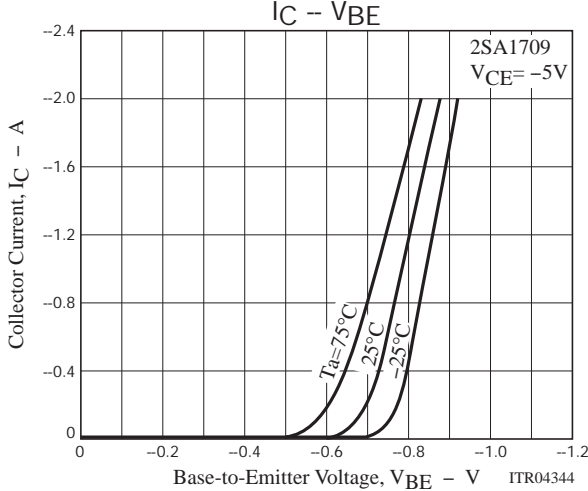
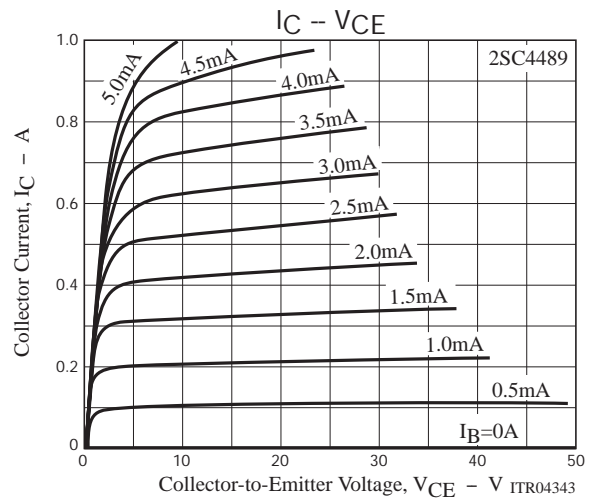
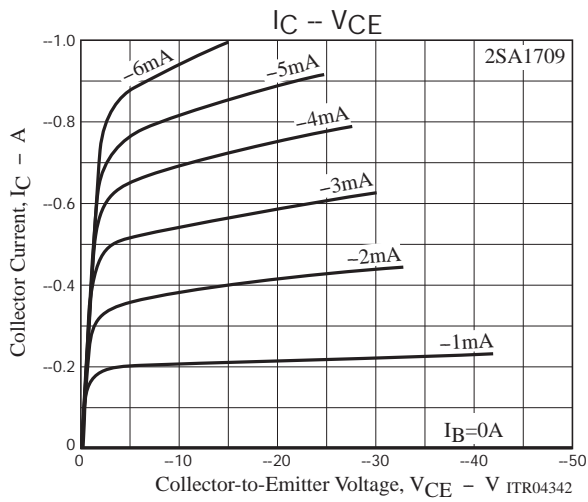

2SA1709 / 2SC4489

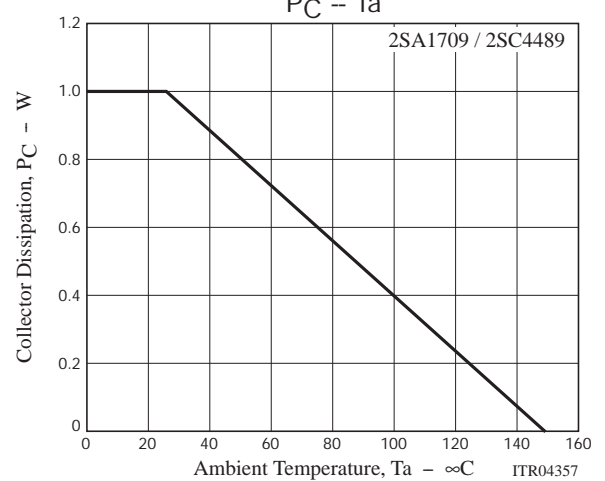
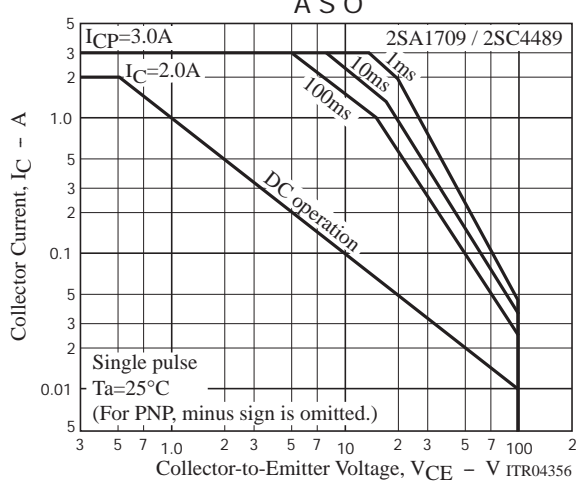
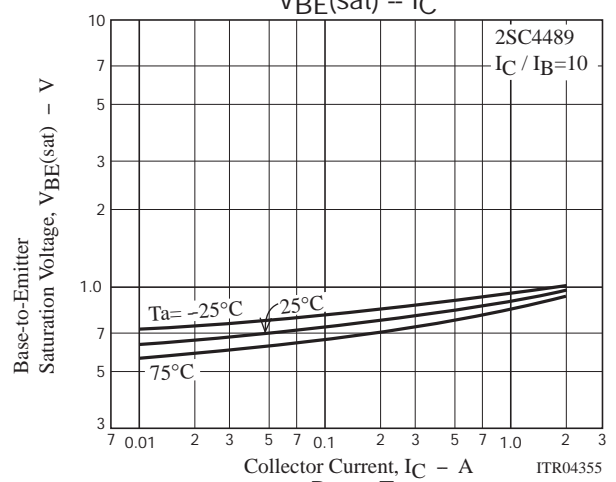
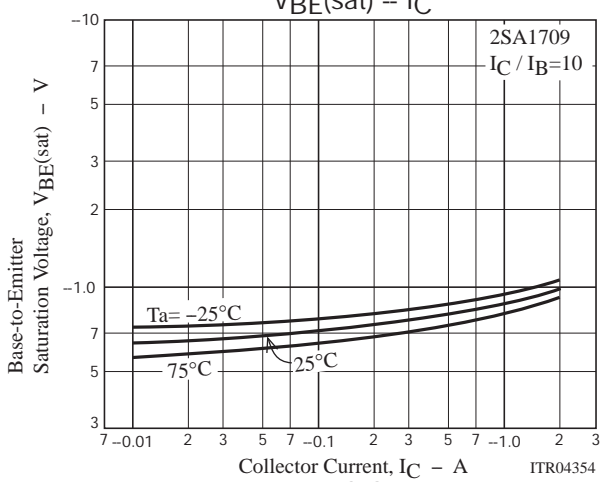
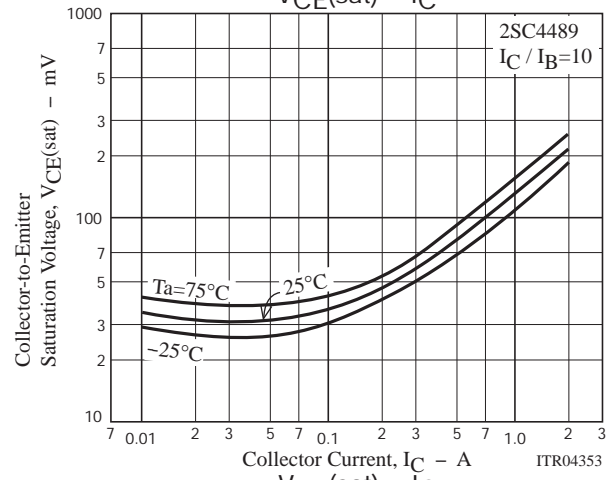
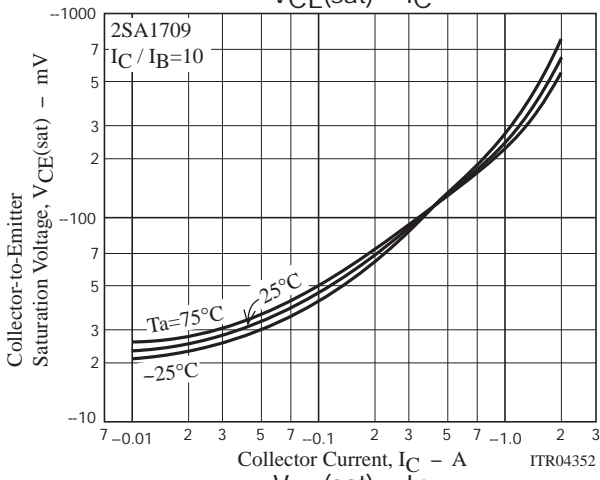
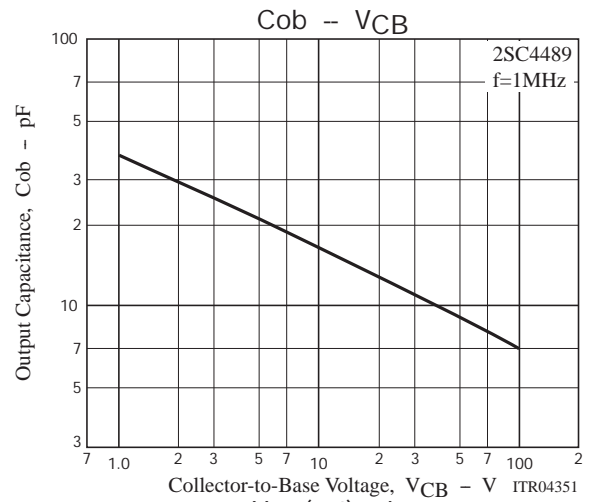
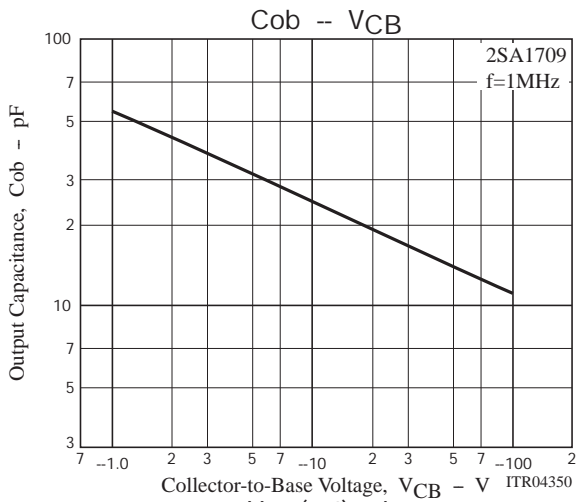

2SA1709 / 2SC4489

Bag Packing Specification

2SA1709S-AN, 2SA1709T-AN, 2SC4489S-AN, 2SC4489T-AN

NMP (Zigzag folding)

Storage package Outline name	Package type	Maximum Number of devices contained (pcs.)		Packing format	
		Inner box No.	Storage quantity	Outer box (C-6)	Outer box (C-8)
NMP	AN/AZ	C-3 Inner box Dimensions :mm(external) 330×45×125	2,500	8 inner boxes contained(20,000pcs.) Outer box Dimensions:mm(external) 585×345×195	4 inner boxes contained(10,000pcs.) Outer box Dimensions:mm(external) 345×300×195

1. Packing format

Packing method

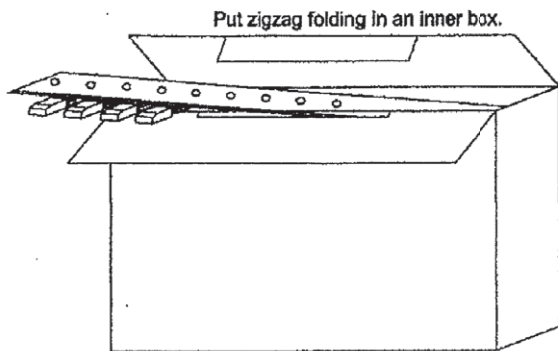

2. Bar code label

(Unit : mm)

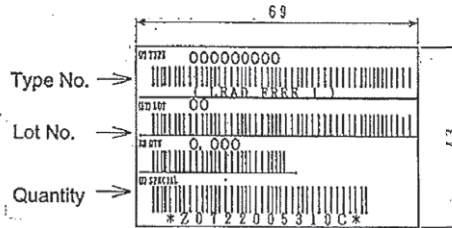

\* LEAD FREE 1 :

Lead-free External terminal surface treatment product.

2. Taping specifications

2-1. Carrier tape size (Unit:mm)

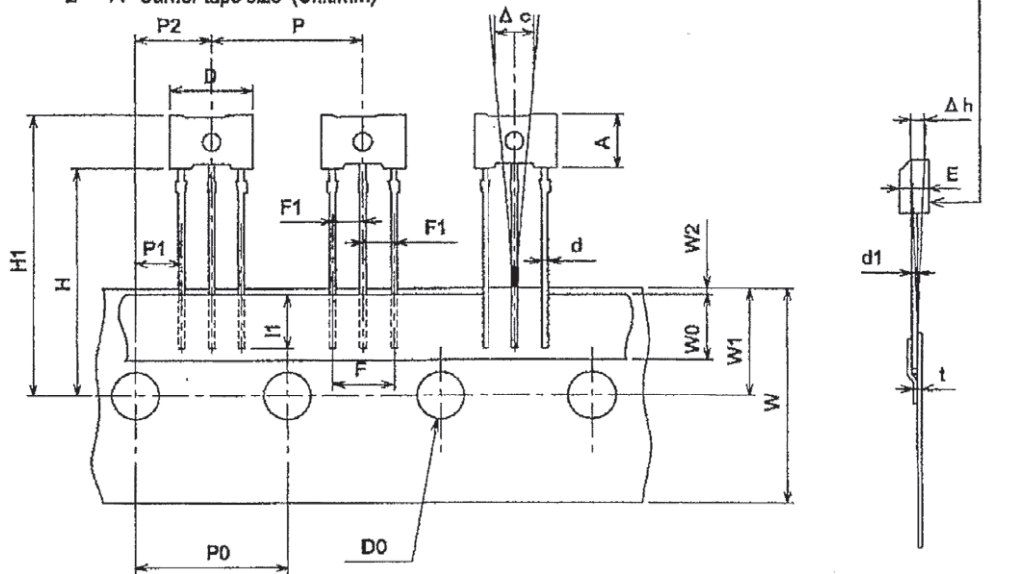

2-2. Taping size standard

Item	Symbol	Standard	Tolerance
Work piece outside diameter	D	6.9	±0.2
	E	2.5	±0.2
Work piece height	A	4.5	±0.2
Lead wire diameter	d	0.5	±0.1
Lead wire thickness	d1	0.45	±0.1
Bonded lead wire	I1	3.0MIN	
Pitch between products	P	12.7	±0.5
Pitch between perforations	P0	12.7	±0.2
Total pitch for 21 perforations	P0×20	254.0	±1.0
Distance between lead wire	F	5.0	+0.8 -0.2
Lead wire pitch distance	F1	2.54	+0.4 -0.1
Displacement of perforations	P1	3.81	±0.3
	P2	6.35	±0.3
Displacement of tape	W2	0~0.5	

Unit:mm

Item	Symbol	Standard	Tolerance
Tape width	W	18.0	±0.5
Adhesive tape	W0	6.0	±0.5
Displacement of perforations	W1	9.0	±0.5
Work piece bottom surface position	H	19.0	+1.0 -0.5
Work piece upper limit position	H1	23.5	±1.0
Perforations diameter	D0	φ4.0	±0.2
Tape thickness (total thickness)	t	0.6	±0.2
Product inclination	Δc	0	±0.7
Product inclination	Δh	0	±1.0

2SA1709 / 2SC4489

2—3. Taping structure

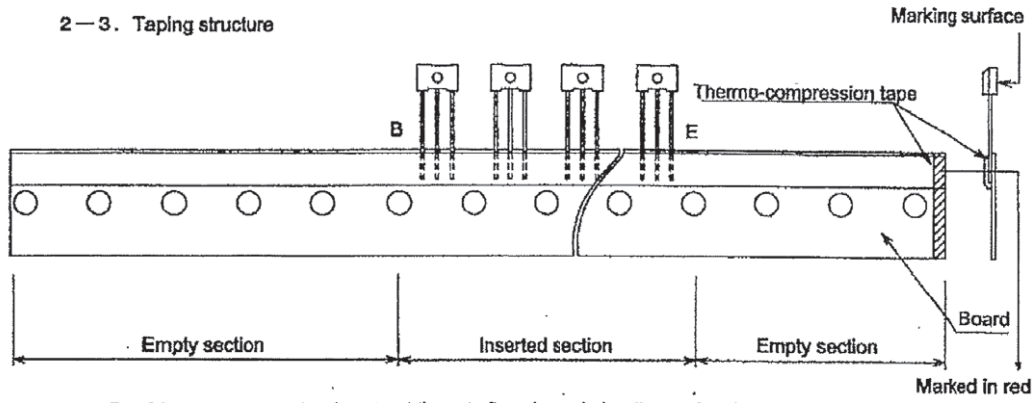

- Provide an empty section for about three to five pieces in leading and end portions of the tape.
- Provide an empty section in the fold-back portion.
- Provide marking in red to the E-side end of the board.

Outline Drawing

2SA1709S-AN, 2SA1709T-AN, 2SC4489S-AN, 2SC4489T-AN

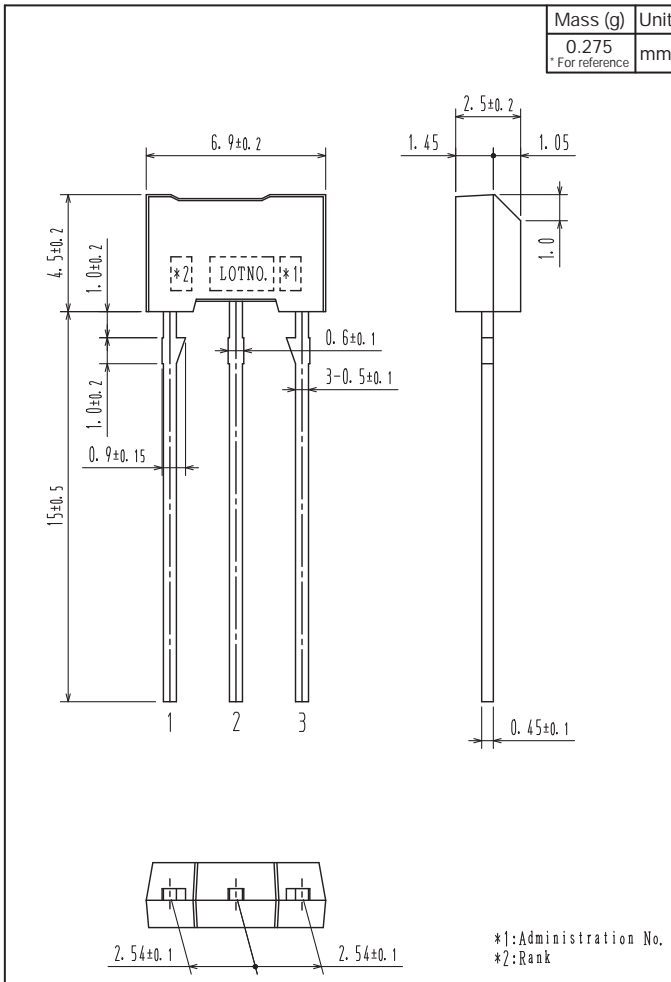



---

**2SA1709 / 2SC4489**

---

ON Semiconductor and the ON logo are registered trademarks of Semiconductor Components Industries, LLC (SCILLC). SCILLC owns the rights to a number of patents, trademarks, copyrights, trade secrets, and other intellectual property. A listing of SCILLC's product/patent coverage may be accessed at [www.onsemi.com/site/pdf/Patent-Marking.pdf](http://www.onsemi.com/site/pdf/Patent-Marking.pdf). SCILLC reserves the right to make changes without further notice to any products herein. SCILLC makes no warranty, representation or guarantee regarding the suitability of its products for any particular purpose, nor does SCILLC assume any liability arising out of the application or use of any product or circuit, and specifically disclaims any and all liability, including without limitation special, consequential or incidental damages. "Typical" parameters which may be provided in SCILLC data sheets and/or specifications can and do vary in different applications and actual performance may vary over time. All operating parameters, including "Typicals" must be validated for each customer application by customer's technical experts. SCILLC does not convey any license under its patent rights nor the rights of others. SCILLC products are not designed, intended, or authorized for use as components in systems intended for surgical implant into the body, or other applications intended to support or sustain life, or for any other application in which the failure of the SCILLC product could create a situation where personal injury or death may occur. Should Buyer purchase or use SCILLC products for any such unintended or unauthorized application, Buyer shall indemnify and hold SCILLC and its officers, employees, subsidiaries, affiliates, and distributors harmless against all claims, costs, damages, and expenses, and reasonable attorney fees arising out of, directly or indirectly, any claim of personal injury or death associated with such unintended or unauthorized use, even if such claim alleges that SCILLC was negligent regarding the design or manufacture of the part. SCILLC is an Equal Opportunity/Affirmative Action Employer. This literature is subject to all applicable copyright laws and is not for resale in any manner.

## OUR CERTIFICATE

DiGi provide top-quality products and perfect service for customer worldwide through standardization, technological innovation and continuous improvement. DiGi through third-party certification, we stricly control the quality of products and services. Welcome your RFQ to

Email: [Info@DiGi-Electronics.com](mailto:Info@DiGi-Electronics.com)



Tel: +00 852-30501935

RFQ Email: [Info@DiGi-Electronics.com](mailto:Info@DiGi-Electronics.com)

DiGi is a global authorized distributor of electronic components.