

BC558C_J35Z Datasheet

www.digi-electronics.com



<https://www.DiGi-Electronics.com>

DiGi Electronics Part Number	BC558C_J35Z-DG
Manufacturer	onsemi
Manufacturer Product Number	BC558C_J35Z
Description	TRANS PNP 30V 0.1A TO92-3
Detailed Description	Bipolar (BJT) Transistor PNP 30 V 100 mA 150MHz 500 mW Through Hole TO-92-3



Tel: +00 852-30501935

RFQ Email: Info@DiGi-Electronics.com

DiGi is a global authorized distributor of electronic components.

Purchase and inquiry

Manufacturer Product Number:

BC558C_J35Z

Series:

-

Transistor Type:

PNP

Voltage - Collector Emitter Breakdown (Max):

30 V

Current - Collector Cutoff (Max):

15nA (ICBO)

Power - Max:

500 mW

Operating Temperature:

150°C (TJ)

Package / Case:

TO-226-3, TO-92-3 (TO-226AA) Formed Leads

Base Product Number:

BC558

Manufacturer:

onsemi

Product Status:

Obsolete

Current - Collector (Ic) (Max):

100 mA

Vce Saturation (Max) @ Ib, Ic:

650mV @ 5mA, 100mA

DC Current Gain (hFE) (Min) @ Ic, Vce:

420 @ 2mA, 5V

Frequency - Transition:

150MHz

Mounting Type:

Through Hole

Supplier Device Package:

TO-92-3

Environmental & Export classification

Moisture Sensitivity Level (MSL):

1 (Unlimited)

ECCN:

EAR99

REACH Status:

REACH Unaffected

HTSUS:

8541.21.0075

PNP Epitaxial Silicon Transistor

BC556, BC557, BC558, BC559, BC560

Features

- Switching and Amplifier
- High-Voltage: BC556, $V_{CEO} = -65$ V
- Low-Noise: BC559, BC560
- Complement to BC546, BC547, BC548, BC549, and BC550
- These Devices are Pb-Free, Halogen Free/BFR Free and are RoHS Compliant

ABSOLUTE MAXIMUM RATINGS ($T_A = 25^\circ\text{C}$ unless otherwise noted)

Parameter	Symbol	Value	Unit
Collector - Base Voltage	V_{CBO}	-80	V
BC556			
BC557 / BC560			
BC558 / BC559	-50		
Collector - Emitter Voltage	V_{CEO}	-65	V
BC556			
BC557 / BC560			
BC558 / BC559	-45		
Emitter - Base Voltage	V_{EBO}	-5	V
Collector Current (DC)	I_C	-100	mA
Peak Collector Current (Pulse)	I_{CP}	-200	mA
Peak Base Current (Pulse)	I_{BP}	-200	mA
Junction Temperature	T_J	150	$^\circ\text{C}$
Storage Temperature Range	T_{STG}	-65 to +150	$^\circ\text{C}$

Stresses exceeding those listed in the Maximum Ratings table may damage the device. If any of these limits are exceeded, device functionality should not be assumed, damage may occur and reliability may be affected.

THERMAL CHARACTERISTICS (Note 1)

($T_A = 25^\circ\text{C}$ unless otherwise noted)

Parameter	Symbol	Max.	Unit
Total Device Dissipation Derate above 25°C	P_D	500 4.0	mW mW/ $^\circ\text{C}$
Thermal Resistance, Junction-to-Ambient	$R_{\theta JA}$	250	$^\circ\text{C}/\text{W}$

1. PCB size: FR-4, 76 mm x 114 mm x 1.57 mm (3.0 inch x 4.5 inch x 0.062 inch) with minimum land pattern size.

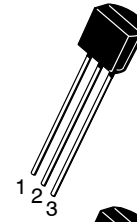

**TO-92-3
CASE 135AN**
Straight Lead
Bulk Packing

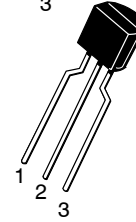

**TO-92-3
CASE 135AR**
Bent Lead
Tape & Reel
Fan-Fold

1. Collector
2. Base
3. Emitter

MARKING DIAGRAM

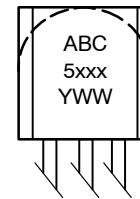

- A = Assembly Location
BC5xxx = Specific Device Code
xxx = 56A, 56B, 57A, 57B,
58B, 59B, 59C, 60C
Y = Year
WW = Work Week

ORDERING INFORMATION

See detailed ordering and shipping information on page 2 of this data sheet.

NOTE: Some of the devices on this data sheet have been **DISCONTINUED**. Please refer to the table on page 2.

BC556, BC557, BC558, BC559, BC560**ELECTRICAL CHARACTERISTICS** ($T_A = 25^\circ\text{C}$ unless otherwise noted)

Symbol	Parameter	Conditions	Min.	Typ.	Max.	Unit
I_{CBO}	Collector Cut-Off Current	$V_{CB} = -30\text{ V}, I_E = 0$			-15	nA
h_{FE}	DC Current Gain	$V_{CE} = -5\text{ V}, I_C = -2\text{ mA}$	110		800	
$V_{CE(sat)}$	Collector-Emitter Saturation Voltage	$I_C = -10\text{ mA}, I_B = -0.5\text{ mA}$		-90	-300	mV
		$I_C = -100\text{ mA}, I_B = -5\text{ mA}$		-250	-650	
$V_{BE(sat)}$	Collector-Base Saturation Voltage	$I_C = -10\text{ mA}, I_B = -0.5\text{ mA}$		-700		mV
		$I_C = -100\text{ mA}, I_B = -5\text{ mA}$		-900		
$V_{BE(on)}$	Base-Emitter On Voltage	$V_{CE} = -5\text{ V}, I_C = -2\text{ mA}$	-600	-660	-750	mV
		$V_{CE} = -5\text{ V}, I_C = -10\text{ mA}$			-800	
f_T	Current Gain Bandwidth Product	$V_{CE} = -5\text{ V}, I_C = -10\text{ mA}, f = 10\text{ MHz}$		150		MHz
C_{ob}	Output Capacitance	$V_{CB} = -10\text{ V}, I_E = 0, f = 1\text{ MHz}$			6	pF
NF	Noise Figure	BC556 / BC557 / BC558	$V_{CE} = -5\text{ V}, I_C = -200\text{ }\mu\text{A}, f = 1\text{ kHz}, R_G = 2\text{ k}\Omega$	2	10	dB
		BC559 / BC560		1	4	
		BC559		1.2	4.0	
		BC560		1.2	2.0	

Product parametric performance is indicated in the Electrical Characteristics for the listed test conditions, unless otherwise noted. Product performance may not be indicated by the Electrical Characteristics if operated under different conditions.

 h_{FE} CLASSIFICATION

Classification	A	B	C
h_{FE2}	110 ~ 220	200 ~ 450	420 ~ 800

ORDERING INFORMATION

Part Number	Marking	Package	Shipping [†]
BC559CTA	BC559C	TO-92-3, case 135AR (Pb-Free)	2,000 Units/ Fan-Fold

DISCONTINUED (Note 2)

BC556ABU	BC556A	TO-92-3, case 135AN (Pb-Free)	10,000 Units/ Bulk Box
BC556ATA	BC556A	TO-92-3, case 135AR (Pb-Free)	2,000 Units/ Fan-Fold
BC556BTA	BC556B	TO-92-3, case 135AR (Pb-Free)	2,000 Units/ Fan-Fold
BC556BTF	BC556B	TO-92-3, case 135AR (Pb-Free)	2,000 Units/ Tape & Reel
BC556BTFR	BC556B	TO-92-3, case 135AR (Pb-Free)	2,000 Units/ Tape & Reel
BC557ATA	BC557A	TO-92-3, case 135AR (Pb-Free)	2,000 Units/ Fan-Fold
BC557BTA	BC557B	TO-92-3, case 135AR (Pb-Free)	2,000 Units/ Fan-Fold
BC557BTF	BC557B	TO-92-3, case 135AR (Pb-Free)	2,000 Units/ Tape & Reel
BC558BTA	BC558B	TO-92-3, case 135AR (Pb-Free)	2,000 Units/ Fan-Fold
BC559BTA	BC559B	TO-92-3, case 135AR (Pb-Free)	2,000 Units/ Fan-Fold
BC560CTA	BC560C	TO-92-3, case 135AR (Pb-Free)	2,000 Units/ Fan-Fold

[†]For information on tape and reel specifications, including part orientation and tape sizes, please refer to our Tape and Reel Packaging Specification Brochure, BRD8011/D.

2. **DISCONTINUED:** These devices are not recommended for new design. Please contact your onsemi representative for information. The most current information on these devices may be available on www.onsemi.com.

BC556, BC557, BC558, BC559, BC560

TYPICAL PERFORMANCE CHARACTERISTICS

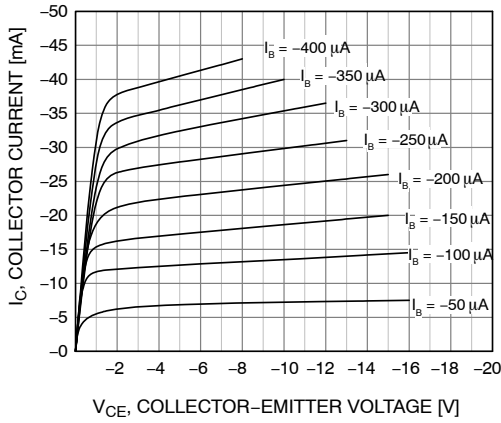

Figure 1. Static Characteristic

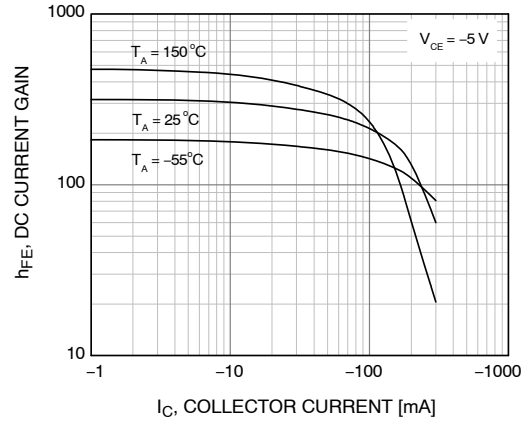

Figure 2. DC Current Gain

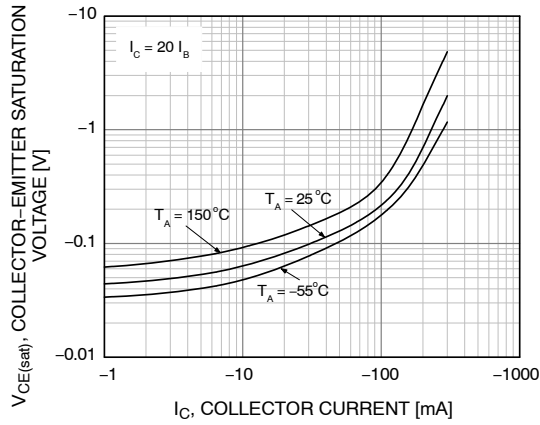

Figure 3. Collector-Emitter Saturation Voltage

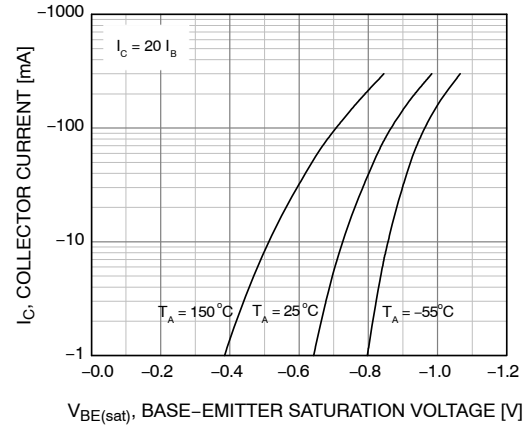

Figure 4. Base-Emitter Saturation Voltage

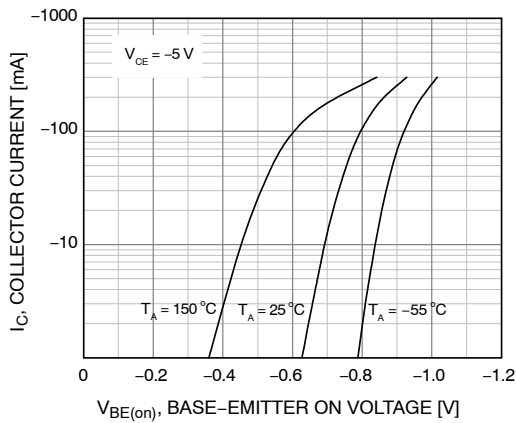

Figure 5. Base-Emitter On Voltage

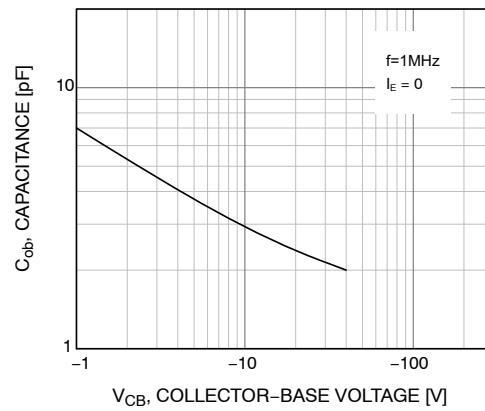

Figure 6. Collector Output Capacitance

BC556, BC557, BC558, BC559, BC560

TYPICAL PERFORMANCE CHARACTERISTICS (continued)

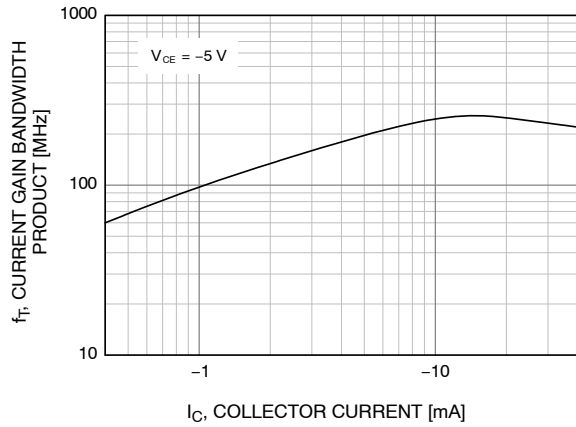

Figure 7. Current Gain Bandwidth Product

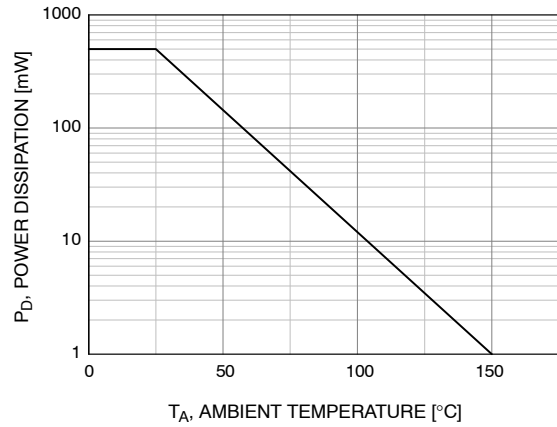

Figure 8. Power Deration

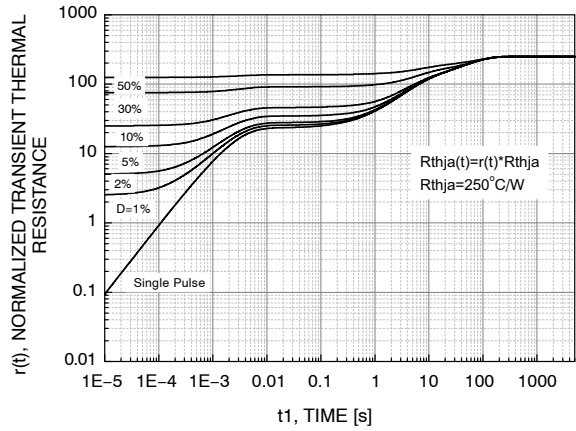
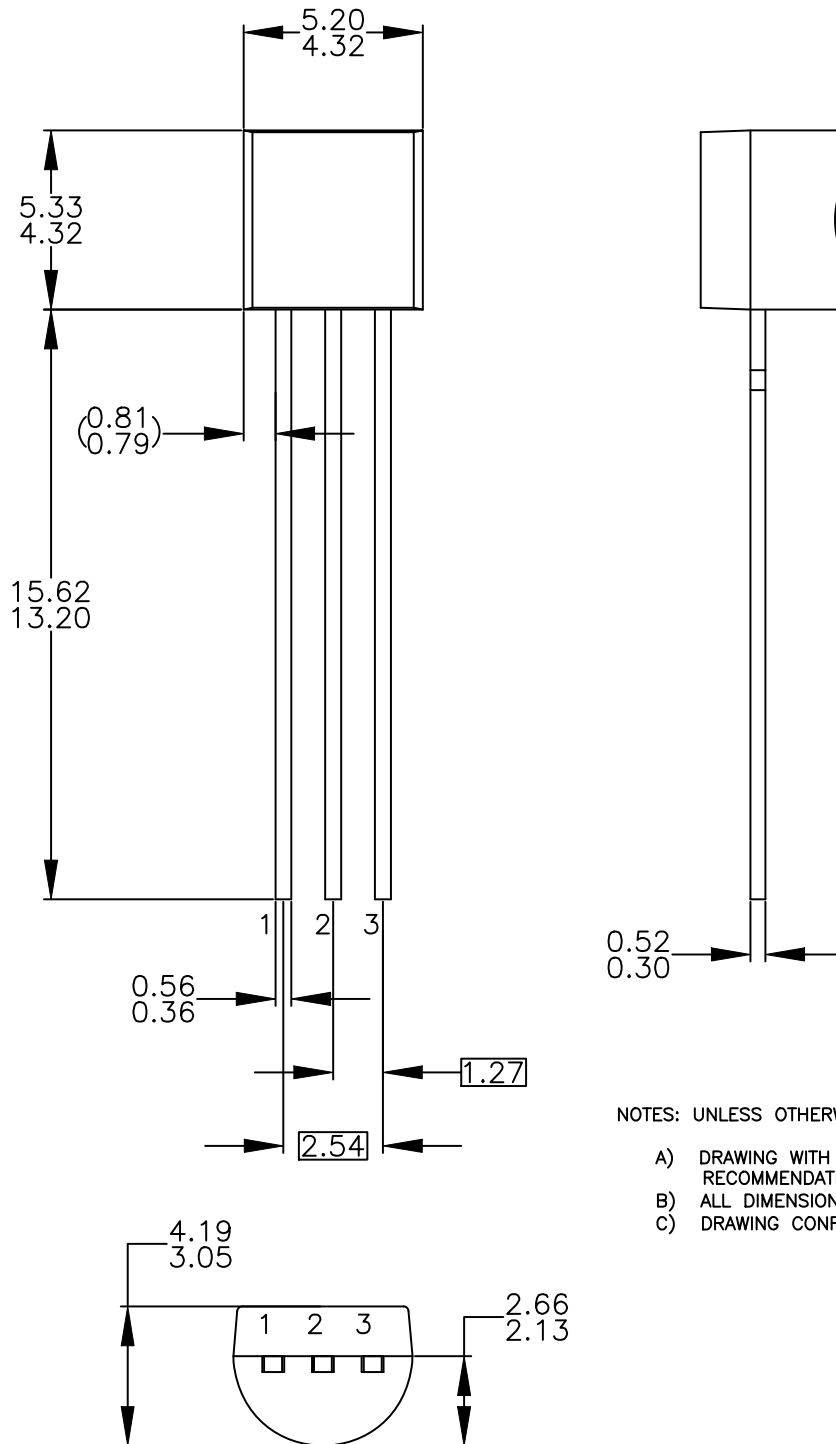

Figure 9. Normalized Transient Thermal Resistance

TO-92 3 4.825x4.76
CASE 135AN
ISSUE O

DATE 31 JUL 2016



NOTES: UNLESS OTHERWISE SPECIFIED

- A) DRAWING WITH REFERENCE TO JEDEC TO-92 RECOMMENDATIONS.
- B) ALL DIMENSIONS ARE IN MILLIMETERS.
- C) DRAWING CONFORMS TO ASME Y14.5M-2009.

DOCUMENT NUMBER:	98AON13880G	Electronic versions are uncontrolled except when accessed directly from the Document Repository. Printed versions are uncontrolled except when stamped "CONTROLLED COPY" in red.
DESCRIPTION:	TO-92 3 4.825X4.76	PAGE 1 OF 1

onsemi and ONSEMI are trademarks of Semiconductor Components Industries, LLC dba onsemi or its subsidiaries in the United States and/or other countries. onsemi reserves the right to make changes without further notice to any products herein. onsemi makes no warranty, representation or guarantee regarding the suitability of its products for any particular purpose, nor does onsemi assume any liability arising out of the application or use of any product or circuit, and specifically disclaims any and all liability, including without limitation special, consequential or incidental damages. onsemi does not convey any license under its patent rights nor the rights of others.

TO-92 3 4.83x4.76 LEADFORMED
CASE 135AR
ISSUE O

DATE 30 SEP 2016

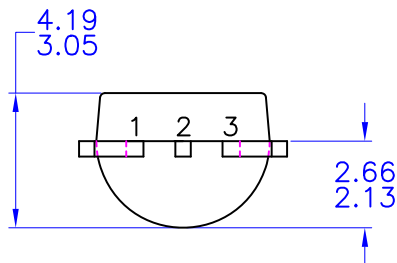
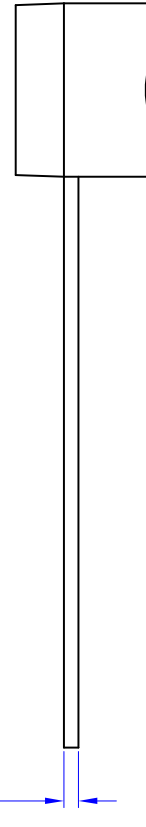
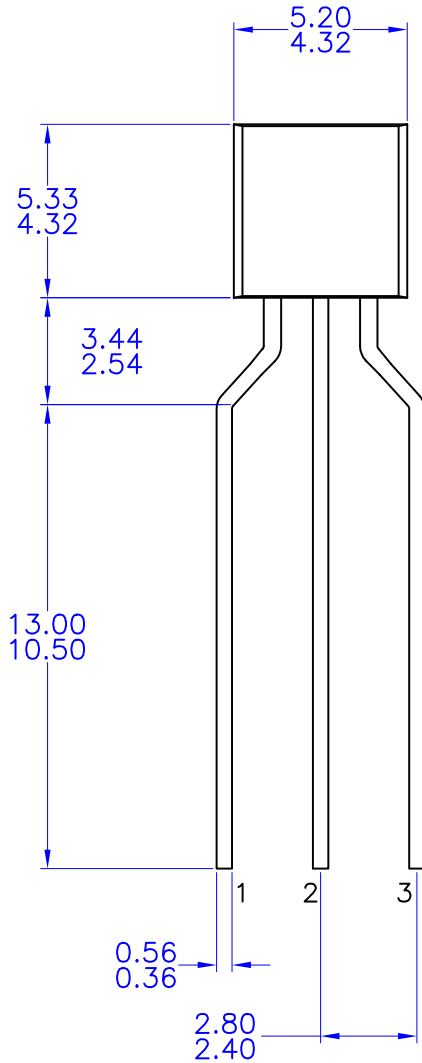

NOTES: UNLESS OTHERWISE SPECIFIED

- A) DRAWING WITH REFERENCE TO JEDEC TO-92 RECOMMENDATIONS.
- B) ALL DIMENSIONS ARE IN MILLIMETERS.
- C) DRAWING CONFORMS TO ASME Y14.5M-1994

DOCUMENT NUMBER:	98AON13879G	Electronic versions are uncontrolled except when accessed directly from the Document Repository. Printed versions are uncontrolled except when stamped "CONTROLLED COPY" in red.
DESCRIPTION:	TO-92 3 4.83X4.76 LEADFORMED	PAGE 1 OF 1

onsemi and ONSEMI are trademarks of Semiconductor Components Industries, LLC dba onsemi or its subsidiaries in the United States and/or other countries. onsemi reserves the right to make changes without further notice to any products herein. onsemi makes no warranty, representation or guarantee regarding the suitability of its products for any particular purpose, nor does onsemi assume any liability arising out of the application or use of any product or circuit, and specifically disclaims any and all liability, including without limitation special, consequential or incidental damages. onsemi does not convey any license under its patent rights nor the rights of others.

onsemi, **Onsemi**, and other names, marks, and brands are registered and/or common law trademarks of Semiconductor Components Industries, LLC dba "**onsemi**" or its affiliates and/or subsidiaries in the United States and/or other countries. **onsemi** owns the rights to a number of patents, trademarks, copyrights, trade secrets, and other intellectual property. A listing of **onsemi**'s product/patent coverage may be accessed at www.onsemi.com/site/pdf/Patent-Marking.pdf. **onsemi** reserves the right to make changes at any time to any products or information herein, without notice. The information herein is provided "as-is" and **onsemi** makes no warranty, representation or guarantee regarding the accuracy of the information, product features, availability, functionality, or suitability of its products for any particular purpose, nor does **onsemi** assume any liability arising out of the application or use of any product or circuit, and specifically disclaims any and all liability, including without limitation special, consequential or incidental damages. Buyer is responsible for its products and applications using **onsemi** products, including compliance with all laws, regulations and safety requirements or standards, regardless of any support or applications information provided by **onsemi**. "Typical" parameters which may be provided in **onsemi** data sheets and/or specifications can and do vary in different applications and actual performance may vary over time. All operating parameters, including "Typicals" must be validated for each customer application by customer's technical experts. **onsemi** does not convey any license under any of its intellectual property rights nor the rights of others. **onsemi** products are not designed, intended, or authorized for use as a critical component in life support systems or any FDA Class 3 medical devices or medical devices with a same or similar classification in a foreign jurisdiction or any devices intended for implantation in the human body. Should Buyer purchase or use **onsemi** products for any such unintended or unauthorized application, Buyer shall indemnify and hold **onsemi** and its officers, employees, subsidiaries, affiliates, and distributors harmless against all claims, costs, damages, and expenses, and reasonable attorney fees arising out of, directly or indirectly, any claim of personal injury or death associated with such unintended or unauthorized use, even if such claim alleges that **onsemi** was negligent regarding the design or manufacture of the part. **onsemi** is an Equal Opportunity/Affirmative Action Employer. This literature is subject to all applicable copyright laws and is not for resale in any manner.

ADDITIONAL INFORMATION

TECHNICAL PUBLICATIONS:

Technical Library: www.onsemi.com/design/resources/technical-documentation
onsemi Website: www.onsemi.com

ONLINE SUPPORT: www.onsemi.com/support

For additional information, please contact your local Sales Representative at www.onsemi.com/support/sales

OUR CERTIFICATE

DiGi provide top-quality products and perfect service for customer worldwide through standardization, technological innovation and continuous improvement. DiGi through third-party certification, we strictly control the quality of products and services. Welcome your RFQ to

Email: Info@DiGi-Electronics.com



Tel: +00 852-30501935

RFQ Email: Info@DiGi-Electronics.com

DiGi is a global authorized distributor of electronic components.