

# BC63916-D74Z Datasheet

[www.digi-electronics.com](http://www.digi-electronics.com)



<https://www.DiGi-Electronics.com>

DiGi Electronics Part Number	BC63916-D74Z-DG
Manufacturer	<a href="#">onsemi</a>
Manufacturer Product Number	BC63916-D74Z
Description	TRANS NPN 80V 1A TO92-3
Detailed Description	Bipolar (BJT) Transistor NPN 80 V 1 A 100MHz 1 W Through Hole TO-92-3



Tel: +00 852-30501935

RFQ Email: [Info@DiGi-Electronics.com](mailto:Info@DiGi-Electronics.com)

DiGi is a global authorized distributor of electronic components.

## Purchase and inquiry

Manufacturer Product Number:

BC63916-D74Z

Series:

-

Transistor Type:

NPN

Voltage - Collector Emitter Breakdown (Max):

80 V

Current - Collector Cutoff (Max):

100nA (ICBO)

Power - Max:

1 W

Operating Temperature:

-55°C ~ 150°C (TJ)

Package / Case:

TO-226-3, TO-92-3 (TO-226AA) Formed Leads

Base Product Number:

BC63916

Manufacturer:

onsemi

Product Status:

Active

Current - Collector (Ic) (Max):

1 A

Vce Saturation (Max) @ Ib, Ic:

500mV @ 50mA, 500mA

DC Current Gain (hFE) (Min) @ Ic, Vce:

100 @ 150mA, 2V

Frequency - Transition:

100MHz

Mounting Type:

Through Hole

Supplier Device Package:

TO-92-3

## Environmental & Export classification

RoHS Status:

ROHS3 Compliant

REACH Status:

REACH Unaffected

HTSUS:

8541.29.0075

Moisture Sensitivity Level (MSL):

Not Applicable

ECCN:

EAR99

# NPN Epitaxial Silicon Transistor

## BC63916

### Features

- Switching and Amplifier Applications
- These are Pb-Free Devices

### ABSOLUTE MAXIMUM RATINGS (Note 1)

(Values are at  $T_A = 25^\circ\text{C}$  unless otherwise noted.)

Symbol	Parameter	Value	Unit
$V_{CER}$	Collector-Emitter Voltage at $R_{BE} = 1\text{ k}\Omega$	100	V
$V_{CES}$	Collector-Emitter Voltage	100	V
$V_{CEO}$	Collector-Emitter Voltage	80	V
$V_{EBO}$	Emitter-Base Voltage	5	V
$I_C$	Collector Current	1	A
$T_J, T_{STG}$	Operating and Storage Junction Temperature Range	-55 to 150	$^\circ\text{C}$

Stresses exceeding those listed in the Maximum Ratings table may damage the device. If any of these limits are exceeded, device functionality should not be assumed, damage may occur and reliability may be affected.

1. Pulse Test: Pulse Width  $\leq 300\ \mu\text{s}$ , Duty Cycle  $\leq 2\%$ .

### THERMAL CHARACTERISTICS (Note 2)

(Values are at  $T_A = 25^\circ\text{C}$  unless otherwise noted.)

Symbol	Parameter	Value	Unit
$P_D$	Power Dissipation	830	mW
	Derate Above $T_A = 25^\circ\text{C}$	6.6	mW/ $^\circ\text{C}$
$R_{\theta JA}$	Thermal Resistance, Junction-to-Ambient	150	$^\circ\text{C}/\text{W}$

2. PCB size: FR-4, 76 mm x 114 mm x 1.57 mm (3.0 inch x 4.5 inch x 0.062 inch) with minimum land pattern size.

### ELECTRICAL CHARACTERISTICS (Values are at $T_A = 25^\circ\text{C}$ unless otherwise noted.)

Symbol	Parameter	Conditions	Min	Typ	Max	Unit
$BV_{CBO}$	Collector-Base Breakdown Voltage	$I_C = 100\ \mu\text{A}, I_E = 0$	100	-	-	V
$BV_{CEO}$	Collector-Emitter Breakdown Voltage	$I_C = 10\ \text{mA}, I_B = 0$	80	-	-	V
$BV_{EBO}$	Emitter-Base Breakdown Voltage	$I_E = 10\ \mu\text{A}, I_C = 0$	5.0	-	-	V
$I_{CBO}$	Collector Cut-Off Current	$V_{CB} = 30\ \text{V}, I_E = 0$	-	-	100	nA
$I_{EBO}$	Emitter Cut-Off Current	$V_{EB} = 5\ \text{V}, I_C = 0$	-	-	10	$\mu\text{A}$
$h_{FE1}$	DC Current Gain	$V_{CE} = 2\ \text{V}, I_C = 5\ \text{mA}$	25	-	-	
$h_{FE2}$		$V_{CE} = 2\ \text{V}, I_C = 150\ \text{mA}$	100	-	250	
$h_{FE3}$		$V_{CE} = 2\ \text{V}, I_C = 500\ \text{mA}$	25	-	-	
$V_{CE(sat)}$	Collector-Emitter Saturation Voltage	$I_C = 500\ \text{mA}, I_B = 50\ \text{mA}$	-	-	0.5	V
$V_{BE(on)}$	Base-Emitter On Voltage	$V_{CE} = 2\ \text{V}, I_C = 500\ \text{mA}$	-	-	1	V
$f_T$	Current Gain Bandwidth Product	$V_{CE} = 5\ \text{V}, I_C = 10\ \text{mA}, f = 50\ \text{MHz}$	-	100	-	MHz

Product parametric performance is indicated in the Electrical Characteristics for the listed test conditions, unless otherwise noted. Product performance may not be indicated by the Electrical Characteristics if operated under different conditions.



Bent Lead

TO-92-3  
CASE 135AR

### MARKING DIAGRAM

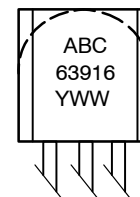

A = Assembly Location  
 BC63916 = Specific Device Code  
 Y = Year  
 WW = Work Week

### ORDERING INFORMATION

Device	Package	Shipping <sup>†</sup>
BC63916-D74Z	TO-92-3 (Pb-Free)	2000 / FNFLD
BC63916-D2TZ	TO-92-3 (Pb-Free)	2000 / Tape & Reel

<sup>†</sup>For information on tape and reel specifications, including part orientation and tape sizes, please refer to our Tape and Reel Packaging Specifications Brochure, [BRD8011/D](http://BRD8011/D).

**BC63916**

**TYPICAL PERFORMANCE CHARACTERISTICS**

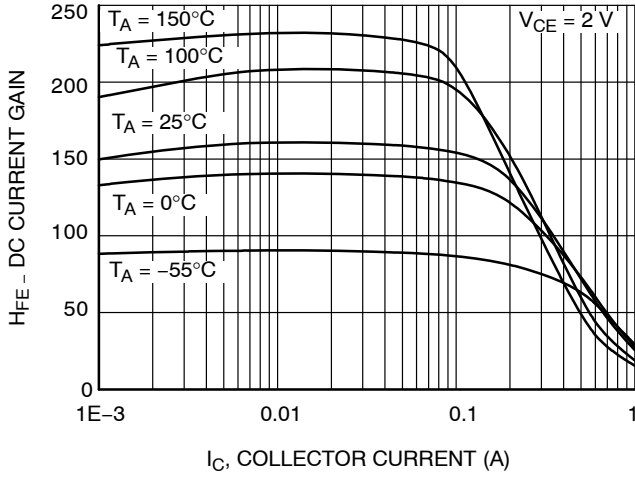

**Figure 1. DC Current Gain**

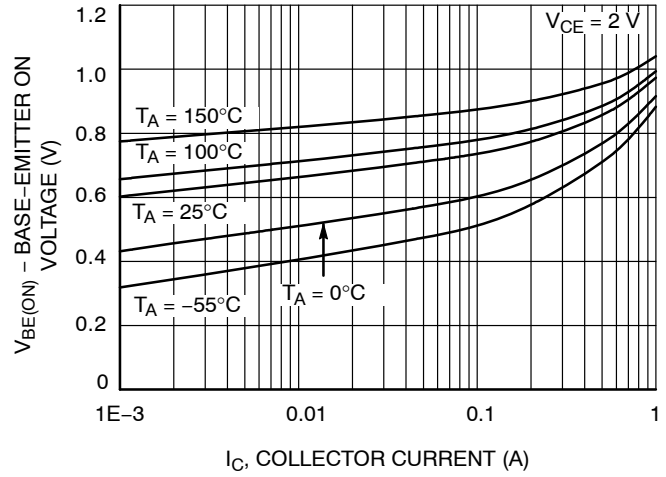

**Figure 2. Base-Emitter On Voltage**

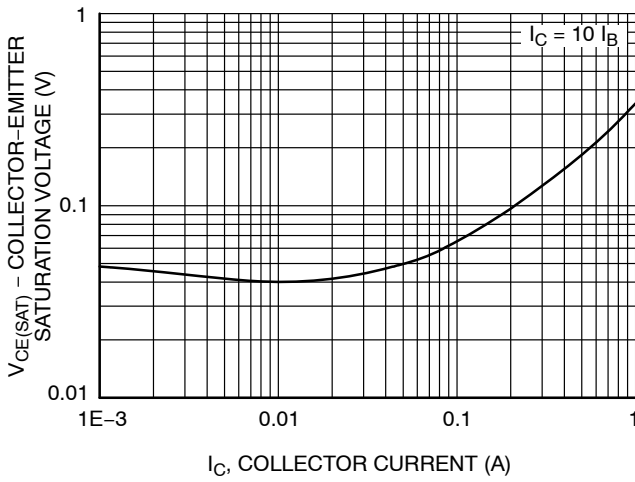

**Figure 3. Collector-Emitter Saturation Voltage**

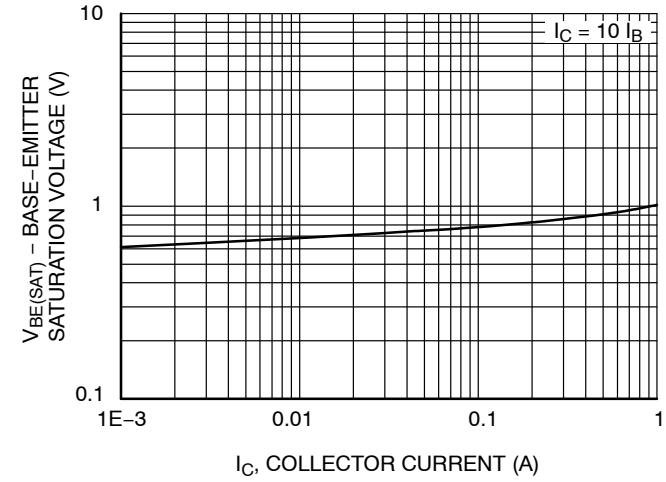

**Figure 4. Base-Emitter Saturation Voltage**

**TO-92 3 4.83x4.76 LEADFORMED**  
CASE 135AR  
ISSUE O

DATE 30 SEP 2016

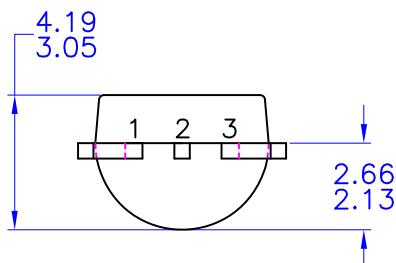
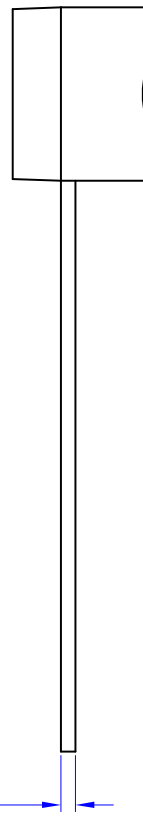
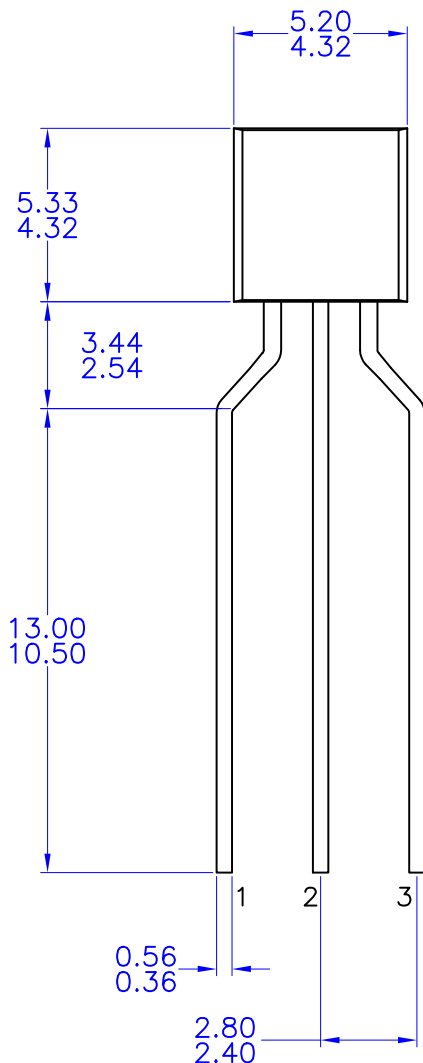

NOTES: UNLESS OTHERWISE SPECIFIED

- A) DRAWING WITH REFERENCE TO JEDEC TO-92 RECOMMENDATIONS.
- B) ALL DIMENSIONS ARE IN MILLIMETERS.
- C) DRAWING CONFORMS TO ASME Y14.5M-1994

<b>DOCUMENT NUMBER:</b>	<b>98AON13879G</b>	Electronic versions are uncontrolled except when accessed directly from the Document Repository. Printed versions are uncontrolled except when stamped "CONTROLLED COPY" in red.
<b>DESCRIPTION:</b>	<b>TO-92 3 4.83X4.76 LEADFORMED</b>	<b>PAGE 1 OF 1</b>

onsemi and ONSEMI are trademarks of Semiconductor Components Industries, LLC dba onsemi or its subsidiaries in the United States and/or other countries. onsemi reserves the right to make changes without further notice to any products herein. onsemi makes no warranty, representation or guarantee regarding the suitability of its products for any particular purpose, nor does onsemi assume any liability arising out of the application or use of any product or circuit, and specifically disclaims any and all liability, including without limitation special, consequential or incidental damages. onsemi does not convey any license under its patent rights nor the rights of others.

**onsemi**, **Onsemi**, and other names, marks, and brands are registered and/or common law trademarks of Semiconductor Components Industries, LLC dba "**onsemi**" or its affiliates and/or subsidiaries in the United States and/or other countries. **onsemi** owns the rights to a number of patents, trademarks, copyrights, trade secrets, and other intellectual property. A listing of **onsemi**'s product/patent coverage may be accessed at [www.onsemi.com/site/pdf/Patent-Marking.pdf](http://www.onsemi.com/site/pdf/Patent-Marking.pdf). **onsemi** reserves the right to make changes at any time to any products or information herein, without notice. The information herein is provided "as-is" and **onsemi** makes no warranty, representation or guarantee regarding the accuracy of the information, product features, availability, functionality, or suitability of its products for any particular purpose, nor does **onsemi** assume any liability arising out of the application or use of any product or circuit, and specifically disclaims any and all liability, including without limitation special, consequential or incidental damages. Buyer is responsible for its products and applications using **onsemi** products, including compliance with all laws, regulations and safety requirements or standards, regardless of any support or applications information provided by **onsemi**. "Typical" parameters which may be provided in **onsemi** data sheets and/or specifications can and do vary in different applications and actual performance may vary over time. All operating parameters, including "Typicals" must be validated for each customer application by customer's technical experts. **onsemi** does not convey any license under any of its intellectual property rights nor the rights of others. **onsemi** products are not designed, intended, or authorized for use as a critical component in life support systems or any FDA Class 3 medical devices or medical devices with a same or similar classification in a foreign jurisdiction or any devices intended for implantation in the human body. Should Buyer purchase or use **onsemi** products for any such unintended or unauthorized application, Buyer shall indemnify and hold **onsemi** and its officers, employees, subsidiaries, affiliates, and distributors harmless against all claims, costs, damages, and expenses, and reasonable attorney fees arising out of, directly or indirectly, any claim of personal injury or death associated with such unintended or unauthorized use, even if such claim alleges that **onsemi** was negligent regarding the design or manufacture of the part. **onsemi** is an Equal Opportunity/Affirmative Action Employer. This literature is subject to all applicable copyright laws and is not for resale in any manner.

#### ADDITIONAL INFORMATION

**TECHNICAL PUBLICATIONS:**

Technical Library: [www.onsemi.com/design/resources/technical-documentation](http://www.onsemi.com/design/resources/technical-documentation)  
onsemi Website: [www.onsemi.com](http://www.onsemi.com)

**ONLINE SUPPORT:** [www.onsemi.com/support](http://www.onsemi.com/support)

For additional information, please contact your local Sales Representative at [www.onsemi.com/support/sales](http://www.onsemi.com/support/sales)

## OUR CERTIFICATE

DiGi provide top-quality products and perfect service for customer worldwide through standardization, technological innovation and continuous improvement. DiGi through third-party certification, we stricly control the quality of products and services. Welcome your RFQ to

Email: [Info@DiGi-Electronics.com](mailto:Info@DiGi-Electronics.com)



Tel: +00 852-30501935

RFQ Email: [Info@DiGi-Electronics.com](mailto:Info@DiGi-Electronics.com)

DiGi is a global authorized distributor of electronic components.