

BC807-16LT3 Datasheet

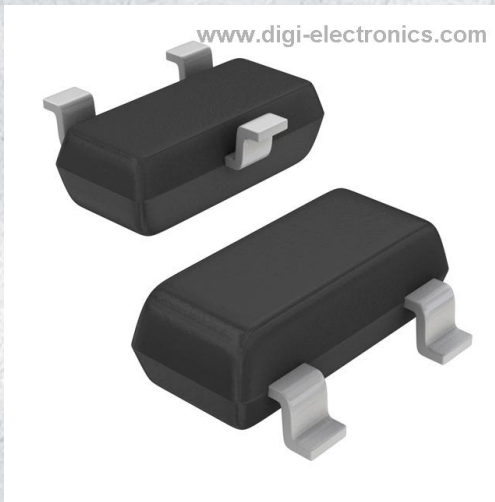

<https://www.DiGi-Electronics.com>

DiGi Electronics Part Number	BC807-16LT3-DG
Manufacturer	onsemi
Manufacturer Product Number	BC807-16LT3
Description	TRANS PNP 45V 0.5A SOT23-3
Detailed Description	Bipolar (BJT) Transistor PNP 45 V 500 mA 100MHz 300 mW Surface Mount SOT-23-3 (TO-236)



Tel: +00 852-30501935

RFQ Email: Info@DiGi-Electronics.com

DiGi is a global authorized distributor of electronic components.

Purchase and inquiry

Manufacturer Product Number:

BC807-16LT3

Series:

-

Transistor Type:

PNP

Voltage - Collector Emitter Breakdown (Max):

45 V

Current - Collector Cutoff (Max):

100nA (ICBO)

Power - Max:

300 mW

Operating Temperature:

-55°C ~ 150°C (TJ)

Package / Case:

TO-236-3, SC-59, SOT-23-3

Base Product Number:

BC807

Manufacturer:

onsemi

Product Status:

Obsolete

Current - Collector (Ic) (Max):

500 mA

Vce Saturation (Max) @ Ib, Ic:

700mV @ 50mA, 500mA

DC Current Gain (hFE) (Min) @ Ic, Vce:

100 @ 100mA, 1V

Frequency - Transition:

100MHz

Mounting Type:

Surface Mount

Supplier Device Package:

SOT-23-3 (TO-236)

Environmental & Export classification

RoHS Status:

RoHS non-compliant

REACH Status:

REACH Unaffected

HTSUS:

8541.21.0075

Moisture Sensitivity Level (MSL):

1 (Unlimited)

ECCN:

EAR99

BC807-16LT1, BC807-25LT1, BC807-40LT1

General Purpose Transistors

PNP Silicon

Features

- Pb-Free Packages are Available

MAXIMUM RATINGS

Rating	Symbol	Value	Unit
Collector – Emitter Voltage	V_{CEO}	-45	V
Collector – Base Voltage	V_{CBO}	-50	V
Emitter – Base Voltage	V_{EBO}	-5.0	V
Collector Current – Continuous	I_C	-500	mAdc

THERMAL CHARACTERISTICS

Characteristic	Symbol	Max	Unit
Total Device Dissipation FR-5 Board, (Note 1) $T_A = 25^\circ\text{C}$ Derate above 25°C	P_D	225 1.8	mW mW/ $^\circ\text{C}$
Thermal Resistance, Junction-to-Ambient	$R_{\theta JA}$	556	$^\circ\text{C}/\text{W}$
Total Device Dissipation Alumina Substrate, (Note 2) $T_A = 25^\circ\text{C}$ Derate above 25°C	P_D	300 2.4	mW mW/ $^\circ\text{C}$
Thermal Resistance, Junction-to-Ambient	$R_{\theta JA}$	417	$^\circ\text{C}/\text{W}$
Junction and Storage Temperature	T_J, T_{stg}	-55 to +150	$^\circ\text{C}$

Maximum ratings are those values beyond which device damage can occur. Maximum ratings applied to the device are individual stress limit values (not normal operating conditions) and are not valid simultaneously. If these limits are exceeded, device functional operation is not implied, damage may occur and reliability may be affected.

- FR-5 = 1.0 x 0.75 x 0.062 in.
- Alumina = 0.4 x 0.3 x 0.024 in 99.5% alumina.



ON Semiconductor®

<http://onsemi.com>

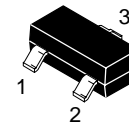
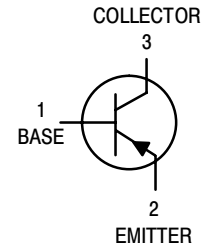

SOT-23
CASE 318
STYLE 6

MARKING DIAGRAM

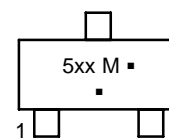

5xx = Device Code
xx = A1, B1, or C
M = Date Code*
■ = Pb-Free Package

(Note: Microdot may be in either location)

*Date Code orientation and/or overbar may vary depending upon manufacturing location.

ORDERING INFORMATION

See detailed ordering and shipping information in the package dimensions section on page 2 of this data sheet.

BC807-16LT1, BC807-25LT1, BC807-40LT1**ELECTRICAL CHARACTERISTICS** ($T_A = 25^\circ\text{C}$ unless otherwise noted.)

Characteristic	Symbol	Min	Typ	Max	Unit	
OFF CHARACTERISTICS						
Collector–Emitter Breakdown Voltage ($I_C = -10\text{ mA}$)	$V_{(BR)CEO}$	-45	–	–	V	
Collector–Emitter Breakdown Voltage ($V_{EB} = 0, I_C = -10\ \mu\text{A}$)	$V_{(BR)CES}$	-50	–	–	V	
Emitter–Base Breakdown Voltage ($I_E = -1.0\ \mu\text{A}$)	$V_{(BR)EBO}$	-5.0	–	–	V	
Collector Cutoff Current ($V_{CB} = -20\text{ V}$) ($V_{CB} = -20\text{ V}, T_J = 150^\circ\text{C}$)	I_{CBO}	–	–	-100 -5.0	nA μA	
ON CHARACTERISTICS						
DC Current Gain ($I_C = -100\text{ mA}, V_{CE} = -1.0\text{ V}$)	h_{FE}	100	–	250	–	
($I_C = -500\text{ mA}, V_{CE} = -1.0\text{ V}$)		BC807-16	160	–	400	
		BC807-25 BC807-40	250 40	–	600 –	
Collector–Emitter Saturation Voltage ($I_C = -500\text{ mA}, I_B = -50\text{ mA}$)	$V_{CE(sat)}$	–	–	-0.7	V	
Base–Emitter On Voltage ($I_C = -500\text{ mA}, I_B = -1.0\text{ V}$)	$V_{BE(on)}$	–	–	-1.2	V	
SMALL-SIGNAL CHARACTERISTICS						
Current–Gain – Bandwidth Product ($I_C = -10\text{ mA}, V_{CE} = -5.0\text{ Vdc}, f = 100\text{ MHz}$)	f_T	100	–	–	MHz	
Output Capacitance ($V_{CB} = -10\text{ V}, f = 1.0\text{ MHz}$)	C_{obo}	–	10	-0.7	pF	

ORDERING INFORMATION

Device	Specific Marking	Package	Shipping†
BC807-16LT1	5A1	SOT-23	3000/Tape & Reel
BC807-16LT1G		SOT-23 (Pb-Free)	3000/Tape & Reel
BC807-16LT3		SOT-23	10,000/Tape & Reel
BC807-16LT3G		SOT-23 (Pb-Free)	10,000/Tape & Reel
BC807-25LT1	5B1	SOT-23	3000/Tape & Reel
BC807-25LT1G		SOT-23 (Pb-Free)	3000/Tape & Reel
BC807-25LT3		SOT-23	10,000/Tape & Reel
BC807-25LT3G		SOT-23 (Pb-Free)	10,000/Tape & Reel
BC807-40LT1	5C	SOT-23	3000/Tape & Reel
BC807-40LT1G		SOT-23 (Pb-Free)	3000/Tape & Reel
BC807-40LT3		SOT-23	10,000/Tape & Reel
BC807-40LT3G		SOT-23 (Pb-Free)	10,000/Tape & Reel

†For information on tape and reel specifications, including part orientation and tape sizes, please refer to our Tape and Reel Packaging Specifications Brochure, BRD8011/D.

BC807-16LT1, BC807-25LT1, BC807-40LT1

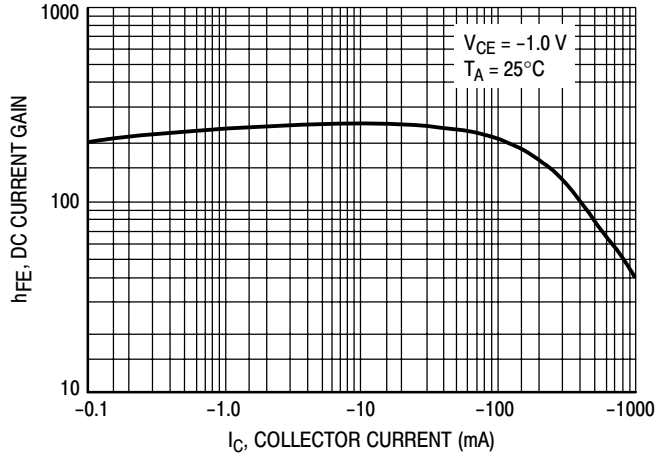

Figure 1. DC Current Gain

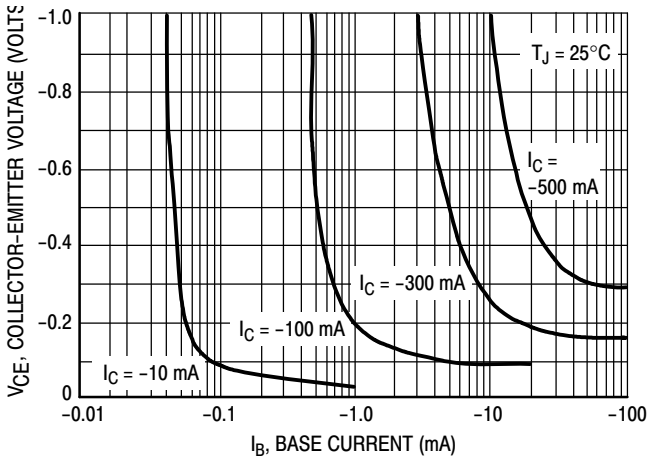

Figure 2. Saturation Region

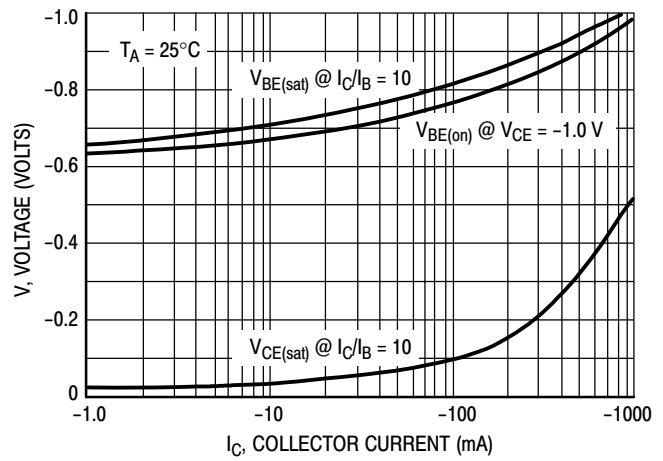

Figure 3. "On" Voltages

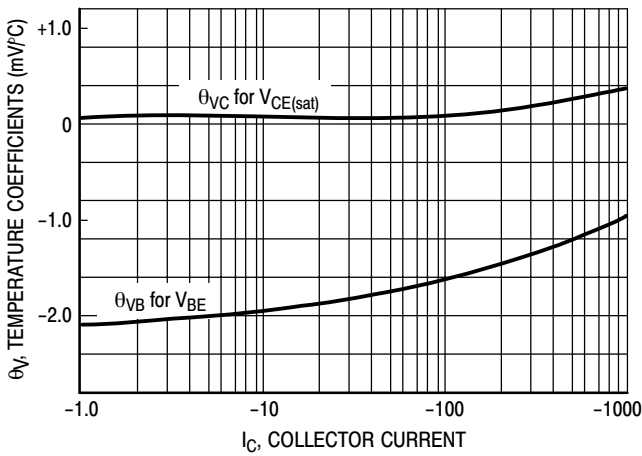

Figure 4. Temperature Coefficients

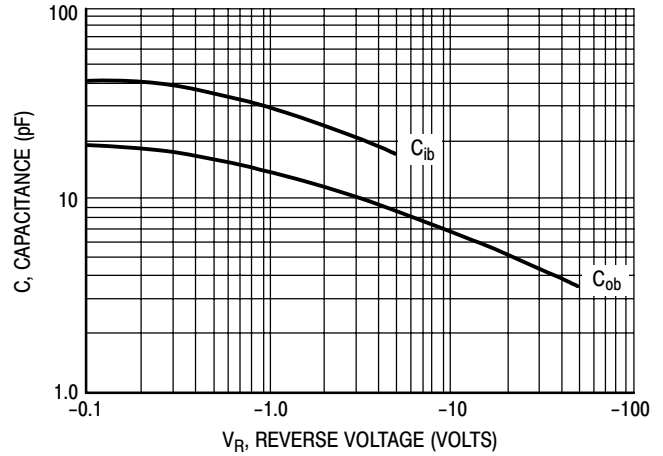
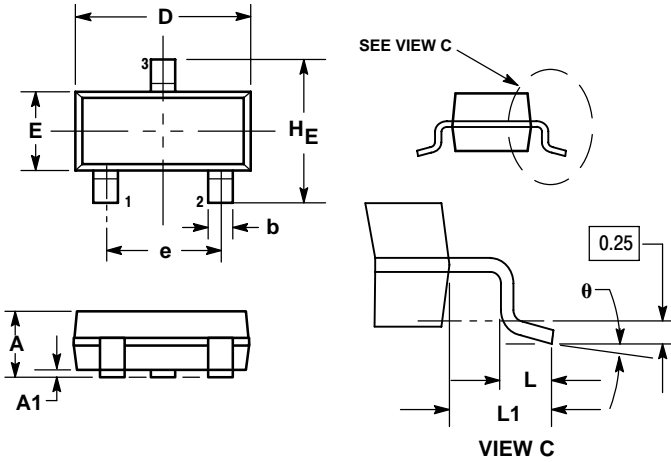

Figure 5. Capacitances

BC807-16LT1, BC807-25LT1, BC807-40LT1

PACKAGE DIMENSIONS

**SOT-23 (TO-236)
CASE 318-08
ISSUE AN**



- NOTES:
1. DIMENSIONING AND TOLERANCING PER ANSI Y14.5M, 1982.
 2. CONTROLLING DIMENSION: INCH.
 3. MAXIMUM LEAD THICKNESS INCLUDES LEAD FINISH THICKNESS. MINIMUM LEAD THICKNESS IS THE MINIMUM THICKNESS OF BASE MATERIAL.
 4. 318-01 THRU -07 AND -09 OBSOLETE, NEW STANDARD 318-08.

DIM	MILLIMETERS			INCHES		
	MIN	NOM	MAX	MIN	NOM	MAX
A	0.89	1.00	1.11	0.035	0.040	0.044
A1	0.01	0.06	0.10	0.001	0.002	0.004
b	0.37	0.44	0.50	0.015	0.018	0.020
c	0.09	0.13	0.18	0.003	0.005	0.007
D	2.80	2.90	3.04	0.110	0.114	0.120
E	1.20	1.30	1.40	0.047	0.051	0.055
e	1.78	1.90	2.04	0.070	0.075	0.081
L	0.10	0.20	0.30	0.004	0.008	0.012
L1	0.35	0.54	0.69	0.014	0.021	0.029
HE	2.10	2.40	2.64	0.083	0.094	0.104

- STYLE 6:
PIN 1. BASE
2. EMITTER
3. COLLECTOR

SOLDERING FOOTPRINT*

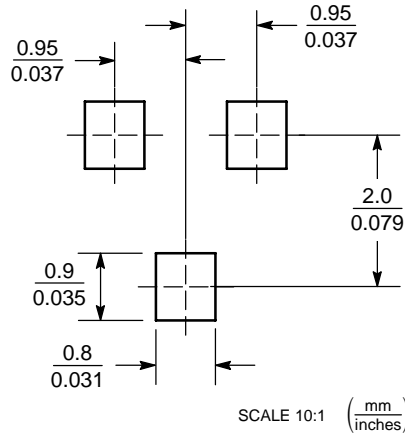

*For additional information on our Pb-Free strategy and soldering details, please download the ON Semiconductor Soldering and Mounting Techniques Reference Manual, SOLDERRM/D.

ON Semiconductor and are registered trademarks of Semiconductor Components Industries, LLC (SCILLC). SCILLC reserves the right to make changes without further notice to any products herein. SCILLC makes no warranty, representation or guarantee regarding the suitability of its products for any particular purpose, nor does SCILLC assume any liability arising out of the application or use of any product or circuit, and specifically disclaims any and all liability, including without limitation special, consequential or incidental damages. "Typical" parameters which may be provided in SCILLC data sheets and/or specifications can and do vary in different applications and actual performance may vary over time. All operating parameters, including "Typicals" must be validated for each customer application by customer's technical experts. SCILLC does not convey any license under its patent rights nor the rights of others. SCILLC products are not designed, intended, or authorized for use as components in systems intended for surgical implant into the body, or other applications intended to support or sustain life, or for any other application in which the failure of the SCILLC product could create a situation where personal injury or death may occur. Should Buyer purchase or use SCILLC products for any such unintended or unauthorized application, Buyer shall indemnify and hold SCILLC and its officers, employees, subsidiaries, affiliates, and distributors harmless against all claims, costs, damages, and expenses, and reasonable attorney fees arising out of, directly or indirectly, any claim of personal injury or death associated with such unintended or unauthorized use, even if such claim alleges that SCILLC was negligent regarding the design or manufacture of the part. SCILLC is an Equal Opportunity/Affirmative Action Employer. This literature is subject to all applicable copyright laws and is not for resale in any manner.

PUBLICATION ORDERING INFORMATION

LITERATURE FULFILLMENT:
Literature Distribution Center for ON Semiconductor
P.O. Box 61312, Phoenix, Arizona 85082-1312 USA
Phone: 480-829-7710 or 800-344-3860 Toll Free USA/Canada
Fax: 480-829-7709 or 800-344-3867 Toll Free USA/Canada
Email: orderlit@onsemi.com

N. American Technical Support: 800-282-9855 Toll Free USA/Canada
Japan: ON Semiconductor, Japan Customer Focus Center
2-9-1 Kamimeguro, Meguro-ku, Tokyo, Japan 153-0051
Phone: 81-3-5773-3850

ON Semiconductor Website: <http://onsemi.com>
Order Literature: <http://www.onsemi.com/litorder>
For additional information, please contact your local Sales Representative.

OUR CERTIFICATE

DiGi provide top-quality products and perfect service for customer worldwide through standardization, technological innovation and continuous improvement. DiGi through third-party certification, we strictly control the quality of products and services. Welcome your RFQ to

Email: Info@DiGi-Electronics.com



Tel: +00 852-30501935

RFQ Email: Info@DiGi-Electronics.com

DiGi is a global authorized distributor of electronic components.