

BUB323ZT4 Datasheet

www.digi-electronics.com



<https://www.DiGi-Electronics.com>

| | |
|------------------------------|---|
| DiGi Electronics Part Number | BUB323ZT4-DG |
| Manufacturer | onsemi |
| Manufacturer Product Number | BUB323ZT4 |
| Description | TRANS NPN DARL 350V 10A D2PAK |
| Detailed Description | Bipolar (BJT) Transistor NPN - Darlington 350 V 10 A 2MHz 150 W Surface Mount D2PAK |



Tel: +00 852-30501935

RFQ Email: Info@DiGi-Electronics.com

DiGi is a global authorized distributor of electronic components.

Purchase and inquiry

Manufacturer Product Number:

BUB323ZT4

Series:

-

Transistor Type:

NPN - Darlington

Voltage - Collector Emitter Breakdown (Max):

350 V

Current - Collector Cutoff (Max):

100 μ A

Power - Max:

150 W

Operating Temperature:

-65°C ~ 175°C (TJ)

Package / Case:

TO-263-3, D2PAK (2 Leads + Tab), TO-263AB

Base Product Number:

BUB323

Manufacturer:

onsemi

Product Status:

Obsolete

Current - Collector (Ic) (Max):

10 A

Vce Saturation (Max) @ Ib, Ic:

1.7V @ 250mA, 10A

DC Current Gain (hFE) (Min) @ Ic, Vce:

500 @ 5A, 4.6V

Frequency - Transition:

2MHz

Mounting Type:

Surface Mount

Supplier Device Package:

D2PAK

Environmental & Export classification

RoHS Status:

RoHS non-compliant

REACH Status:

REACH Unaffected

HTSUS:

8541.29.0095

Moisture Sensitivity Level (MSL):

1 (Unlimited)

ECCN:

EAR99

NPN Silicon Power Darlington

High Voltage Autoprotected D²PAK for Surface Mount

BUB323Z

The BUB323Z is a planar, monolithic, high-voltage power Darlington with a built-in active zener clamping circuit. This device is specifically designed for unclamped, inductive applications such as Electronic Ignition, Switching Regulators and Motor Control.

Features

- Integrated High-Voltage Active Clamp
- Tight Clamping Voltage Window (350 V to 450 V) Guaranteed Over the -40°C to +125°C Temperature Range
- Clamping Energy Capability 100% Tested in a Live Ignition Circuit
- High DC Current Gain/Low Saturation Voltages Specified Over Full Temperature Range
- Design Guarantees Operation in SOA at All Times
- NJV Prefix for Automotive and Other Applications Requiring Unique Site and Control Change Requirements; AEC-Q101 Qualified and PPAP Capable
- These Devices are Pb-Free, Halogen Free/BFR Free and are RoHS Compliant

MAXIMUM RATINGS

| Rating | Symbol | Value | Unit |
|--|----------------|-------------|-----------|
| Collector-Emitter Sustaining Voltage | V_{CEO} | 350 | Vdc |
| Collector-Emitter Voltage | V_{EBO} | 6.0 | Vdc |
| Collector Current – Continuous | I_C | 10 | Adc |
| – Peak | I_{CM} | 20 | |
| Base Current – Continuous | I_B | 3.0 | Adc |
| – Peak | I_{BM} | 6.0 | |
| Total Power Dissipation @ $T_C = 25^\circ\text{C}$ Derate above 25°C | P_D | 150 1.0 | W W/°C |
| Operating and Storage Junction Temperature Range | T_J, T_{stg} | -65 to +175 | °C |

THERMAL CHARACTERISTICS

| Characteristic | Symbol | Max | Unit |
|---|-----------------|------|------|
| Thermal Resistance, Junction-to-Case | $R_{\theta JC}$ | 1.0 | °C/W |
| Thermal Resistance, Junction-to-Ambient | $R_{\theta JA}$ | 62.5 | °C/W |
| Maximum Lead Temperature for Soldering Purposes, 1/8 in from Case for 5 Seconds | T_L | 260 | °C |

Stresses exceeding those listed in the Maximum Ratings table may damage the device. If any of these limits are exceeded, device functionality should not be assumed, damage may occur and reliability may be affected.

**AUTOPROTECTED
DARLINGTON
10 AMPERES
360–450 VOLTS CLAMP
150 WATTS**

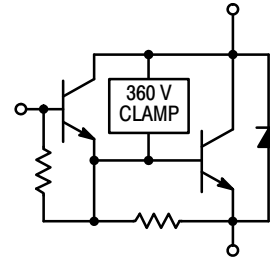

MARKING DIAGRAM

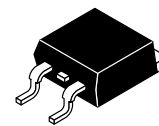

**D²PAK
CASE 418B
STYLE 1**

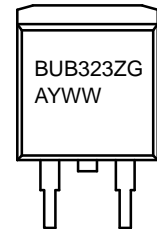

BUB323Z = Specific Device Code
 A = Assembly Location
 Y = Year
 WW = Work Week
 G = Pb-Free Package

ORDERING INFORMATION

See detailed ordering and shipping information in the package dimensions section on page 6 of this data sheet.

NOTE: Some of the devices on this data sheet have been **DISCONTINUED**. Please refer to the table on page 6.

BUB323Z**ELECTRICAL CHARACTERISTICS** ($T_C = 25^\circ\text{C}$ unless otherwise noted)

| Characteristic | Symbol | Min | Typ | Max | Unit |
|--|--------------------|-----|-----|-----|-----------------|
| OFF CHARACTERISTICS (Note 1) | | | | | |
| Collector–Emitter Clamping Voltage ($I_C = 7.0\text{ A}$) ($T_C = -40^\circ\text{C}$ to $+125^\circ\text{C}$) | V_{CLAMP} | 350 | – | 450 | Vdc |
| Collector–Emitter Cutoff Current ($V_{\text{CE}} = 200\text{ V}$, $I_B = 0$) | I_{CEO} | – | – | 100 | μAdc |
| Emitter–Base Leakage Current ($V_{\text{EB}} = 6.0\text{ Vdc}$, $I_C = 0$) | I_{EBO} | – | – | 50 | mAdc |

ON CHARACTERISTICS (Note 1)

| | | | | | |
|---|----------------------|-------------|-------------|---------------------------------|-----|
| Base–Emitter Saturation Voltage ($I_C = 8.0\text{ Adc}$, $I_B = 100\text{ mAdc}$) ($I_C = 10\text{ Adc}$, $I_B = 0.25\text{ Adc}$) | $V_{\text{BE(sat)}}$ | – – | – – | 2.2 2.5 | Vdc |
| Collector–Emitter Saturation Voltage ($I_C = 7.0\text{ Adc}$, $I_B = 70\text{ mAdc}$) ($I_C = 8.0\text{ Adc}$, $I_B = 0.1\text{ Adc}$) ($I_C = 10\text{ Adc}$, $I_B = 0.25\text{ Adc}$) | $V_{\text{CE(sat)}}$ | – – – | – – – | 1.6 1.8 1.8 2.1 1.7 | Vdc |
| Base–Emitter On Voltage ($I_C = 5.0\text{ Adc}$, $V_{\text{CE}} = 2.0\text{ Vdc}$) ($I_C = 8.0\text{ Adc}$, $V_{\text{CE}} = 2.0\text{ Vdc}$) | $V_{\text{BE(on)}}$ | 1.1 1.3 | – – | 2.1 2.3 | Vdc |
| Diode Forward Voltage Drop ($I_F = 10\text{ Adc}$) | V_F | – | – | 2.5 | Vdc |
| DC Current Gain ($I_C = 6.5\text{ Adc}$, $V_{\text{CE}} = 1.5\text{ Vdc}$) ($I_C = 5.0\text{ Adc}$, $V_{\text{CE}} = 4.6\text{ Vdc}$) | h_{FE} | 150 500 | – – | – 3400 | – |

DYNAMIC CHARACTERISTICS

| | | | | | |
|---|-----------------|---|---|-----|-----|
| Current Gain Bandwidth ($I_C = 0.2\text{ Adc}$, $V_{\text{CE}} = 10\text{ Vdc}$, $f = 1.0\text{ MHz}$) | f_T | – | – | 2.0 | MHz |
| Output Capacitance ($V_{\text{CB}} = 10\text{ Vdc}$, $I_E = 0$, $f = 1.0\text{ MHz}$) | C_{ob} | – | – | 200 | pF |
| Input Capacitance ($V_{\text{EB}} = 6.0\text{ V}$) | C_{ib} | – | – | 550 | pF |

CLAMPING ENERGY (See Notes)

| | | | | | |
|---|--------------------|-----|---|---|----|
| Repetitive Non–Destructive Energy Dissipated at turn–off: ($I_C = 7.0\text{ A}$, $L = 8.0\text{ mH}$, $R_{\text{BE}} = 100\ \Omega$) (see Figures 2 and 4) | W_{CLAMP} | 200 | – | – | mJ |
|---|--------------------|-----|---|---|----|

SWITCHING CHARACTERISTICS: Inductive Load ($L = 10\text{ mH}$)

| | | | | | | |
|-----------------|---|-----------------|---|-----|----|---------------|
| Fall Time | $(I_C = 6.5\text{ A}$, $I_{\text{B1}} = 45\text{ mA}$, $V_{\text{BE(off)}} = 0$, $R_{\text{BE(off)}} = 0$, $V_{\text{CC}} = 14\text{ V}$, $V_Z = 300\text{ V}$) | t_{fi} | – | 625 | – | ns |
| Storage Time | | t_{si} | – | 10 | 30 | μs |
| Cross–over Time | | t_c | – | 1.7 | – | μs |

Product parametric performance is indicated in the Electrical Characteristics for the listed test conditions, unless otherwise noted. Product performance may not be indicated by the Electrical Characteristics if operated under different conditions.

1. Pulse Test: Pulse Width $\leq 300\ \mu\text{s}$, Duty Cycle = 2.0%.

BUB323Z

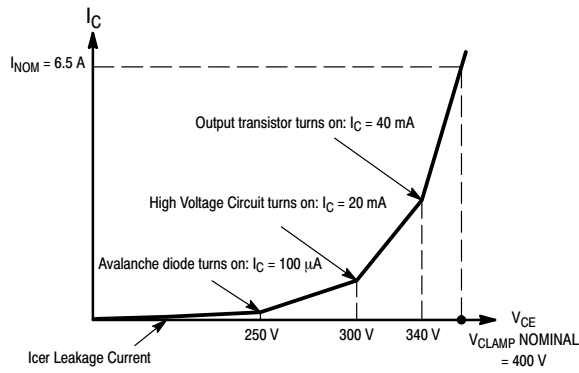

Figure 1. $I_C = f(V_{CE})$ Curve Shape

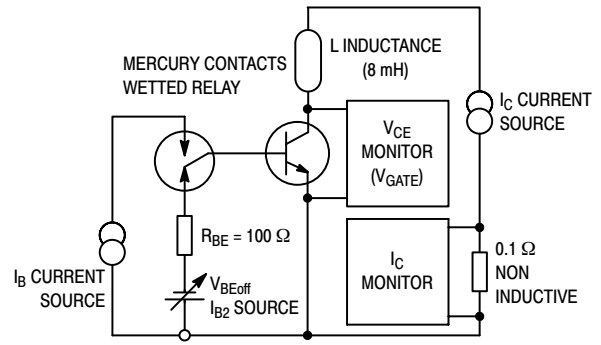

Figure 2. Basic Energy Test Circuit

By design, the BU323Z has a built-in avalanche diode and a special high voltage driving circuit. During an auto-protect cycle, the transistor is turned on again as soon as a voltage, determined by the zener threshold and the network, is reached. This prevents the transistor from going into a Reverse Bias Operating limit condition. Therefore, the device will have an extended safe operating area and will always appear to be in "FBSOA." Because of the built-in zener and associated network, the $I_C = f(V_{CE})$ curve exhibits an unfamiliar shape compared to standard products as shown in Figure 1.

The bias parameters, V_{CLAMP} , I_{B1} , $V_{BE(off)}$, I_{B2} , I_C , and the inductance, are applied according to the Device Under Test (DUT) specifications. V_{CE} and I_C are monitored by the test system while making sure the load line remains within the limits as described in Figure 4.

Note: All BU323Z ignition devices are 100% energy tested, per the test circuit and criteria described in Figures 2 and 4, to the minimum guaranteed repetitive energy, as specified in the device parameter section. The device can sustain this energy on a repetitive basis without degrading any of the specified electrical characteristics of the devices. The units under test are kept functional during the complete test sequence for the test conditions described:

$I_{C(peak)} = 7.0 \text{ A}$, $I_{CH} = 5.0 \text{ A}$, $I_{CL} = 100 \text{ mA}$, $I_B = 100 \text{ mA}$, $R_{BE} = 100 \text{ Ohms}$, $V_{gate} = 280 \text{ V}$, $L = 8.0 \text{ mH}$

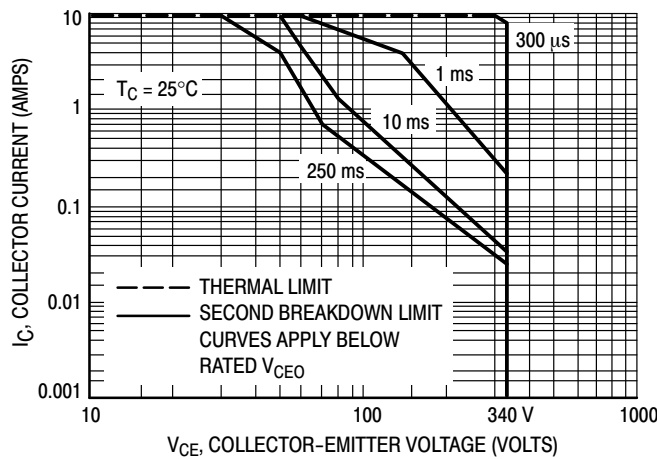
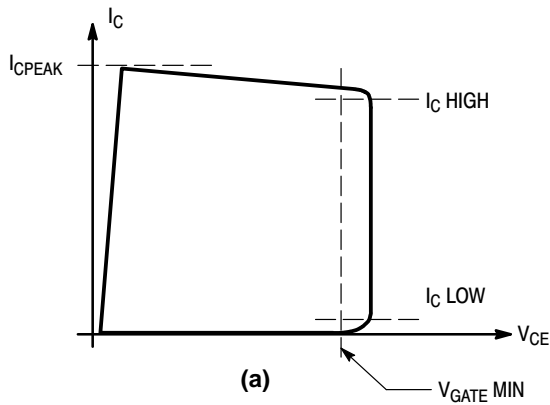
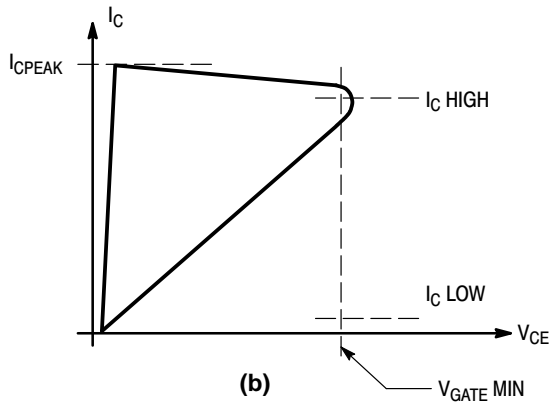

Figure 3. Forward Bias Safe Operating Area

BUB323Z

The shaded area represents the amount of energy the device can sustain, under given DC biases ($I_C/I_B/V_{BE(off)}/R_{BE}$), without an external clamp; see the test schematic diagram, Figure 2.

The transistor **PASSES** the Energy test if, for the inductive load and $I_{CPEAK}/I_B/V_{BE(off)}$ biases, the V_{CE} remains outside the shaded area and greater than the V_{GATE} minimum limit, Figure 4a.



The transistor **FAILS** if the V_{CE} is less than the V_{GATE} (minimum limit) at any point along the V_{CE}/I_C curve as shown on Figures 4b, and 4c. This assures that hot spots and uncontrolled avalanche are not being generated in the die, and the transistor is not damaged, thus enabling the sustained energy level required.

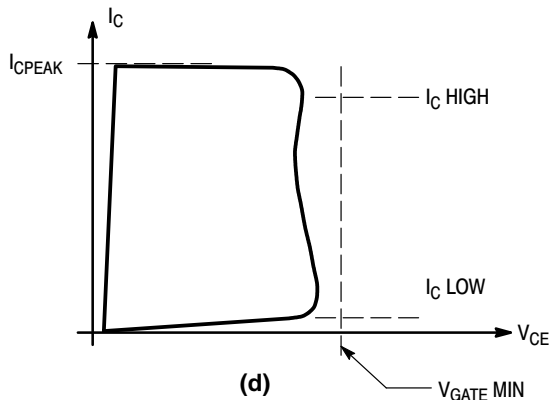
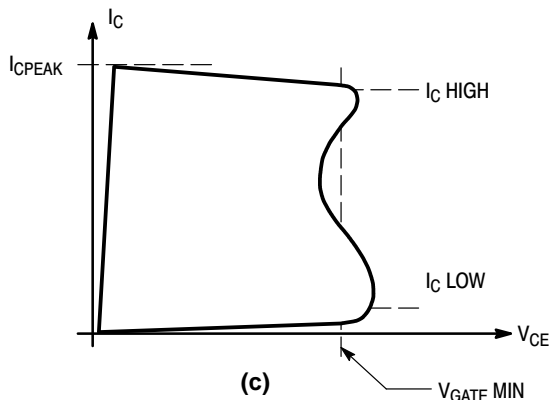

The transistor **FAILS** if its Collector/Emitter breakdown voltage is less than the V_{GATE} value, Figure 4d.

Figure 4. Energy Test Criteria for BU323Z

BUB323Z

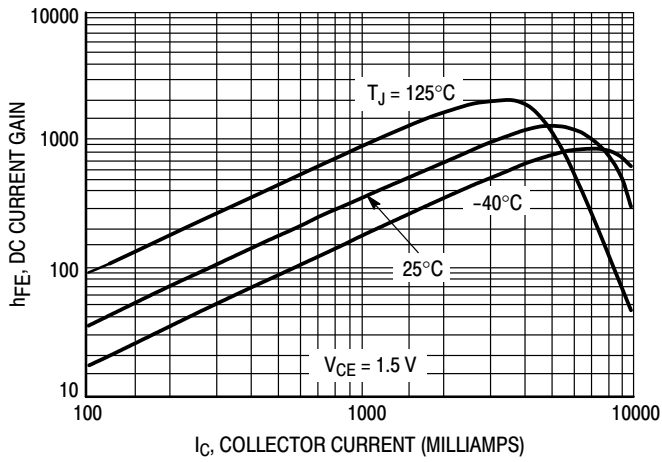

Figure 5. DC Current Gain

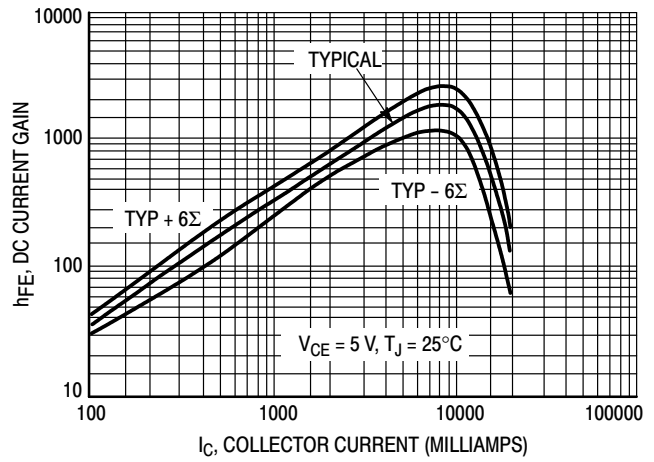

Figure 6. DC Current Gain

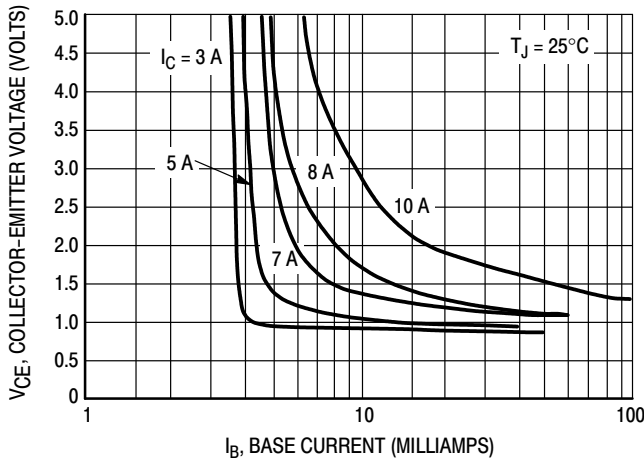

Figure 7. Collector Saturation Region

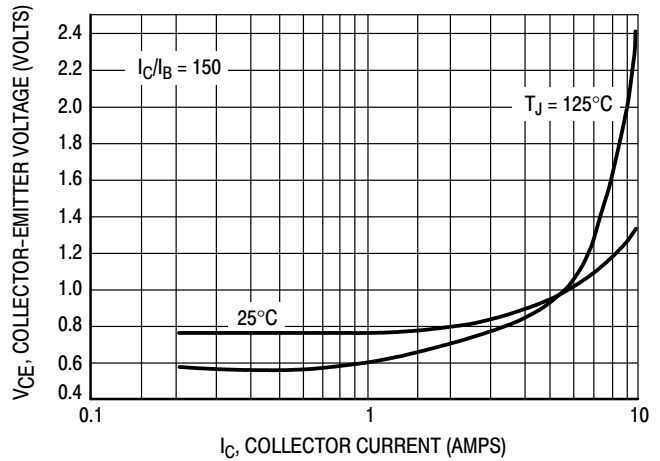

Figure 8. Collector-Emitter Saturation Voltage

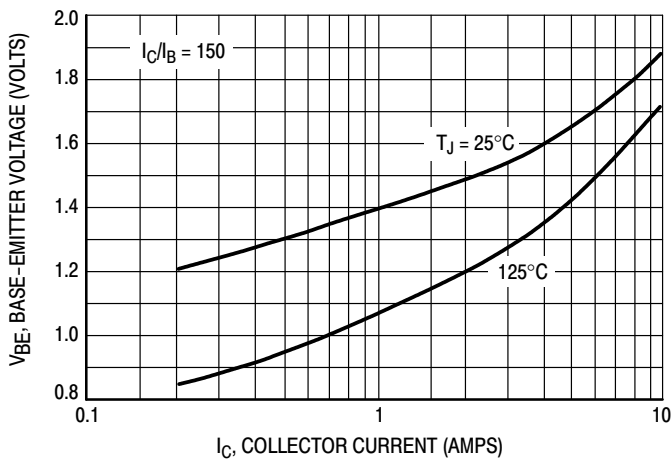

Figure 9. Base-Emitter Saturation Voltage

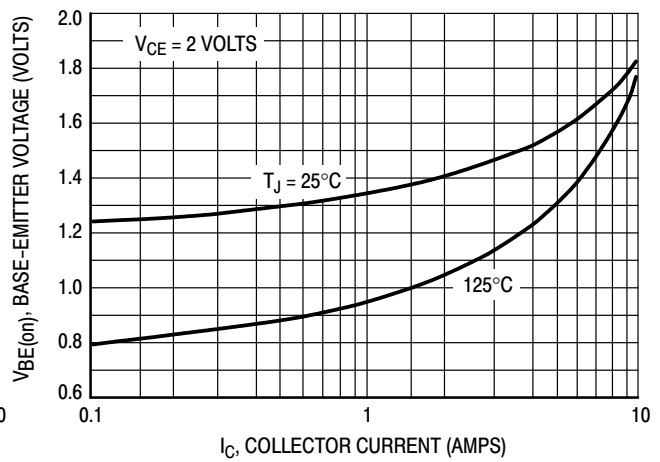

Figure 10. Base-Emitter "ON" Voltages

BUB323Z**ORDERING INFORMATION**

| Device | Package | Shipping† |
|------------|---------------------------------|-------------------------|
| BUB323ZT4G | D ² PAK (Pb-Free) | 800 Units / Tape & Reel |

DISCONTINUED (Note 2)

| | | |
|----------------|---------------------------------|-------------------------|
| BUB323ZG | D ² PAK (Pb-Free) | 50 Units / Rail |
| NJVBUB323ZT4G* | D ² PAK (Pb-Free) | 800 Units / Tape & Reel |

†For information on tape and reel specifications, including part orientation and tape sizes, please refer to our Tape and Reel Packaging Specifications Brochure, BRD8011/D.

*NJV Prefix for Automotive and Other Applications Requiring Unique Site and Control Change Requirements; AEC-Q101 Qualified and PPAP Capable.

2. **DISCONTINUED:** These devices are not recommended for new design. Please contact your **onsemi** representative for information. The most current information on these devices may be available on www.onsemi.com.



**MECHANICAL CASE OUTLINE
PACKAGE DIMENSIONS**



D²PAK 3
CASE 418B-04
ISSUE L

DATE 17 FEB 2015

SCALE 1:1

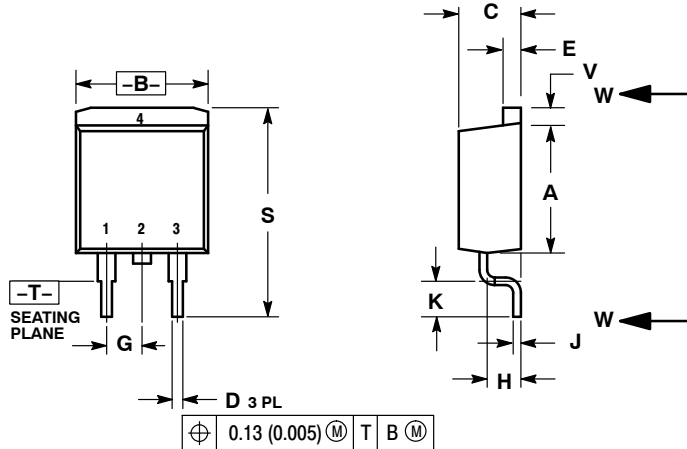

- NOTES:
1. DIMENSIONING AND TOLERANCING PER ANSI Y14.5M, 1982.
 2. CONTROLLING DIMENSION: INCH.
 3. 418B-01 THRU 418B-03 OBSOLETE, NEW STANDARD 418B-04.

| DIM | INCHES | | MILLIMETERS | |
|-----|--------|-------|-------------|-------|
| | MIN | MAX | MIN | MAX |
| A | 0.340 | 0.380 | 8.64 | 9.65 |
| B | 0.380 | 0.405 | 9.65 | 10.29 |
| C | 0.160 | 0.190 | 4.06 | 4.83 |
| D | 0.020 | 0.035 | 0.51 | 0.89 |
| E | 0.045 | 0.055 | 1.14 | 1.40 |
| F | 0.310 | 0.350 | 7.87 | 8.89 |
| G | 0.100 | BSC | 2.54 | BSC |
| H | 0.080 | 0.110 | 2.03 | 2.79 |
| J | 0.018 | 0.025 | 0.46 | 0.64 |
| K | 0.090 | 0.110 | 2.29 | 2.79 |
| L | 0.052 | 0.072 | 1.32 | 1.83 |
| M | 0.280 | 0.320 | 7.11 | 8.13 |
| N | 0.197 | REF | 5.00 | REF |
| P | 0.079 | REF | 2.00 | REF |
| R | 0.039 | REF | 0.99 | REF |
| S | 0.575 | 0.625 | 14.60 | 15.88 |
| V | 0.045 | 0.055 | 1.14 | 1.40 |

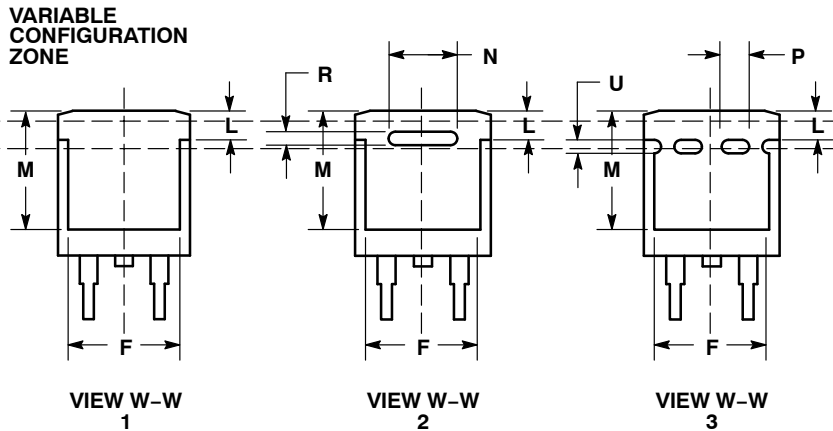

- | | | | | | |
|---|--|--|---|--|---|
| STYLE 1: PIN 1. BASE 2. COLLECTOR 3. EMITTER 4. COLLECTOR | STYLE 2: PIN 1. GATE 2. DRAIN 3. SOURCE 4. DRAIN | STYLE 3: PIN 1. ANODE 2. CATHODE 3. ANODE 4. CATHODE | STYLE 4: PIN 1. GATE 2. COLLECTOR 3. EMITTER 4. COLLECTOR | STYLE 5: PIN 1. CATHODE 2. ANODE 3. CATHODE 4. ANODE | STYLE 6: PIN 1. NO CONNECT 2. CATHODE 3. ANODE 4. CATHODE |
|---|--|--|---|--|---|

MARKING INFORMATION AND FOOTPRINT ON PAGE 2

| | | |
|-------------------------|---------------------------|---|
| DOCUMENT NUMBER: | 98ASB42761B | Electronic versions are uncontrolled except when accessed directly from the Document Repository. Printed versions are uncontrolled except when stamped "CONTROLLED COPY" in red. |
| DESCRIPTION: | D²PAK 3 | PAGE 1 OF 2 |

onsemi and ONSEMI are trademarks of Semiconductor Components Industries, LLC dba onsemi or its subsidiaries in the United States and/or other countries. onsemi reserves the right to make changes without further notice to any products herein. onsemi makes no warranty, representation or guarantee regarding the suitability of its products for any particular purpose, nor does onsemi assume any liability arising out of the application or use of any product or circuit, and specifically disclaims any and all liability, including without limitation special, consequential or incidental damages. onsemi does not convey any license under its patent rights nor the rights of others.

D²PAK 3
 CASE 418B-04
 ISSUE L

DATE 17 FEB 2015

**GENERIC
 MARKING DIAGRAM***

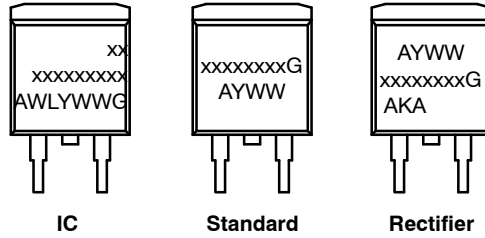

- xx = Specific Device Code
- A = Assembly Location
- WL = Wafer Lot
- Y = Year
- WW = Work Week
- G = Pb-Free Package
- AKA = Polarity Indicator

*This information is generic. Please refer to device data sheet for actual part marking. Pb-Free indicator, "G" or microdot "•", may or may not be present. Some products may not follow the Generic Marking.

SOLDERING FOOTPRINT*

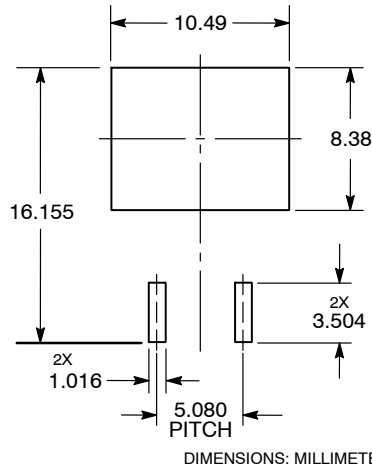

DIMENSIONS: MILLIMETERS

*For additional information on our Pb-Free strategy and soldering details, please download the **onsemi** Soldering and Mounting Techniques Reference Manual, SOLDERRM/D.

| | | |
|-------------------------|---------------------------|---|
| DOCUMENT NUMBER: | 98ASB42761B | Electronic versions are uncontrolled except when accessed directly from the Document Repository. Printed versions are uncontrolled except when stamped "CONTROLLED COPY" in red. |
| DESCRIPTION: | D²PAK 3 | PAGE 2 OF 2 |

onsemi and **ONSEMI** are trademarks of Semiconductor Components Industries, LLC dba **onsemi** or its subsidiaries in the United States and/or other countries. **onsemi** reserves the right to make changes without further notice to any products herein. **onsemi** makes no warranty, representation or guarantee regarding the suitability of its products for any particular purpose, nor does **onsemi** assume any liability arising out of the application or use of any product or circuit, and specifically disclaims any and all liability, including without limitation special, consequential or incidental damages. **onsemi** does not convey any license under its patent rights nor the rights of others.

onsemi, **Onsemi**, and other names, marks, and brands are registered and/or common law trademarks of Semiconductor Components Industries, LLC dba "**onsemi**" or its affiliates and/or subsidiaries in the United States and/or other countries. **onsemi** owns the rights to a number of patents, trademarks, copyrights, trade secrets, and other intellectual property. A listing of **onsemi**'s product/patent coverage may be accessed at www.onsemi.com/site/pdf/Patent-Marking.pdf. **onsemi** reserves the right to make changes at any time to any products or information herein, without notice. The information herein is provided "as-is" and **onsemi** makes no warranty, representation or guarantee regarding the accuracy of the information, product features, availability, functionality, or suitability of its products for any particular purpose, nor does **onsemi** assume any liability arising out of the application or use of any product or circuit, and specifically disclaims any and all liability, including without limitation special, consequential or incidental damages. Buyer is responsible for its products and applications using **onsemi** products, including compliance with all laws, regulations and safety requirements or standards, regardless of any support or applications information provided by **onsemi**. "Typical" parameters which may be provided in **onsemi** data sheets and/or specifications can and do vary in different applications and actual performance may vary over time. All operating parameters, including "Typicals" must be validated for each customer application by customer's technical experts. **onsemi** does not convey any license under any of its intellectual property rights nor the rights of others. **onsemi** products are not designed, intended, or authorized for use as a critical component in life support systems or any FDA Class 3 medical devices or medical devices with a same or similar classification in a foreign jurisdiction or any devices intended for implantation in the human body. Should Buyer purchase or use **onsemi** products for any such unintended or unauthorized application, Buyer shall indemnify and hold **onsemi** and its officers, employees, subsidiaries, affiliates, and distributors harmless against all claims, costs, damages, and expenses, and reasonable attorney fees arising out of, directly or indirectly, any claim of personal injury or death associated with such unintended or unauthorized use, even if such claim alleges that **onsemi** was negligent regarding the design or manufacture of the part. **onsemi** is an Equal Opportunity/Affirmative Action Employer. This literature is subject to all applicable copyright laws and is not for resale in any manner.

ADDITIONAL INFORMATION

TECHNICAL PUBLICATIONS:

Technical Library: www.onsemi.com/design/resources/technical-documentation
onsemi Website: www.onsemi.com

ONLINE SUPPORT: www.onsemi.com/support

For additional information, please contact your local Sales Representative at www.onsemi.com/support/sales

OUR CERTIFICATE

DiGi provide top-quality products and perfect service for customer worldwide through standardization, technological innovation and continuous improvement. DiGi through third-party certification, we stricly control the quality of products and services. Welcome your RFQ to

Email: Info@DiGi-Electronics.com



Tel: +00 852-30501935

RFQ Email: Info@DiGi-Electronics.com

DiGi is a global authorized distributor of electronic components.