

ECH8660-TL-H Datasheet

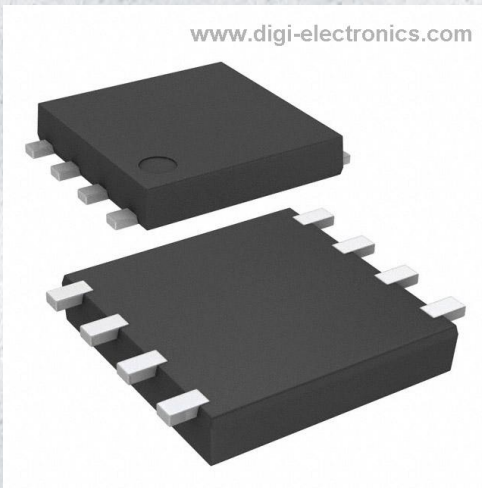

<https://www.DiGi-Electronics.com>

DiGi Electronics Part Number	ECH8660-TL-H-DG
Manufacturer	onsemi
Manufacturer Product Number	ECH8660-TL-H
Description	MOSFET N/P-CH 30V 4.5A 8ECH
Detailed Description	Mosfet Array 30V 4.5A 1.5W Surface Mount 8-ECH



Tel: +00 852-30501935

RFQ Email: Info@DiGi-Electronics.com

DiGi is a global authorized distributor of electronic components.

Purchase and inquiry

Manufacturer Product Number:

ECH8660-TL-H

Series:

-

Technology:

MOSFET (Metal Oxide)

FET Feature:

Logic Level Gate

Current - Continuous Drain (Id) @ 25°C:

4.5A

Vgs(th) (Max) @ Id:

-

Input Capacitance (Ciss) (Max) @ Vds:

240pF @ 10V

Operating Temperature:

150°C (TJ)

Package / Case:

8-SMD, Flat Lead

Base Product Number:

ECH8660

Manufacturer:

onsemi

Product Status:

Active

Configuration:

N and P-Channel

Drain to Source Voltage (Vdss):

30V

Rds On (Max) @ Id, Vgs:

59mOhm @ 2A, 10V

Gate Charge (Qg) (Max) @ Vgs:

4.4nC @ 10V

Power - Max:

1.5W

Mounting Type:

Surface Mount

Supplier Device Package:

8-ECH

Environmental & Export classification

RoHS Status:

ROHS3 Compliant

REACH Status:

REACH Unaffected

HTSUS:

8541.29.0095

Moisture Sensitivity Level (MSL):

1 (Unlimited)

ECCN:

EAR99

Ordering number : ENA1358B



ECH8660

Power MOSFET

30V, 4.5A, 59mΩ, -30V, -4.5A, 59mΩ, Complementary Dual ECH8

ON Semiconductor®

http://onsemi.com

Features

- The ECH8660 incorporates an N-channel MOSFET and a P-channel MOSFET that feature low ON-resistance and high-speed switching , thereby enabling high-density mounting
- 4V drive
- Halogen free compliance

Specifications

Absolute Maximum Ratings at Ta=25°C

Parameter	Symbol	Conditions	N-channel	P-channel	Unit
Drain-to-Source Voltage	V _{DSS}		30	-30	V
Gate-to-Source Voltage	V _{GSS}		±20	±20	V
Drain Current (DC)	I _D		4.5	-4.5	A
Drain Current (Pulse)	I _{DP}	PW≤10μs, duty cycle≤1%	30	-30	A
Allowable Power Dissipation	P _D	When mounted on ceramic substrate (1200mm ² ×0.8mm) 1unit	1.3		W
Total Dissipation	P _T	When mounted on ceramic substrate (1200mm ² ×0.8mm)	1.5		W
Channel Temperature	T _{ch}		150		°C
Storage Temperature	T _{stg}		-55 to +150		°C

Stresses exceeding Maximum Ratings may damage the device. Maximum Ratings are stress ratings only. Functional operation above the Recommended Operating Conditions is not implied. Extended exposure to stresses above the Recommended Operating Conditions may affect device reliability.

Package Dimensions

unit : mm (typ)

7011A-001

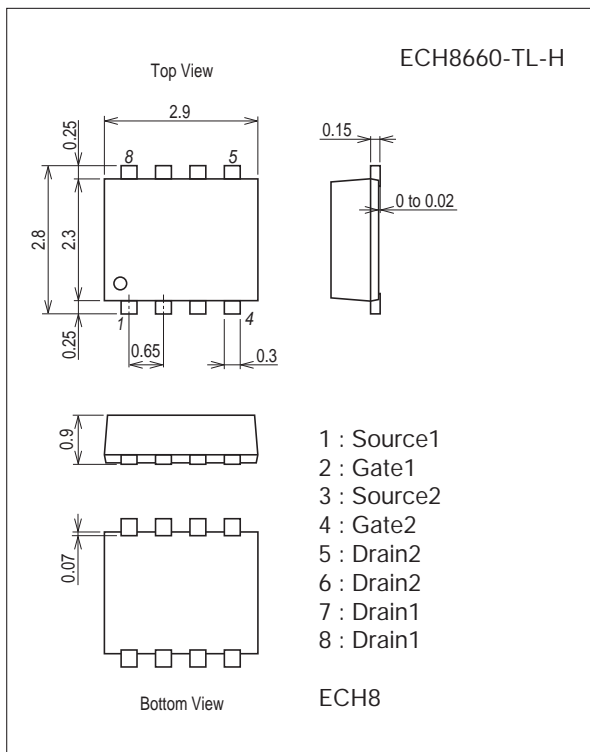

Product & Package Information

- Package : ECH8
- JEITA, JEDEC : -
- Minimum Packing Quantity : 3,000 pcs./reel

Packing Type : TL

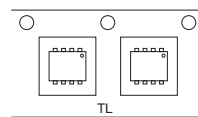

Marking

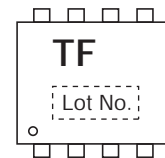

Electrical Connection

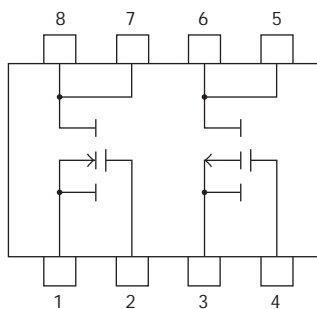

ECH8660

Electrical Characteristics at Ta=25°C

Parameter	Symbol	Conditions	Ratings			Unit
			min	typ	max	
[N-channel]						
Drain-to-Source Breakdown Voltage	$V_{(BR)DSS}$	$I_D=1mA, V_{GS}=0V$	30			V
Zero-Gate Voltage Drain Current	I_{DSS}	$V_{DS}=30V, V_{GS}=0V$			1	μA
Gate-to-Source Leakage Current	I_{GSS}	$V_{GS}=\pm 16V, V_{DS}=0V$			± 10	μA
Cutoff Voltage	$V_{GS(off)}$	$V_{DS}=10V, I_D=1mA$	1.2		2.6	V
Forward Transfer Admittance	$ y_{fs} $	$V_{DS}=10V, I_D=2A$	1	1.66		S
Static Drain-to-Source On-State Resistance	$R_{DS(on)1}$	$I_D=2A, V_{GS}=10V$		45	59	$m\Omega$
	$R_{DS(on)2}$	$I_D=1A, V_{GS}=4.5V$		85	119	$m\Omega$
	$R_{DS(on)3}$	$I_D=1A, V_{GS}=4V$		110	155	$m\Omega$
Input Capacitance	C_{iss}	$V_{DS}=10V, f=1MHz$		240		pF
Output Capacitance	C_{oss}	$V_{DS}=10V, f=1MHz$		45		pF
Reverse Transfer Capacitance	C_{rss}	$V_{DS}=10V, f=1MHz$		30		pF
Turn-ON Delay Time	$t_{d(on)}$	See specified Test Circuit.		6.2		ns
Rise Time	t_r	See specified Test Circuit.		11		ns
Turn-OFF Delay Time	$t_{d(off)}$	See specified Test Circuit.		17		ns
Fall Time	t_f	See specified Test Circuit.		7.5		ns
Total Gate Charge	Q_g	$V_{DS}=10V, V_{GS}=10V, I_D=4.5A$		4.4		nC
Gate-to-Source Charge	Q_{gs}	$V_{DS}=10V, V_{GS}=10V, I_D=4.5A$		1.1		nC
Gate-to-Drain "Miller" Charge	Q_{gd}	$V_{DS}=10V, V_{GS}=10V, I_D=4.5A$		0.64		nC
Diode Forward Voltage	V_{SD}	$I_S=4.5A, V_{GS}=0V$		0.84	1.2	V
[P-channel]						
Drain-to-Source Breakdown Voltage	$V_{(BR)DSS}$	$I_D=-1mA, V_{GS}=0V$	-30			V
Zero-Gate Voltage Drain Current	I_{DSS}	$V_{DS}=-30V, V_{GS}=0V$			-1	μA
Gate-to-Source Leakage Current	I_{GSS}	$V_{GS}=\pm 16V, V_{DS}=0V$			± 10	μA
Cutoff Voltage	$V_{GS(off)}$	$V_{DS}=-10V, I_D=-1mA$	-1.2		-2.3	V
Forward Transfer Admittance	$ y_{fs} $	$V_{DS}=-10V, I_D=-2A$	2.5	4.2		S
Static Drain-to-Source On-State Resistance	$R_{DS(on)1}$	$I_D=-2A, V_{GS}=-10V$		45	59	$m\Omega$
	$R_{DS(on)2}$	$I_D=-1A, V_{GS}=-4.5V$		71	100	$m\Omega$
	$R_{DS(on)3}$	$I_D=-1A, V_{GS}=-4V$		82	115	$m\Omega$
Input Capacitance	C_{iss}	$V_{DS}=-10V, f=1MHz$		430		pF
Output Capacitance	C_{oss}	$V_{DS}=-10V, f=1MHz$		105		pF
Reverse Transfer Capacitance	C_{rss}	$V_{DS}=-10V, f=1MHz$		75		pF
Turn-ON Delay Time	$t_{d(on)}$	See specified Test Circuit.		7.5		ns
Rise Time	t_r	See specified Test Circuit.		26		ns
Turn-OFF Delay Time	$t_{d(off)}$	See specified Test Circuit.		45		ns
Fall Time	t_f	See specified Test Circuit.		35		ns
Total Gate Charge	Q_g	$V_{DS}=-10V, V_{GS}=-10V, I_D=-4.5A$		10		nC
Gate-to-Source Charge	Q_{gs}	$V_{DS}=-10V, V_{GS}=-10V, I_D=-4.5A$		2.0		nC
Gate-to-Drain "Miller" Charge	Q_{gd}	$V_{DS}=-10V, V_{GS}=-10V, I_D=-4.5A$		2.5		nC
Diode Forward Voltage	V_{SD}	$I_S=-4.5A, V_{GS}=0V$		-0.85	-1.2	V

Switching Time Test Circuit

[N-channel]

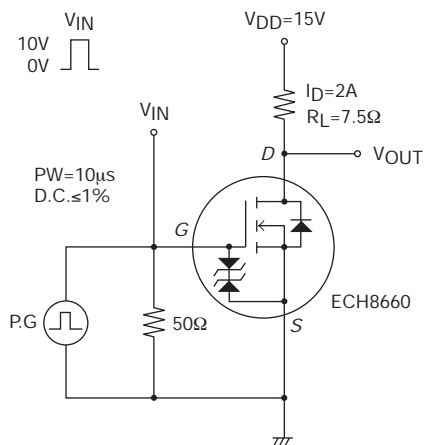

[P-channel]

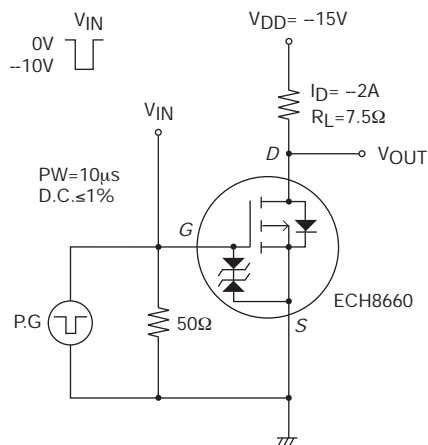

ECH8660

Ordering Information

Device	Package	Shipping	memo
ECH8660-TL-H	ECH8	3,000pcs./reel	Pb-Free and Halogen Free

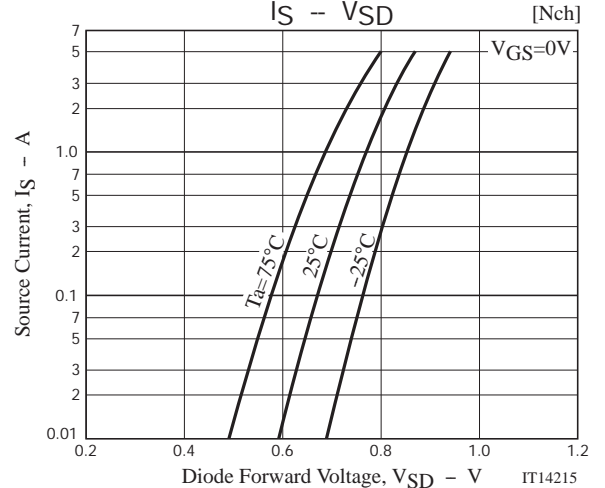
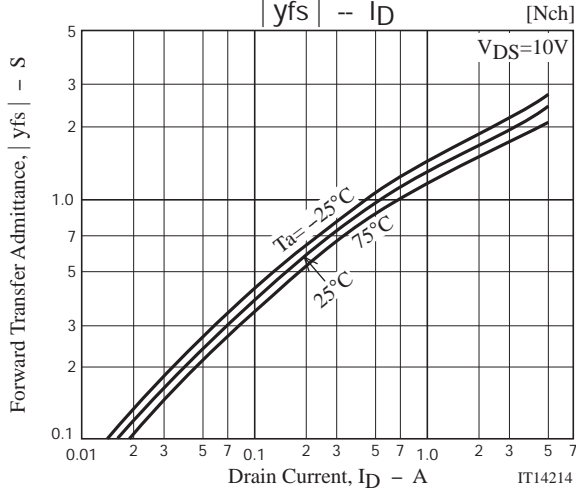
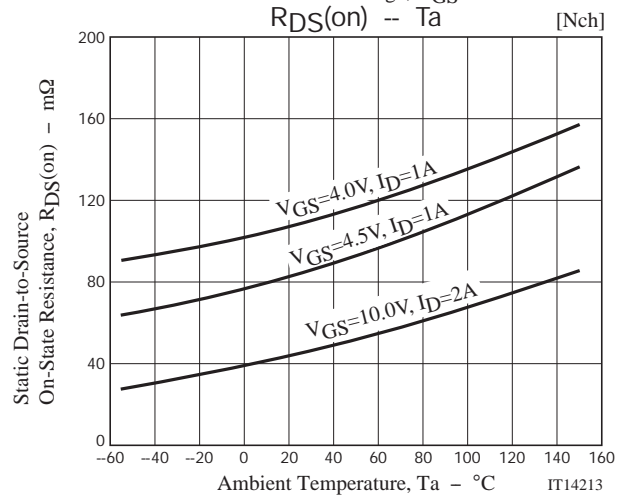
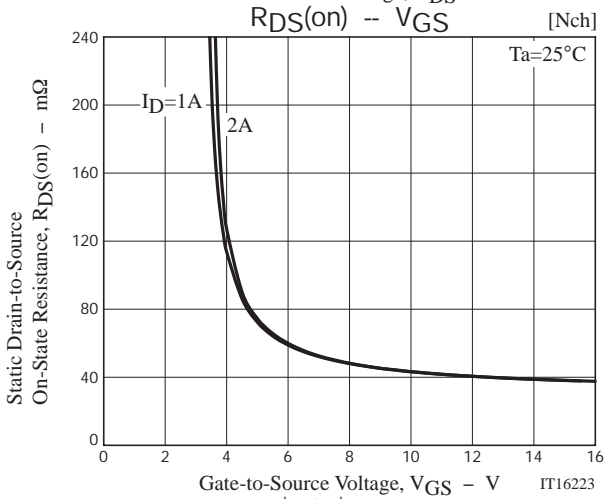
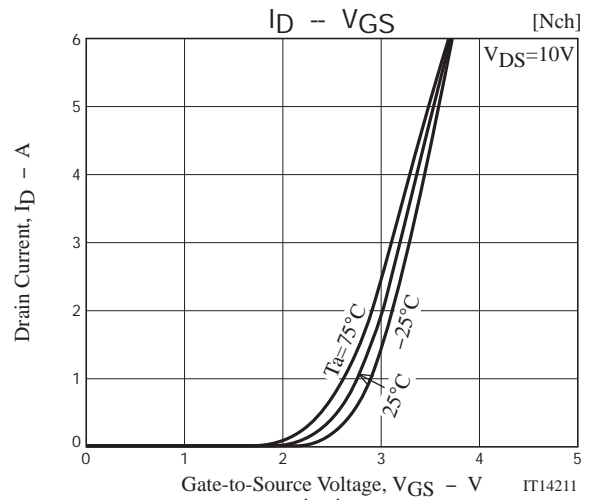
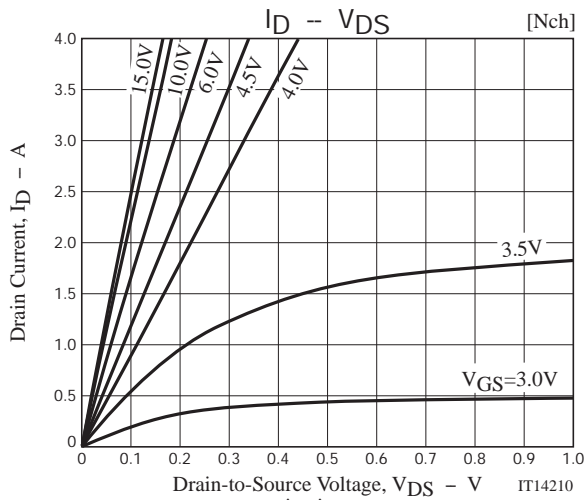

ECH8660

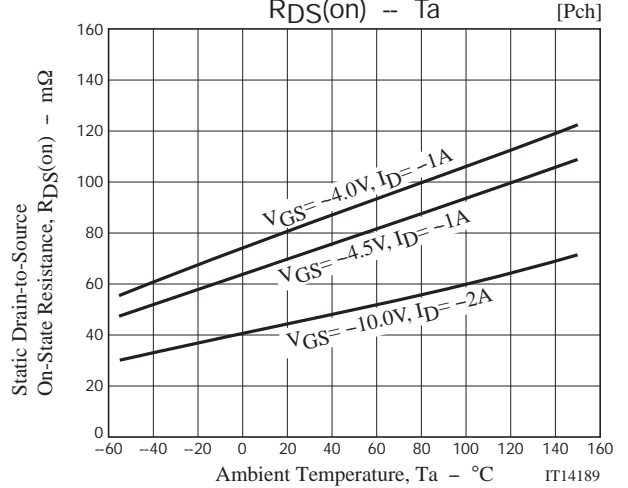
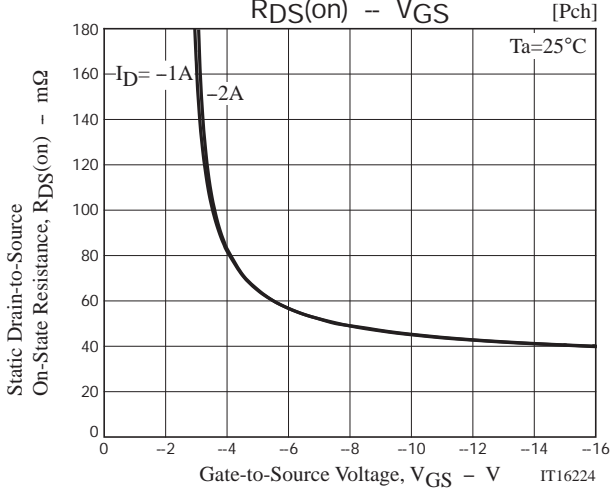
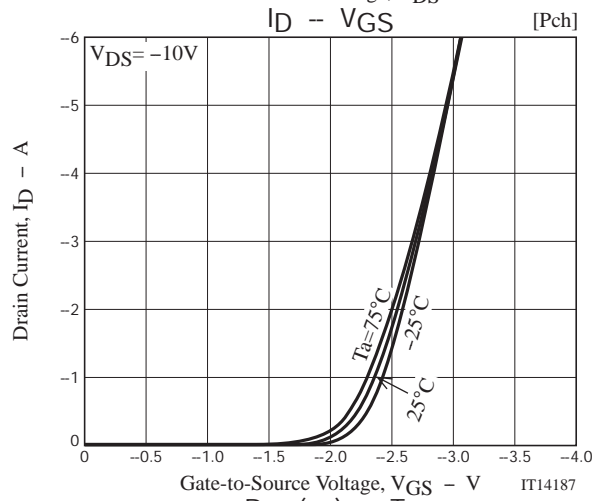
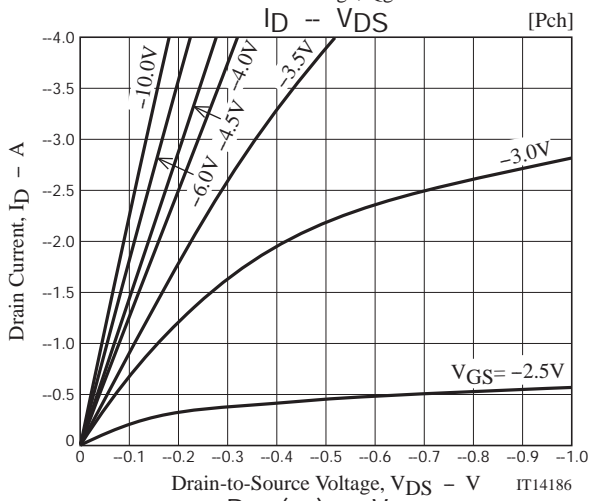
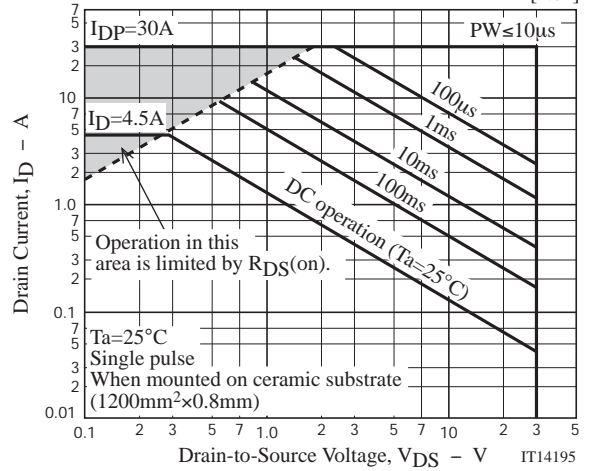
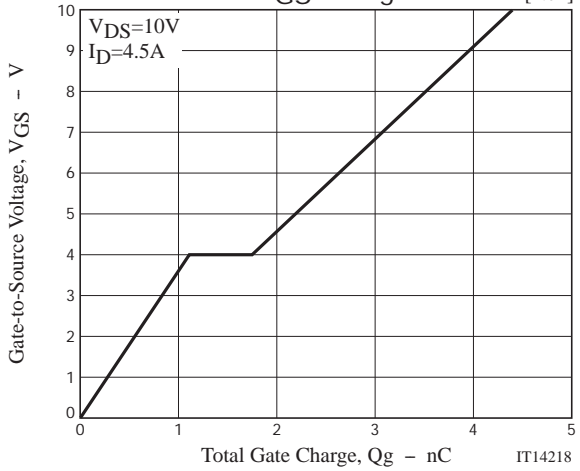
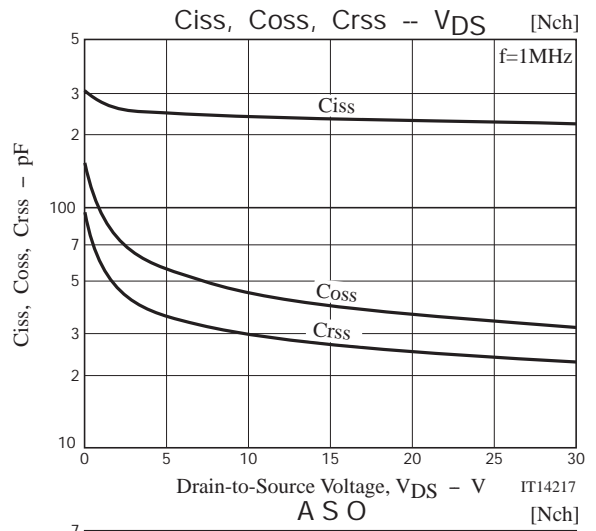
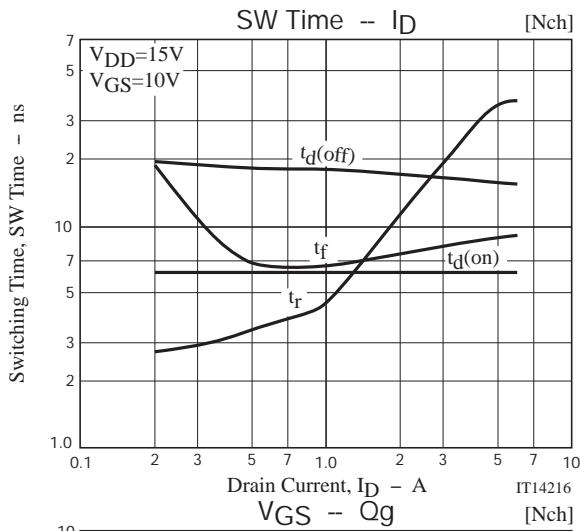

ECH8660

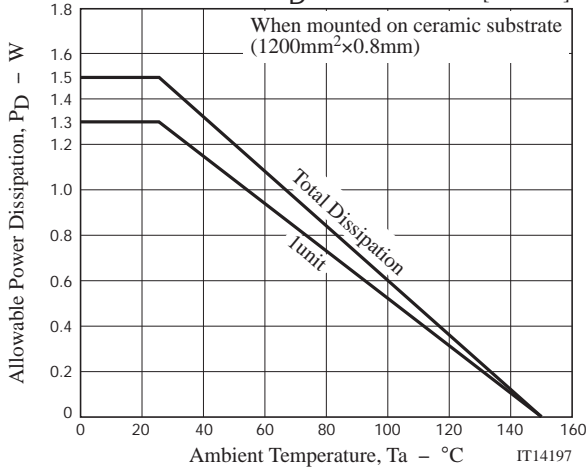
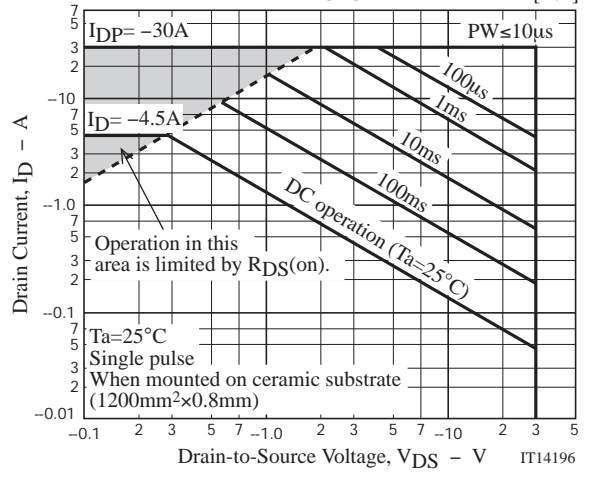
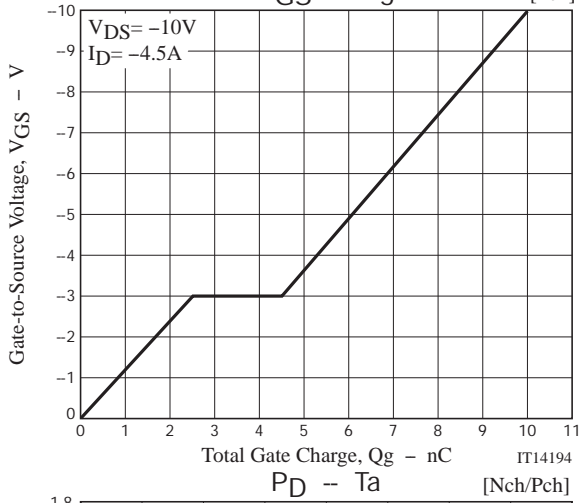
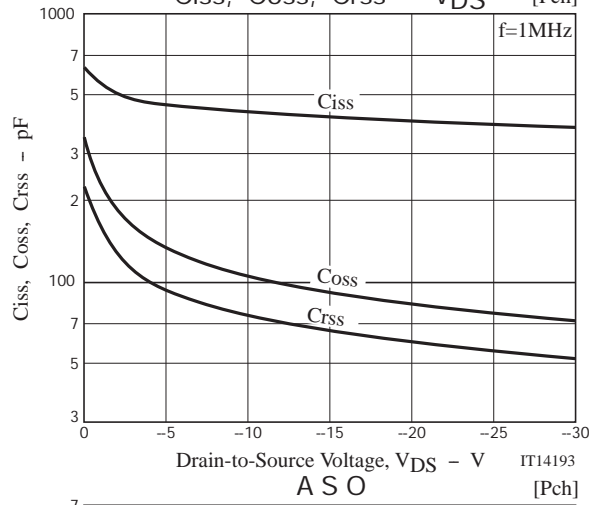
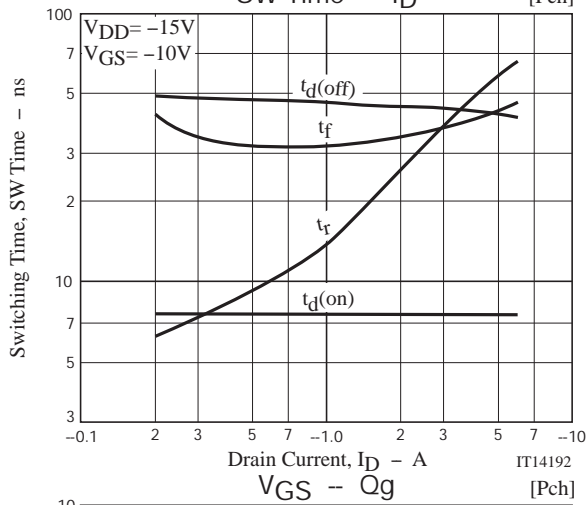
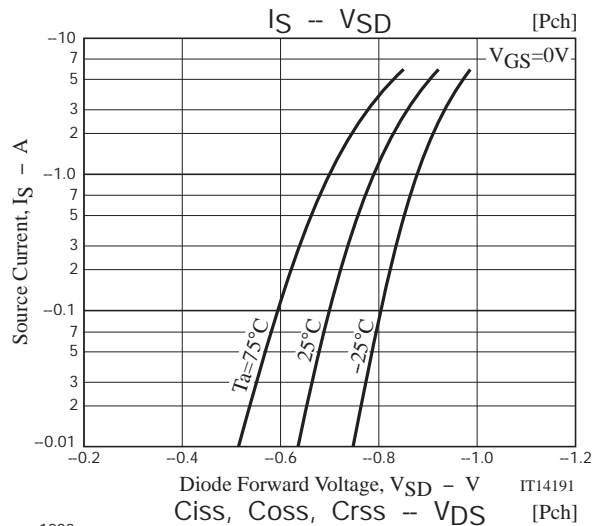
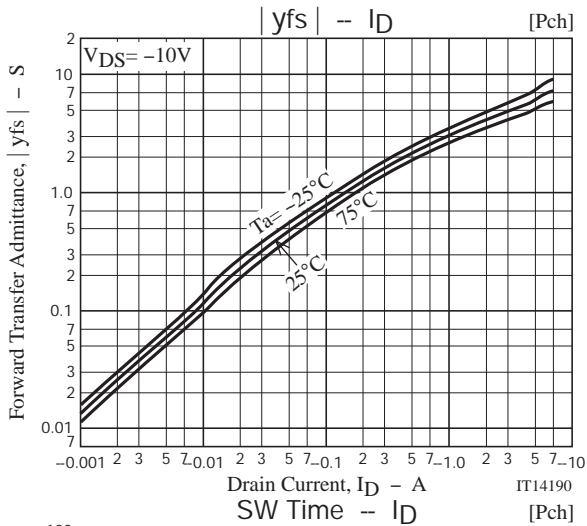

ECH8660

Embossed Taping Specification

ECH8660-TL-H

1. Packing Format

Package Name	Carrier Tape Type	Maximum Number of devices contained (pcs)			Packing format	
		Reel	Inner box	Outer box	Inner BOX (C-1)	Outer BOX (A-7)
ECH8	CPH6	3,000	15,000	90,000	5 reels contained Dimensions:mm (external) 183×72×185	6 inner boxes contained Dimensions:mm (external) 440×195×210

Reel label, Inner box label
(unit :mm)

Outer box label

It is a label at the time of factory shipments.
The form of a label may change in physical distribution process.

Packing method

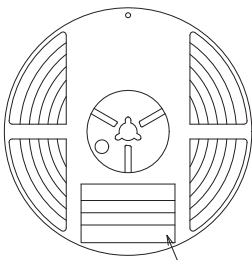

Reel label

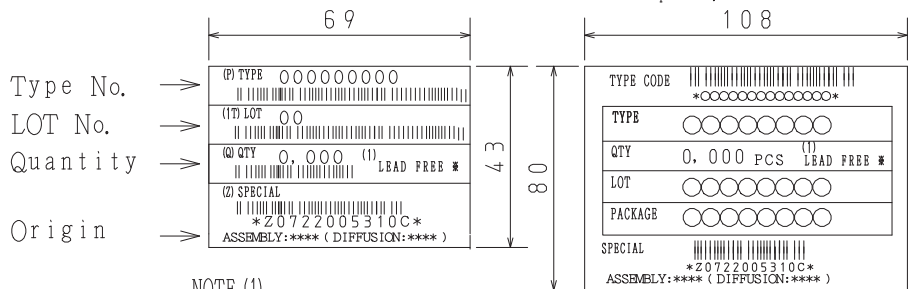

NOTE (1)

The LEAD FREE * description shows that the surface treatment of the terminal is lead free.

Label	JEITA Phase
LEAD FREE 3	JEITA Phase 3A
LEAD FREE 4	JEITA Phase 3

2. Taping configuration

2-1. Carrier tape size (unit:mm)

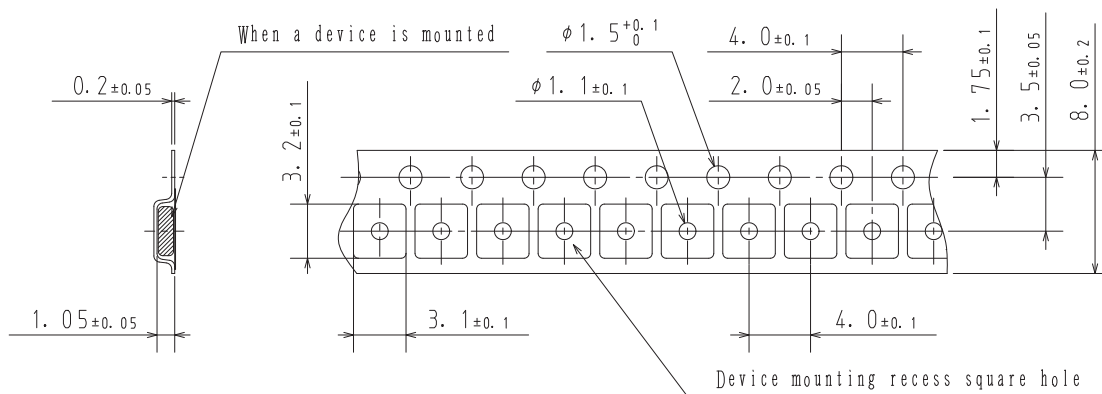

2-2. Device placement direction

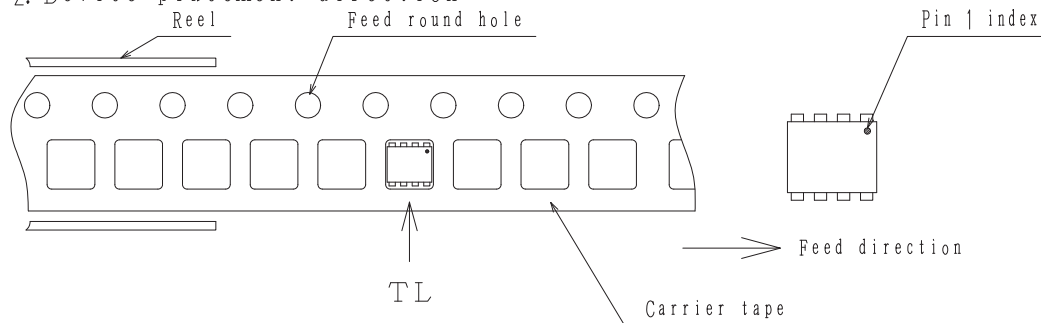

Those with pin 1 index on the feed hole side.....TL

ECH8660

Outline Drawing ECH8660-TL-H

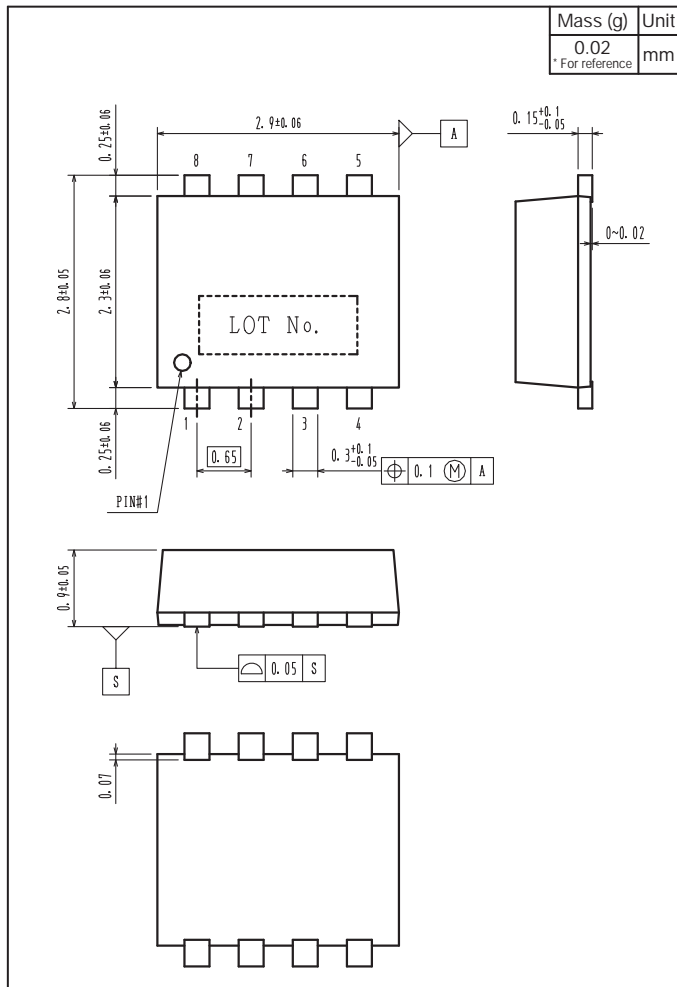

Land Pattern Example

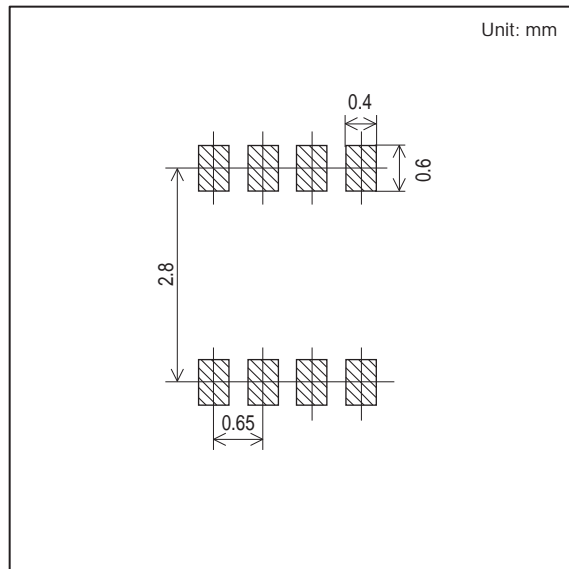

ECH8660

Note on usage : Since the ECH8660 is a MOSFET product, please avoid using this device in the vicinity of highly charged objects.

ON Semiconductor and the ON logo are registered trademarks of Semiconductor Components Industries, LLC (SCILLC). SCILLC owns the rights to a number of patents, trademarks, copyrights, trade secrets, and other intellectual property. A listing of SCILLC's product/patent coverage may be accessed at www.onsemi.com/site/pdf/Patent-Marking.pdf. SCILLC reserves the right to make changes without further notice to any products herein. SCILLC makes no warranty, representation or guarantee regarding the suitability of its products for any particular purpose, nor does SCILLC assume any liability arising out of the application or use of any product or circuit, and specifically disclaims any and all liability, including without limitation special, consequential or incidental damages. "Typical" parameters which may be provided in SCILLC data sheets and/or specifications can and do vary in different applications and actual performance may vary over time. All operating parameters, including "Typicals" must be validated for each customer application by customer's technical experts. SCILLC does not convey any license under its patent rights nor the rights of others. SCILLC products are not designed, intended, or authorized for use as components in systems intended for surgical implant into the body, or other applications intended to support or sustain life, or for any other application in which the failure of the SCILLC product could create a situation where personal injury or death may occur. Should Buyer purchase or use SCILLC products for any such unintended or unauthorized application, Buyer shall indemnify and hold SCILLC and its officers, employees, subsidiaries, affiliates, and distributors harmless against all claims, costs, damages, and expenses, and reasonable attorney fees arising out of, directly or indirectly, any claim of personal injury or death associated with such unintended or unauthorized use, even if such claim alleges that SCILLC was negligent regarding the design or manufacture of the part. SCILLC is an Equal Opportunity/Affirmative Action Employer. This literature is subject to all applicable copyright laws and is not for resale in any manner.

OUR CERTIFICATE

DiGi provide top-quality products and perfect service for customer worldwide through standardization, technological innovation and continuous improvement. DiGi through third-party certification, we stricly control the quality of products and services. Welcome your RFQ to

Email: Info@DiGi-Electronics.com



Tel: +00 852-30501935

RFQ Email: Info@DiGi-Electronics.com

DiGi is a global authorized distributor of electronic components.