

EMH2604-TL-H Datasheet



<https://www.DiGi-Electronics.com>

DiGi Electronics Part Number	EMH2604-TL-H-DG
Manufacturer	onsemi
Manufacturer Product Number	EMH2604-TL-H
Description	MOSFET N/P-CH 20V 4A/3A 8EMH
Detailed Description	Mosfet Array 20V 4A, 3A 1.2W Surface Mount 8-EMH



Tel: +00 852-30501935

RFQ Email: Info@DiGi-Electronics.com

DiGi is a global authorized distributor of electronic components.

Purchase and inquiry

Manufacturer Product Number:

EMH2604-TL-H

Series:

-

Technology:

MOSFET (Metal Oxide)

FET Feature:

Logic Level Gate

Current - Continuous Drain (Id) @ 25°C:

4A, 3A

Vgs(th) (Max) @ Id:

-

Input Capacitance (Ciss) (Max) @ Vds:

345pF @ 10V

Operating Temperature:

150°C (TJ)

Package / Case:

8-SMD, Flat Lead

Base Product Number:

EMH2604

Manufacturer:

onsemi

Product Status:

Obsolete

Configuration:

N and P-Channel

Drain to Source Voltage (Vdss):

20V

Rds On (Max) @ Id, Vgs:

45mOhm @ 4A, 4.5V

Gate Charge (Qg) (Max) @ Vgs:

4.7nC @ 4.5V

Power - Max:

1.2W

Mounting Type:

Surface Mount

Supplier Device Package:

8-EMH

Environmental & Export classification

Moisture Sensitivity Level (MSL):

1 (Unlimited)

ECCN:

EAR99

REACH Status:

REACH Unaffected

HTSUS:

8541.29.0095

Ordering number : EN9006A



EMH2604

Power MOSFET

20V, 4A, 45mΩ, -20V, -3A, 85mΩ, Complementary Dual EMH8

ON Semiconductor®

<http://onsemi.com>

Features

- Nch + Pch MOSFET
- ON-resistance Nch : $R_{DS(on)1}=34m\Omega$ (typ.)
Pch : $R_{DS(on)1}=65m\Omega$ (typ.)
- 1.8V drive
- Halogen free compliance

Specifications

Absolute Maximum Ratings at $T_a=25^\circ\text{C}$

Parameter	Symbol	Conditions	N-channel	P-channel	Unit
Drain-to-Source Voltage	V_{DSS}		20	-20	V
Gate-to-Source Voltage	V_{GSS}		± 10	± 10	V
Drain Current (DC)	I_D		4	-3	A
Drain Current (Pulse)	I_{DP}	$PW \leq 10\mu\text{s}$, duty cycle $\leq 1\%$	20	-20	A
Allowable Power Dissipation	P_D	When mounted on ceramic substrate (900mm ² ×0.8mm) 1unit	1.0		W
Total Dissipation	P_T	When mounted on ceramic substrate (900mm ² ×0.8mm)	1.2		W
Channel Temperature	T_{ch}		150		°C
Storage Temperature	T_{stg}		-55 to +150		°C

This product is designed to "ESD immunity < 200V**", so please take care when handling.

* Machine Model

Stresses exceeding Maximum Ratings may damage the device. Maximum Ratings are stress ratings only. Functional operation above the Recommended Operating Conditions is not implied. Extended exposure to stresses above the Recommended Operating Conditions may affect device reliability.

Package Dimensions

unit : mm (typ)

7045-002

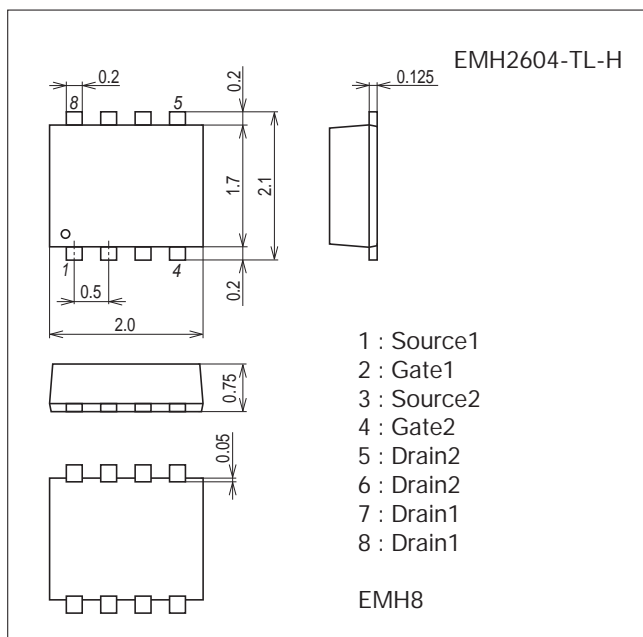

Product & Package Information

- Package : EMH8
- JEITA, JEDEC : -
- Minimum Packing Quantity : 3,000 pcs./reel

Packing Type : TL

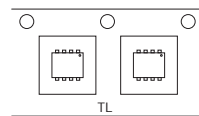

Marking

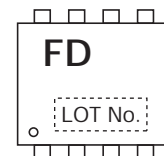

Electrical Connection

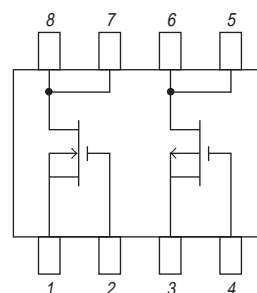

EMH2604

Electrical Characteristics at Ta=25°C

Parameter	Symbol	Conditions	Ratings			Unit
			min	typ	max	
[N-channel]						
Drain-to-Source Breakdown Voltage	V(BR)DSS	ID=1mA, VGS=0V	20			V
Zero-Gate Voltage Drain Current	IDSS	VDS=20V, VGS=0V			1	μA
Gate-to-Source Leakage Current	IGSS	VGS=±8V, VDS=0V			±10	μA
Cutoff Voltage	VGS(off)	VDS=10V, ID=1mA	0.4		1.3	V
Forward Transfer Admittance	yfs	VDS=10V, ID=2A		3.4		S
Static Drain-to-Source On-State Resistance	RDS(on)1	ID=4A, VGS=4.5V		34	45	mΩ
	RDS(on)2	ID=1A, VGS=2.5V		49	67	mΩ
	RDS(on)3	ID=0.5A, VGS=1.8V		74	115	mΩ
Input Capacitance	Ciss	VDS=10V, f=1MHz		345		pF
Output Capacitance	Coss			67		pF
Reverse Transfer Capacitance	Crss			52		pF
Turn-ON Delay Time	t _{d(on)}		See specified Test Circuit.		9.2	
Rise Time	t _r			60		ns
Turn-OFF Delay Time	t _{d(off)}			30		ns
Fall Time	t _f			38		ns
Total Gate Charge	Qg	VDS=10V, VGS=4.5V, ID=4A			4.7	
Gate-to-Source Charge	Qgs			0.65		nC
Gate-to-Drain "Miller" Charge	Qgd			1.6		nC
Diode Forward Voltage	VSD		IS=4A, VGS=0V		0.8	1.2
[P-channel]						
Drain-to-Source Breakdown Voltage	V(BR)DSS	ID=-1mA, VGS=0V	-20			V
Zero-Gate Voltage Drain Current	IDSS	VDS=-20V, VGS=0V			-1	μA
Gate-to-Source Leakage Current	IGSS	VGS=±8V, VDS=0V			±10	μA
Cutoff Voltage	VGS(off)	VDS=-10V, ID=-1mA	-0.4		-1.3	V
Forward Transfer Admittance	yfs	VDS=-10V, ID=-1.5A		3.6		S
Static Drain-to-Source On-State Resistance	RDS(on)1	ID=-3A, VGS=-4.5V		65	85	mΩ
	RDS(on)2	ID=-1A, VGS=-2.5V		98	137	mΩ
	RDS(on)3	ID=-0.5A, VGS=-1.8V		155	235	mΩ
Input Capacitance	Ciss	VDS=-10V, f=1MHz		320		pF
Output Capacitance	Coss			66		pF
Reverse Transfer Capacitance	Crss			50		pF
Turn-ON Delay Time	t _{d(on)}		See specified Test Circuit.		7.1	
Rise Time	t _r			21		ns
Turn-OFF Delay Time	t _{d(off)}			37		ns
Fall Time	t _f			32		ns
Total Gate Charge	Qg	VDS=-10V, VGS=-4.5V, ID=-3A			4.0	
Gate-to-Source Charge	Qgs			0.6		nC
Gate-to-Drain "Miller" Charge	Qgd			1.1		nC
Diode Forward Voltage	VSD		IS=-3A, VGS=0V		-0.83	-1.2

EMH2604

Switching Time Test Circuit

[N-channel]

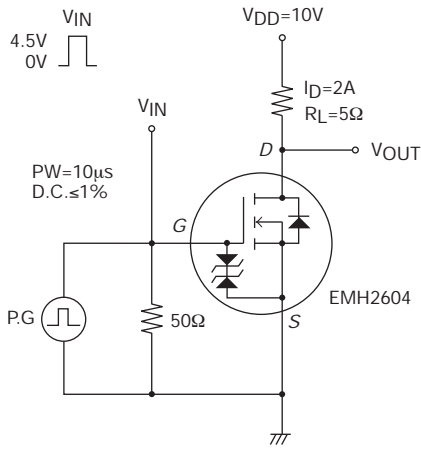

[P-channel]

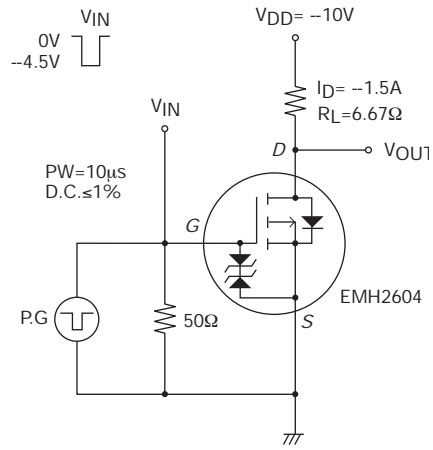

Ordering Information

Device	Package	Shipping	memo
EMH2604-TL-H	EMH8	3,000pcs./reel	Pb Free and Halogen Free

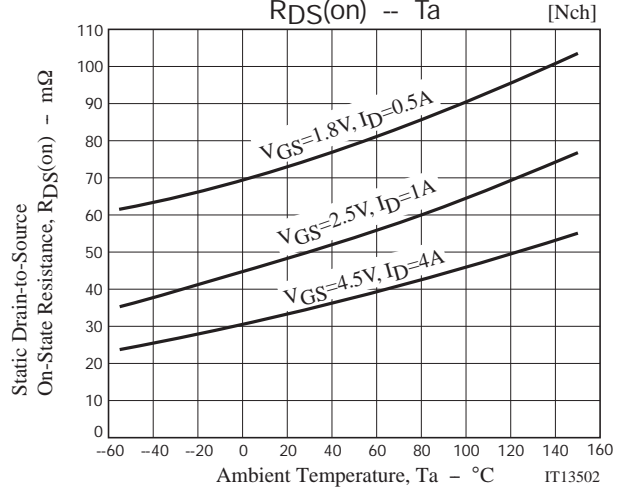
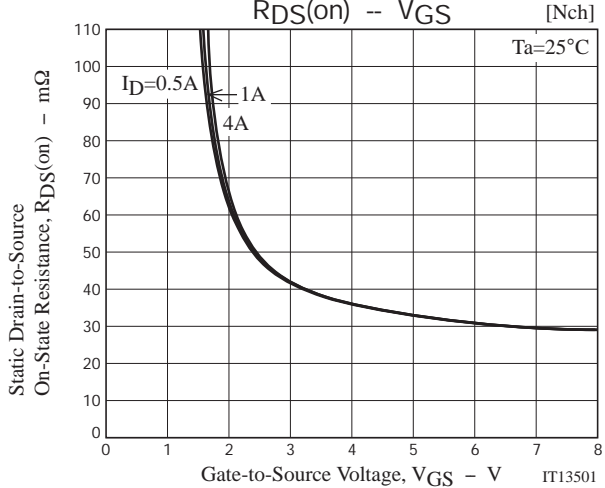
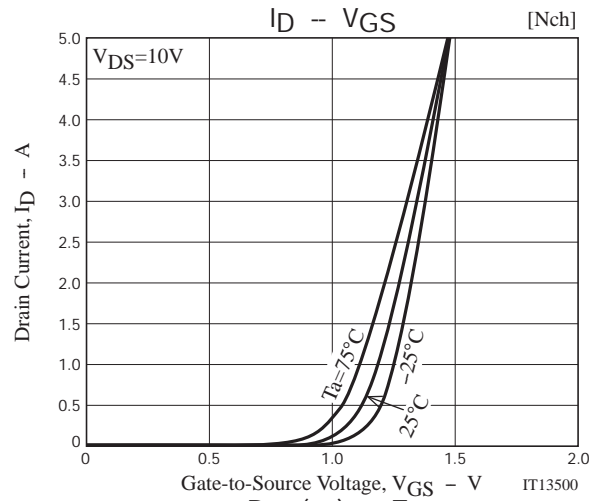
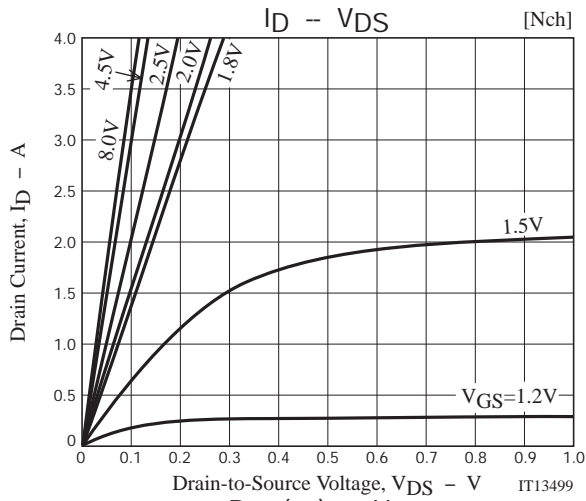

EMH2604

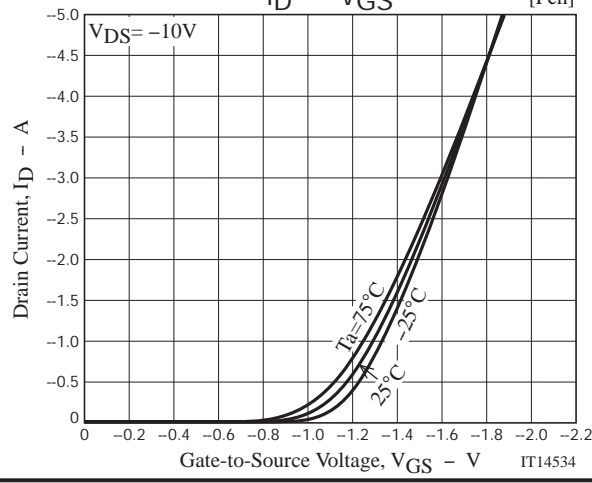
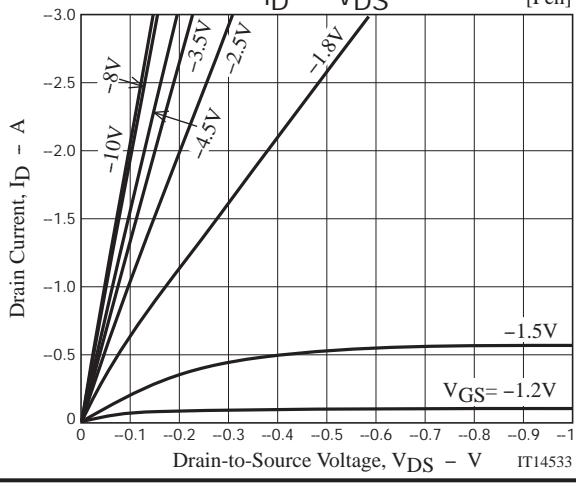
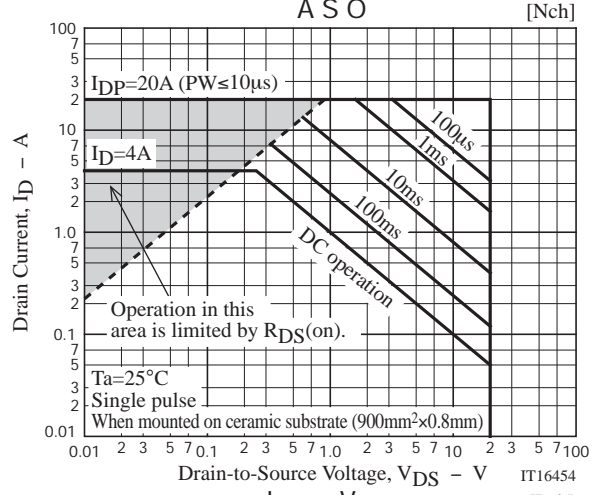
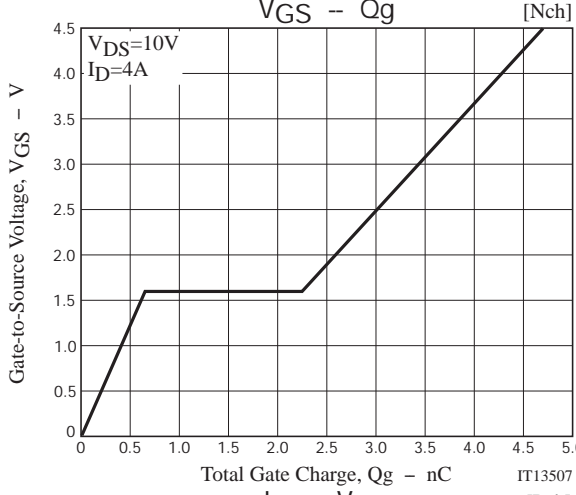
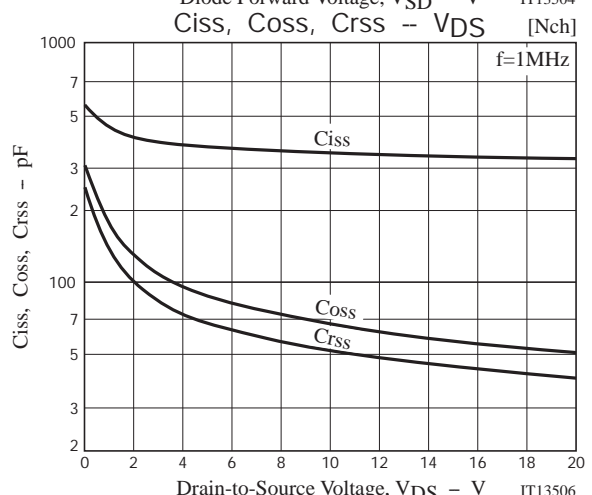
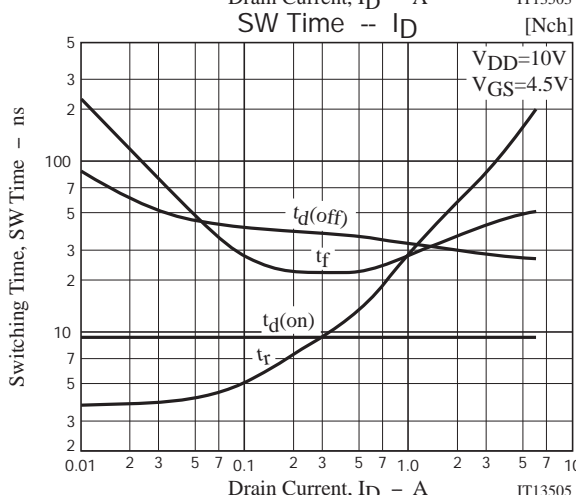
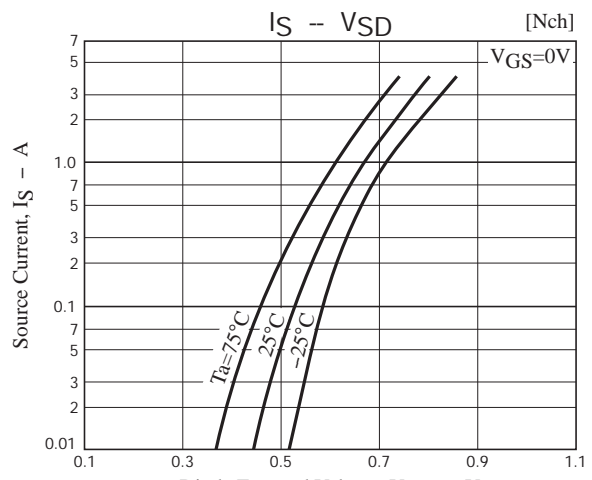
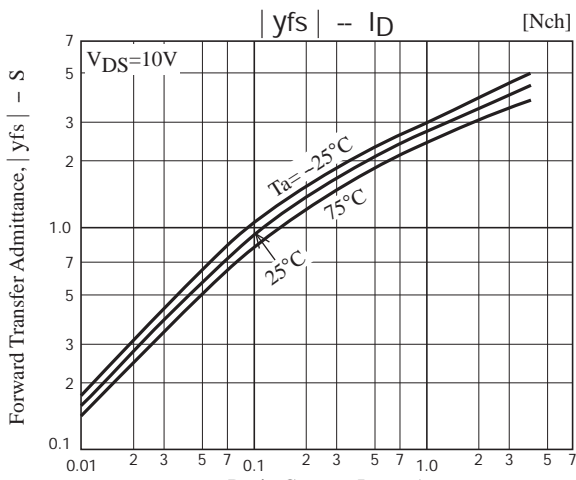

EMH2604

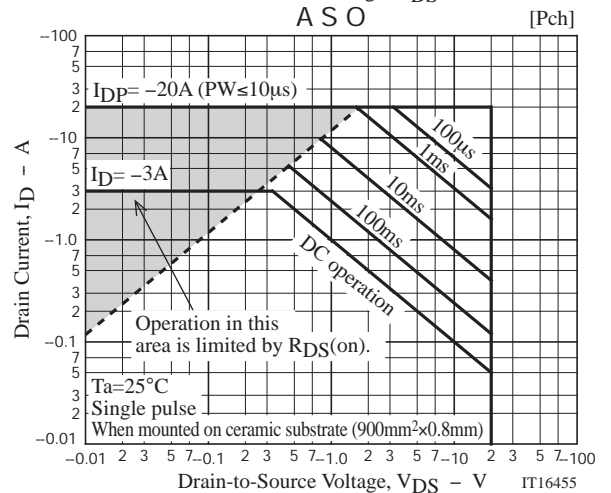
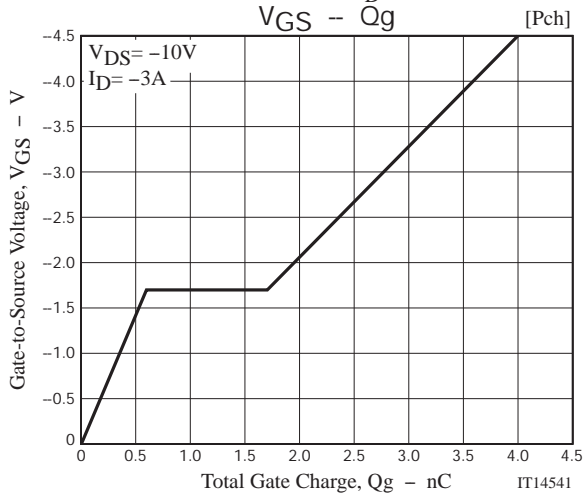
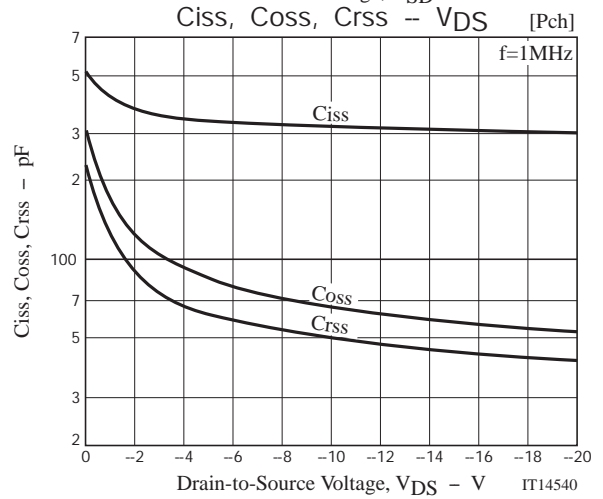
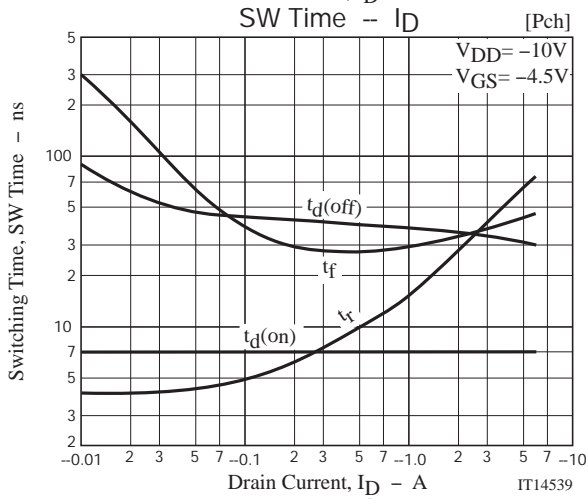
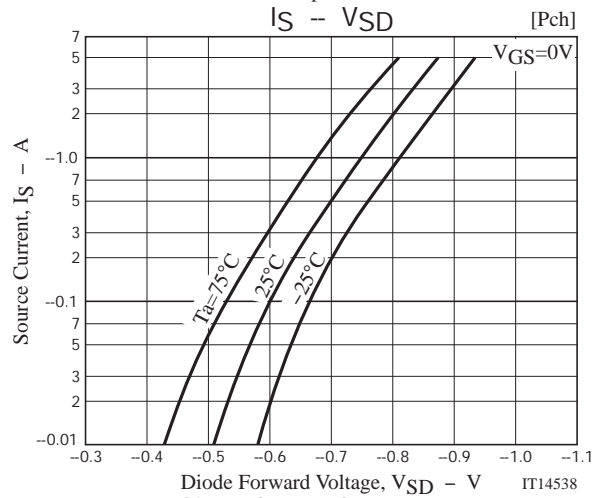
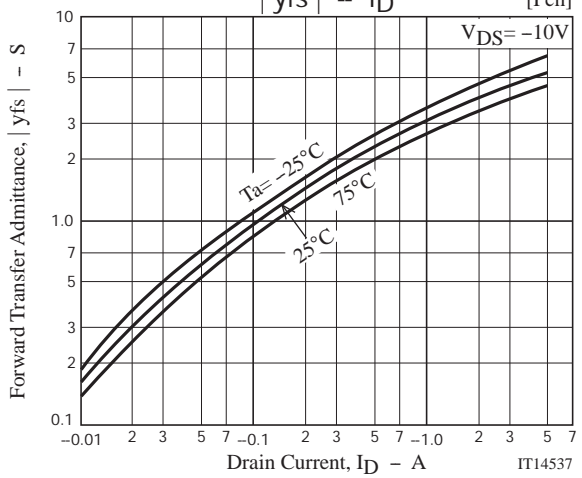
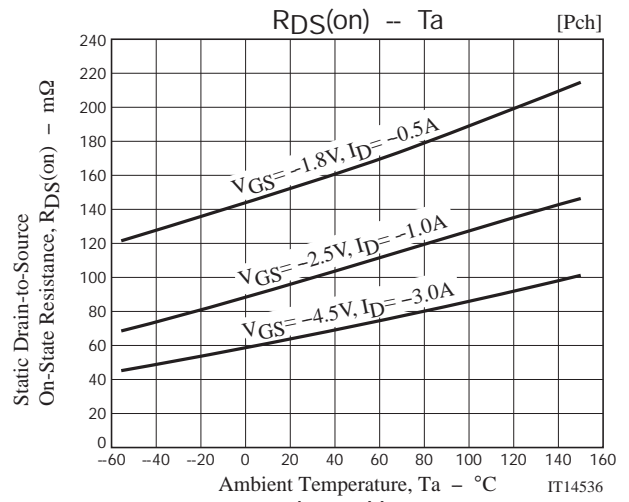
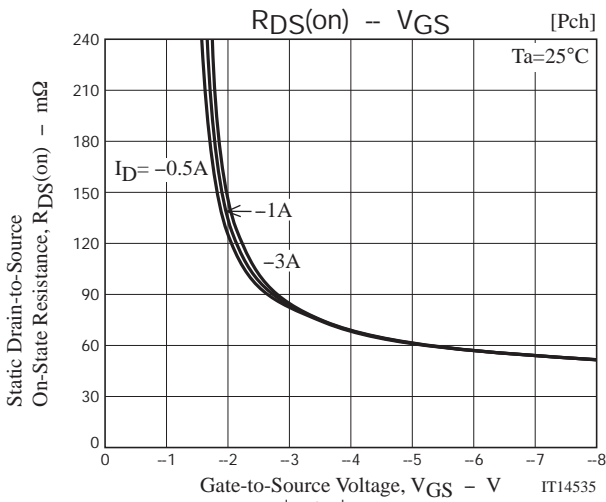

EMH2604

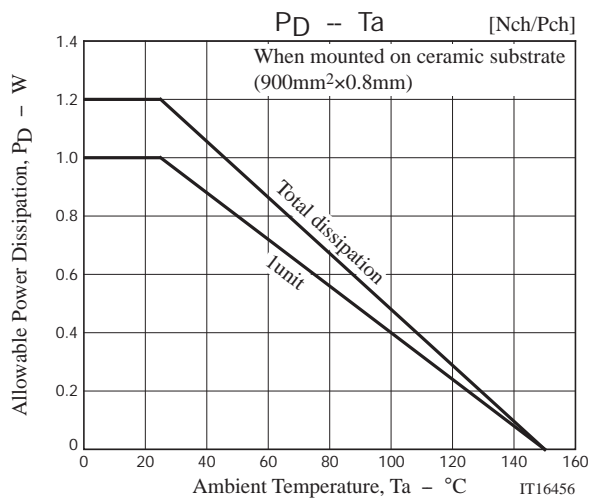

EMH2604

Embossed Taping Specification

EMH2604-TL-H

1. Packing Format

Package Name	Carrier Tape Type	Maximum Number of devices contained (pcs)			Packing format	
		Reel	Inner box	Outer box	Inner BOX (C-1)	Outer BOX (A-7)
EMH8	MCP4	3,000	15,000	90,000	5 reels contained Dimensions:mm (external) 183×72×185	6 inner boxes contained Dimensions:mm (external) 440×195×210

Packing method

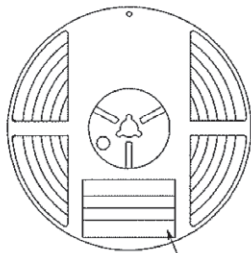

Reel label

Type No. →
 LOT No. →
 Quantity →
 Origin →

Reel label, Inner box label
(unit:mm)

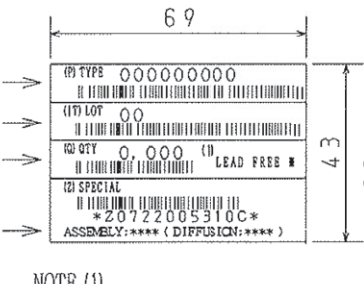

Outer box label

It is a label at the time of factory shipments. The form of a label may change in physical distribution process.

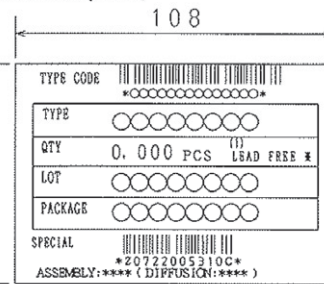

NOTE (1)

The LEAD FREE * description shows that the surface treatment of the terminal is lead free.

Label	JEITA Phase
LEAD FREE 3	JEITA Phase 3A
LEAD FREE 4	JEITA Phase 3

2. Taping configuration

2-1. Carrier tape size (unit:mm)

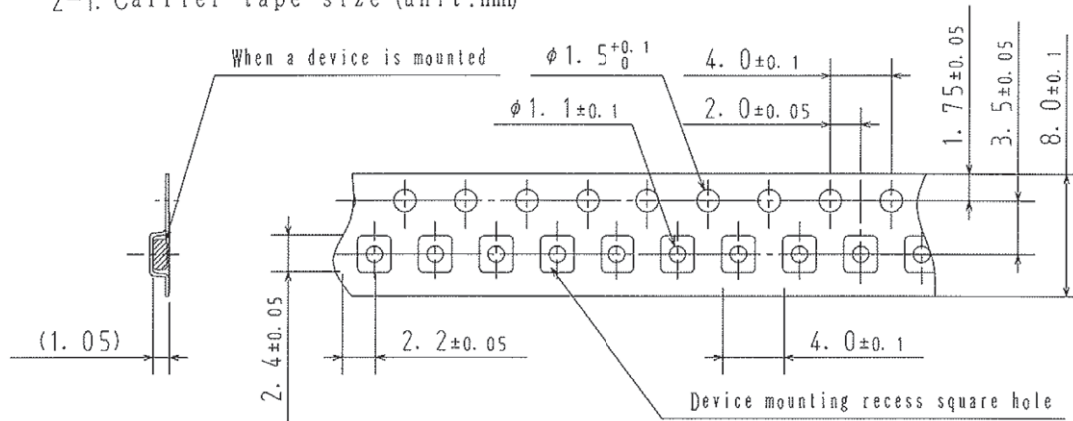

2-2. Device placement direction

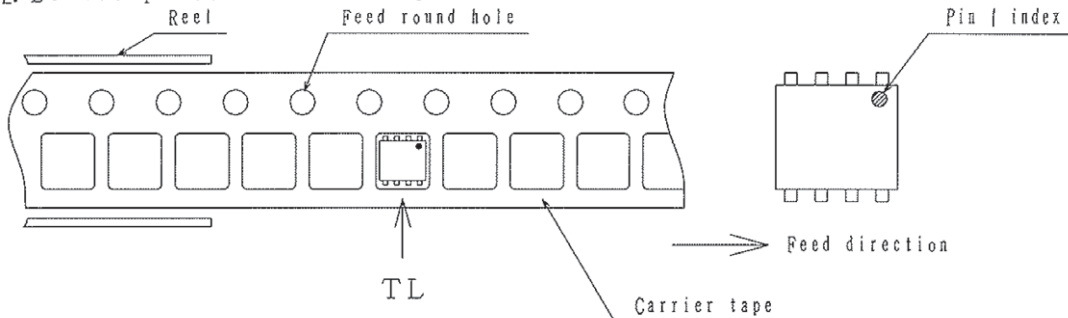

Those with pin 1 index on the feed hole side.....TL

EMH2604

Outline Drawing

EMH2604-TL-H

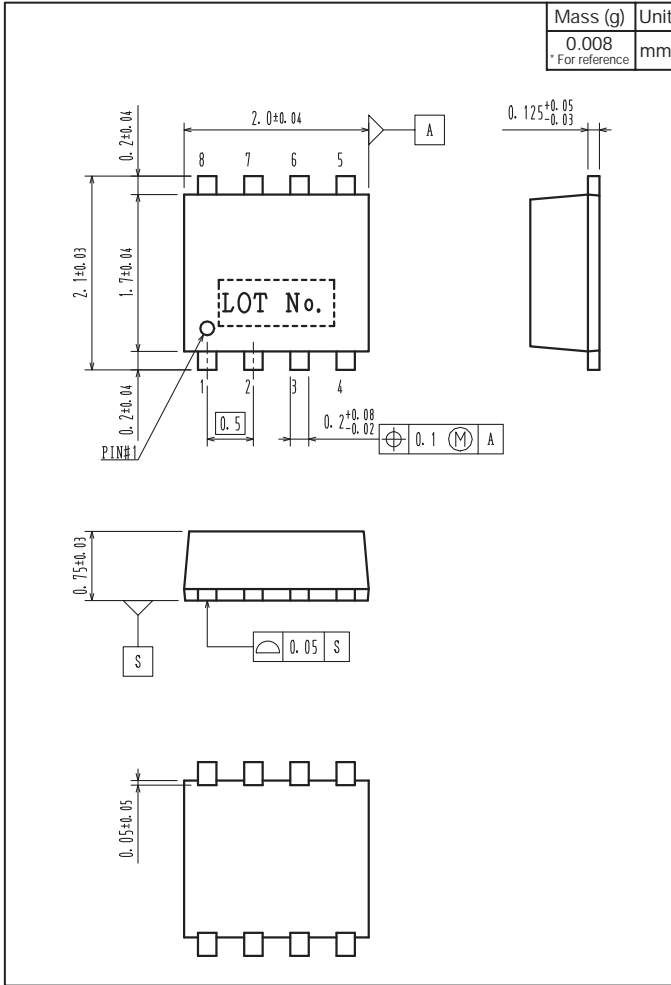

Land Pattern Example

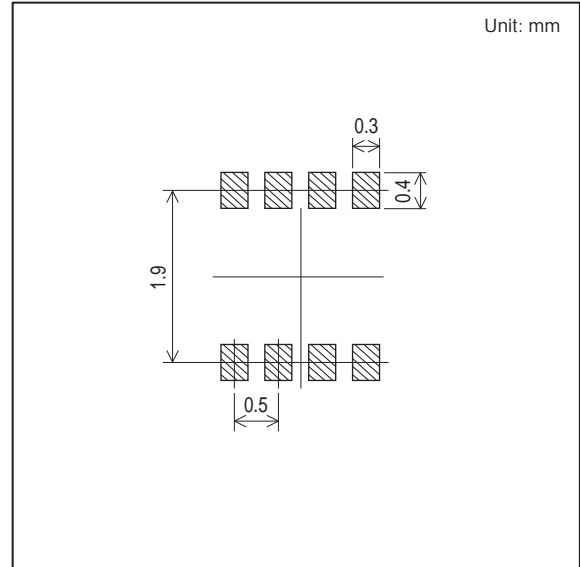

EMH2604

Note on usage : Since the EMH2604 is a MOSFET product, please avoid using this device in the vicinity of highly charged objects.

ON Semiconductor and the ON logo are registered trademarks of Semiconductor Components Industries, LLC (SCILLC). SCILLC owns the rights to a number of patents, trademarks, copyrights, trade secrets, and other intellectual property. A listing of SCILLC's product/patent coverage may be accessed at www.onsemi.com/site/pdf/Patent-Marking.pdf. SCILLC reserves the right to make changes without further notice to any products herein. SCILLC makes no warranty, representation or guarantee regarding the suitability of its products for any particular purpose, nor does SCILLC assume any liability arising out of the application or use of any product or circuit, and specifically disclaims any and all liability, including without limitation special, consequential or incidental damages. "Typical" parameters which may be provided in SCILLC data sheets and/or specifications can and do vary in different applications and actual performance may vary over time. All operating parameters, including "Typicals" must be validated for each customer application by customer's technical experts. SCILLC does not convey any license under its patent rights nor the rights of others. SCILLC products are not designed, intended, or authorized for use as components in systems intended for surgical implant into the body, or other applications intended to support or sustain life, or for any other application in which the failure of the SCILLC product could create a situation where personal injury or death may occur. Should Buyer purchase or use SCILLC products for any such unintended or unauthorized application, Buyer shall indemnify and hold SCILLC and its officers, employees, subsidiaries, affiliates, and distributors harmless against all claims, costs, damages, and expenses, and reasonable attorney fees arising out of, directly or indirectly, any claim of personal injury or death associated with such unintended or unauthorized use, even if such claim alleges that SCILLC was negligent regarding the design or manufacture of the part. SCILLC is an Equal Opportunity/Affirmative Action Employer. This literature is subject to all applicable copyright laws and is not for resale in any manner.

OUR CERTIFICATE

DiGi provide top-quality products and perfect service for customer worldwide through standardization, technological innovation and continuous improvement. DiGi through third-party certification, we stricly control the quality of products and services. Welcome your RFQ to

Email: Info@DiGi-Electronics.com



Tel: +00 852-30501935

RFQ Email: Info@DiGi-Electronics.com

DiGi is a global authorized distributor of electronic components.