

# FAN156L6X-F106 Datasheet



<https://www.DiGi-Electronics.com>

DiGi Electronics Part Number	FAN156L6X-F106-DG
Manufacturer	<a href="#">onsemi</a>
Manufacturer Product Number	FAN156L6X-F106
Description	IC COMPARATOR 1 GEN PUR 6MICROPK
Detailed Description	Comparator General Purpose Push-Pull, Rail-to-Rail 6-MicroPak



Tel: +00 852-30501935

RFQ Email: [Info@DiGi-Electronics.com](mailto:Info@DiGi-Electronics.com)

DiGi is a global authorized distributor of electronic components.

## Purchase and inquiry

Manufacturer Product Number:

FAN156L6X-F106

Series:

-

Type:

General Purpose

Output Type:

Push-Pull, Rail-to-Rail

Voltage - Input Offset (Max):

15mV @ 5.5V

Current - Output (Typ):

-

CMRR, PSRR (Typ):

68db CMRR, 80db PSRR

Hysteresis:

4mV

Package / Case:

6-UFDN

Supplier Device Package:

6-MicroPak

Manufacturer:

onsemi

Product Status:

Active

Number of Elements:

1

Voltage - Supply, Single/Dual ( $\pm$ ):

1.6V ~ 5.5V,  $\pm$ 0.8V ~ 2.75V

Current - Input Bias (Max):

10pA @ 5.5V

Current - Quiescent (Max):

17 $\mu$ A

Propagation Delay (Max):

400ns (Typ)

Operating Temperature:

-40°C ~ 85°C

Mounting Type:

Surface Mount

Base Product Number:

FAN156

## Environmental & Export classification

RoHS Status:

ROHS3 Compliant

REACH Status:

REACH Unaffected

HTSUS:

8542.39.0001

Moisture Sensitivity Level (MSL):

1 (Unlimited)

ECCN:

EAR99

# Low Voltage Comparator

## FAN156



SIP6 1.45x1.0  
CASE 127EB

### Description

The FAN156 is a low-power single comparator that typically consumes less than 10  $\mu\text{A}$  of supply current. It is guaranteed to operate at a low voltage of 1.6 V and is fully operational up to 5.5 V, making it convenient for use in 1.8, 3.0 V, and 5.0 V systems.

The FAN156 has a complementary push-pull P- and N-channel output stage capable of driving a rail-to-rail output swing with a load ranging up to 5.0 mA.

### Features

- Low Supply Current:  $I_{DD}$  6  $\mu\text{A}$  (Typical)
- Single Power Supply Operation
- Wide Common-Mode Input Voltage Range
- Push-Pull Output Circuit
- Low Input Bias Current
- Internal Hysteresis
- Packaged in MicroPak™ 6
- This is a Pb-Free Device

### Applications

- Mobile Phones
- Alarm and Security Systems
- Personal Digital Assistants

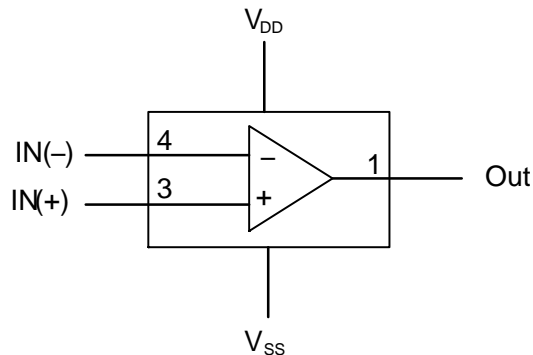
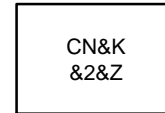

Figure 1. Functional Diagram

### MARKING DIAGRAM



CN = Specific Device Code  
 &K = 2-Digits Lot Run Traceability Code  
 &2 = 2-Digit Date Code  
 &Z = Assembly Plant Code

### ORDERING INFORMATION

See detailed ordering and shipping information on page 7 of this data sheet.

## FAN156

### PIN CONFIGURATION

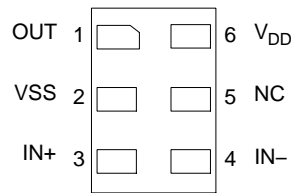

Figure 2. Pin Configuration (Top-Through View)

### PIN DEFINITIONS

Pin #	Name	Description
1	OUT	Comparator Output
2	$V_{SS}$	Negative Supply Voltage
3	IN+	Non-Inverting Input
4	IN-	Inverting Input
5	NC	No Connect
6	$V_{DD}$	Positive Supply Voltage

### FUNCTION TABLE

Inputs	Outputs
$IN(-) > IN(+)$	Output LOW
$IN(+ > IN(-)$	Output HIGH

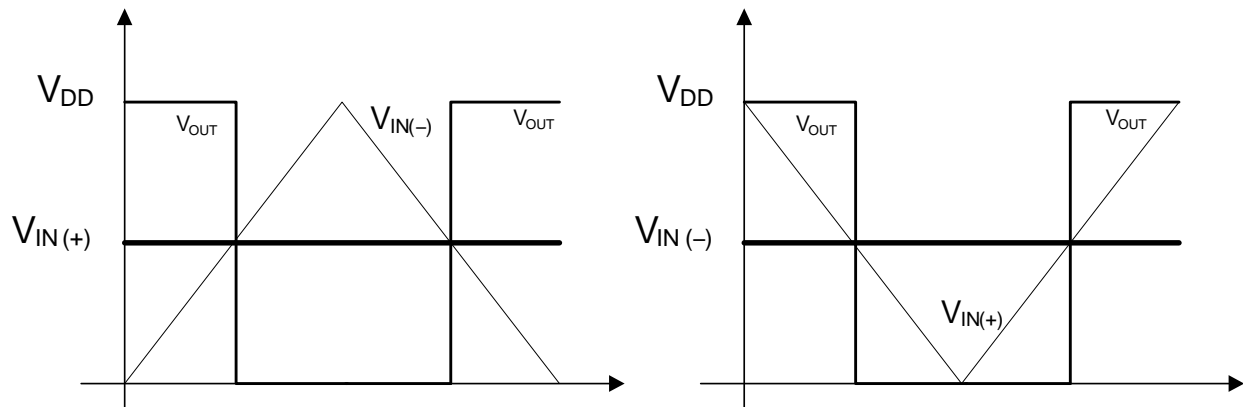

Figure 3.  $V_{IN}$  vs.  $V_{OUT}$

**FAN156****ABSOLUTE MAXIMUM RATINGS**

Symbol	Parameter	Condition	Min.	Max.	Unit
V <sub>DD</sub> to V <sub>SS</sub>	Supply Voltage		-3.0	+3.0	V
			0	6.0	
DV <sub>IN</sub>	Differential Input Voltage			±6	
V <sub>IN</sub>	Input Voltage			V <sub>SS</sub> to V <sub>DD</sub>	V
t <sub>s</sub>	Output Short Circuit Duration (Note 1)			Indefinite	s
T <sub>J</sub>	Junction Temperature			+150	°C
T <sub>STG</sub>	Storage Temperature Range		-65	+150	°C
P <sub>D</sub>	Power Dissipation			194	mW
θ <sub>JA</sub>	Thermal Resistance			335	°C/W
ESD	IEC 61000-4-2 System ESD	Air Gap		15	kV
		Contact		8	
	JEDEC JESD22-A114, Human Body Model	All Pins		8	
		Pin to Pin: IN(-), IN(+) to V <sub>DD</sub> or V <sub>SS</sub>		12	
	JEDEC JESD22-C101, Charged Device Model	All Pins		2	

Stresses exceeding those listed in the Maximum Ratings table may damage the device. If any of these limits are exceeded, device functionality should not be assumed, damage may occur and reliability may be affected.

1. The maximum total power dissipation must not be exceeded.

**RECOMMENDED OPERATING CONDITIONS**

Symbol	Parameter	Condition	Min.	Max.	Unit
V <sub>DD</sub> to V <sub>SS</sub>	Power Supply		-2.75	+2.75	V
			0	5.50	
V <sub>DD</sub>	Power Supply	V <sub>SS</sub> 0 V	1.6	5.5	V
V <sub>IN</sub>	Input Voltage			V <sub>SS</sub> to V <sub>DD</sub>	V
I <sub>OH</sub> /I <sub>OL</sub>	Output Sink/Source Current	V <sub>DD</sub> 5.0 V		5	mA
		V <sub>DD</sub> 3.0 V		3	
		V <sub>DD</sub> 1.6 V		1	
T <sub>A</sub>	Operating Temperature, Free Air		-40	+85	°C

Functional operation above the stresses listed in the Recommended Operating Ranges is not implied. Extended exposure to stresses beyond the Recommended Operating Ranges limits may affect device reliability.

## FAN156

## ELECTRICAL CHARACTERISTICS

Symbol	Parameter	Condition	Min.	Typ.	Max.	Unit
<b>V<sub>DD</sub> = 5.5 V, V<sub>SS</sub> = GND, and T<sub>A</sub> = +25°C</b>						
V <sub>HYS</sub>	Input Hysteresis	V <sub>CM</sub> = 0.5 V <sub>DD</sub>		4		mV
V <sub>IO</sub>	Input Offset Voltage (Note 2)	V <sub>CM</sub> = 0.5 V <sub>DD</sub>	-15	±1	+15	mV
I <sub>IO</sub>	Input Offset Current			10		pA
I <sub>I</sub>	Input Bias Current			10		pA
V <sub>CM</sub>	Common Mode Input Voltage		V <sub>SS</sub>		V <sub>DD</sub>	V
CMRR	Common Mode Rejection Ratio (Note 3)	V <sub>CM</sub> = V <sub>DD</sub>		68		dB
I <sub>DD</sub>	Supply Current			6	17	μA
PSRR	Power Supply Rejection Ratio (Note 3)	ΔV <sub>DD</sub> = 0.5 V	45	80		dB
I <sub>OS</sub>	Output Short Circuit Current	V <sub>O</sub> = V <sub>DD</sub>		60		mA
		V <sub>O</sub> = V <sub>SS</sub>		90		
V <sub>OL</sub>	Low-Level Output Voltage	I <sub>SINK</sub> = 5.0 mA		0.1	0.3	V
V <sub>OH</sub>	High-Level Output Voltage	I <sub>SOURCE</sub> = 5.0 mA	5.2	5.4		V
t <sub>PLH</sub>	Propagation Delay (Turn-On)	Overdrive 20 mV, C <sub>L</sub> = 15 pF		0.40		μs
t <sub>PHL</sub>	Propagation Delay (Turn-Off)	Overdrive = 20 mV, C <sub>L</sub> = 15 pF		0.42		μs
t <sub>TLH</sub>	Response Time, Output Rise/Fall (Note 4)	C <sub>L</sub> = 50 pF		4.0		ns
t <sub>THL</sub>				5.4		

**V<sub>DD</sub> = 3 V, V<sub>SS</sub> = GND, and T<sub>A</sub> = +25°C**

V <sub>HYS</sub>	Input Hysteresis	V <sub>CM</sub> = 0.5 V <sub>DD</sub>		4		mV
V <sub>IO</sub>	Input Offset Voltage (Note 2)	V <sub>CM</sub> = 0.5 V <sub>DD</sub>	-15	±1	+15	mV
I <sub>IO</sub>	Input Offset Current			10		pA
I <sub>I</sub>	Input Bias Current			10		pA
V <sub>CM</sub>	Common Mode Input Voltage		V <sub>SS</sub>		V <sub>DD</sub>	V
CMRR	Common Mode Rejection Ratio (Note 3)	V <sub>CM</sub> = V <sub>DD</sub>		60		dB
I <sub>DD</sub>	Supply Current			5.5	15.0	μA
PSRR	Power Supply Rejection Ratio (Note 3)	ΔV <sub>DD</sub> = 0.5 V	45	80		dB
I <sub>OS</sub>	Output Short Circuit Current	V <sub>O</sub> = V <sub>DD</sub>		27		mA
		V <sub>O</sub> = V <sub>SS</sub>		35		
V <sub>OL</sub>	Low-Level Output Voltage	I <sub>SINK</sub> = 3.0 mA		0.15	0.35	V
V <sub>OH</sub>	High-Level Output Voltage	I <sub>SOURCE</sub> = 3.0 mA	2.65	2.85		V
t <sub>PLH</sub>	Propagation Delay (Turn-On)	Overdrive = 20 mV, C <sub>L</sub> = 15 pF		0.45		μs
t <sub>PHL</sub>	Propagation Delay (Turn-Off)	Overdrive = 20 mV, C <sub>L</sub> = 15 pF		0.47		μs
t <sub>TLH</sub>	Response Time, Output Rise/Fall (Note 4)	C <sub>L</sub> = 50 pF		6.1		ns
t <sub>THL</sub>				6.2		

**V<sub>DD</sub> = 1.6 V, V<sub>SS</sub> = GND, and T<sub>A</sub> = +25°C**

V <sub>HYS</sub>	Input Hysteresis	V <sub>CM</sub> = 0.5 V <sub>DD</sub>		3.5		mV
V <sub>IO</sub>	Input Offset Voltage (Note 2)	V <sub>CM</sub> = 0.5 V <sub>DD</sub>	-15	±1	+15	mV
I <sub>IO</sub>	Input Offset Current			10		pA
I <sub>I</sub>	Input Bias Current			10		pA
V <sub>CM</sub>	Common Mode Input Voltage		V <sub>SS</sub>		V <sub>DD</sub>	V
CMRR	Common Mode Rejection Ratio (Note 3)	V <sub>CM</sub> = V <sub>DD</sub>		56		dB

**FAN156****ELECTRICAL CHARACTERISTICS** (continued)

Symbol	Parameter	Condition	Min.	Typ.	Max.	Unit
<b><math>V_{DD} = 1.6\text{ V}</math>, <math>V_{SS} = \text{GND}</math>, and <math>T_A = +25^\circ\text{C}</math></b>						
$I_{DD}$	Supply Current			5	15	$\mu\text{A}$
PSRR	Power Supply Rejection Ratio (Note 3)	$\Delta V_{DD} = 0.5\text{ V}$	45	80		dB
$I_{OS}$	Output Short Circuit Current	$V_O = V_{DD}$		5.5		mA
		$V_O = V_{SS}$		7.5		
$V_{OL}$	Low-Level Output Voltage	$I_{SINK} = 5.0\text{ mA}$		0.10	0.25	V
$V_{OH}$	High-Level Output Voltage	$I_{SOURCE} = 5.0\text{ mA}$	1.35	1.50		V
$t_{PLH}$	Propagation Delay (Turn-On)	Overdrive 20 mV, $C_L = 15\text{ pF}$		0.52		$\mu\text{s}$
$t_{PHL}$	Propagation Delay (Turn-Off)	Overdrive = 20 mV, $C_L = 15\text{ pF}$		0.54		$\mu\text{s}$
$t_{TLH}$	Response Time, Output Rise/Fall (Note 4)	$C_L = 50\text{ pF}$		16.5		ns
$t_{THL}$				13.0		

2. Differential input switching level is guaranteed at the minimum or maximum offset voltage, minus or plus half the maximum hysteresis voltage.

3. Guaranteed by design and characterization data.

4. Input signal: 1 kHz, square-wave signal with 10 ns edge rate.

# FAN156

## TYPICAL PERFORMANCE CHARACTERISTICS

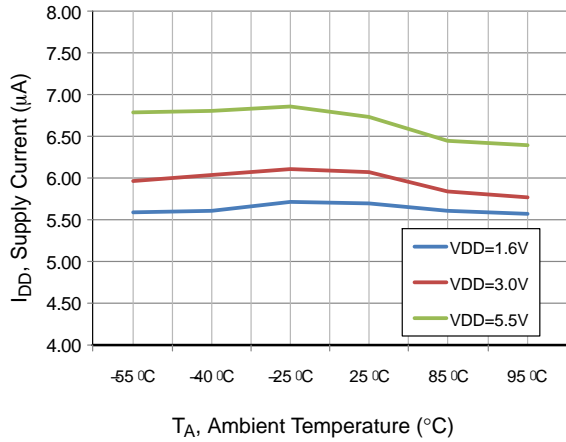

Figure 4. Supply Current vs. Temperature

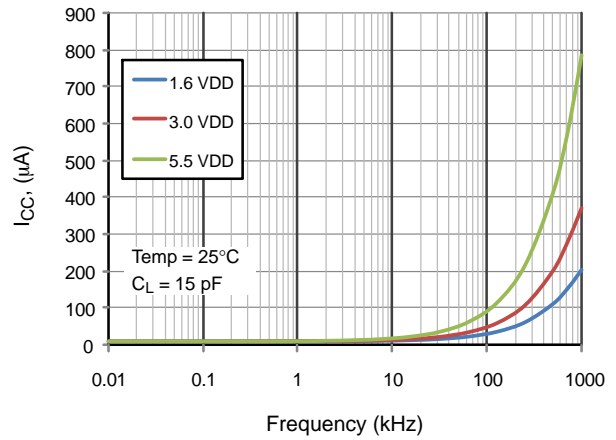

Figure 5. Supply Current vs. Output Transition Frequency

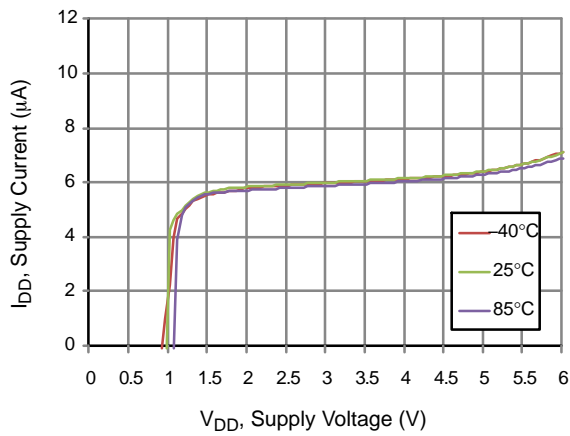

Figure 6. Supply Current vs. Supply Voltage

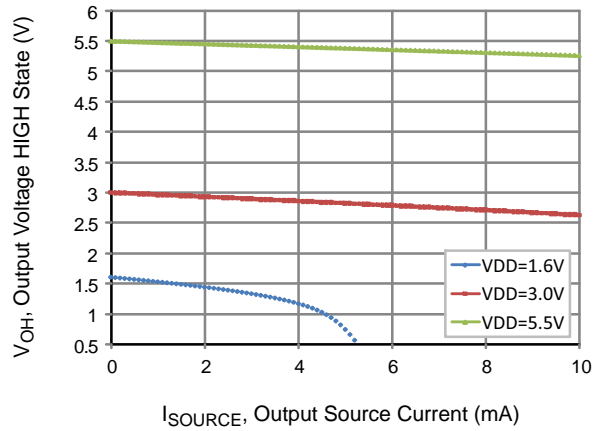

Figure 7. Output HIGH vs. Output Drive Current

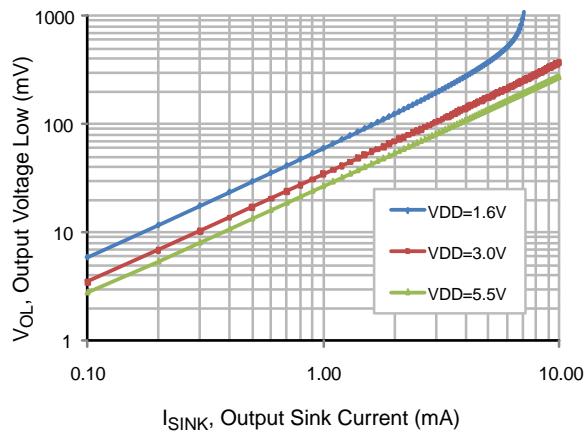

Figure 8. Output LOW vs. Output Drive Current

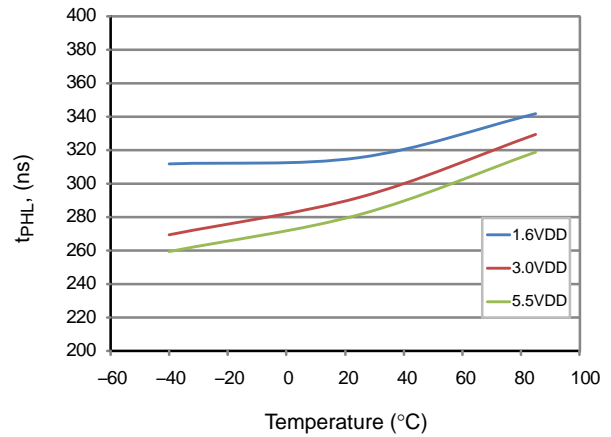
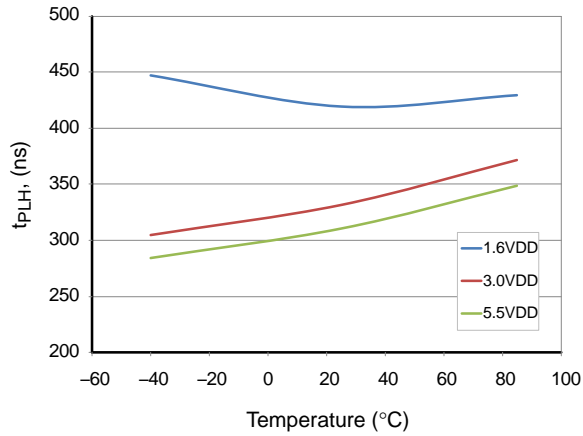

Figure 9. Propagation Delay  $t_{PHL}$  vs. Temperature



# FAN156

## TYPICAL PERFORMANCE CHARACTERISTICS (continued)



**Figure 10. Propagation Delay  $t_{(PLH)}$  vs. Temperature**

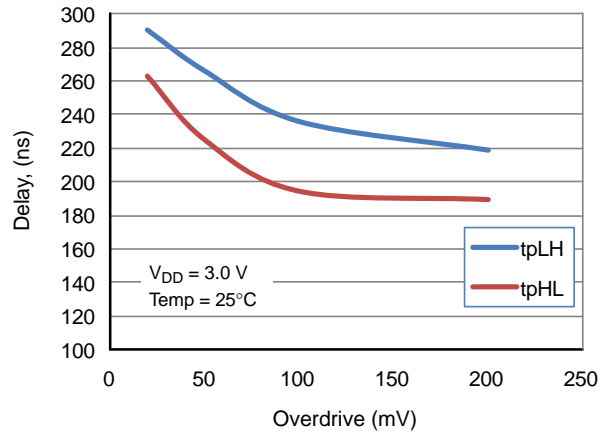

**Figure 11. Propagation Delay vs. Input Overdrive**

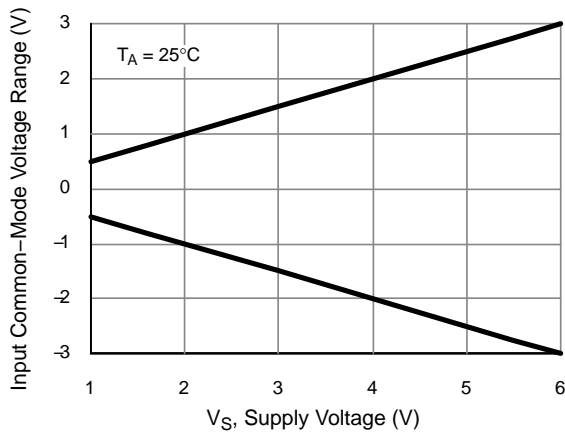

**Figure 12. Input Common-Mode Voltage Range vs. Supply Voltage**

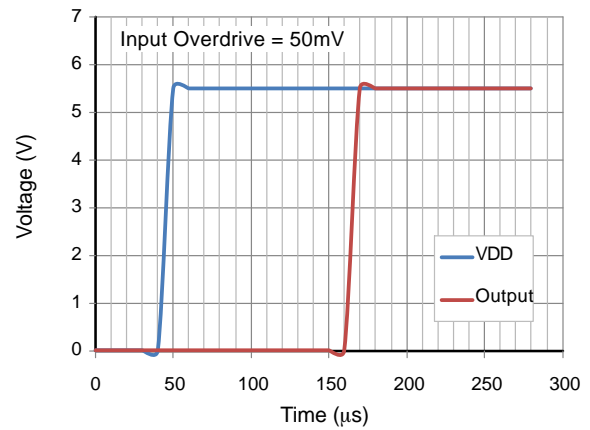

**Figure 13. Power-Up Delay**

### ORDERING INFORMATION

Device	Operating Temperature Range	Top Mark	Package	Shipping†
FAN156L6X	-40°C to +85°C	CN	6-Lead, SIP6 1.45x1.0 (MicroPak™) (Pb-Free)	5000 / Tape & Reel

†For information on tape and reel specifications, including part orientation and tape sizes, please refer to our Tape and Reel Packaging Specifications Brochure, BRD8011/D.

MicroPak is a trademark of Semiconductor Components Industries, LLC dba "onsemi" or its affiliates and/or subsidiaries in the United States and/or other countries.

**SIP6 1.45X1.0**  
CASE 127EB  
ISSUE O

DATE 31 AUG 2016

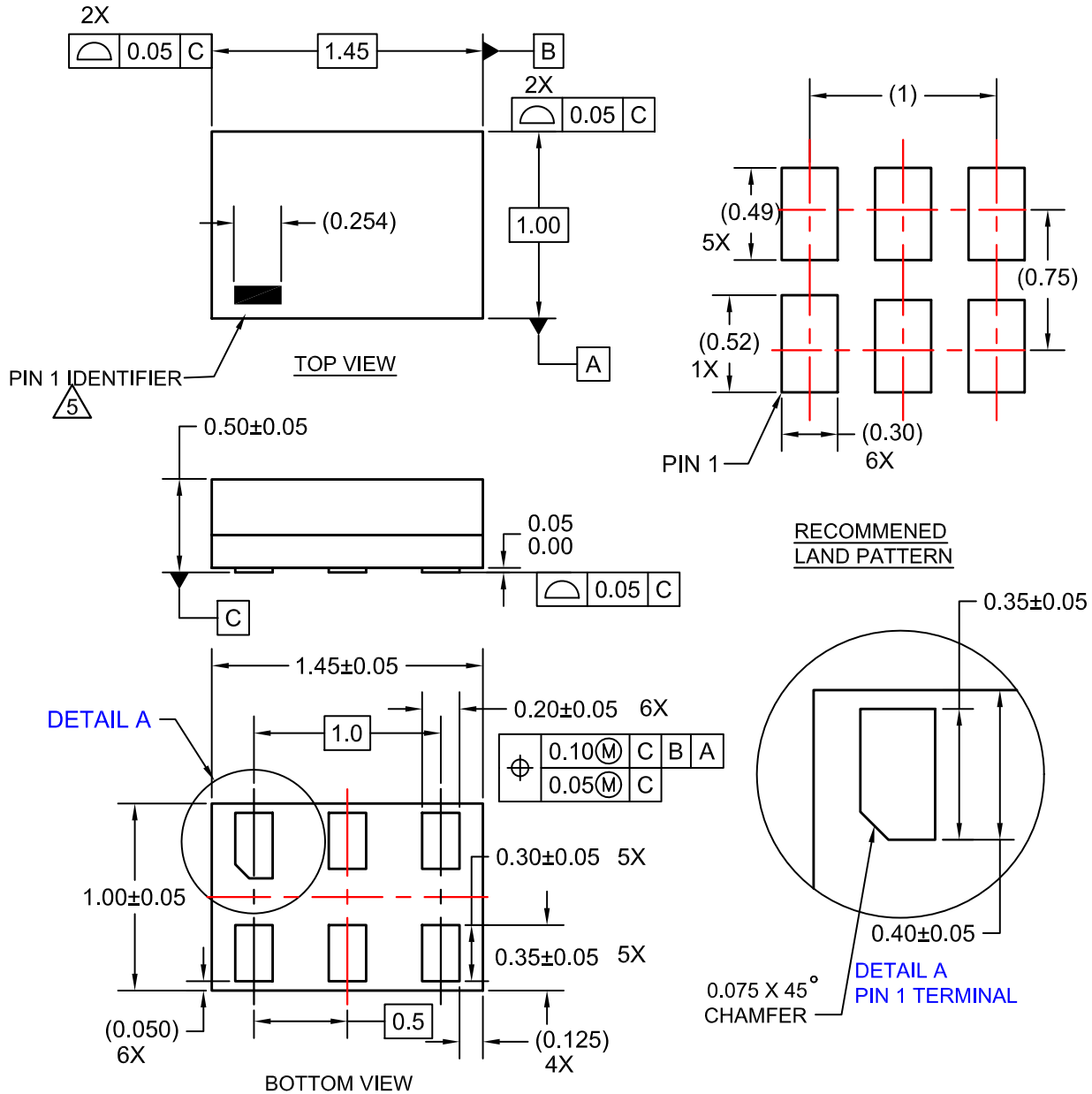

NOTES:

1. CONFORMS TO JEDEC STANDARD MO-252 VARIATION UAAD
2. DIMENSIONS ARE IN MILLIMETERS
3. DRAWING CONFORMS TO ASME Y14.5M-2009
4. PIN ONE IDENTIFIER IS 2X LENGTH OF ANY OTHER LINE IN THE MARK CODE LAYOUT.

<b>DOCUMENT NUMBER:</b>	<b>98AON13590G</b>	Electronic versions are uncontrolled except when accessed directly from the Document Repository. Printed versions are uncontrolled except when stamped "CONTROLLED COPY" in red.
<b>DESCRIPTION:</b>	<b>SIP6 1.45X1.0</b>	<b>PAGE 1 OF 1</b>

onsemi and ONSEMI are trademarks of Semiconductor Components Industries, LLC dba onsemi or its subsidiaries in the United States and/or other countries. onsemi reserves the right to make changes without further notice to any products herein. onsemi makes no warranty, representation or guarantee regarding the suitability of its products for any particular purpose, nor does onsemi assume any liability arising out of the application or use of any product or circuit, and specifically disclaims any and all liability, including without limitation special, consequential or incidental damages. onsemi does not convey any license under its patent rights nor the rights of others.

**onsemi**, **Onsemi**, and other names, marks, and brands are registered and/or common law trademarks of Semiconductor Components Industries, LLC dba "**onsemi**" or its affiliates and/or subsidiaries in the United States and/or other countries. **onsemi** owns the rights to a number of patents, trademarks, copyrights, trade secrets, and other intellectual property. A listing of **onsemi**'s product/patent coverage may be accessed at [www.onsemi.com/site/pdf/Patent-Marking.pdf](http://www.onsemi.com/site/pdf/Patent-Marking.pdf). **onsemi** reserves the right to make changes at any time to any products or information herein, without notice. The information herein is provided "as-is" and **onsemi** makes no warranty, representation or guarantee regarding the accuracy of the information, product features, availability, functionality, or suitability of its products for any particular purpose, nor does **onsemi** assume any liability arising out of the application or use of any product or circuit, and specifically disclaims any and all liability, including without limitation special, consequential or incidental damages. Buyer is responsible for its products and applications using **onsemi** products, including compliance with all laws, regulations and safety requirements or standards, regardless of any support or applications information provided by **onsemi**. "Typical" parameters which may be provided in **onsemi** data sheets and/or specifications can and do vary in different applications and actual performance may vary over time. All operating parameters, including "Typicals" must be validated for each customer application by customer's technical experts. **onsemi** does not convey any license under any of its intellectual property rights nor the rights of others. **onsemi** products are not designed, intended, or authorized for use as a critical component in life support systems or any FDA Class 3 medical devices or medical devices with a same or similar classification in a foreign jurisdiction or any devices intended for implantation in the human body. Should Buyer purchase or use **onsemi** products for any such unintended or unauthorized application, Buyer shall indemnify and hold **onsemi** and its officers, employees, subsidiaries, affiliates, and distributors harmless against all claims, costs, damages, and expenses, and reasonable attorney fees arising out of, directly or indirectly, any claim of personal injury or death associated with such unintended or unauthorized use, even if such claim alleges that **onsemi** was negligent regarding the design or manufacture of the part. **onsemi** is an Equal Opportunity/Affirmative Action Employer. This literature is subject to all applicable copyright laws and is not for resale in any manner.

#### ADDITIONAL INFORMATION

**TECHNICAL PUBLICATIONS:**

Technical Library: [www.onsemi.com/design/resources/technical-documentation](http://www.onsemi.com/design/resources/technical-documentation)  
onsemi Website: [www.onsemi.com](http://www.onsemi.com)

**ONLINE SUPPORT:** [www.onsemi.com/support](http://www.onsemi.com/support)

For additional information, please contact your local Sales Representative at [www.onsemi.com/support/sales](http://www.onsemi.com/support/sales)

## OUR CERTIFICATE

DiGi provide top-quality products and perfect service for customer worldwide through standardization, technological innovation and continuous improvement. DiGi through third-party certification, we stricly control the quality of products and services. Welcome your RFQ to

Email: [Info@DiGi-Electronics.com](mailto:Info@DiGi-Electronics.com)



Tel: +00 852-30501935

RFQ Email: [Info@DiGi-Electronics.com](mailto:Info@DiGi-Electronics.com)

DiGi is a global authorized distributor of electronic components.