

FAN48610UC50X Datasheet

www.digi-electronics.com

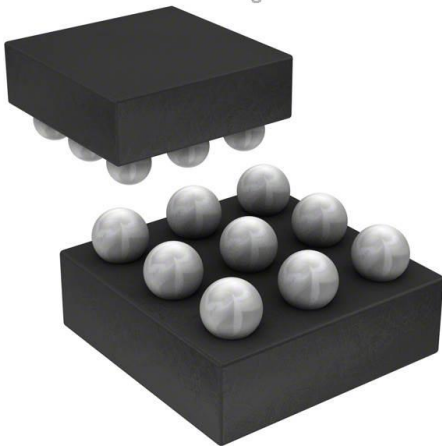

<https://www.DiGi-Electronics.com>

| | |
|------------------------------|--|
| DiGi Electronics Part Number | FAN48610UC50X-DG |
| Manufacturer | onsemi |
| Manufacturer Product Number | FAN48610UC50X |
| Description | IC REG BOOST 5V 1A 9WLCSP |
| Detailed Description | Boost Switching Regulator IC Positive Fixed 5V 1 Output 1A (Switch) 9-UFBGA, WLCSP |



Tel: +00 852-30501935

RFQ Email: Info@DiGi-Electronics.com

DiGi is a global authorized distributor of electronic components.

Purchase and inquiry

Manufacturer Product Number:

FAN48610UC50X

Series:

TinyBoost®

Function:

Step-Up

Topology:

Boost

Number of Outputs:

1

Voltage - Input (Max):

4.5V

Voltage - Output (Max):

-

Frequency - Switching:

2.5MHz

Operating Temperature:

-40°C ~ 85°C (TA)

Package / Case:

9-UFPGA, WLCSP

Base Product Number:

FAN48610

Manufacturer:

onsemi

Product Status:

Active

Output Configuration:

Positive

Output Type:

Fixed

Voltage - Input (Min):

2.5V

Voltage - Output (Min/Fixed):

5V

Current - Output:

1A (Switch)

Synchronous Rectifier:

Yes

Mounting Type:

Surface Mount

Supplier Device Package:

9-WLCSP (1.22x1.22)

Environmental & Export classification

RoHS Status:

ROHS3 Compliant

REACH Status:

REACH Unaffected

HTSUS:

8542.39.0001

Moisture Sensitivity Level (MSL):

1 (Unlimited)

ECCN:

EAR99

Fixed-Output Synchronous Regulator, TINYBOOST[®], 2.5 MHz

FAN48610



WLCSP9
CASE 567QW

MARKING DIAGRAM

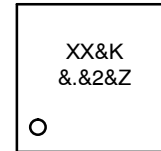

| | |
|----|--------------------------|
| XX | = KA / KF / KN |
| &K | = Lot Code |
| &. | = Alphabetical Year Code |
| &2 | = Numeric Date Code |
| &Z | = Assembly Plant Code |

Description

The FAN48610 is a low-power boost regulator designed to provide a minimum voltage-regulated rail from a standard single-cell Li-Ion battery and advanced battery chemistries. Even below the minimum system battery voltage, the device maintains the output voltage regulation for a minimum output load current of 1.0 A. The combination of built-in power transistors, synchronous rectification, and low supply current suit the FAN48610 for battery-powered applications.

The FAN48610 is available in a 9-bump, 0.4 mm pitch, Wafer-Level Chip-Scale Package (WLCSP).

Features

- Input Voltage Range: 2.5 V to 4.8 V
- Output Voltages Range: 3.0 V to 5.0 V
- $I_{OUT} \geq 1$ A at $V_{OUT} = 5.0$ V, $V_{IN} \geq 2.5$ V
- $I_{OUT} \geq 1.5$ A at $V_{OUT} = 5.0$ V, $V_{IN} \geq 3.0$ V
- Up to 94% Efficient
- Internal Synchronous Rectification
- Soft-Start with True Load Disconnect
- Short-Circuit Protection
- 9-Bump, 1.215 mm × 1.215 mm, 0.4 mm Pitch WLCSP
- Three External Components: 2016 0.47 μ H Inductor, 0603 Case Size Input / Output Capacitors
- Total Application Board Solution Size: < 11 mm²

Applications

- Class-D Audio Amplifier and USB OTG Supply
- Boost for Low-Voltage Li-Ion Batteries
- Smart Phones, Tablets, Portable Devices, Wearables

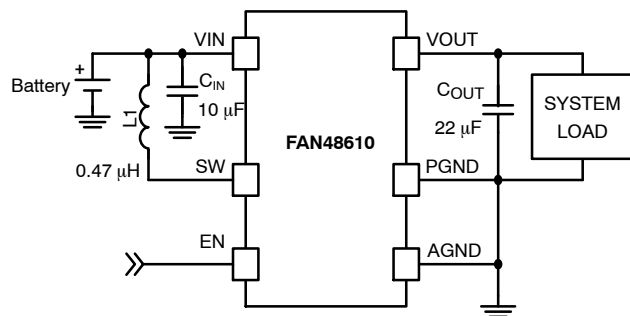

Figure 1. Typical Application

PIN ASSIGNMENT

| | | |
|------|------|------|
| VOUT | | VIN |
| (A1) | (A2) | (A3) |
| SW | | EN |
| (B1) | (B2) | (B3) |
| PGND | | AGND |
| (C1) | (C2) | (C3) |

(Top View)

ORDERING INFORMATION

See detailed ordering and shipping information on page 2 of this data sheet.

FAN48610**Table 1. ORDERING INFORMATION**

| Part Number | V _{OUT} | Operating Temperature | Package | Packing [†] | Device Marking |
|-------------------------|------------------|-----------------------|---------------------|----------------------|----------------|
| FAN48610UC50X | 5.0 V | -40°C to 85°C | WLCSP, 0.4 mm Pitch | Tape and Reel | KF |
| FAN48610BUC50X (Note 1) | | | | | |
| FAN48610BUC45X (Note 1) | 4.5 V | | | | KA |
| FAN48610BUC33X (Note 1) | 3.3 V | | | | KN |

[†]For information on tape and reel specifications, including part orientation and tape sizes, please refer to our Tape and Reel Packaging Specifications Brochure, BRD8011/D.

1. Includes backside lamination.

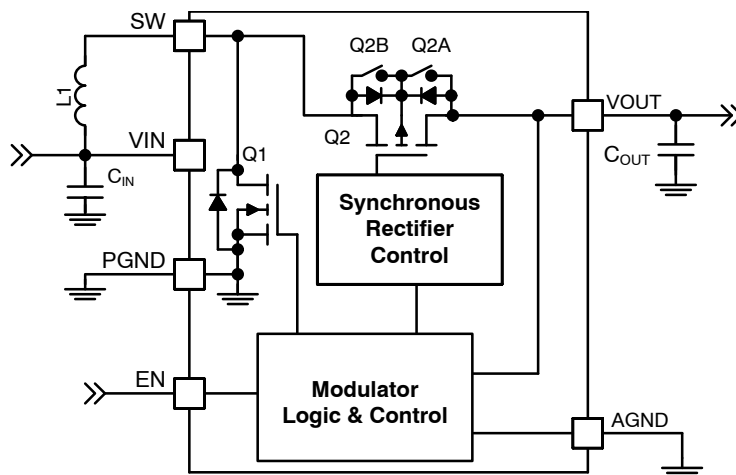
BLOCK DIAGRAM**Figure 2. IC Block Diagram****Table 2. RECOMMENDED COMPONENTS**

| Component | Description | Ventor | Parameter | Typ. | Unit |
|------------------|-----------------------------------|---|----------------|------|------------|
| L1 | 0.47 μ H, 30%, 2016 | Toko: DFE201612C DFR201612C Cyntec: PIFE20161B | L | 0.47 | μ H |
| | | | DCR (Series R) | 40 | m Ω |
| C _{IN} | 10 μ F, 10%, 6.3 V, X5R, 0603 | Murata: GRM188R60J106K TDK: C1608X5R0J106K | C | 10 | μ F |
| C _{OUT} | 22 μ F, 20%, 6.3 V, X5R, 0603 | TDK: C1608X5R0J226M | C | 22 | μ F |

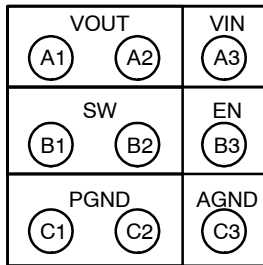
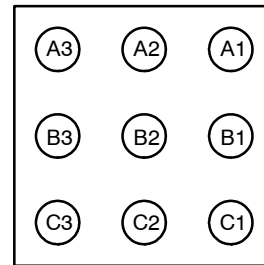
FAN48610**PIN CONFIGURATION****Figure 3. Top View****Figure 4. Bottom View****Table 3. PIN DEFINITIONS**

| Pin # | Name | Description |
|--------|------|---|
| A1, A2 | VOUT | Output Voltage. This pin is the output voltage terminal; connect directly to C _{OUT} . |
| A3 | VIN | Input Voltage. Connect to Li-Ion battery input power source and the bias supply for the gate drivers. |
| B1, B2 | SW | Switching Node. Connect to inductor. |
| B3 | EN | Enable. When this pin is HIGH, the circuit is enabled. |
| C1, C2 | PGND | Power Ground. This is the power return for the IC. C _{OUT} capacitor should be returned with the shortest path possible to these pins. |
| C3 | AGND | Analog Ground. This is the signal ground reference for the IC. All voltage levels are measured with respect to this pin – connect to PGND at a single point. |

Table 4. ABSOLUTE MAXIMUM RATINGS

| Symbol | Parameter | | Min. | Max. | Unit |
|------------------|--|--------------------------------------|------|-----------------|------|
| V _{IN} | Voltage on VIN Pin | | -0.3 | 6.0 | V |
| V _{OUT} | Voltage on VOUT Pin | | -0.3 | 6.0 | V |
| SW | SW Node | DC | -0.3 | 6.0 | V |
| | | Transient: 10 ns, 3 MHz | -1.0 | 8.0 | |
| V _{CC} | Voltage on Other Pins | | -0.3 | 6.0 (Note 2) | V |
| ESD | Electrostatic Discharge Protection Level | Human Body Model per JESD22-A114 | 2 | | kV |
| | | Charged Device Model per JESD22-C101 | 1 | | |
| T _J | Junction Temperature | | -40 | +150 | °C |
| T _{STG} | Storage Temperature | | -65 | +150 | °C |
| T _L | Lead Soldering Temperature, 10 Seconds | | | +260 | °C |

Stresses exceeding those listed in the Maximum Ratings table may damage the device. If any of these limits are exceeded, device functionality should not be assumed, damage may occur and reliability may be affected.

2. Lesser of 6.0 V or V_{IN} + 0.3 V.

FAN48610**Table 5. RECOMMENDED OPERATING CONDITIONS**

| Symbol | Parameter | Min. | Max. | Unit |
|------------------|------------------------|------|------|------|
| V _{IN} | Supply Voltage | 2.5 | 4.8 | V |
| I _{OUT} | Maximum Output Current | 1000 | | mA |
| T _A | Ambient Temperature | -40 | +85 | °C |
| T _J | Junction Temperature | -40 | +125 | °C |

Functional operation above the stresses listed in the Recommended Operating Ranges is not implied. Extended exposure to stresses beyond the Recommended Operating Ranges limits may affect device reliability.

Table 6. THERMAL PROPERTIES

| Symbol | Parameter | Typical | Unit |
|-----------------|--|---------|------|
| θ _{JA} | Junction-to-Ambient Thermal Resistance | 50 | °C/W |

Junction-to-ambient thermal resistance is a function of application and board layout. This data is measured with four-layer 2s2p boards in accordance to JEDEC standard JESD51. Special attention must be paid not to exceed junction temperature T_{J(max)} at a given ambient temperature T_A.

Table 7. ELECTRICAL CHARACTERISTICS

(Recommended operating conditions, unless otherwise noted, circuit per Figure 1, V_{OUT} = 3.0 V to 5.0 V, V_{IN} = 2.5 V to 4.5 V, T_A = -40°C to 85°C. Typical values are given V_{IN} = 3.6 V and T_A = 25°C)

| Symbol | Parameter | Conditions | Min. | Typ. | Max. | Unit |
|--------|-----------|------------|------|------|------|------|
|--------|-----------|------------|------|------|------|------|

POWER SUPPLY

| | | | | | | |
|-----------------------|-----------------------------------|---|--|-----|-----|----|
| I _Q | V _{IN} Quiescent Current | V _{IN} = 3.6 V, I _{OUT} = 0 A, EN = V _{IN} | | 85 | 125 | μA |
| | | Shutdown: EN = 0, V _{IN} = 3.6 V | | 3 | 10 | |
| V _{UVLO} | Under-Voltage Lockout | V _{IN} Rising | | 2.2 | 2.3 | V |
| V _{UVLO_HYS} | Under-Voltage Lockout Hysteresis | | | 150 | | mV |

INPUTS

| | | | | | | |
|------------------|----------------------------|--------------------|------|-----|-----|----|
| V _{IH} | Enable HIGH Voltage | | 1.05 | | | V |
| V _{IL} | Enable LOW Voltage | | | | 0.4 | V |
| I _{PD} | Current Sink Pull-Down | EN Pin, Logic HIGH | | 100 | | nA |
| R _{LOW} | Low-State Active Pull-Down | EN Pin, Logic LOW | 200 | 300 | 400 | kΩ |

OUTPUTS

| | | | | | | |
|---------------------|--|---|----|--|-----|----|
| V _{REG} | Output Voltage Accuracy DC (Note 3) | Referred to V _{OUT} , 2.5 V ≤ V _{IN} ≤ V _{OUT} - 150 mV | -2 | | 4 | % |
| I _{LK_OUT} | VIN-to-VOUT Leakage Current | V _{OUT} = 0, EN = 0, V _{IN} = 4.2 V | | | 1 | μA |
| I _{LK} | VOUT-to-VIN Reverse Leakage Current | V _{OUT} = 5.0 V, EN = 0, V _{IN} = 2.5 V | | | 3.5 | μA |
| V _{TRSP} | Output Voltage Accuracy Transient (Note 4) | Referred to V _{OUT} , 50–500 mA Load Step | -5 | | 5 | % |

TIMING

| | | | | | | |
|------------------|---|---|-----|-----|-----|-----|
| f _{SW} | Switching Frequency | V _{IN} = 3.6 V, V _{OUT} = 5.0 V, Load = 1000 mA | 2.0 | 2.5 | 3.0 | MHz |
| t _{SS} | Soft-Start EN HIGH to Regulation (Note 4) | 50 Ω Load, V _{OUT} = 5.0 V | | 600 | | μA |
| t _{RST} | FAULT Restart Timer (Note 4) | | | 20 | | ms |

FAN48610**Table 7. ELECTRICAL CHARACTERISTICS** (continued)

(Recommended operating conditions, unless otherwise noted, circuit per Figure 1, V_{OUT} = 3.0 V to 5.0 V, V_{IN} = 2.5 V to 4.5 V, T_A = -40°C to 85°C . Typical values are given V_{IN} = 3.6 V and T_A = 25°C)

| Symbol | Parameter | Conditions | Min. | Typ. | Max. | Unit |
|----------------------|--|--|------|------|------|--------------------|
| POWER STAGE | | | | | | |
| $R_{DS(ON)N}$ | N-Channel Boost Switch $R_{DS(ON)}$ | $V_{IN} = 3.6\text{ V}$, $V_{OUT} = 5.0\text{ V}$ | | 80 | 130 | $\text{m}\Omega$ |
| $R_{DS(ON)P}$ | P-Channel Sync. Rectifier $R_{DS(ON)}$ | $V_{IN} = 3.6\text{ V}$, $V_{OUT} = 5.0\text{ V}$ | | 65 | 115 | $\text{m}\Omega$ |
| $I_V\text{LIM}$ | Boost Valley Current Limit | $V_{OUT} = 5.0\text{ V}$ | | 3.00 | 3.85 | A |
| $I_V\text{LIM}_{SS}$ | Boost Soft-Start Valley Current Limit | $V_{IN} < V_{OUT} < V_{OUT_TARGET}$, SS Mode | | 1.7 | | A |
| $V_{MIN_1.0A}$ | Minimum V_{IN} for 1000 mA Load (Note 4) | $V_{OUT} = 5.0\text{ V}$ | | 2.5 | | V |
| $V_{MIN_1.5A}$ | Minimum V_{IN} for 1500 mA Load (Note 4) | $V_{OUT} = 5.0\text{ V}$ | | 3.0 | | V |
| T_{150T} | Over-Temperature Protection (OTP) | | | 150 | | $^{\circ}\text{C}$ |
| T_{150H} | OTP Hysteresis | | | 20 | | $^{\circ}\text{C}$ |

Product parametric performance is indicated in the Electrical Characteristics for the listed test conditions, unless otherwise noted. Product performance may not be indicated by the Electrical Characteristics if operated under different conditions.

3. DC I_{LOAD} from 0 to 1 A. V_{OUT} measured from mid-point of output voltage ripple. Effective capacitance of $C_{OUT} \geq 3\ \mu\text{F}$.

4. Guaranteed by design and characterization; not tested in production.

FAN48610

TYPICAL CHARACTERISTICS

(Unless otherwise specified; $V_{IN} = 3.6\text{ V}$, $V_{OUT} = 5.0\text{ V}$, $T_A = 25^\circ\text{C}$, and circuit and components according to Figure 1)

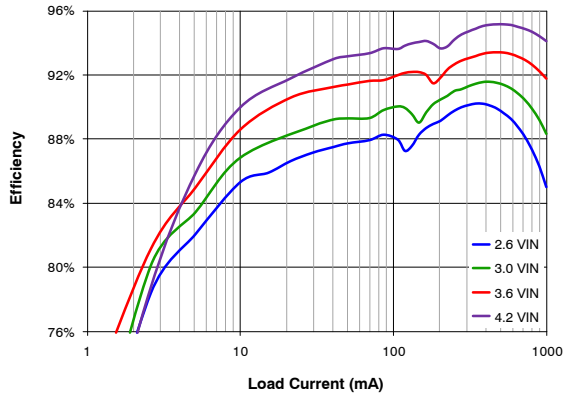

Figure 5. Efficiency vs. Load Current and Input Voltage

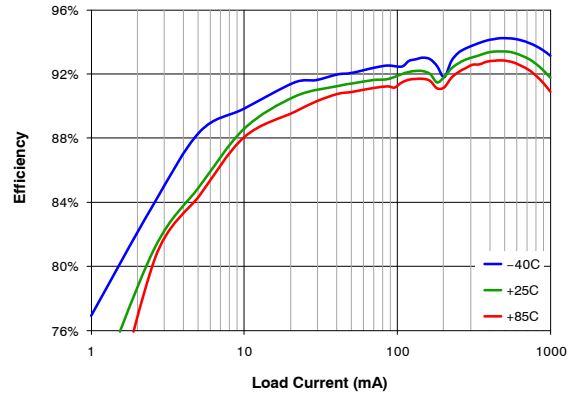

Figure 6. Efficiency vs. Load Current and Temperature

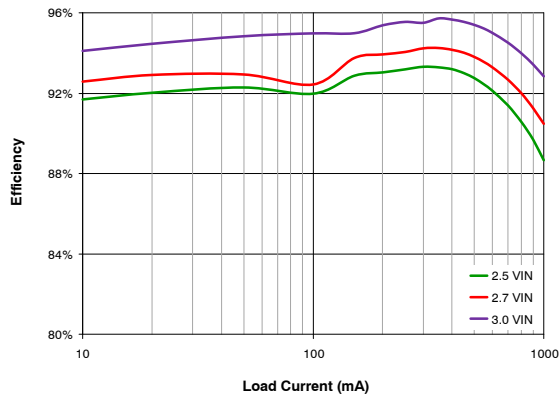

Figure 7. Efficiency vs. Load Current and Input Voltage, $V_{OUT} = 3.3\text{ V}$

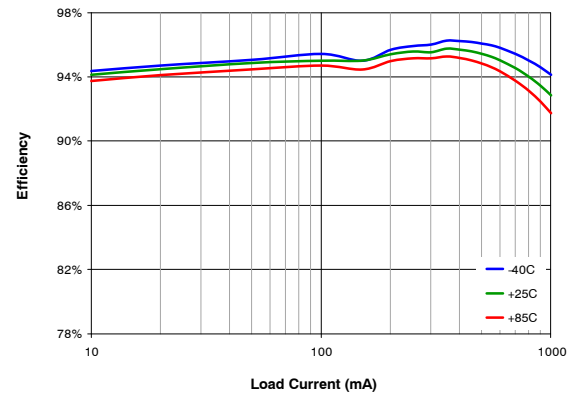

Figure 8. Efficiency vs. Load Current and Temperature, $V_{IN} = 3.0\text{ V}$, $V_{OUT} = 3.3\text{ V}$

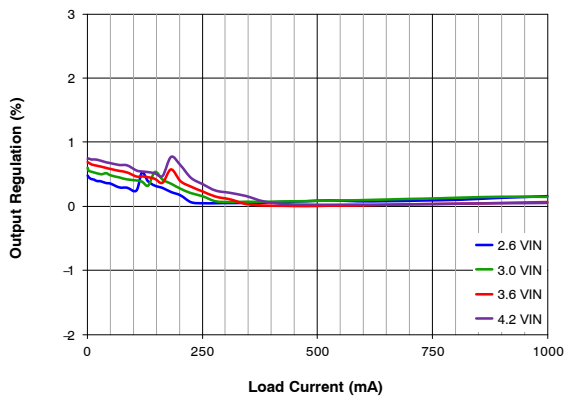

Figure 9. Output Regulation vs. Load Current and Input Voltage (Normalized to 3.6 V_{IN} , 500 mA Load)

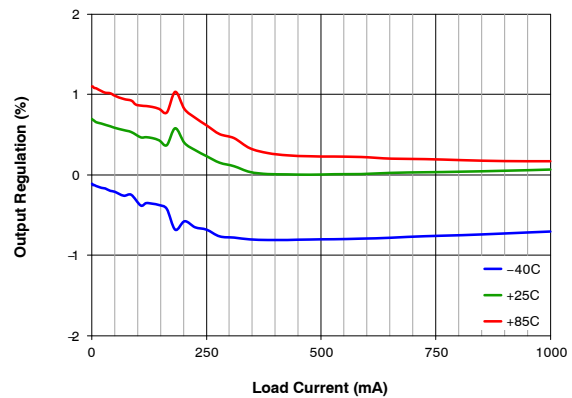

Figure 10. Output Regulation vs. Load Current and Temperature (Normalized to 3.6 V_{IN} , 500 mA Load, $T_A = 25^\circ\text{C}$)

FAN48610

TYPICAL CHARACTERISTICS

(Unless otherwise specified; $V_{IN} = 3.6\text{ V}$, $V_{OUT} = 5.0\text{ V}$, $T_A = 25^\circ\text{C}$, and circuit and components according to Figure 1)

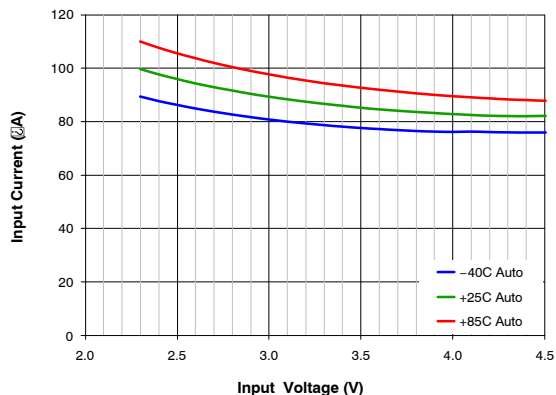

Figure 11. Quiescent Current vs. Input Voltage, Temperature

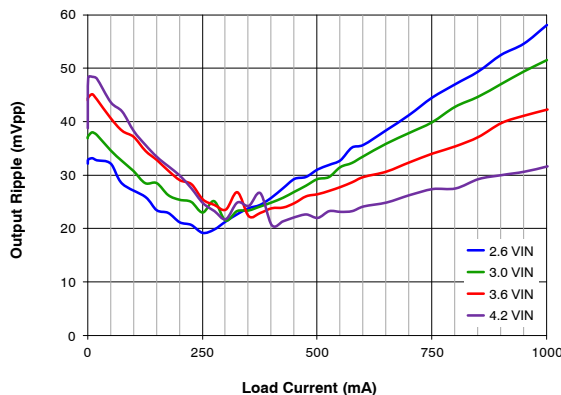

Figure 12. Output Ripple vs. Load Current and Input Voltage

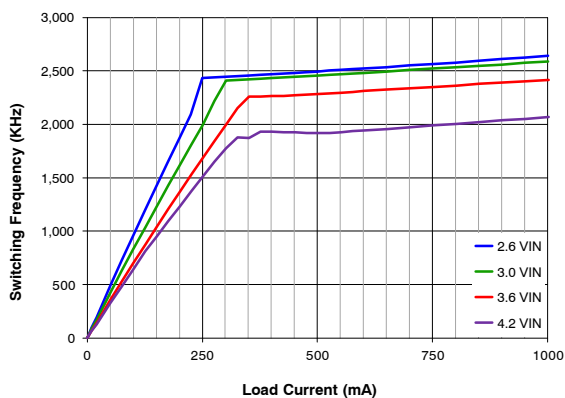

Figure 13. Frequency vs. Load Current and Input Voltage

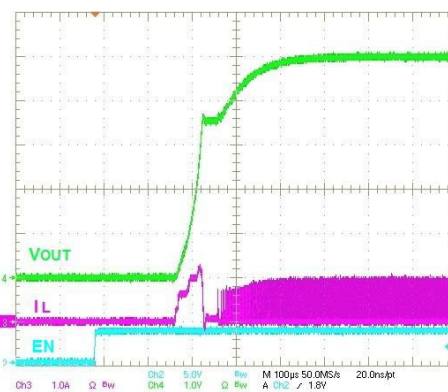

Figure 14. Startup, 50 Ω Load

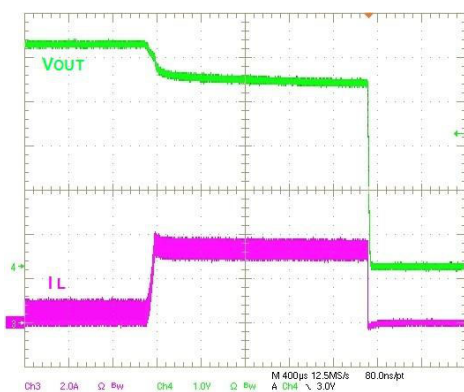

Figure 15. Overload Protection

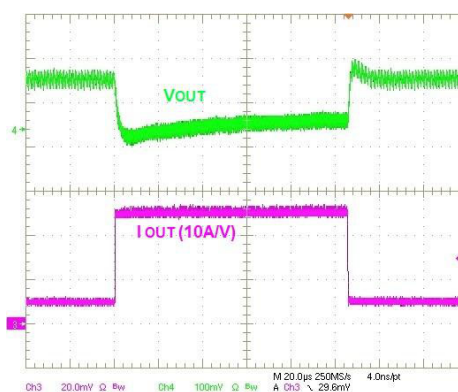

Figure 16. Load Transient, 100–500 mA, 100 ns Edge

FAN48610

TYPICAL CHARACTERISTICS

(Unless otherwise specified; $V_{IN} = 3.6\text{ V}$, $V_{OUT} = 5.0\text{ V}$, $T_A = 25^\circ\text{C}$, and circuit and components according to Figure 1)

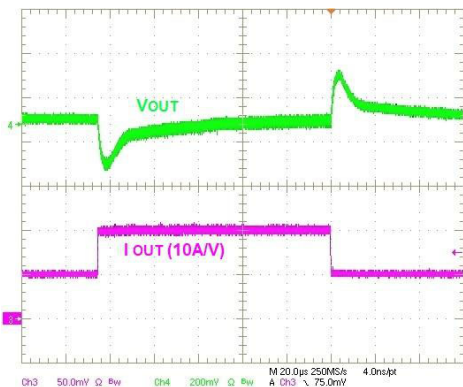

Figure 17. Load Transient, 500–1000 mA, 100 ns Edge

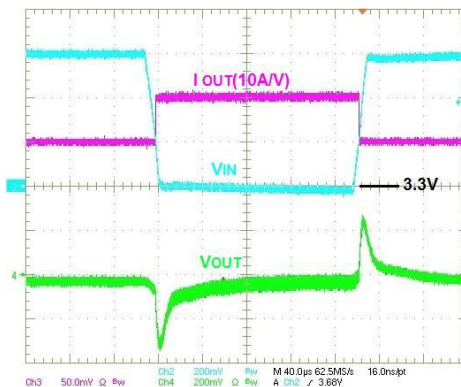

Figure 18. Simultaneous Line / Load Transient, 3.3 –3.9 V_{IN} , 10 μs Edge, 500–1000 mA Load, 100 ns Edge

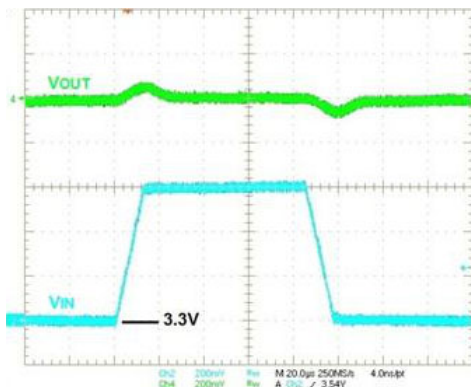

Figure 19. Line Transient, 3.3–3.9 V_{IN} , 10 μs Edge, 500 mA Load

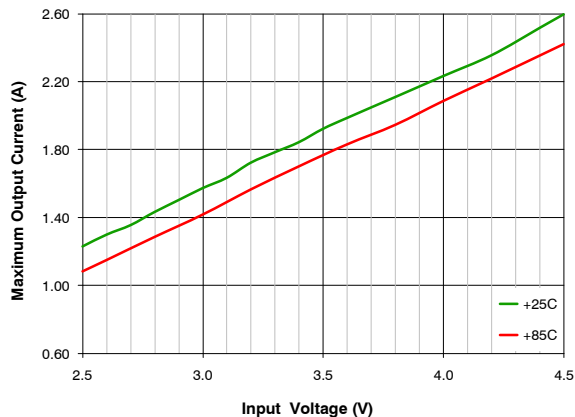

Figure 20. Typical Maximum Output Current vs. Input Voltage

FAN48610

CIRCUIT DESCRIPTION

FAN48610 is a synchronous boost regulator, typically operating at 2.5 MHz in Continuous Conduction Mode (CCM), which occurs at moderate to heavy load current and low V_{IN} voltages. The regulator's Pass-Through Mode automatically activates when V_{IN} is above the boost regulator's set point.

Table 8. OPERATING MODES

| Mode | Description | Invoked When: |
|------|----------------------|--------------------------------------|
| LIN | Linear Startup | $V_{IN} > V_{OUT}$ |
| SS | Boost Soft-Start | $V_{IN} < V_{OUT} < V_{OUT(TARGET)}$ |
| BST | Boost Operating Mode | $V_{OUT} = V_{OUT(TARGET)}$ |
| PT | Pass-Through Mode | $V_{IN} > V_{OUT(TARGET)}$ |

Table 9. BOOST STARTUP SEQUENCE

| Start Mode | Entry | Exit | End Mode | Timeout (μ s) |
|------------|------------------------------|-----------------------------|----------|--------------------|
| LIN1 | $V_{IN} > V_{UVLO}$, EN = 1 | $V_{OUT} > V_{IN} - 300$ mV | SS | |
| | | TIMEOUT | LIN2 | 512 |
| LIN2 | LIN1 Exit | $V_{OUT} > V_{IN} - 300$ mV | SS | |
| | | TIMEOUT | FAULT | 1024 |
| SS | LIN1 or LIN2 Exit | $V_{OUT} = V_{OUT(TARGET)}$ | BST | |
| | | OVERLOAD TIMEOUT | FAULT | 64 |

LIN Mode

When EN is HIGH and $V_{IN} > V_{UVLO}$, the regulator first attempts to bring V_{OUT} within 300 mV of V_{IN} by using the internal fixed-current source from V_{IN} (Q2). The current is limited to the LIN1 set point.

If V_{OUT} reaches $V_{IN} - 300$ mV during LIN1 Mode, the SS Mode is initiated. Otherwise, LIN1 times out after 512 μ s and LIN2 Mode is entered.

In LIN2 Mode, the current source is incremented to 1.6 A. If V_{OUT} fails to reach $V_{IN} - 300$ mV after 1024 μ s, a fault condition is declared and the device waits 20 ms to attempt an automatic restart.

Soft-Start (SS) Mode

Upon the successful completion of LIN Mode ($V_{OUT} \geq V_{IN} - 300$ mV), the regulator begins switching with boost pulses current limited to 50% of nominal level.

During SS Mode, if V_{OUT} fails to reach regulation during the SS ramp sequence for more than 64 μ s, a fault is declared. If large C_{OUT} is used, the reference is automatically stepped slower to avoid excessive input current draw.

Boost (BST) Mode

This is a normal operating mode of the regulator.

Boost Mode Regulation

The FAN48610 uses a current-mode modulator to achieve excellent transient response and smooth transitions between CCM and DCM operation. During CCM operation, the device maintains a switching frequency of about 2.5 MHz. In lightload operation (DCM), frequency is naturally reduced to maintain high efficiency.

Shutdown and Startup

When EN is LOW, all bias circuits are off and the regulator is in Shutdown Mode. During shutdown, current flow is prevented from V_{IN} to V_{OUT} , as well as reverse flow from V_{OUT} to V_{IN} . It is recommended to keep load current draw below 500 mA until the devices successfully executes startup. The following table describes the startup sequence.

Pass-Through (PT) Mode

In normal operation, the device automatically transitions from Boost Mode to Pass-Through Mode if V_{IN} goes above the target V_{OUT} . In Pass-Through Mode, the device fully enhances Q2 to provide a very low impedance path from V_{IN} to V_{OUT} . Entry to the Pass-Through Mode is triggered by condition where $V_{IN} > V_{OUT}$ and no switching has occurred during the past 5 μ s. To soften the entry into Pass-Through Mode, Q2 is driven as a linear current source for the first 5 μ s. Pass-Through Mode exit is triggered when V_{OUT} reaches the target V_{OUT} voltage. During Automatic Pass-Through Mode, the device is short-circuit protected by a voltage comparator tracking the voltage drop from V_{IN} to V_{OUT} ; if the drop exceeds 300 mV, a fault is declared.

Fault State

The regulator enters Fault State under any of the following conditions:

- V_{OUT} fails to achieve the voltage required to advance from LIN Mode to SS Mode.
- V_{OUT} fails to achieve the voltage required to advance from SS Mode to BST Mode.
- Boost current limit triggers for 2 ms during BST Mode.

FAN48610

- $V_{IN} - V_{OUT} > 300$ mV; this fault can occur only after successful completion of the soft-start sequence.
- $V_{IN} < V_{UVLO}$.

Once a fault is triggered, the regulator stops switching and presents a high-impedance path between VIN and VOUT. After waiting 20 ms, an automatic restart is attempted.

APPLICATION INFORMATION

Output Capacitance (C_{OUT})

The effective capacitance (C_{EFF} (Note 5)) of small, high-value ceramic capacitors decreases as their bias voltage increases, as illustrated in the graph below:

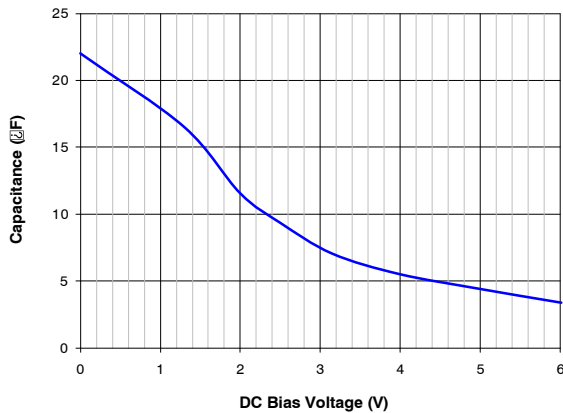

Figure 21. C_{EFF} for 22 μ F, 0603, X5R, 6.3 V-Rated Capacitor (TDK C1608X5R0J226M)

FAN48610 is guaranteed for stable operation with the minimum value of C_{EFF} ($C_{EFF(MIN)}$) outlined in Table 10.

Table 10. MINIMUM C_{EFF} REQUIRED FOR STABILITY

| Operating Conditions | | | $C_{EFF(MIN)}$ (μ F) |
|----------------------|--------------|-----------------|------------------------------|
| V_{OUT} (V) | V_{IN} (V) | I_{LOAD} (mA) | |
| 5.0 | 2.5 to 4.5 | 0 to 1000 | 3.0 |

5. C_{EFF} varies by manufacturer, capacitor material, and case size.

Introduction Selection

Recommended nominal inductance value is 0.47 μ H. The FAN48610 employs valley-current limiting, so peak inductor current can reach 3.8 A for a short duration during overload conditions. Saturation effects cause the inductor current ripple to become higher under high loading, as only the valley of the inductor current ripple is controlled.

Startup

Input current limiting is in effect during soft-start, which limits the current available to charge C_{OUT} and any

Over-Temperature

The regulator shuts down if the die temperature exceeds 150°C. Restart occurs when the IC has cooled by approximately 20°C.

additional capacitance on the V_{OUT} line. If the output fails to achieve regulation within the limits described in the Soft-Start section above, a fault occurs, causing the circuit to shut down. It waits about 20 ms before attempting a restart. If the total combined output capacitance is very high, the circuit may not start on the first attempt, but eventually achieves regulation if no load is present. If a high current load and high capacitance are both present during soft-start, the circuit may fail to achieve regulation and continually attempt soft-start, only to have the output capacitance discharged by the load when in Fault State.

Output Voltage Ripple

Output voltage ripple is inversely proportional to C_{OUT} . During t_{ON} , when the boost switch is on, all load current is supplied by C_{OUT} .

$$V_{RIPPLE(P-P)} = t_{ON} \cdot \frac{I_{LOAD}}{C_{OUT}} \quad (\text{eq. 1})$$

And

$$t_{ON} = t_{SW} \cdot D = t_{SW} \cdot \left(1 - \frac{V_{IN}}{V_{OUT}}\right) \quad (\text{eq. 2})$$

therefore:

$$V_{RIPPLE(P-P)} = t_{SW} \cdot \left(1 - \frac{V_{IN}}{V_{OUT}}\right) \cdot \frac{I_{LOAD}}{C_{OUT}} \quad (\text{eq. 3})$$

$$t_{SW} = \frac{1}{f_{SW}} \quad (\text{eq. 4})$$

The maximum V_{RIPPLE} occurs when V_{IN} is minimum and I_{LOAD} is maximum. For better ripple performance, more output capacitance can be added.

Layout Recommendations

The layout recommendations below highlight various topcopper pours by using different colors.

To minimize spikes at VOUT, C_{OUT} must be placed as close as possible to PGND and VOUT, as shown below.

For thermal reasons, it is suggested to maximize the pour area for all planes other than SW. Especially the ground pour should be set to fill all available PCB surface area and tied to internal layers with a cluster of thermal vias.

FAN48610

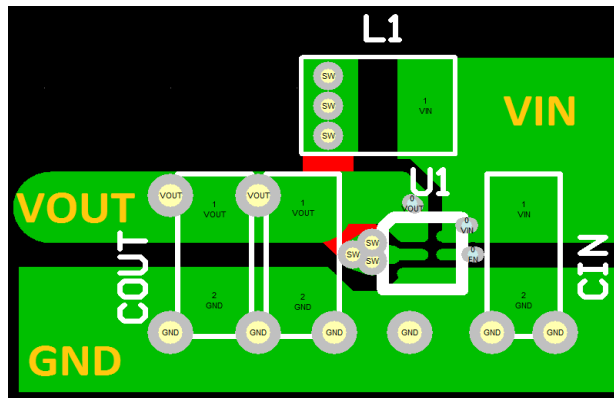

Figure 22. Layout Recommendation

PRODUCT-SPECIFIC DIMENSIONS (This table pertains to the package information on the following page.)

| D | E | X | Y |
|-----------------|-----------------|-----------|-----------|
| 1.215 ±0.030 mm | 1.215 ±0.030 mm | 0.2075 mm | 0.2075 mm |

TINYBOOST is a registered trademark of Semiconductor Components Industries, LLC (SCILLC) or its subsidiaries in the United States and/or other countries.



**MECHANICAL CASE OUTLINE
PACKAGE DIMENSIONS**

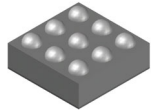

**WLCSP9 1.215x1.215x0.581
CASE 567QW
ISSUE B**

DATE 24 FEB 2023

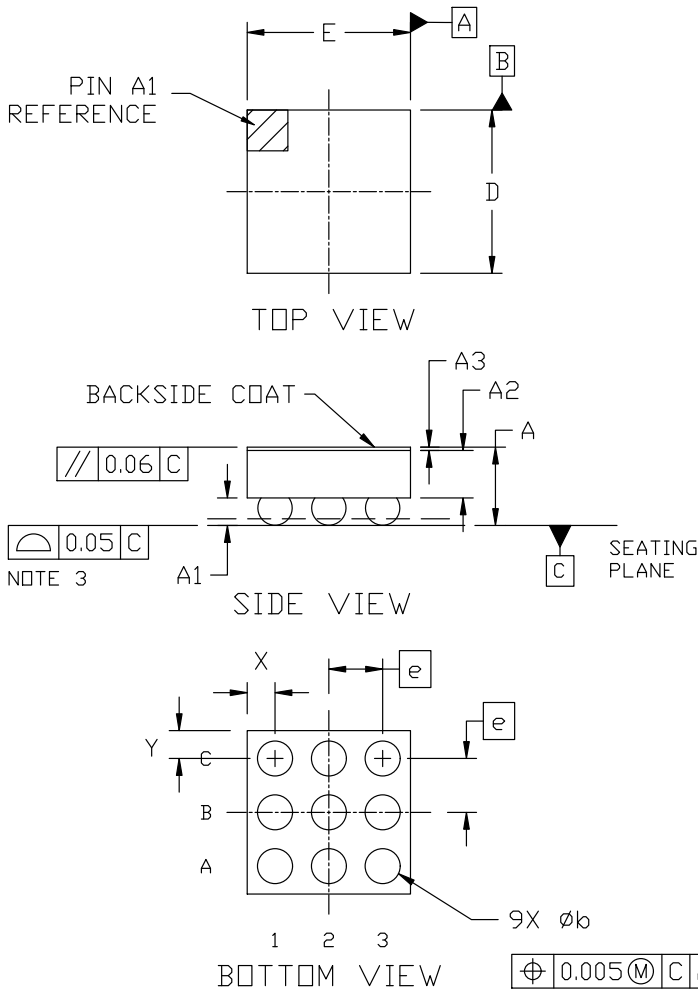

NOTES:

1. DIMENSIONING AND TOLERANCING PER ASME Y14.5M, 2009.
2. CONTROLLING DIMENSION: MILLIMETERS
3. COPLANARITY APPLIES TO THE SPHERICAL CROWNS OF THE SOLDER BALLS.
4. DATUM C, THE SEATING PLANE, IS DEFINED BY THE SPHERICAL CROWNS OF THE SOLDER BALLS.
5. DIMENSION b IS MEASURED AT THE MAXIMUM SOLDER BALL DIAMETER PARALLEL TO DATUM C.

| DIM | MILLIMETERS | | |
|-----|-------------|-------|-------|
| | MIN. | NOM. | MAX. |
| A | 0.542 | 0.581 | 0.620 |
| A1 | 0.183 | 0.203 | 0.223 |
| A2 | 0.335 | 0.353 | 0.371 |
| A3 | 0.022 | 0.025 | 0.027 |
| b | 0.24 | 0.26 | 0.28 |
| D | 1.185 | 1.215 | 1.245 |
| E | 1.185 | 1.215 | 1.245 |
| e | 0.400 BSC | | |
| X | 0.208 REF | | |
| Y | 0.208 REF | | |

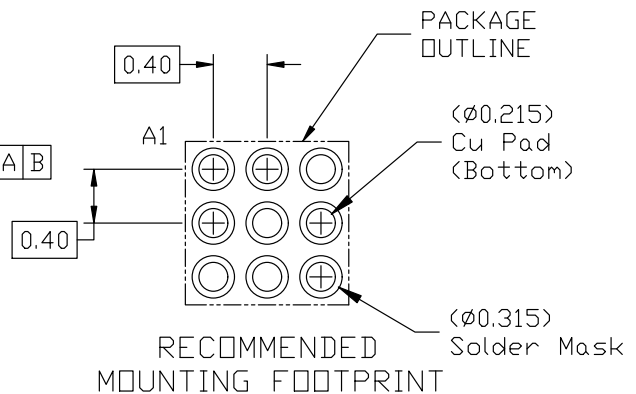

* For additional information on our Pb-Free strategy and soldering details, please download the onsemi Soldering and Mounting Techniques Reference Manual, SOLDERRM/D.

| | | |
|-------------------------|---------------------------------|--|
| DOCUMENT NUMBER: | 98AON13355G | Electronic versions are uncontrolled except when accessed directly from the Document Repository. Printed versions are uncontrolled except when stamped "CONTROLLED COPY" in red. |
| DESCRIPTION: | WLCSP9 1.215x1.215x0.581 | PAGE 1 OF 1 |

onsemi and ONSEMI are trademarks of Semiconductor Components Industries, LLC dba onsemi or its subsidiaries in the United States and/or other countries. onsemi reserves the right to make changes without further notice to any products herein. onsemi makes no warranty, representation or guarantee regarding the suitability of its products for any particular purpose, nor does onsemi assume any liability arising out of the application or use of any product or circuit, and specifically disclaims any and all liability, including without limitation special, consequential or incidental damages. onsemi does not convey any license under its patent rights nor the rights of others.

onsemi, **Onsemi**, and other names, marks, and brands are registered and/or common law trademarks of Semiconductor Components Industries, LLC dba "**onsemi**" or its affiliates and/or subsidiaries in the United States and/or other countries. **onsemi** owns the rights to a number of patents, trademarks, copyrights, trade secrets, and other intellectual property. A listing of **onsemi**'s product/patent coverage may be accessed at www.onsemi.com/site/pdf/Patent-Marking.pdf. **onsemi** reserves the right to make changes at any time to any products or information herein, without notice. The information herein is provided "as-is" and **onsemi** makes no warranty, representation or guarantee regarding the accuracy of the information, product features, availability, functionality, or suitability of its products for any particular purpose, nor does **onsemi** assume any liability arising out of the application or use of any product or circuit, and specifically disclaims any and all liability, including without limitation special, consequential or incidental damages. Buyer is responsible for its products and applications using **onsemi** products, including compliance with all laws, regulations and safety requirements or standards, regardless of any support or applications information provided by **onsemi**. "Typical" parameters which may be provided in **onsemi** data sheets and/or specifications can and do vary in different applications and actual performance may vary over time. All operating parameters, including "Typicals" must be validated for each customer application by customer's technical experts. **onsemi** does not convey any license under any of its intellectual property rights nor the rights of others. **onsemi** products are not designed, intended, or authorized for use as a critical component in life support systems or any FDA Class 3 medical devices or medical devices with a same or similar classification in a foreign jurisdiction or any devices intended for implantation in the human body. Should Buyer purchase or use **onsemi** products for any such unintended or unauthorized application, Buyer shall indemnify and hold **onsemi** and its officers, employees, subsidiaries, affiliates, and distributors harmless against all claims, costs, damages, and expenses, and reasonable attorney fees arising out of, directly or indirectly, any claim of personal injury or death associated with such unintended or unauthorized use, even if such claim alleges that **onsemi** was negligent regarding the design or manufacture of the part. **onsemi** is an Equal Opportunity/Affirmative Action Employer. This literature is subject to all applicable copyright laws and is not for resale in any manner.

ADDITIONAL INFORMATION

TECHNICAL PUBLICATIONS:

Technical Library: www.onsemi.com/design/resources/technical-documentation
onsemi Website: www.onsemi.com

ONLINE SUPPORT: www.onsemi.com/support

For additional information, please contact your local Sales Representative at www.onsemi.com/support/sales

OUR CERTIFICATE

DiGi provide top-quality products and perfect service for customer worldwide through standardization, technological innovation and continuous improvement. DiGi through third-party certification, we stricly control the quality of products and services. Welcome your RFQ to

Email: Info@DiGi-Electronics.com



Tel: +00 852-30501935

RFQ Email: Info@DiGi-Electronics.com

DiGi is a global authorized distributor of electronic components.