

# FDPC8012S Datasheet

[www.digi-electronics.com](http://www.digi-electronics.com)

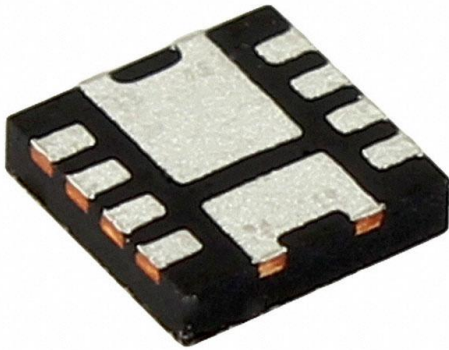

<https://www.DiGi-Electronics.com>

DiGi Electronics Part Number	FDPC8012S-DG
Manufacturer	<a href="#">onsemi</a>
Manufacturer Product Number	FDPC8012S
Description	MOSFET 2N-CH 25V 13A PWRCLIP-33
Detailed Description	Mosfet Array 25V 13A, 26A 800mW, 900mW Surface Mount Powerclip-33



Tel: +00 852-30501935

RFQ Email: [Info@DiGi-Electronics.com](mailto:Info@DiGi-Electronics.com)

DiGi is a global authorized distributor of electronic components.

## Purchase and inquiry

Manufacturer Product Number:

FDPC8012S

Series:

PowerTrench®

Technology:

MOSFET (Metal Oxide)

FET Feature:

Logic Level Gate

Current - Continuous Drain (Id) @ 25°C:

13A, 26A

Vgs(th) (Max) @ Id:

2.2V @ 250µA

Input Capacitance (Ciss) (Max) @ Vds:

1075pF @ 13V

Operating Temperature:

-55°C ~ 150°C (Tj)

Package / Case:

8-PowerWDFN

Base Product Number:

FDPC8012

Manufacturer:

onsemi

Product Status:

Active

Configuration:

2 N-Channel (Dual) Asymmetrical

Drain to Source Voltage (Vdss):

25V

Rds On (Max) @ Id, Vgs:

7mOhm @ 12A, 4.5V

Gate Charge (Qg) (Max) @ Vgs:

8nC @ 4.5V

Power - Max:

800mW, 900mW

Mounting Type:

Surface Mount

Supplier Device Package:

Powerclip-33

## Environmental & Export classification

RoHS Status:

ROHS3 Compliant

REACH Status:

REACH Unaffected

HTSUS:

8541.21.0095

Moisture Sensitivity Level (MSL):

1 (Unlimited)

ECCN:

EAR99

# MOSFET – Dual, N-Channel, Asymmetric, POWER TRENCH<sup>®</sup>, Power Clip, 25 V

## FDPC8012S

### General Description

This device includes two specialized N-Channel MOSFETs in a dual package. The switch node has been internally connected to enable easy placement and routing of synchronous buck converters. The control MOSFET (Q1) and synchronous SyncFET™ (Q2) have been designed to provide optimal power efficiency.

### Features

Q1: N-Channel

- Max  $R_{DS(on)}$  = 7.0 m $\Omega$  at  $V_{GS}$  = 4.5 V,  $I_D$  = 12 A

Q2: N-Channel

- Max  $R_{DS(on)}$  = 2.2 m $\Omega$  at  $V_{GS}$  = 4.5 V,  $I_D$  = 23 A
- Low Inductance Packaging Shortens Rise/Fall Times, Resulting in Lower Switching Losses
- MOSFET Integration Enables Optimum Layout for Lower Circuit Inductance and Reduced Switch Node Ringing
- RoHS Compliant

### Applications

- Computing
- Communications
- General Purpose Point of Load

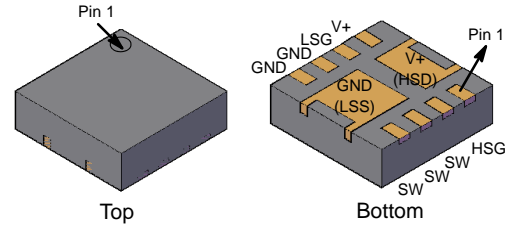

PQFN8 3.3X3.3, 0.65P  
CASE 483AZ

### MARKING DIAGRAM

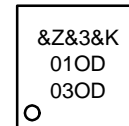

- &Z = Assembly Plant Code
- &3 = 3-Digit Date Code
- &K = 2-Digits Lot Run Traceability Code
- 01OD03OD = Device Code

### PIN ASSIGNMENT

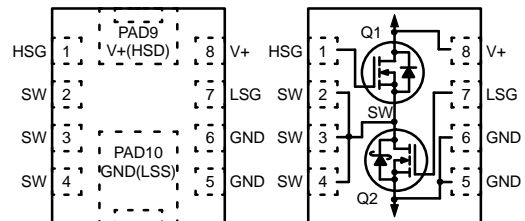

### ORDERING INFORMATION

See detailed ordering and shipping information on page 13 of this data sheet.

## FDPC8012S

MOSFET MAXIMUM RATINGS ( $T_A = 25^\circ\text{C}$  unless otherwise noted)

Symbol	Parameter	Q1	Q2	Unit	
$V_{DS}$	Drain to Source Voltage	25	25	V	
$V_{GS}$	Gate to Source Voltage	12	12	V	
$I_D$	Drain Current	– Continuous $T_C = 25^\circ\text{C}$	35	88	A
		– Continuous $T_A = 25^\circ\text{C}$	13 (Note 1a)	26 (Note 1b)	
		– Pulsed (Note 4)	40	120	
$E_{AS}$	Single Pulse Avalanche Energy (Note 3)	50	181	mJ	
$P_D$	Power Dissipation for Single Operation	$T_A = 25^\circ\text{C}$	1.6 (Note 1a)	2.0 (Note 1b)	W
		$T_A = 25^\circ\text{C}$	0.8 (Note 1c)	0.9 (Note 1d)	
$T_J, T_{STG}$	Operating and Storage Junction Temperature Range	–55 to +150		$^\circ\text{C}$	

Stresses exceeding those listed in the Maximum Ratings table may damage the device. If any of these limits are exceeded, device functionality should not be assumed, damage may occur and reliability may be affected.

## THERMAL CHARACTERISTICS

Symbol	Characteristic	Value	Value	Unit
$R_{\theta JA}$	Thermal Resistance, Junction to Ambient	77 (Note 1a)	63 (Note 1b)	$^\circ\text{C}/\text{W}$
$R_{\theta JA}$	Thermal Resistance, Junction to Ambient	151 (Note 1c)	135 (Note 1d)	
$R_{\theta JC}$	Thermal Resistance, Junction to Case	5.0	3.5	

ELECTRICAL CHARACTERISTICS ( $T_J = 25^\circ\text{C}$  unless otherwise noted)

Symbol	Parameter	Test Condition	Type	Min	Typ	Max	Unit
<b>OFF CHARACTERISTICS</b>							
$BV_{DSS}$	Drain to Source Breakdown Voltage	$I_D = 250 \mu\text{A}, V_{GS} = 0 \text{ V}$ $I_D = 1 \text{ mA}, V_{GS} = 0 \text{ V}$	Q1 Q2	25 25	– –	– –	V
$\frac{\Delta BV_{DSS}}{\Delta T_J}$	Breakdown Voltage Temperature Coefficient	$I_D = 250 \mu\text{A}$ , referenced to $25^\circ\text{C}$ $I_D = 10 \text{ mA}$ , referenced to $25^\circ\text{C}$	Q1 Q2	– –	18 22	– –	$\text{mV}/^\circ\text{C}$
$I_{DSS}$	Zero Gate Voltage Drain Current	$V_{DS} = 20 \text{ V}, V_{GS} = 0 \text{ V}$ $V_{DS} = 20 \text{ V}, V_{GS} = 0 \text{ V}$	Q1 Q2	– –	– –	1 500	$\mu\text{A}$
$I_{GSS}$	Gate to Source Leakage Current, Forward	$V_{GS} = 12 \text{ V}/-8 \text{ V}, V_{DS} = 0 \text{ V}$ $V_{GS} = 12 \text{ V}/-8 \text{ V}, V_{DS} = 0 \text{ V}$	Q1 Q2	– –	– –	$\pm 100$ $\pm 100$	nA

## ON CHARACTERISTICS

$V_{GS(th)}$	Gate to Source Threshold Voltage	$V_{GS} = V_{DS}, I_D = 250 \mu\text{A}$ $V_{GS} = V_{DS}, I_D = 1 \text{ mA}$	Q1 Q2	0.8 1.1	1.3 1.6	2.2 2.2	V
$\frac{\Delta V_{GS(th)}}{\Delta T_J}$	Gate to Source Threshold Voltage Temperature Coefficient	$I_D = 250 \mu\text{A}$ , referenced to $25^\circ\text{C}$ $I_D = 10 \text{ mA}$ , referenced to $25^\circ\text{C}$	Q1 Q2	– –	–4 –4	– –	$\text{mV}/^\circ\text{C}$
$R_{DS(on)}$	Drain to Source On Resistance	$V_{GS} = 4.5 \text{ V}, I_D = 12 \text{ A}$ $V_{GS} = 4.5 \text{ V}, I_D = 12 \text{ A}, T_J = 125^\circ\text{C}$	Q1	– –	5.2 7.5	7.0 10.5	m $\Omega$
		$V_{GS} = 4.5 \text{ V}, I_D = 23 \text{ A}$ $V_{GS} = 4.5 \text{ V}, I_D = 23 \text{ A}, T_J = 125^\circ\text{C}$	Q2	– –	1.6 2.3	2.2 3.2	
$g_{FS}$	Forward Transconductance	$V_{DS} = 5 \text{ V}, I_D = 13 \text{ A}$	Q1	–	79	–	S
		$V_{DS} = 5 \text{ V}, I_D = 26 \text{ A}$	Q2	–	200	–	

## DYNAMIC CHARACTERISTICS

$C_{iss}$	Input Capacitance	Q1: $V_{DS} = 13 \text{ V}, V_{GS} = 0 \text{ V}, f = 1 \text{ MHz}$ Q2: $V_{DS} = 13 \text{ V}, V_{GS} = 0 \text{ V}, f = 1 \text{ MHz}$	Q1	–	1075	–	$\text{pF}$
			Q2	–	3456	–	
$C_{oss}$	Output Capacitance	Q1: $V_{DS} = 13 \text{ V}, V_{GS} = 0 \text{ V}, f = 1 \text{ MHz}$ Q2: $V_{DS} = 13 \text{ V}, V_{GS} = 0 \text{ V}, f = 1 \text{ MHz}$	Q1	–	250	–	$\text{pF}$
			Q2	–	885	–	
$C_{rss}$	Reverse Transfer Capacitance	Q1: $V_{DS} = 13 \text{ V}, V_{GS} = 0 \text{ V}, f = 1 \text{ MHz}$ Q2: $V_{DS} = 13 \text{ V}, V_{GS} = 0 \text{ V}, f = 1 \text{ MHz}$	Q1	–	50	–	$\text{pF}$
			Q2	–	130	–	
$R_g$	Gate Resistance	Q1: $V_{DS} = 13 \text{ V}, V_{GS} = 0 \text{ V}, f = 1 \text{ MHz}$ Q2: $V_{DS} = 13 \text{ V}, V_{GS} = 0 \text{ V}, f = 1 \text{ MHz}$	Q1	0.1	0.4	2.0	$\Omega$
			Q2	0.1	0.5	2.0	

## FDPC8012S

ELECTRICAL CHARACTERISTICS ( $T_J = 25^\circ\text{C}$  unless otherwise noted) (continued)

Symbol	Parameter	Test Condition	Type	Min	Typ	Max	Unit
<b>SWITCHING CHARACTERISTICS</b>							
$t_{d(on)}$	Turn-On Delay Time	Q1: $V_{DD} = 13\text{ V}, I_D = 13\text{ A}, R_{GEN} = 6\ \Omega$ Q2: $V_{DD} = 13\text{ V}, I_D = 26\text{ A}, R_{GEN} = 6\ \Omega$	Q1	–	6	–	ns
$t_r$	Rise Time		Q2	–	12	–	ns
$t_{d(off)}$	Turn-Off Delay Time		Q1	–	2	–	ns
$t_f$	Fall Time		Q2	–	3	–	ns
$Q_g$	Total Gate Charge	$V_{GS} = 0\text{ V to } 4.5\text{ V}$ Q1: $V_{DD} = 13\text{ V}, I_D = 13\text{ A}$ Q2: $V_{DD} = 13\text{ V}, I_D = 26\text{ A}$	Q1	–	8	–	nC
$Q_{gs}$	Gate to Source Gate Charge		Q2	–	25	–	nC
$Q_{gd}$	Gate to Drain "Miller" Charge		Q1	–	2.3	–	nC
			Q2	–	7.8	–	nC
			Q1	–	2.0	–	nC
			Q2	–	6.4	–	nC

## DRAIN-SOURCE CHARACTERISTICS

$V_{SD}$	Source to Drain Diode Forward Voltage	$V_{GS} = 0\text{ V}, I_S = 13\text{ A}$ (Note 2) $V_{GS} = 0\text{ V}, I_S = 26\text{ A}$ (Note 2)	Q1	–	0.8	1.2	V
$t_{rr}$	Reverse Recovery Time	Q1: $I_F = 13\text{ A}, di/dt = 100\text{ A}/\mu\text{s}$ Q2: $I_F = 26\text{ A}, di/dt = 300\text{ A}/\mu\text{s}$	Q1	–	20	35	ns
$Q_{rr}$	Reverse Recovery Charge		Q2	–	27	43	ns
			Q1	–	6	12	nC
			Q2	–	27	43	nC

Product parametric performance is indicated in the Electrical Characteristics for the listed test conditions, unless otherwise noted. Product performance may not be indicated by the Electrical Characteristics if operated under different conditions.

## NOTES:

- $R_{\theta JA}$  is determined with the device mounted on a 1 in<sup>2</sup> pad 2 oz copper pad on a 1.5 x 1.5 in. board of FR-4 material.  $R_{\theta JC}$  is guaranteed by design while  $R_{\theta CA}$  is determined by the user's board design.

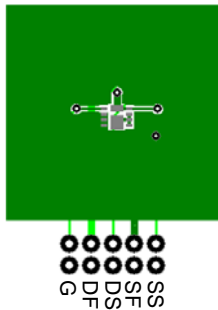

a.  $77^\circ\text{C}/\text{W}$  when mounted on a 1 in<sup>2</sup> pad of 2 oz copper

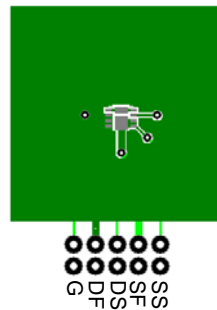

b.  $63^\circ\text{C}/\text{W}$  when mounted on a 1 in<sup>2</sup> pad of 2 oz copper



c.  $151^\circ\text{C}/\text{W}$  when mounted on a minimum pad of 2 oz copper



d.  $135^\circ\text{C}/\text{W}$  when mounted on a minimum pad of 2 oz copper

- Pulse Test: Pulse Width < 300  $\mu\text{s}$ , Duty cycle < 2.0%.
- Q1:  $E_{AS}$  of 50 mJ is based on starting  $T_J = 25^\circ\text{C}$ ; N-ch:  $L = 3\text{ mH}, I_{AS} = 5.8\text{ A}, V_{DD} = 25\text{ V}, V_{GS} = 10\text{ V}$ . 100% test at  $L = 0.1\text{ mH}, I_{AS} = 14.5\text{ A}$ . Q2:  $E_{AS}$  of 181 mJ is based on starting  $T_J = 25^\circ\text{C}$ ; N-ch:  $L = 3\text{ mH}, I_{AS} = 11\text{ A}, V_{DD} = 25\text{ V}, V_{GS} = 10\text{ V}$ . 100% test at  $L = 0.1\text{ mH}, I_{AS} = 32.9\text{ A}$ .
- Pulsed  $I_d$  limited by junction temperature,  $t_d \leq 10\ \mu\text{s}$ . Please refer to SOA curve for more details.

# FDPC8012S

## TYPICAL CHARACTERISTICS (Q1 N-CHANNEL) ( $T_J = 25^\circ\text{C}$ unless otherwise noted)

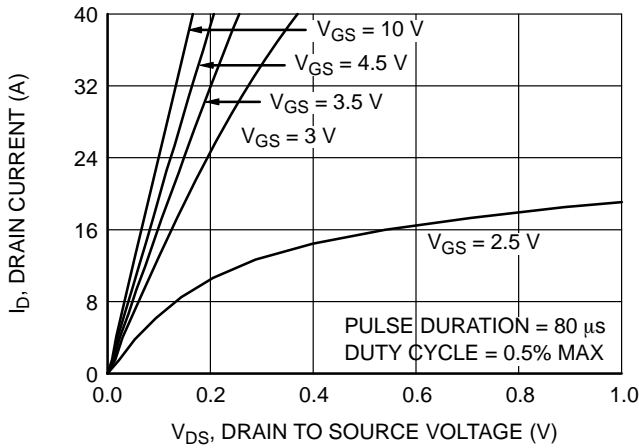

Figure 1. On-Region Characteristics

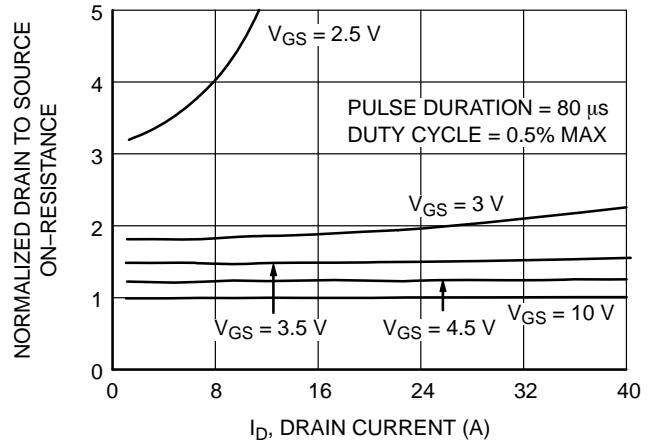

Figure 2. Normalized On-Resistance vs. Drain Current and Gate Voltage

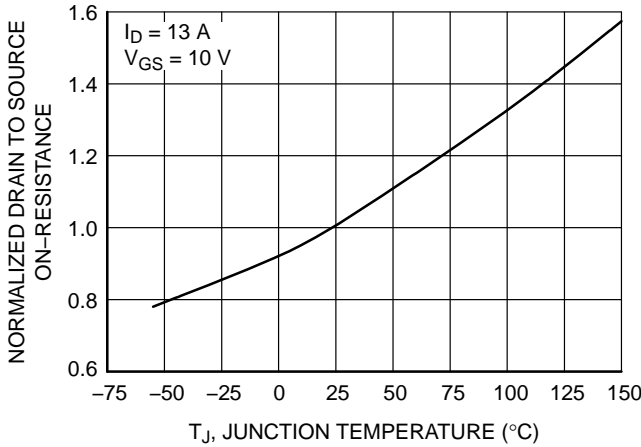

Figure 3. Normalized On-Resistance vs. Junction Temperature

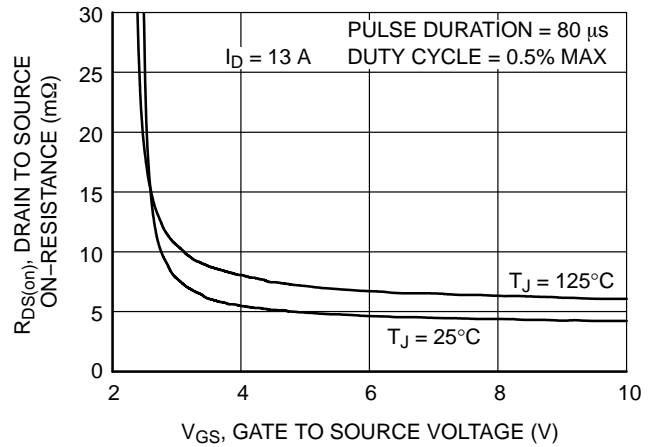

Figure 4. On-Resistance vs. Gate to Source Voltage

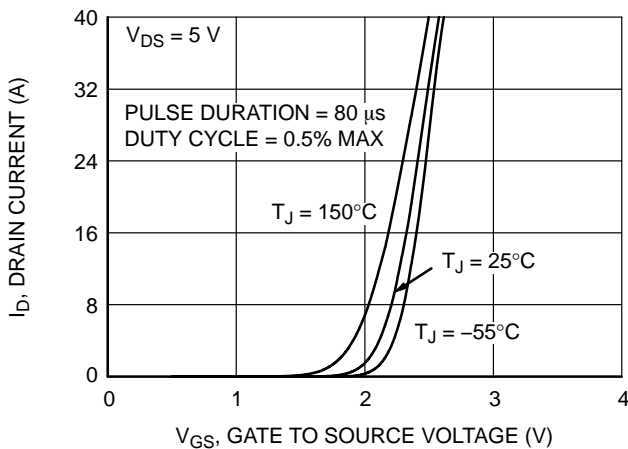

Figure 5. Transfer Characteristics

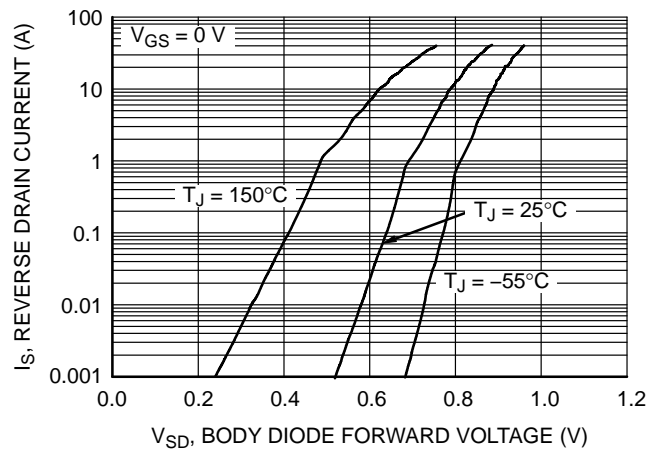

Figure 6. Source to Drain Diode Forward Voltage vs. Source Current

# FDPC8012S

## TYPICAL CHARACTERISTICS (Q1 N-CHANNEL) ( $T_J = 25^\circ\text{C}$ unless otherwise noted) (continued)

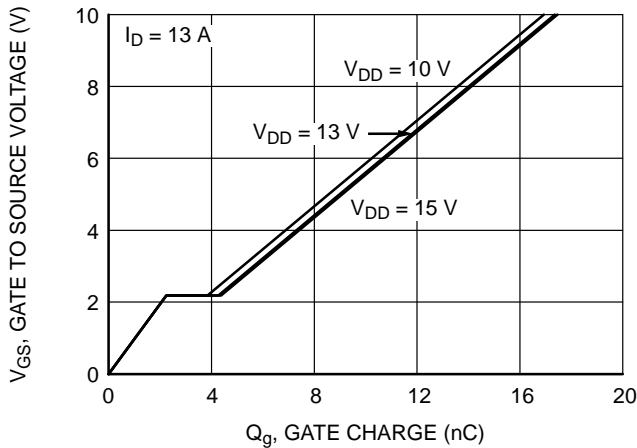

Figure 7. Gate Charge Characteristics

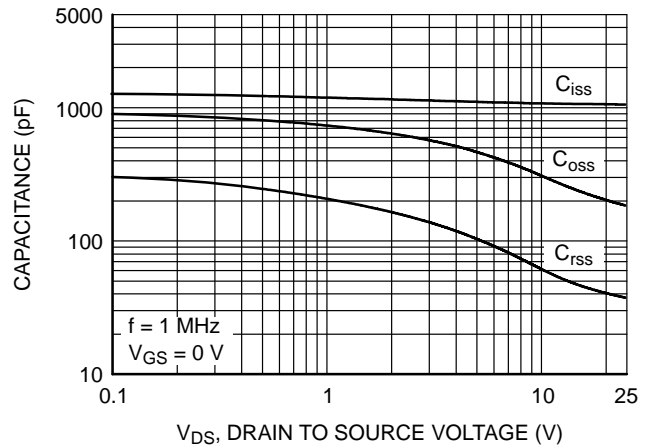

Figure 8. Capacitance vs. Drain to Source Voltage

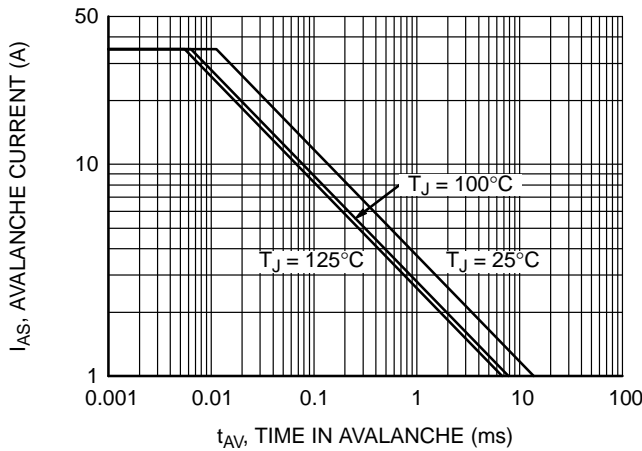

Figure 9. Unclamped Inductive Switching Capability

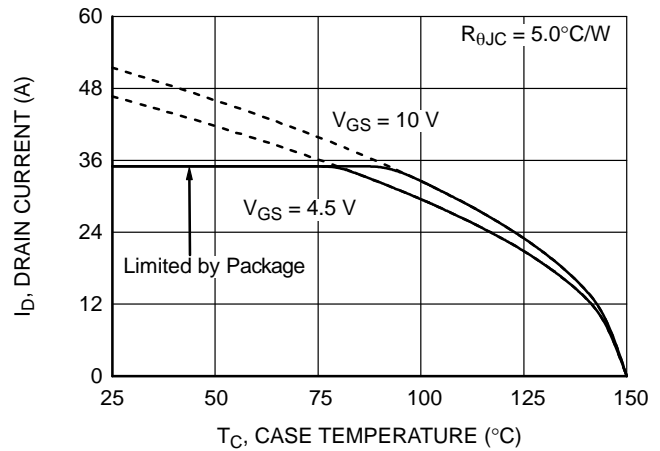

Figure 10. Maximum Continuous Drain Current vs. Case Temperature

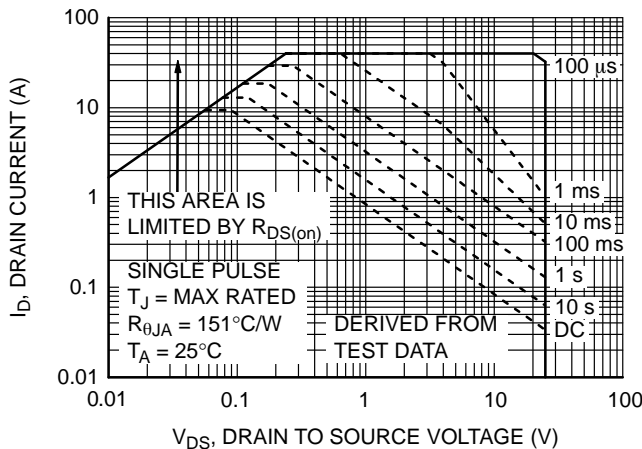

Figure 11. Forward Bias Safe Operating Area

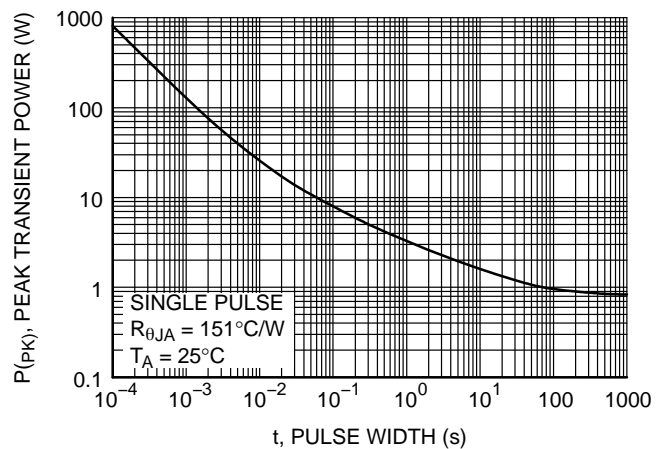

Figure 12. Single Pulse Maximum Power Dissipation

### FDPC8012S

TYPICAL CHARACTERISTICS (Q1 N-CHANNEL) ( $T_J = 25^\circ\text{C}$  unless otherwise noted) (continued)

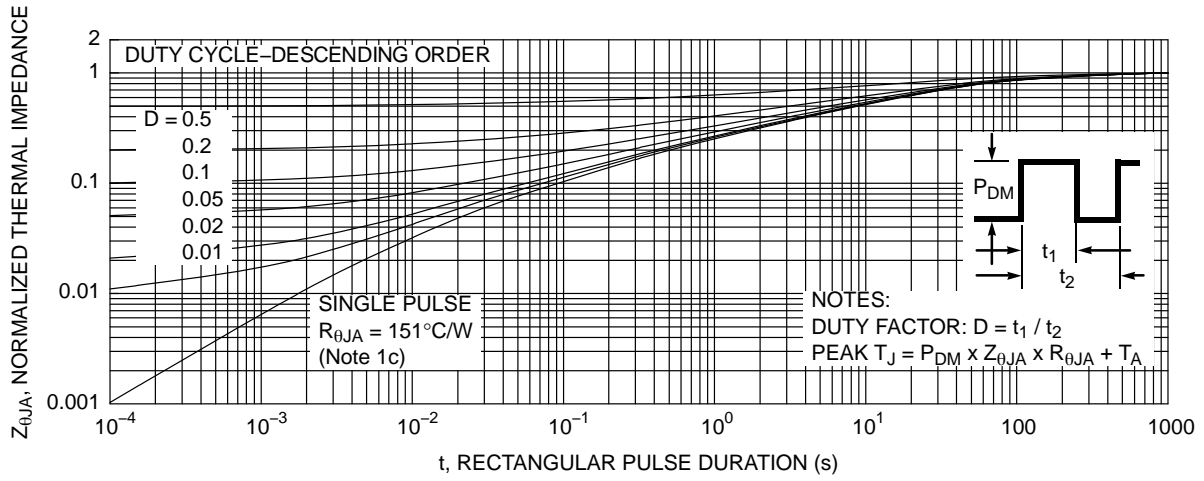

Figure 13. Junction-to-Ambient Transient Thermal Response Curve



# FDPC8012S

## TYPICAL CHARACTERISTICS (Q2 N-CHANNEL) ( $T_J = 25^\circ\text{C}$ unless otherwise noted)

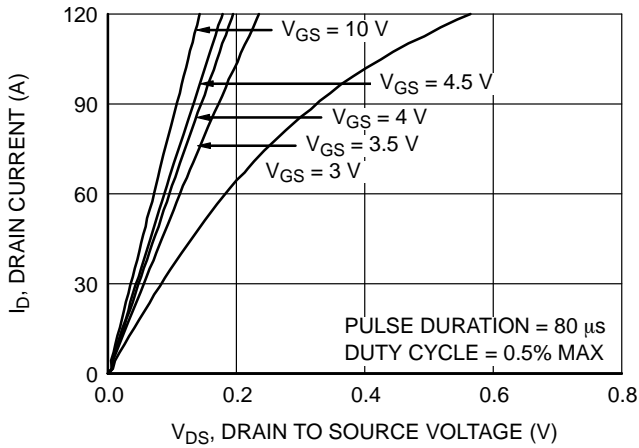

Figure 14. On-Region Characteristics

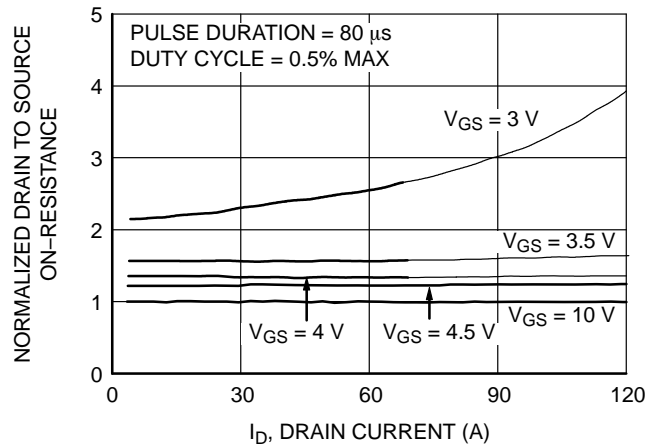

Figure 15. Normalized On-Resistance vs. Drain Current and Gate Voltage

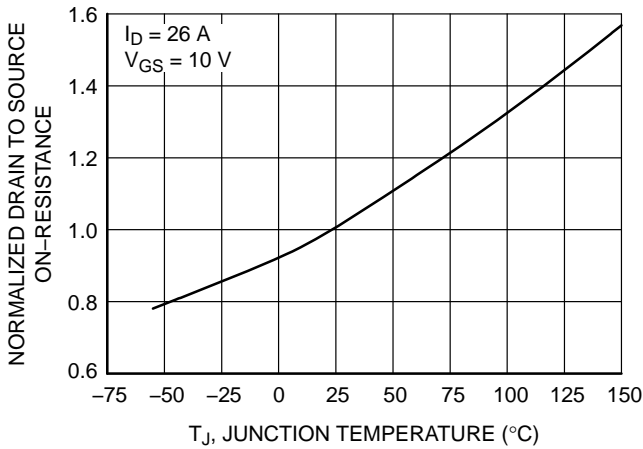

Figure 16. Normalized On-Resistance vs. Junction Temperature

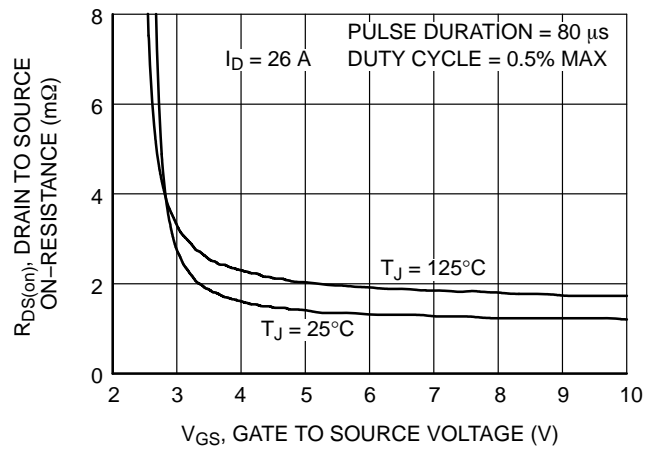

Figure 17. On-Resistance vs. Gate to Source Voltage

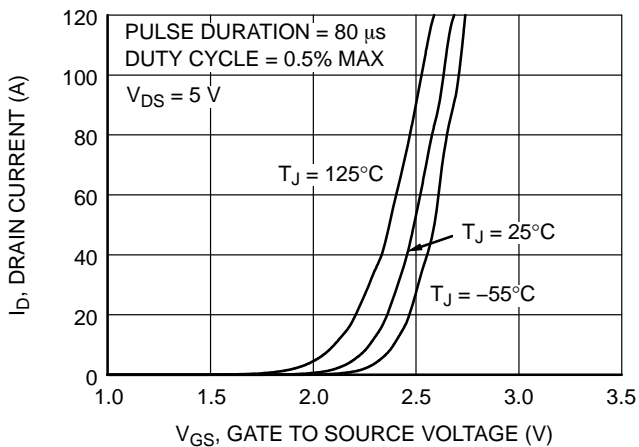

Figure 18. Transfer Characteristics

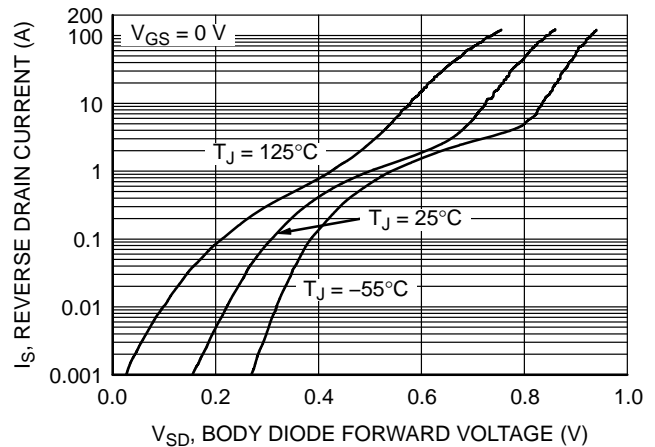

Figure 19. Source to Drain Diode Forward Voltage vs. Source Current

# FDPC8012S

## TYPICAL CHARACTERISTICS (Q2 N-CHANNEL) ( $T_J = 25^\circ\text{C}$ unless otherwise noted) (continued)

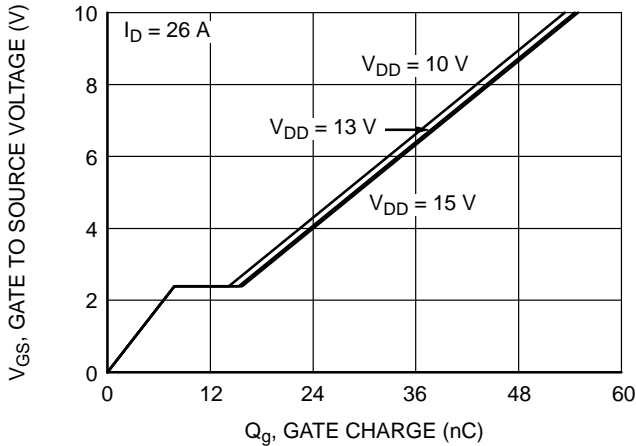

Figure 20. Gate Charge Characteristics

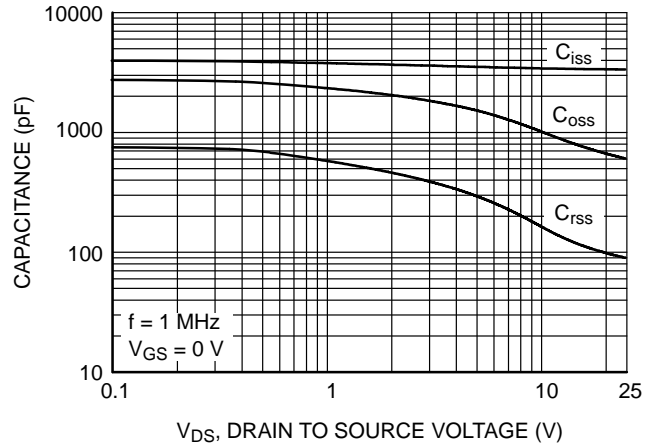

Figure 21. Capacitance vs. Drain to Source Voltage

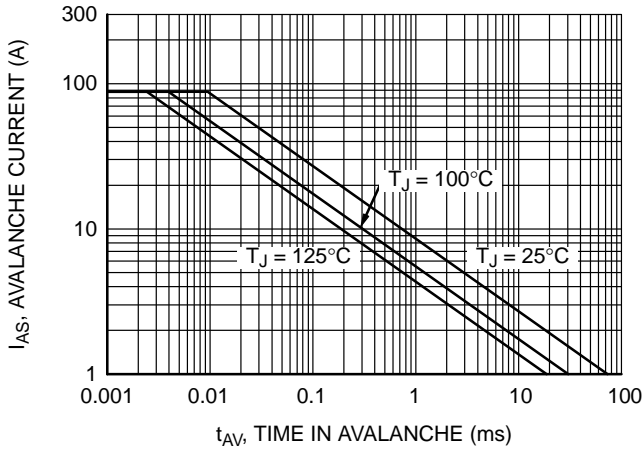

Figure 22. Unclamped Inductive Switching Capability

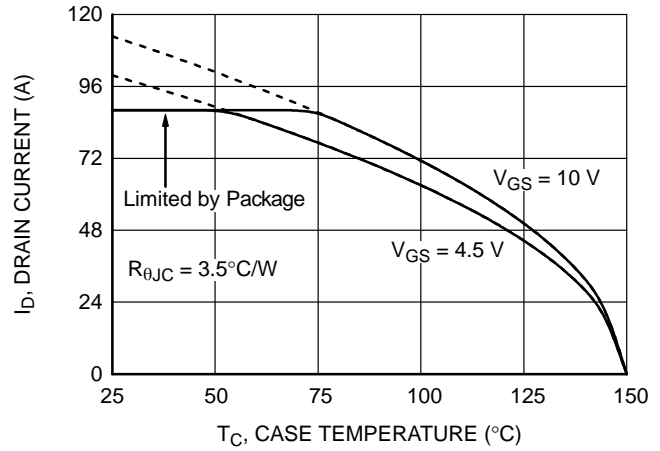

Figure 23. Maximum Continuous Drain Current vs. Case Temperature

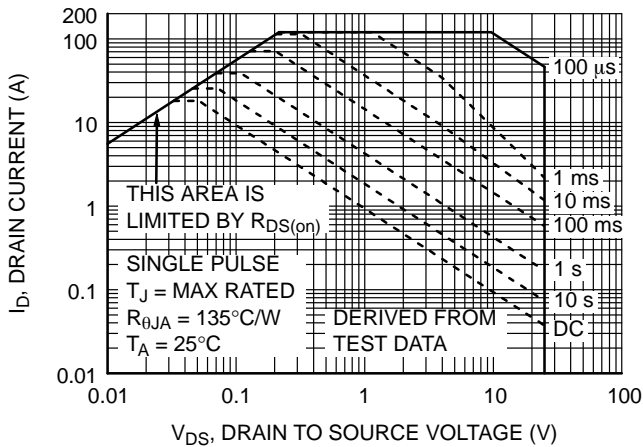

Figure 24. Forward Bias Safe Operating Area

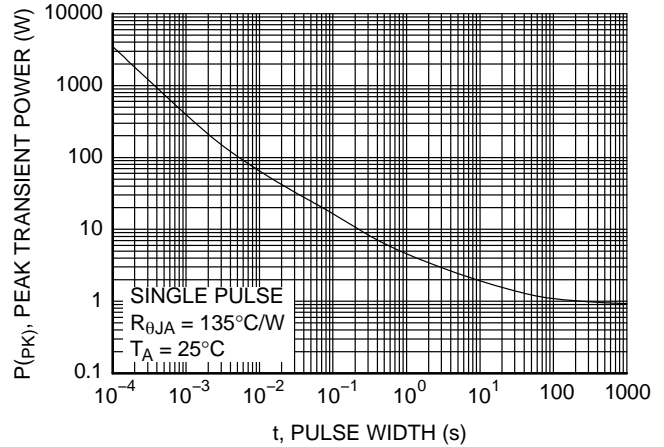

Figure 25. Single Pulse Maximum Power Dissipation

### FDPC8012S

TYPICAL CHARACTERISTICS (Q2 N-CHANNEL) ( $T_J = 25^\circ\text{C}$  unless otherwise noted) (continued)

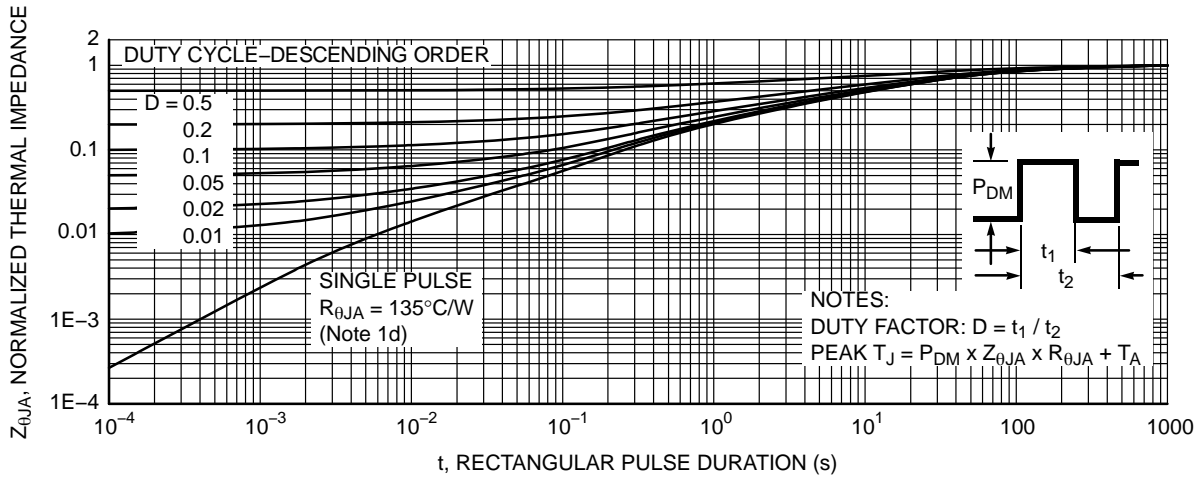
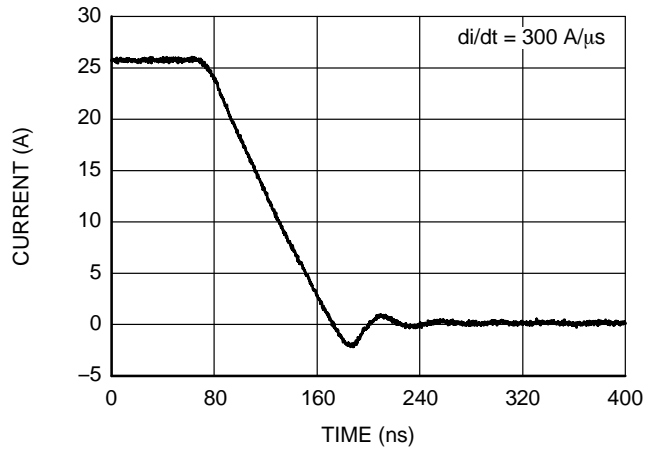

Figure 26. Junction-to-Ambient Transient Thermal Response Curve

**FDPC8012S****TYPICAL CHARACTERISTICS** (continued)**SyncFET Schottky Body Diode Characteristics**

onsemi's SyncFET process embeds a Schottky diode in parallel with POWERTRENCH MOSFET. This diode exhibits similar characteristics to a discrete external Schottky diode in parallel with a MOSFET. Figure 27 shows the reverse recovery characteristic of the FDPC8012S.



**Figure 27. FDPC8012S SyncFET Body Diode Reverse Recovery Characteristic**

Schottky barrier diodes exhibit significant leakage at high temperature and high reverse voltage. This will increase the power in the device.

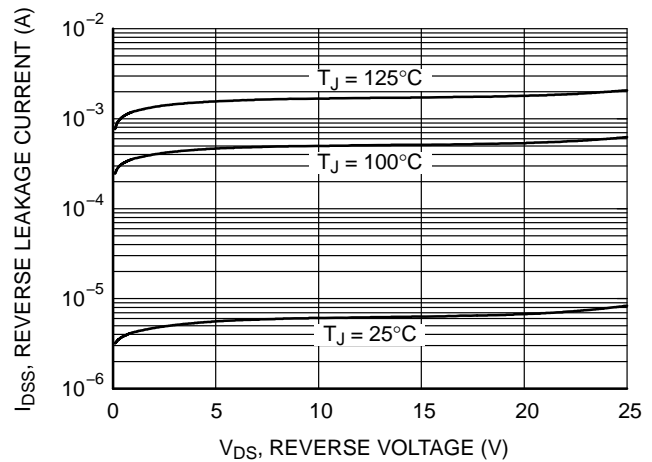
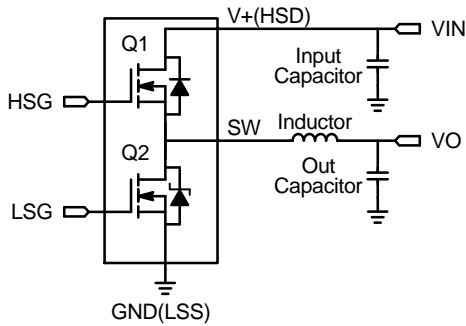

**Figure 28. SyncFET Body Diode Reverse Leakage versus Drain-Source Voltage**

# FDPC8012S

## APPLICATION INFORMATION

### Typical Application Diagram (Synchronous Rectifier Buck Converter)



**Figure 29. Power Clip in Buck Converter Topology**

As shown in Figure 29 in the Power Clip package Q1 is the High Side MOSFET (Control MOSFET) and Q2 is the Low Side MOSFET (Synchronous MOSFET). Figure 30 below shows the package pin out. The blue overlay on the drawing indicates a typical PCB land pattern for the part.

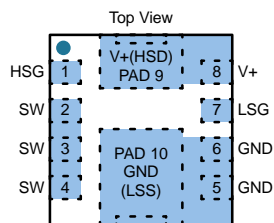

**Figure 30. Top View of Power Clip**

Table 1 Pin Information shows the name and description of each pin.

**Table 1. PIN INFORMATION**

PIN		Description
Number	Name	
1	HSG	Gate signal input of Q1 Gate
2, 3, 4	SW	Switch or Phase node, Source of Q1 and Drain of Q2
5, 6, PAD 10	GND, GND(LSS) PAD	Ground, Source of Q2
7	LSG	Gate signal input of Q2 Gate
8, PAD 9	V+, V+(HSD) PAD	Input voltage of SR Buck converter, Drain of Q1

## FDPC8012S

### RECOMMENDED PCB LAYOUT GUIDELINES

As a PCB designer, it is necessary to address critical issues in layout to minimize losses and optimize the performance of the power train. Power Clip is a high power density solution and all high current flow paths, such as V+(HSD), SW and GND(LSS) should be short and wide for minimal

resistance and inductance. V+(HSD) and GND(LSS) are the primary heat flow paths for the Power Clip. A recommended layout procedure is discussed below to maximize the electrical and thermal performance of the part.

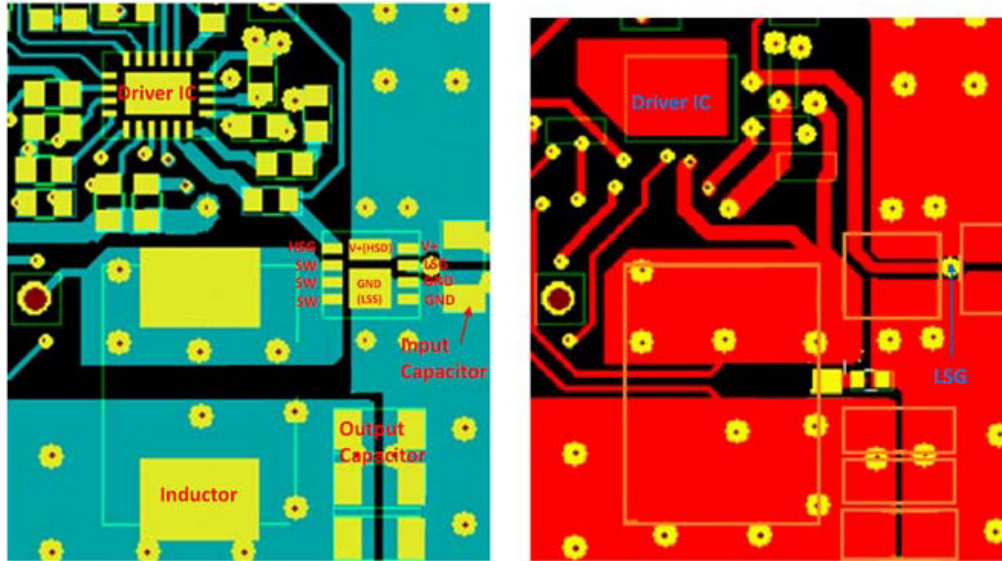

Figure 31. Top/Component (Green) View and Bottom (Red) PCB View

Following is a guideline, not a requirement which the PCB designer should consider.

Figure 31 shows an example of a well designed layout. The discussion that follows summarizes the key features of this layout.

- "The input ceramic bypass capacitor between VIN and GND should be placed as close as possible to the pins V+ / V+(HSD) PAD and GND / GND(LSS) PAD to help reduce parasitic inductance and high frequency ringing. Several capacitors may be placed in parallel, and capacitors may be placed on both the top and bottom side of the board. The capacitor located immediately adjacent to the Power Clip will be the most effective at reducing HF parasitic. Caps located farther away, or on the opposite side of the board will also assist, but will be less effective due to increased trace inductance.
- "The Power Clip package design, with very short distance between pins V+ and GND, allows for a short connect distance to the input cap. This is a factor that enables the Power Clip switch loop to have very low parasitic inductance.
- "Use large copper areas on the component side to connect the V+ pin and V+ (HSD) pad, and the GND and GND(LSS) PAD.
- "The SW to inductor copper trace is a high current path. It will also be a high noise region due to switching voltage

transients. The trace should be short and wide to enable a low resistance path and to minimize the size of the noise region. Care should be taken to minimize coupling of this trace to adjacent traces. The layout in Figure 31 shows a good example of this short, wide path.

- "The POWER TRENCH Technology MOSFETs used in the Power Clip are effective at minimizing SW node ringing. They incorporate a proprietary design that minimizes the peak overshoot ring voltage on the switch node (SW). They allow the part to operate well within the breakdown voltage limits. For most layouts, this eliminates the need to add an external snubber circuit. If the designer chooses to use an RC snubber, it should be placed close to the part between the SW pins and GND / GND(LSS) PAD to dampen the high frequency ringing.
- "The Driver IC should be placed relatively close to HSG pin and LSG pin to minimize G drive trace inductance. Excessive G trace length may slow the switching speed of the HS drive. And it may lead to excessive ringing on the LS G. If the designer must place the driver a significant distance away from the Power Clip, it would be a good practice to include a 0 Ohm resistor in the LS G path as a place holder. In the final design, if the LS G exhibits excessive LF ringing, efficiency can often be improved by changing this resistor to a few Ohms to dampen the LS G LF ringing.

## FDPC8012S

- The Power Clip has very good Junction–PCB heat transfer from all power pins. It has much better heat transfer Junction–GND (LSS) than traditional dual FET packages. In most cases, board ground will be the most effective heat transfer path on the PCB. Use a large copper area between GND / GND(LSS) PAD pins and board ground. To ensure the best thermal and electrical connection to ground, we recommend using multiple vias to interconnect ground plane layers as shown in Figure 31.
- Use multiple vias in parallel on each copper region to interconnect top, inner and bottom layers. This will reduce resistance and inductance of the vias and will improve thermal conductivity. Vias should be relatively large, around 8 mils to 10 mils.
- Avoid using narrow thermal relief traces on the V+ / V+(HSD) PAD and GND / GND(LSS) PAD pins. These will increase HF switch loop inductance. And these will increase ringing of the HF power loop and the SW node.

### PACKAGE MARKING AND ORDERING INFORMATION

Device	Device Marking	Package	Reel Size	Tape Width	Shipping <sup>†</sup>
FDPC8012S	01OD/03OD	PQFN8 3.3X3.3, 0.65P Power Clip 33	13"	10 mm	3000 / Tape & Reel

<sup>†</sup>For information on tape and reel specifications, including part orientation and tape sizes, please refer to our Tape and Reel Packaging Specifications Brochure, BRD8011/D.

POWERTRENCH is registered trademark of Semiconductor Components Industries, LLC dba "onsemi" or its affiliates and/or subsidiaries in the United States and/or other countries.

SyncFET is trademark of Semiconductor Components Industries, LLC dba "onsemi" or its affiliates and/or subsidiaries in the United States and/or other countries.



**MECHANICAL CASE OUTLINE  
PACKAGE DIMENSIONS**

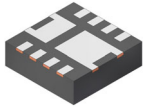

**PQFN8 3.3X3.3, 0.65P**  
CASE 483AZ  
ISSUE B

DATE 14 FEB 2022

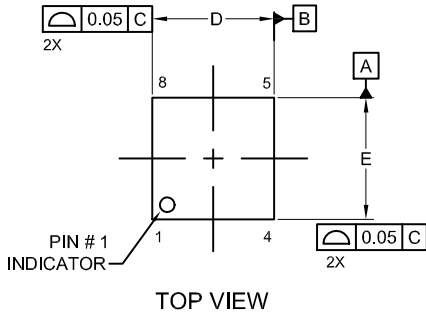

TOP VIEW

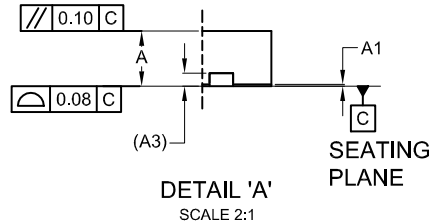

DETAIL 'A'  
SCALE 2:1

NOTES:

1. DIMENSIONING AND TOLERANCING PER ASME Y14.5M, 2009.
2. CONTROLLING DIMENSION: MILLIMETERS
3. COPLANARITY APPLIES TO THE EXPOSED PADS AS WELL AS THE TERMINALS.
4. DIMENSIONS DO NOT INCLUDE BURRS OR MOLD FLASH. MOLD FLASH OR BURRS DOES NOT EXCEED 0.10MM.
5. SEATING PLANE IS DEFINED BY THE TERMINALS. "A1" IS DEFINED AS THE DISTANCE FROM THE SEATING PLANE TO THE LOWEST POINT ON THE PACKAGE BODY.
6. IT IS RECOMMENDED TO HAVE NO TRACES OR VIAS WITHIN THE KEEP OUT AREA.

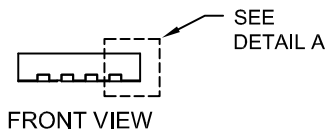

FRONT VIEW

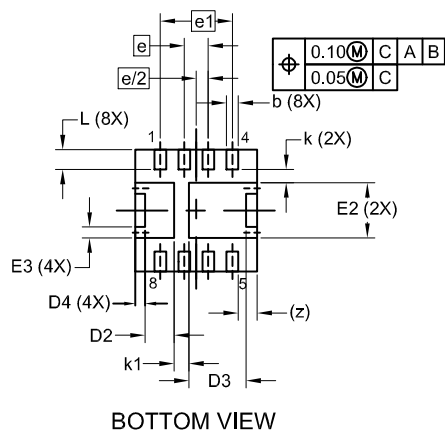

BOTTOM VIEW

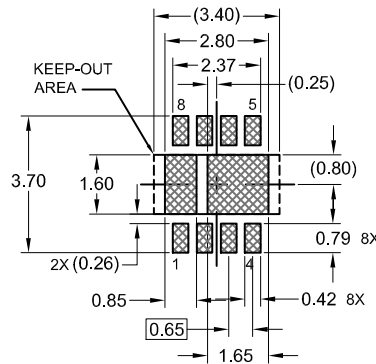

LAND PATTERN RECOMMENDATION  
\*FOR ADDITIONAL INFORMATION ON OUR PB-FREE STRATEGY AND SOLDERING DETAILS, PLEASE DOWNLOAD THE ON SEMICONDUCTOR SOLDERING AND MOUNTING TECHNIQUES REFERENCE MANUAL, SOLDERM/D.

DIM	MILLIMETERS		
	MIN	NOM	MAX
A	0.70	0.75	0.80
A1	0.00	--	0.05
A3	0.20 REF		
b	0.27	0.32	0.37
D	3.20	3.30	3.40
D2	0.69	0.79	0.89
D3	1.45	1.55	1.65
D4	0.16	0.26	0.36
E	3.20	3.30	3.40
E2	1.40	1.50	1.60
E3	0.30 REF		
e	0.65 BSC		
e1	1.95 BSC		
e/2	0.325 BSC		
k	0.36 REF		
k1	0.40 REF		
L	0.44	0.54	0.64
z	0.52 REF		

<b>DOCUMENT NUMBER:</b>	<b>98AON13675G</b>	Electronic versions are uncontrolled except when accessed directly from the Document Repository. Printed versions are uncontrolled except when stamped "CONTROLLED COPY" in red.
<b>DESCRIPTION:</b>	<b>PQFN8 3.3X3.3, 0.65P</b>	<b>PAGE 1 OF 1</b>

onsemi and Onsemi are trademarks of Semiconductor Components Industries, LLC dba onsemi or its subsidiaries in the United States and/or other countries. onsemi reserves the right to make changes without further notice to any products herein. onsemi makes no warranty, representation or guarantee regarding the suitability of its products for any particular purpose, nor does onsemi assume any liability arising out of the application or use of any product or circuit, and specifically disclaims any and all liability, including without limitation special, consequential or incidental damages. onsemi does not convey any license under its patent rights nor the rights of others.



**onsemi**, **Onsemi**, and other names, marks, and brands are registered and/or common law trademarks of Semiconductor Components Industries, LLC dba "**onsemi**" or its affiliates and/or subsidiaries in the United States and/or other countries. **onsemi** owns the rights to a number of patents, trademarks, copyrights, trade secrets, and other intellectual property. A listing of **onsemi**'s product/patent coverage may be accessed at [www.onsemi.com/site/pdf/Patent-Marking.pdf](http://www.onsemi.com/site/pdf/Patent-Marking.pdf). **onsemi** reserves the right to make changes at any time to any products or information herein, without notice. The information herein is provided "as-is" and **onsemi** makes no warranty, representation or guarantee regarding the accuracy of the information, product features, availability, functionality, or suitability of its products for any particular purpose, nor does **onsemi** assume any liability arising out of the application or use of any product or circuit, and specifically disclaims any and all liability, including without limitation special, consequential or incidental damages. Buyer is responsible for its products and applications using **onsemi** products, including compliance with all laws, regulations and safety requirements or standards, regardless of any support or applications information provided by **onsemi**. "Typical" parameters which may be provided in **onsemi** data sheets and/or specifications can and do vary in different applications and actual performance may vary over time. All operating parameters, including "Typicals" must be validated for each customer application by customer's technical experts. **onsemi** does not convey any license under any of its intellectual property rights nor the rights of others. **onsemi** products are not designed, intended, or authorized for use as a critical component in life support systems or any FDA Class 3 medical devices or medical devices with a same or similar classification in a foreign jurisdiction or any devices intended for implantation in the human body. Should Buyer purchase or use **onsemi** products for any such unintended or unauthorized application, Buyer shall indemnify and hold **onsemi** and its officers, employees, subsidiaries, affiliates, and distributors harmless against all claims, costs, damages, and expenses, and reasonable attorney fees arising out of, directly or indirectly, any claim of personal injury or death associated with such unintended or unauthorized use, even if such claim alleges that **onsemi** was negligent regarding the design or manufacture of the part. **onsemi** is an Equal Opportunity/Affirmative Action Employer. This literature is subject to all applicable copyright laws and is not for resale in any manner.

#### ADDITIONAL INFORMATION

**TECHNICAL PUBLICATIONS:**

Technical Library: [www.onsemi.com/design/resources/technical-documentation](http://www.onsemi.com/design/resources/technical-documentation)  
onsemi Website: [www.onsemi.com](http://www.onsemi.com)

**ONLINE SUPPORT:** [www.onsemi.com/support](http://www.onsemi.com/support)

For additional information, please contact your local Sales Representative at [www.onsemi.com/support/sales](http://www.onsemi.com/support/sales)

## OUR CERTIFICATE

DiGi provide top-quality products and perfect service for customer worldwide through standardization, technological innovation and continuous improvement. DiGi through third-party certification, we stricly control the quality of products and services. Welcome your RFQ to

Email: [Info@DiGi-Electronics.com](mailto:Info@DiGi-Electronics.com)



Tel: +00 852-30501935

RFQ Email: [Info@DiGi-Electronics.com](mailto:Info@DiGi-Electronics.com)

DiGi is a global authorized distributor of electronic components.