

FPF2300MX Datasheet

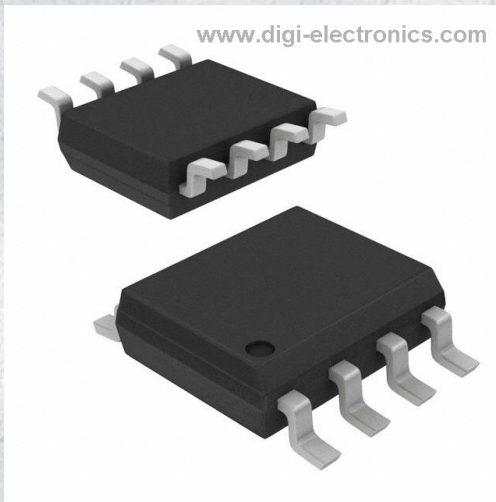

<https://www.DiGi-Electronics.com>

DiGi Electronics Part Number	FPF2300MX-DG
Manufacturer	onsemi
Manufacturer Product Number	FPF2300MX
Description	IC PWR SWITCH P-CHANNEL 1:2 8SOP
Detailed Description	Power Switch/Driver 1:2 P-Channel 1.1A 8-SOIC



Tel: +00 852-30501935

RFQ Email: Info@DiGi-Electronics.com

DiGi is a global authorized distributor of electronic components.

Purchase and inquiry

Manufacturer Product Number:

FPF2300MX

Series:

IntelliMAX™

Switch Type:

General Purpose

Ratio - Input:Output:

1:2

Output Type:

P-Channel

Voltage - Load:

1.8V ~ 5.5V

Current - Output (Max):

1.1A

Input Type:

Non-Inverting

Fault Protection:

Current Limiting (Fixed), Over Temperature, Reverse Current, UVLO

Mounting Type:

Surface Mount

Package / Case:

8-SOIC (0.154", 3.90mm Width)

Manufacturer:

onsemi

Product Status:

Obsolete

Number of Outputs:

2

Output Configuration:

High Side

Interface:

On/Off

Voltage - Supply (Vcc/Vdd):

Not Required

Rds On (Typ):

75mOhm

Features:

Auto Restart, Slew Rate Controlled, Status Flag

Operating Temperature:

-40°C ~ 85°C (TA)

Supplier Device Package:

8-SOIC

Base Product Number:

FPF2300

Environmental & Export classification

Moisture Sensitivity Level (MSL):

1 (Unlimited)

ECCN:

EAR99

REACH Status:

REACH Unaffected

HTSUS:

8542.39.0001



Is Now Part of



ON Semiconductor®

To learn more about ON Semiconductor, please visit our website at
www.onsemi.com

Please note: As part of the Fairchild Semiconductor integration, some of the Fairchild orderable part numbers will need to change in order to meet ON Semiconductor's system requirements. Since the ON Semiconductor product management systems do not have the ability to manage part nomenclature that utilizes an underscore (_), the underscore (_) in the Fairchild part numbers will be changed to a dash (-). This document may contain device numbers with an underscore (_). Please check the ON Semiconductor website to verify the updated device numbers. The most current and up-to-date ordering information can be found at www.onsemi.com. Please email any questions regarding the system integration to Fairchild_questions@onsemi.com.

ON Semiconductor and the ON Semiconductor logo are trademarks of Semiconductor Components Industries, LLC dba ON Semiconductor or its subsidiaries in the United States and/or other countries. ON Semiconductor owns the rights to a number of patents, trademarks, copyrights, trade secrets, and other intellectual property. A listing of ON Semiconductor's product/patent coverage may be accessed at www.onsemi.com/site/pdf/Patent-Marking.pdf. ON Semiconductor reserves the right to make changes without further notice to any products herein. ON Semiconductor makes no warranty, representation or guarantee regarding the suitability of its products for any particular purpose, nor does ON Semiconductor assume any liability arising out of the application or use of any product or circuit, and specifically disclaims any and all liability, including without limitation special, consequential or incidental damages. Buyer is responsible for its products and applications using ON Semiconductor products, including compliance with all laws, regulations and safety requirements or standards, regardless of any support or applications information provided by ON Semiconductor. "Typical" parameters which may be provided in ON Semiconductor data sheets and/or specifications can and do vary in different applications and actual performance may vary over time. All operating parameters, including "Typicals" must be validated for each customer application by customer's technical experts. ON Semiconductor does not convey any license under its patent rights nor the rights of others. ON Semiconductor products are not designed, intended, or authorized for use as a critical component in life support systems or any FDA Class 3 medical devices or medical devices with a same or similar classification in a foreign jurisdiction or any devices intended for implantation in the human body. Should Buyer purchase or use ON Semiconductor products for any such unintended or unauthorized application, Buyer shall indemnify and hold ON Semiconductor and its officers, employees, subsidiaries, affiliates, and distributors harmless against all claims, costs, damages, and expenses, and reasonable attorney fees arising out of, directly or indirectly, any claim of personal injury or death associated with such unintended or unauthorized use, even if such claim alleges that ON Semiconductor was negligent regarding the design or manufacture of the part. ON Semiconductor is an Equal Opportunity/Affirmative Action Employer. This literature is subject to all applicable copyright laws and is not for resale in any manner.



FPF2300/02/03

Dual-Output Current Limit Switch

June 2009

Features

- 1.8 to 5.5V Input Voltage Range
- Typical $R_{ON} = 75m\Omega$ at $I_N = 5.5V$
- 1.3A Current Limit (Typical)
- Slew Rate Controlled
- Reversed Current Blocking when Disabled
- ESD Protected, Above 4000V HBM
- Independent Thermal Shutdown
- UVLO
- RoHS Compliant

Applications

- Notebook Computing
- Peripheral USB Ports
- Networking / USB Based Equipment



Description

The FPF2300/02/03 are dual-channel load switches of IntelliMAX™ family. The FPF2300/02/03 consist of dual, independent, current-limited, slew rate controlled, P-channel MOSFET power switches. Slew rated turn-on prevents inrush current from glitching supply rails. The input voltage range operates from 1.8V to 5.5V to fulfill today's USB device supply requirements. Switch control is accomplished by a logic input (ON) capable of interfacing directly with low-voltage control signal.

For the FPF2302, if the constant current condition persists after 10ms, these parts shut down the switch and pull the fault signal pin (FLAGB) LOW. The FPF2300 has an auto-restart feature that turns the switch on again after 504ms if the ON pin is still active. For the FPF2303, a current limit condition immediately pulls the fault signal pin LOW and the part remains in the constant-current mode until the switch current falls below the current limit. For the FPF2300 through FPF2303, the current limit is typically 1.3A for each switch to align with notebook computing applications. FPF2300/02/03 is available in both SO8 and MLP 3X3mm 8-lead packages.

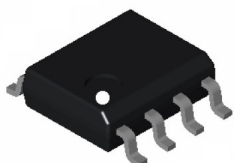

Figure 1. 8-Lead SOP

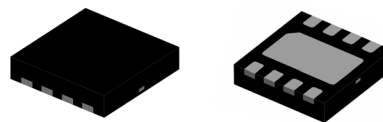

Figure 2. 8-Lead MLP (3x3mm)

Ordering Information

Part Number	Minimum Current Limit	Current Limit Blanking Time	Eco Status	Auto Restart	ON Pin Activity	Mode	Package
FPF2300MX	1100mA	10ms	RoHS	504ms	Active LOW	Restart	8-Lead SO8
FPF2302MX	1100mA	10ms	RoHS	N/A	Active LOW	Latch Off	8-Lead SO8
FPF2303MX	1100mA	0ms	RoHS	N/A	Active LOW	Constant Current	8-Lead SO8
FPF2300MPX	1100mA	10ms	Green	504	Active LOW	Restart	8-Lead Molded Leadless Package (MLP)
FPF2302MPX	1100mA	10ms	Green	N/A	Active LOW	Latch Off	8-Lead Molded Leadless Package (MLP)
FPF2303MPX	1100mA	0ms	Green	N/A	Active LOW	Constant Current	8-Lead Molded Leadless Package (MLP)



For Fairchild's definition of Eco Status, please visit: http://www.fairchildsemi.com/company/green/rohs_green.html.

Application Circuit

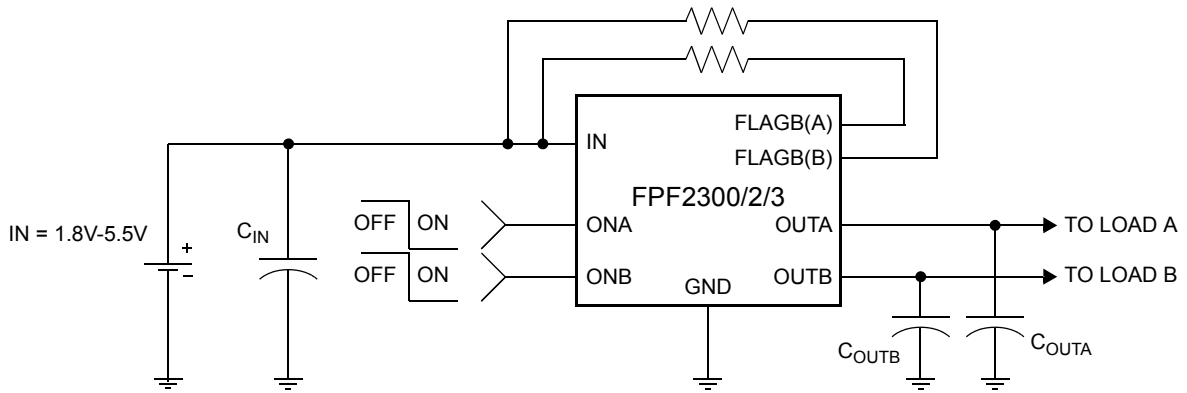

Figure 3. Typical Application

Functional Block Diagram

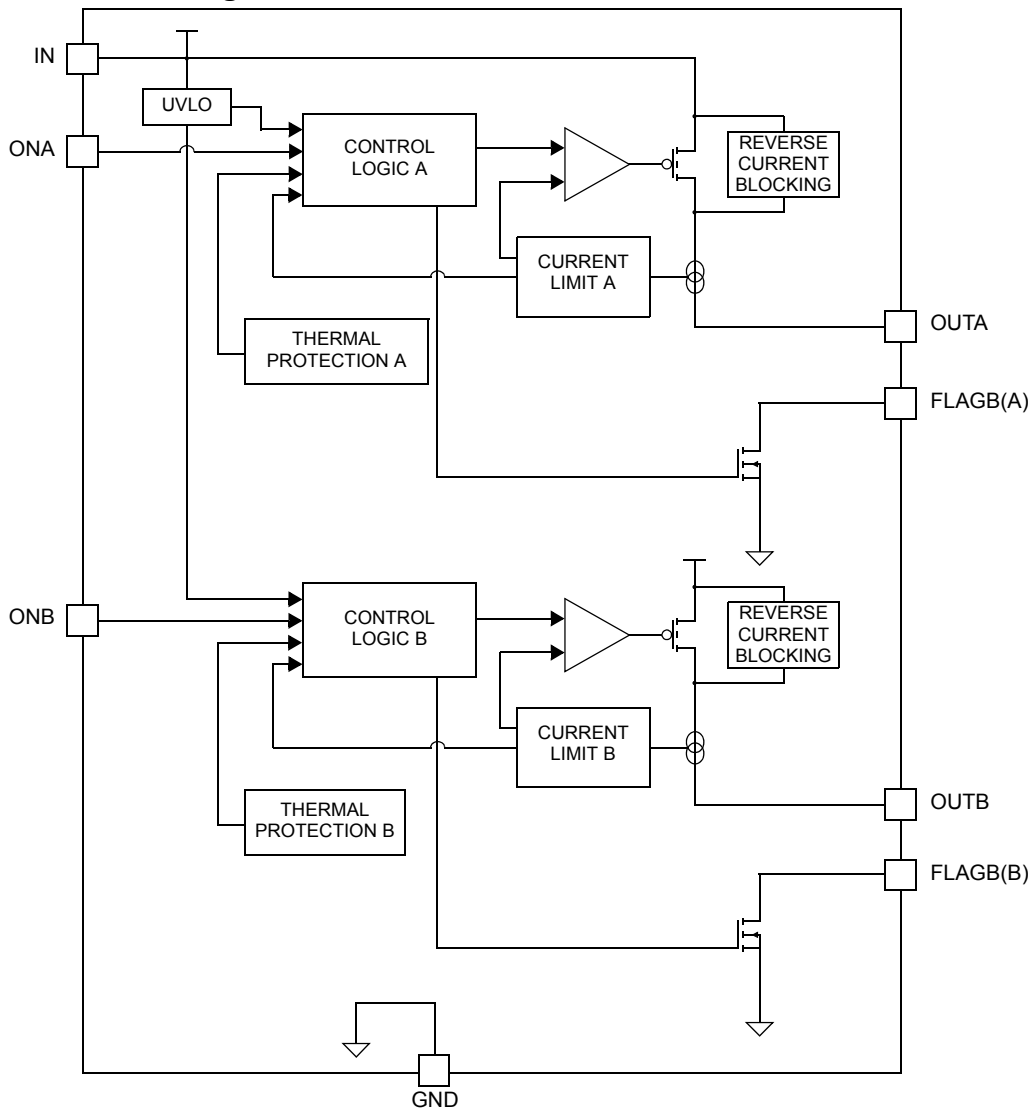

Figure 4. Block Diagram

Pin Configuration

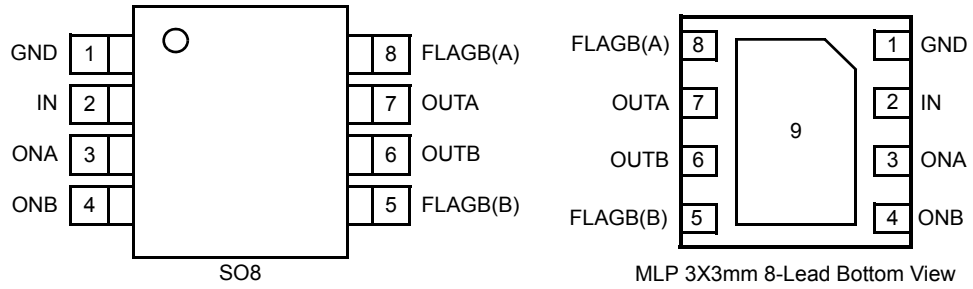

Figure 5. Pin Configurations

Pin Description

Pin #	Name	Function
1	GND	Ground
2	IN	Supply Input: Input to the power switch and the supply voltage for the IC.
3	ONA	ON / OFF control input of power switch A. Active LOW
4	ONB	ON / OFF control input of power switch B. Active LOW
5	FLAGB(B)	Fault Output B, Active LO, open drain output which indicates an over supply, UVLO and thermal shutdown.
6	OUTB	Switch Output: Output of the power switch B
7	OUTA	Switch Output: Output of the power switch A
8	FLAGB(A)	Fault Output A, Active LO, open drain output which indicates an over supply, UVLO and thermal shutdown.
9(MLP)	Thermal Pad	IC Substrate, which can be connected to GND for better thermal performance. Do not connect to other pins.

Absolute Maximum Ratings

Stresses exceeding the absolute maximum ratings may damage the device. The device may not function or be operable above the recommended operating conditions and stressing the parts to these levels is not recommended. In addition, extended exposure to stresses above the recommended operating conditions may affect device reliability. The absolute maximum ratings are stress ratings only.

Symbol	Parameter	Min.	Max.	Unit
	IN, OUTA, OUTB, ONA, ONB, FLAGB(A), FLAGB(B) to GND	-0.3	6.0	V
P _D	Power Dissipation	SO8	0.8 ⁽¹⁾	W
			1.4 ⁽²⁾	
		MLP	0.6 ⁽³⁾	
			2.2 ⁽⁴⁾	
T _{STG}	Storage Temperature	-65	+150	°C
θ _{JA}	Thermal Resistance, Junction-to-Ambient	SO8	158 ⁽¹⁾	°C/W
			92 ⁽²⁾	
		MLP	216 ⁽³⁾	
			57 ⁽⁴⁾	
ESD	Electrostatic Discharge Protection	Human Body Model, JESD22-A114	4000	V
		Charged Device Model, JESD22-C101	2000	

Notes:

- Two-layer PCB of 2s0p from JEDEC STD 51-3.
- Four-layer PBD of 2s0p from JEDEC STD 51-7.
- Soldered thermal pad on a two-layer PCB without vias based on JEDEC STD 51-3.
- Soldered thermal pad on a four-layer with two vias connected with GND plane base on JEDEC STD 51-5, 7.

Recommended Operating Range

The Recommended Operating Conditions table defines the conditions for actual device operation. Recommended operating conditions are specified to ensure optimal performance to the datasheet specifications. Fairchild does not recommend exceeding them or designing to absolute maximum ratings.

Symbol	Parameter	Min.	Max.	Unit
IN	Supply Input	1.8	5.5	V
T _A	Ambient Operating Temperature	-40	+85	°C

Electrical Characteristics

IN = 1.8 to 5.5V, TA = -40 to +85°C unless otherwise noted. Typical values are at IN = 3.3V and TA = 25°C.

Symbol	Parameter	Conditions	Min.	Typ.	Max.	Units
Basic Operation						
V _{IN}	Operating Voltage		1.8		5.5	V
I _Q	Quiescent Current	IN = 5.5V, V _{ONA} = V _{ONB} = 0V, I _{OUT} = 0mA		52.5	94.5	μA
I _{SD}	IN Shutdown Current	V _{ONA} = V _{ONB} = 5.5V, IN = 5.5V OUTA = OUTB = Short to GND,			3	μA
R _{ON}	On Resistance	IN = 5.5V, I _{OUT} = 200mA, T _A = 25°C		75	140	mΩ
		IN = 5.5V, I _{OUT} = 200mA, T _A = -40°C to 85°C		90		
V _{IH}	ON Input Logic High Voltage (ON)	IN = 1.8V	0.8			V
		IN = 5.5V	1.4			
V _{IL}	ON Input Logic Low Voltage	IN = 1.8V			0.5	V
		IN = 5.5V			0.9	
I _{ON}	ON Input Leakage	V _{ON} = IN or GND	-1		1	μA
	FLAGB Output Logic Low Voltage	IN = 5.5V, I _{SINK} = 1mA		0.1	0.2	V
		IN = 1.8V, I _{SINK} = 1mA		0.15	0.30	
	FLAGB Output High Leakage Current	IN = V _{ON} = 5V			1	μA
Protections						
I _{LIM}	Current Limit	IN = 3.3V, V _{OUTA} = V _{OUTB} = 3V, T _A = 25°C	1.1	1.3	1.5	A
TSD	Thermal Shutdown	Shutdown Threshold		140		°C
		Return from Shutdown		130		
		Hysteresis		10		
V _{UVLO}	Under-Voltage Shutdown	IN Increasing	1.55	1.65	1.75	V
V _{UVLO_HYS}	Under-Voltage Shutdown Hysteresis			50		mV
Dynamic						
t _{ON}	Turn-On Time	R _L = 500Ω, C _L = 0.1μF		113.5		μs
t _{OFF}	Turn-Off Time	R _L = 500Ω		6		μs
t _R	OUTA, OUTB Rise Time	R _L = 500Ω, C _L = 0.1μF		13.5		μs
t _{BLANK}	Over-Current Blanking Time	FPF2300, FPF2302	5	10	20	ms
t _{RSTRT_BLANK}	Startup FLAGB Blanking Time	FPF2303 ⁽⁵⁾	5	10	20	ms
t _{RSRT}	Auto-Restart Time	FPF2300		504		ms
t _{CLR}	Current Limit Response Time	IN = 3.3V, Moderate Over-Current Condition		20		μs

Note:

- FPF2303 has a 10ms startup FLAGB blanking time when the part is turned on via the ON pin to ensure transient load currents settle.

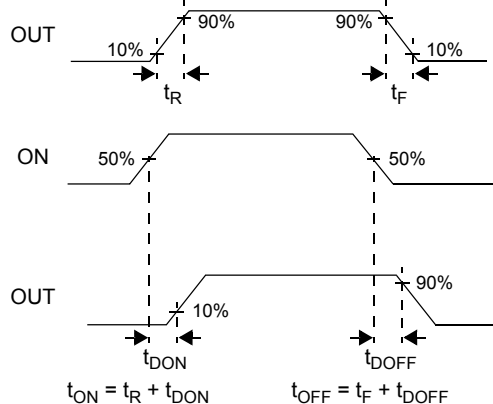

Figure 6. Timing Diagram

Typical Characteristics

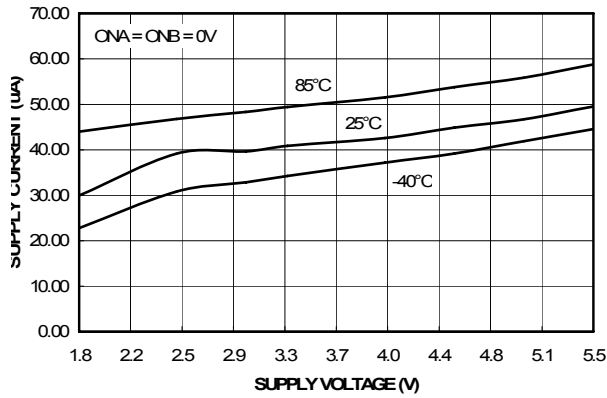

Figure 7. Quiescent Current vs. Supply Voltage

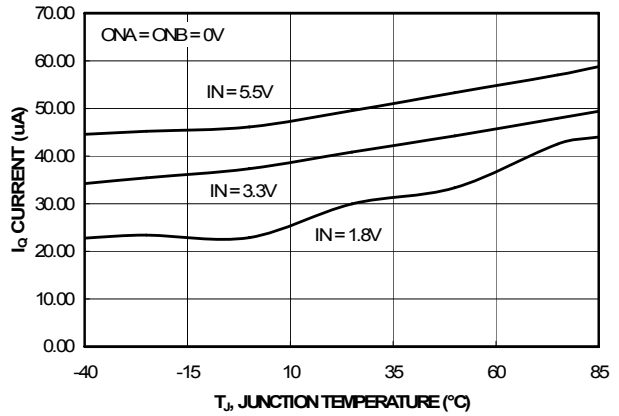

Figure 8. Quiescent Current vs. Temperature

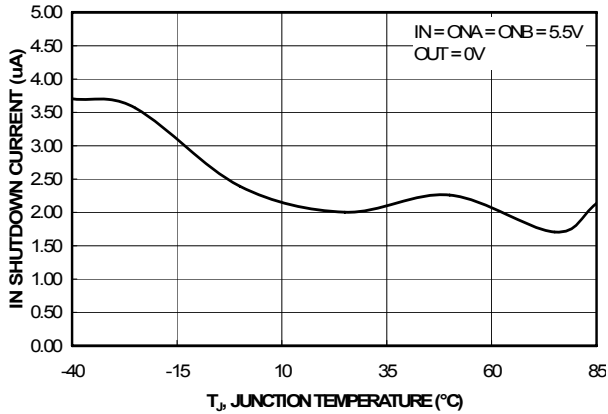

Figure 9. IN Shutdown Current vs. Temperature

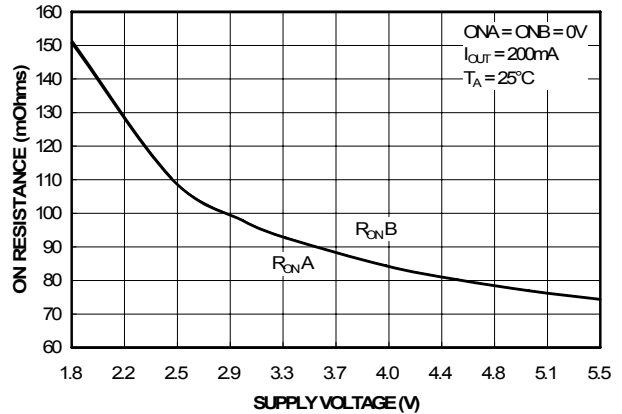

Figure 10. RON vs. Supply Voltage (MLP)

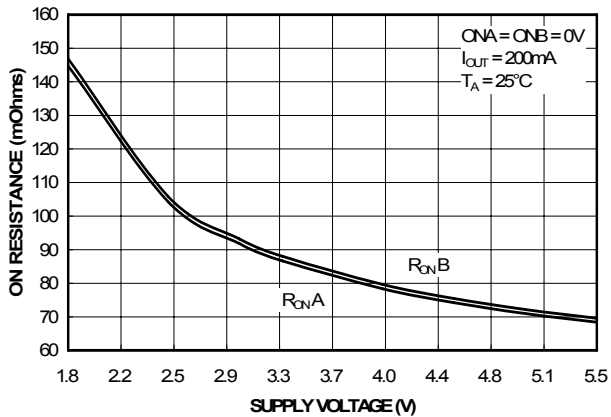

Figure 11. RON vs. Temperature (SO8)

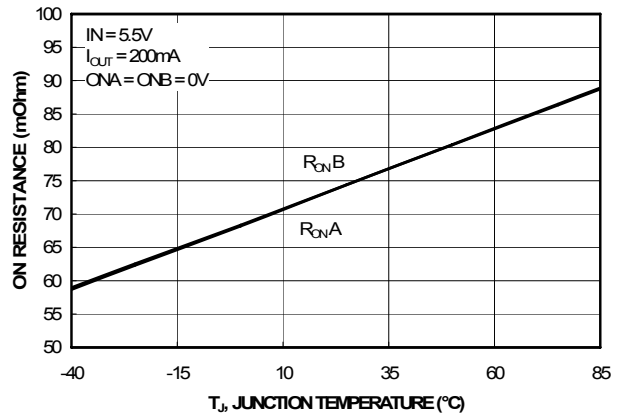

Figure 12. RON vs. Temperature (MLP)

Typical Characteristics

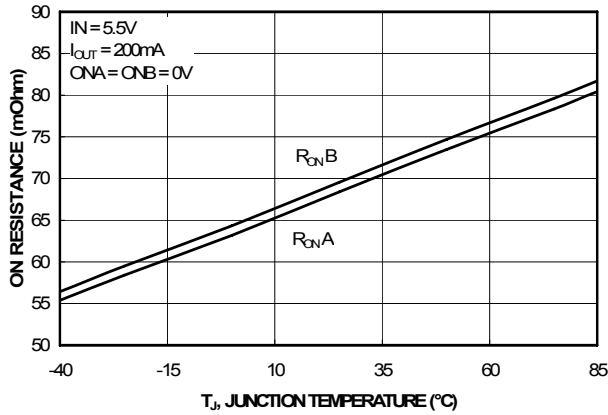

Figure 13. R_{ON} vs. Temperature (SO8)

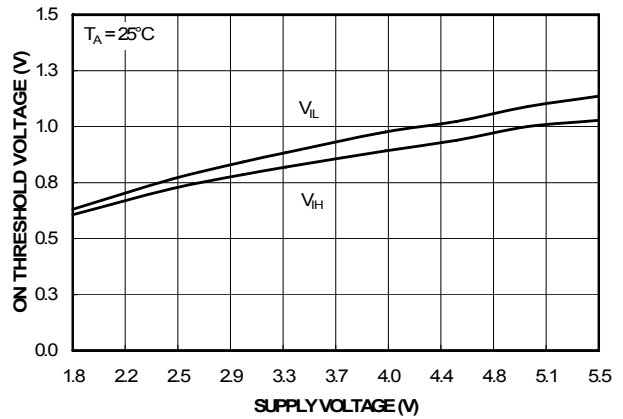

Figure 14. ON Threshold Voltage vs. Supply Voltage

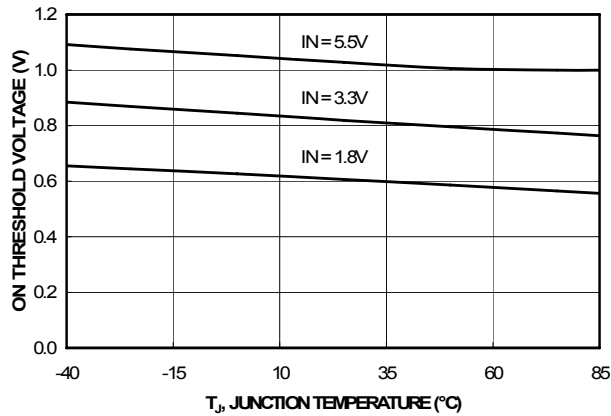

Figure 15. ON High Voltage vs. Temperature

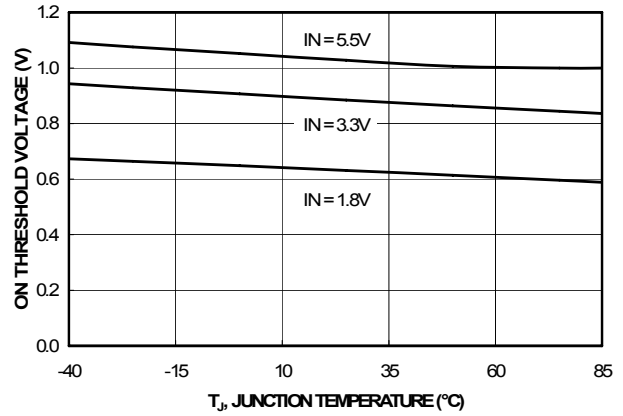

Figure 16. ON Low Voltage vs. Temperature

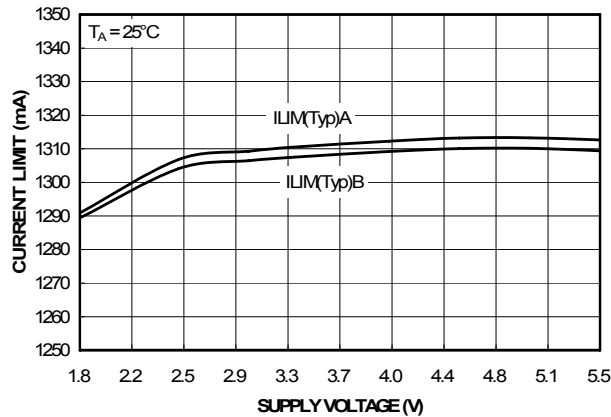

Figure 17. Current Limit vs. Supply Voltage

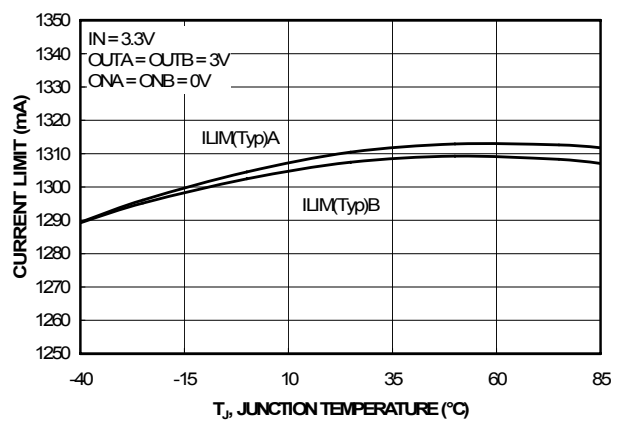

Figure 18. Current Limit vs. Temperature

Typical Characteristics

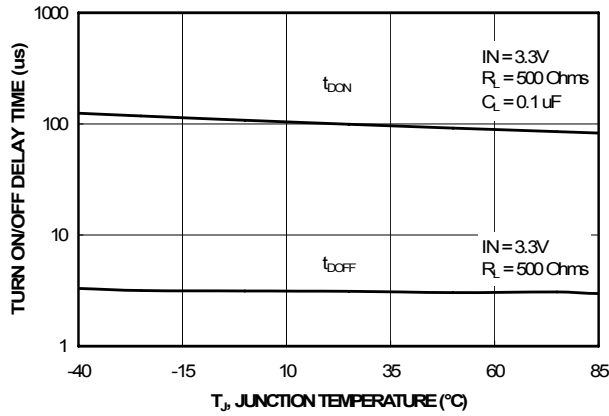

Figure 19. t_{DON} / t_{DOFF} vs. Temperature

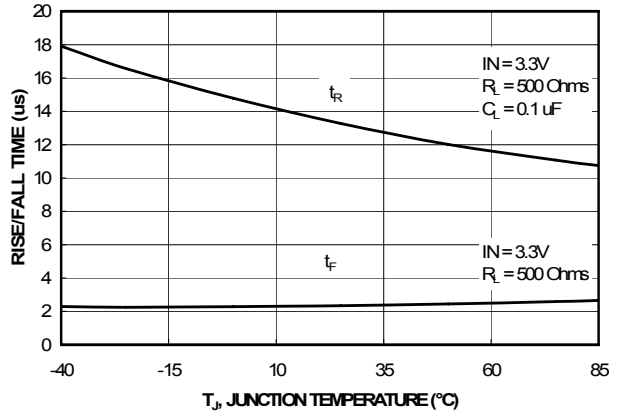

Figure 20. t_{RISE} / t_{FALL} vs. Temperature

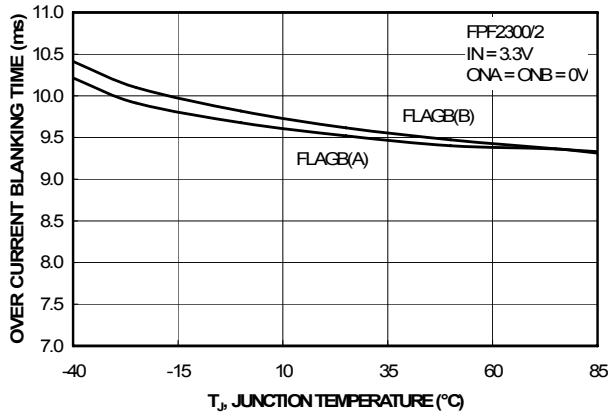

Figure 21. t_{BLANK} vs. Temperature

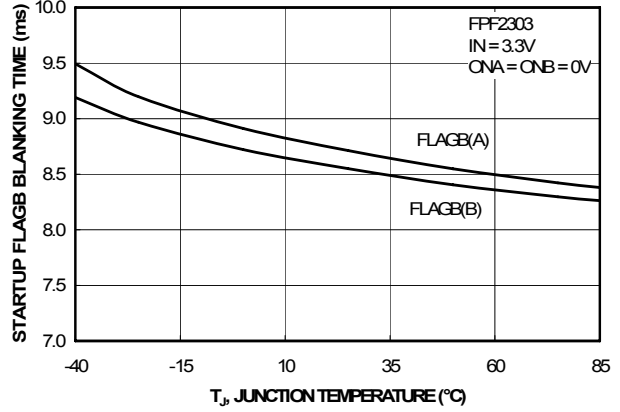

Figure 22. t_{RSTRT_BLANK} vs. Temperature

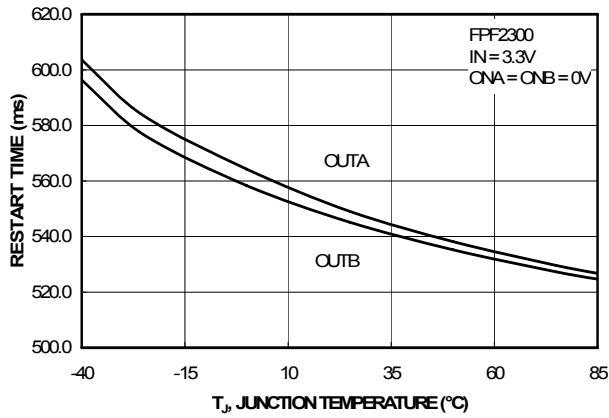

Figure 23. t_{RSTRT} vs. Temperature

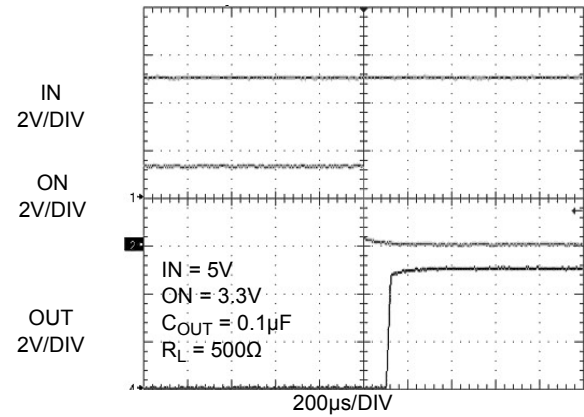

Figure 24. t_{ON} Response

Typical Characteristics

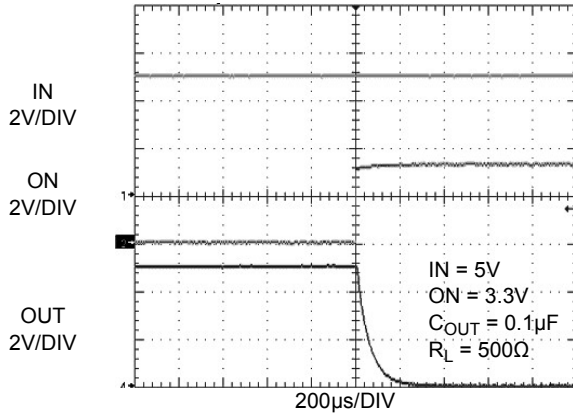

Figure 25. t_{OFF} Response

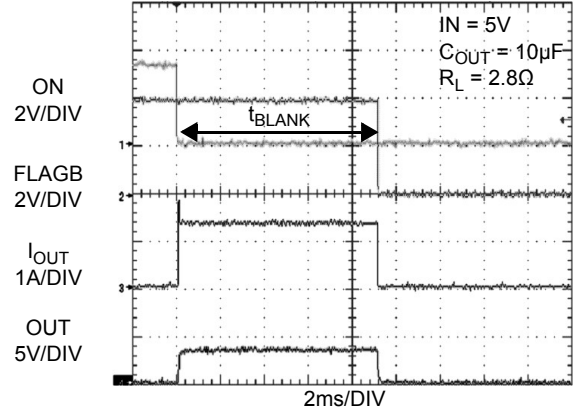

Figure 26. Over-Current Blanking Time (FPF2300/2)

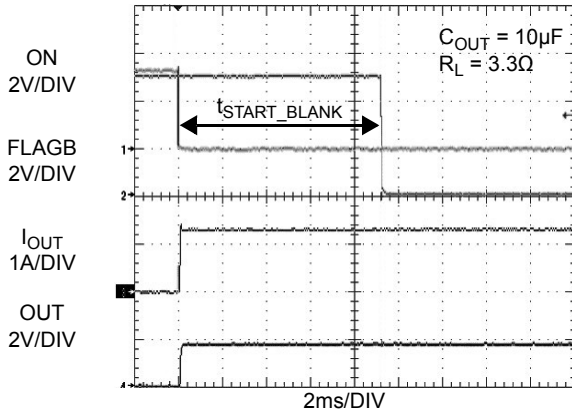

Figure 27. Startup FLAGB Blanking Time (FPF2303)

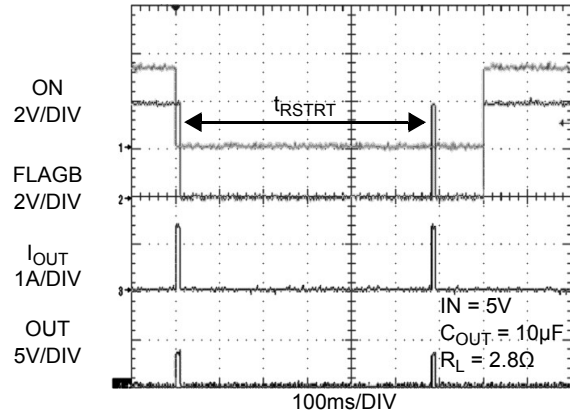

Figure 28. Auto-Restart Time (FPF2300)

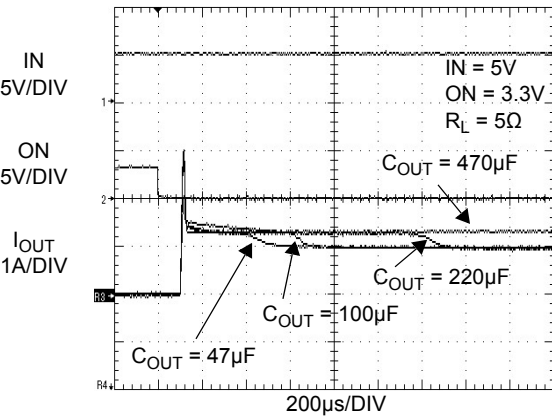

Figure 29. Current Limit at Startup with Different Output Capacitor

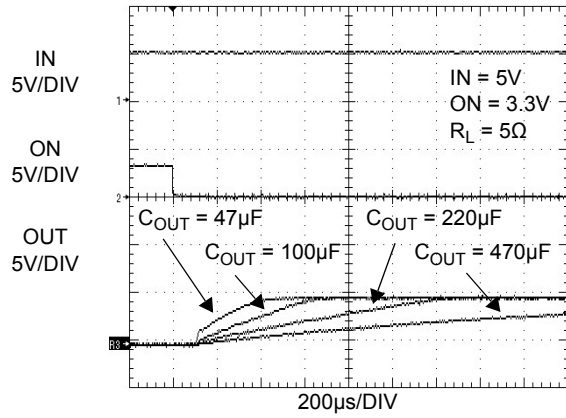

Figure 30. Output Voltage at Startup with Different Output Capacitor

Typical Characteristics

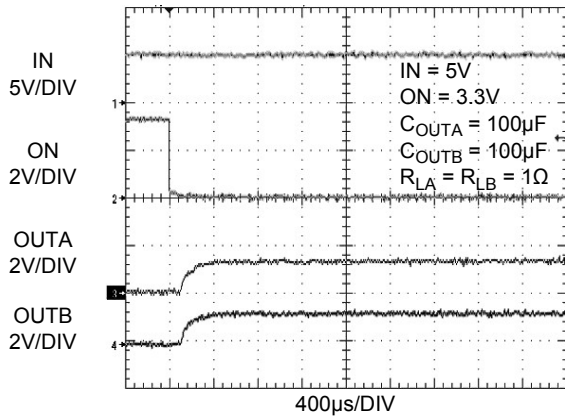

Figure 31. Current Limit Response Time Both Channels are in OC

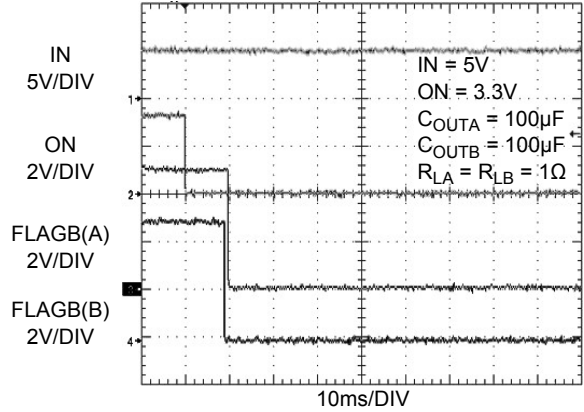

Figure 32. Startup FLAGB Blanking Time

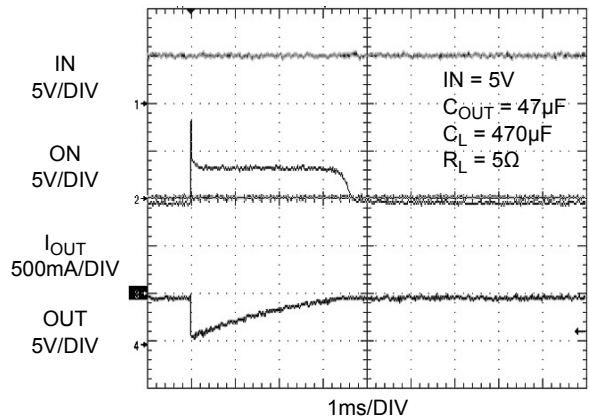

Figure 33. Inrush Response During Capacitive Load Hot Plug-In Event

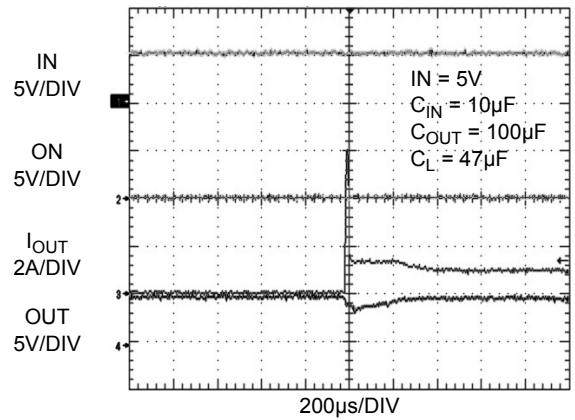

Figure 34. Inrush Response During Capacitive and Resistive Load Hot Plug-In Event

Description of Operation

The FPF2300, FPF2302, and FPF2303 are dual-output current-limit switches designed to meet notebook computer, peripheral USB port, and point-of-load (POL) application power requirements. Dual-output current can be used where dual or quad USB ports are powered by hosts or self-powered hubs. The FPF230X family offers control and protection while providing optimum operation current for a safe design practice. The core of each switch is a typical 75mΩ (IN = 5.5V) P-channel MOSFET and a controller capable of functioning over an input operating range of 1.8-5.5V. The FPF230X family offers current limiting, UVLO (under-voltage lockout), and thermal shutdown protection per each switch. In the event of an over-current condition, the load switch limits the load to current limit value. The minimum current limit is set to 1100mA.

On/Off Control

The ON pin is active LOW for FPF2300/2/3 and controls the state of the switch. Pulling the ON pin continuous to LOW holds the switch in the ON state. The switch moves into the OFF state when the ON pin is pulled HIGH or if a fault is encountered. For all versions, an under-voltage on input voltage or a junction temperature in excess of 140°C overrides the ON control to turn off the switch. In addition, excessive currents cause the switch to turn off in the FPF2300 and FPF2302 after a 10ms blanking time. The FPF2300 has an auto-restart feature that automatically turns the switch ON again after 504ms. For the FPF2302, the ON pin must be toggled to turn on the switch again. The FPF2303 does not turn off in response to an over-current condition, but remains operating in a constant-current mode as long as ON is enabled and the thermal shutdown or UVLO is not activated. The ON pin does not have a pull-up resistor or pull-up resistor and should not be left floating.

Current Limiting

The current limit ensures that the current through the switch doesn't exceed a maximum value, while not limiting at less than a minimum value. FPF230X family has dual-output load switches being housed in one package. The minimum current at which both switches start limiting the load current is set to 1100mA. The FPF2300 and FPF2302 have a blanking time of 10ms (typical), during which the switch acts as a constant current source. At the end of the blanking time, the switch is turned off. The FPF2303 has no current limit blanking period, so it remains in a constant current state until the ON pin of the affected switch is deactivated or the thermal shutdown turns off the switch.

Fault Reporting

Over-current, input under-voltage, and over-temperature fault conditions are signaled out by the FLAGB pin going LOW. A UVLO fault is reported on both FLAGB(A) and FLAGB(B) simultaneously, while over-current and over-temperature condition faults are reported independently. FPF2300 and FPF2302 have a current fault blanking feature that prevents over-current faults shorter than the blanking time ($t_{BLANK(Typ)} = 10ms$) from triggering the fault signal (FLAGB) output.

If the over-current condition persists beyond the blanking time, the FPF2300 pulls the FLAGB pin LOW and shuts the switch off. If the ON pin is kept active, an auto-restart feature releases the FLAGB pin and turns the switch on again after a 504ms auto-restart time (t_{RSTRT}). If the over-current condition persists beyond the blanking time, the FPF2302 has a latch-off feature that pulls the FLAGB pin LOW and shuts the switch off. The switch is kept off and the FLAGB pin kept LOW until the ON pin is toggled. The FPF2303 responds to an overload condition by immediately pulling the FLAGB pin LOW and the switch remains in constant current mode until the output overload condition is removed. The FPF2303 has a

startup blanking feature that prevents current faults related to startup transients from triggering the FLAGB output. The startup blanking feature is effective for the first 10ms (typical) following device turn-on via ON pin.

The FLAGB outputs are two open-drain MOSFETs that require a pull-up resistor on each FLAGB pin. FLAGB can be pulled HIGH to a voltage source other than input supply with maximum 5.5V. A 100KΩ pull-up resistor is recommended. When the ON pin is inactive, the FLAGB is disabled to reduce current draw from the supply. If the FLAGB is not used, the FLAGB can be connected to ground on the PCB.

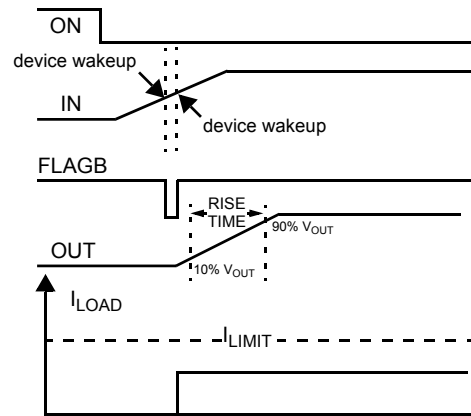

Figure 35. FLAGB Assertion in Under-Voltage Fault

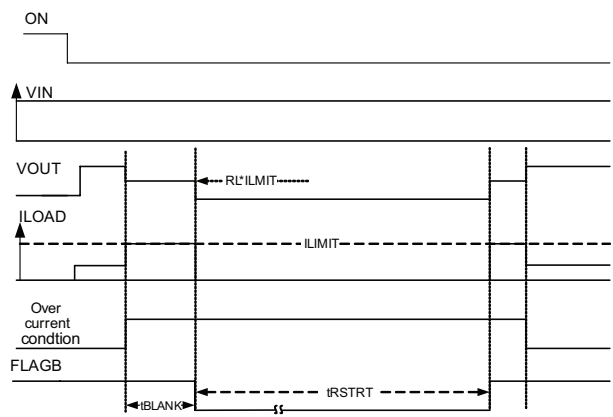

Figure 36. FPF2300 FLAGB Reports While Entering into an Over-Current Condition

Note:

- An over-current condition signal loads the output with a heavy load current larger than I_{LIM} value.

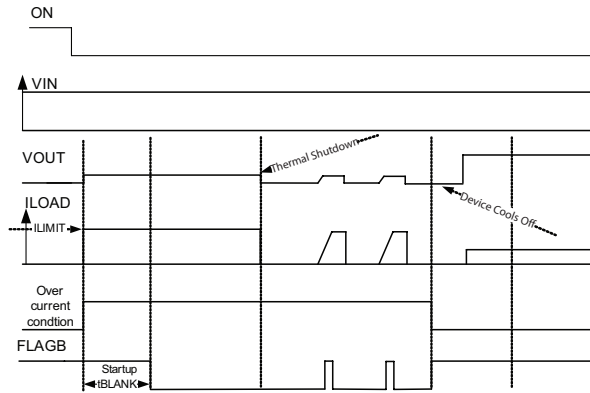

Figure 37. FPF2300 FLAGB While and Over-Current Condition is Applied

Note:

- An over-current condition signal loads the output with a heavy load current larger than I_{LIMIT} value.

Under-Voltage Lockout (UVLO)

The under-voltage lockout feature turns off the switch if the input voltage drops below the under-voltage lockout threshold. With the ON pin active (ON pin pulled LOW), the input voltage rising above the under-voltage lockout threshold causes a controlled turn-on of the switch and limits current overshoot. If a device is in UVLO condition, both FLAGBs go LOW and indicate the fault condition. The device detects the UVLO condition when input voltage goes below UVLO voltage, but remains above 1.3V (typical).

Reverse Current Blocking

Each switch of FPF2300/2/3 has an independent reverse current blocking feature that protects input source against current flow from output to input. For a standard USB power design, this is an important feature that protects the USB host from being damaged due to reverse current flow on V_{BUS} . To activate the reverse current blocking, the switch must be in OFF state (ON pins inactivated) so that no current flows from the output to the input. The FLAGB operation is independent of the reverse current blocking and does not report a fault condition if this feature is activated.

Thermal Shutdown

The thermal shutdown protects the device from internally or externally generated excessive temperatures. Each switch has an individual thermal shutdown protection function and operates independently as adjacent switch temperatures increase above 140°C. If one switch is in normal operation and shutdown protection of second switch is activated, the first channel continues to operate if the affected channel's heat stays confined. The over-temperature in one channel can shut down both switches due to rapidly generated excessive load currents resulting in very high power dissipation. Generally, a thermally improved board layout can provide heat sinking and allow heat to stay confined and not affect the second switch operation.

During an over-temperature condition, the FLAGB is pulled LOW and the affected switch is turned off. If the temperature of the die drops below the threshold temperature, the switch

automatically turns on again. To avoid unwanted thermal oscillations, a 10°C (typical) thermal hysteresis is implemented between thermal shutdown entry and exit temperatures.

If output of both switches are connected together and an excessive load current activates thermal protection of both, the controller can shut down the switches after both FLAGB outputs go LOW and turn on both channels again. This provides simultaneous switch turn on. Thermal protection is for device protection and should not be used as regular operation.

Input Capacitor

To limit the voltage drop on the input supply caused by transient inrush currents when the switch is turned on into discharged load capacitors or a short-circuit; an input capacitor, C_{IN} , is recommended between IN and GND. The FPF2310/2/3/3L features a fast current limit response time of 20µs. An inrush current (also known as surge current) could occur during the current limit response time while the switch is responding to an over-current condition caused by large output capacitors. A 10µF ceramic capacitor, C_{IN} , is required to provide charges for the inrush current and prevent input voltage drop at turn on. Higher values of C_{IN} can be used to further reduce voltage drop.

Output Capacitor

A 0.1µF to 1µF capacitor, C_{OUT} , should be placed between the OUT and GND pins. This capacitor prevents parasitic board inductances from forcing output voltage below GND when the switch turns off. This capacitor should have a low dissipation factor. An X7R MLCC (Multilayer Ceramic Chip) capacitors is recommended.

For the FPF2300 and FPF2302, the total output capacitance needs to be kept below a maximum value, $C_{OUT(MAX)}$, to prevent the part from registering an over-current condition beyond the blanking time and shutdown. The maximum output capacitance for a given input voltage can be determined from the following:

$$C_{OUT(MAX)} = \frac{I_{LIM(MIN)} \times t_{BLANK(MIN)}}{V_{IN}} \quad (1)$$

For example, in a 5V application, $C_{OUT(MAX)}$ can be determined as:

$$C_{OUT(MAX)(IN = 5V)} = \frac{1.1A \times 5ms}{5} \quad (2)$$

$$= 1.1mF$$

Application Information

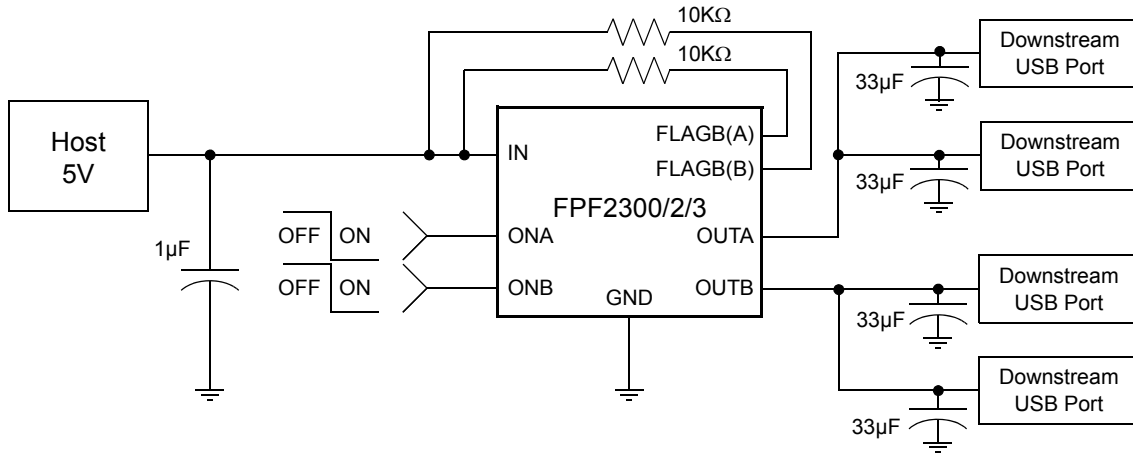

Figure 38. Self Powered 4-Port USB Hub Using a Single FPF230X

FPF230X is designed to simplify USB port power design based on self-powering USB host/hub applications. A self-powering USB port is powered by a local 5V power supply, not by an upstream port. Each port should supply at least 500mA to each downstream function based on USB 2.0 specification. Implementation can depend on the number of USB ports and current

capability per port required in actual power designs. FPF230X has 1.1A minimum current limit per output, which can cover two ports, as shown in Figure 38. Four USB ports can be implemented with a single FPF230X part and current limiting is provided based on a two-port basis for a cost-effective solution.

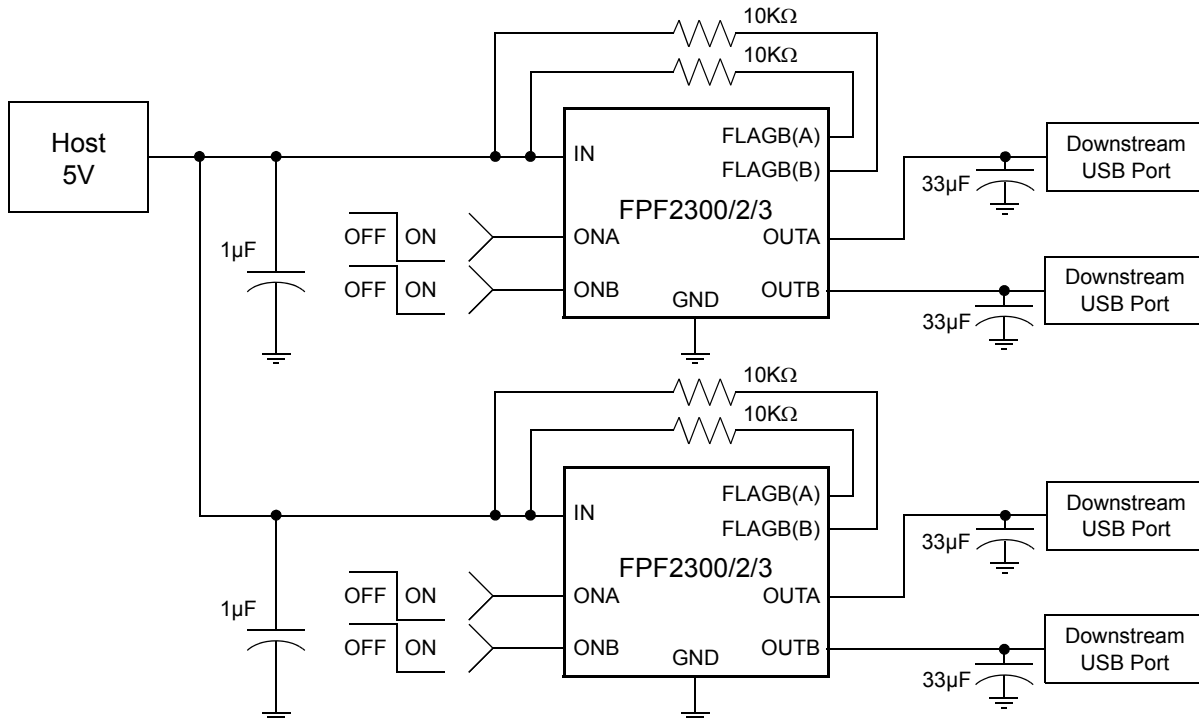

Figure 39. Individual Port Power Management for Self-Powered 4-Port USB Hub

In Figure 39, each USB port is connected with each output. Four USB ports can be implemented with two FPF230X parts. Current limiting and control are provided based on a single port.

Current capability per port has more headroom; up to a minimum of 1.1A per port.

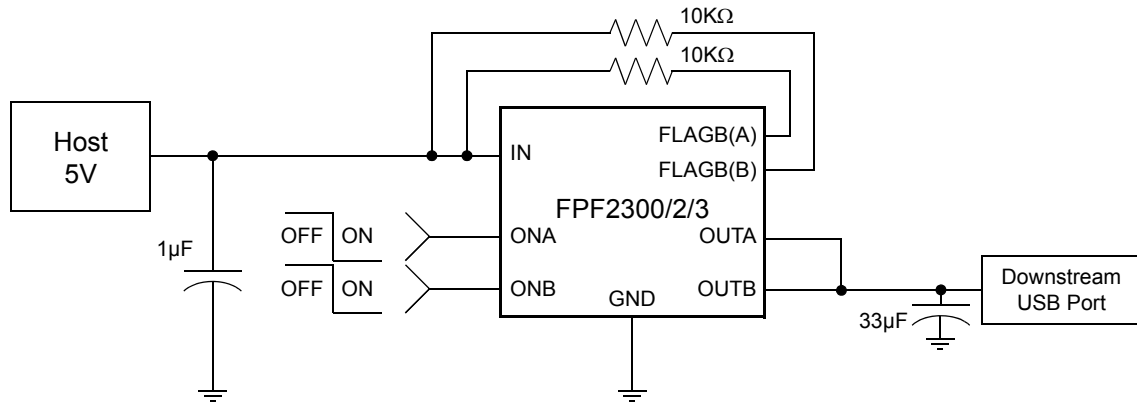

Figure 40. Self-Powered USB Port for High Current Demand

High current, over 2A, is sometimes required to supply enough power to downstream functions. As shown in Figure 40, a 2.2A

minimum load current can be achieved by tying dual outputs together.

Power Dissipation

During normal operation as a switch, the power dissipation of the device is small and has little effect on the operating temperature of the part. The maximum power dissipation for both switches while the switch is in normal operation occurs just before both channels enter into current limit. This may be calculated using the formula:

$$P_{D_MAX(Normal\ Operation)} = 2 \times (I_{LIM(MIN)})^2 \times R_{ON(MAX)} \quad (3)$$

For example, for a 5V application, maximum normal operation power loss while both switches delivering output current up to 1.1A, can be calculated as:

$$P_{D_MAX(Normal\ Operation)(IN = 5V)} = 2 \times (1.1)^2 \times 0.14 = 338mW \quad (4)$$

The maximum junction temperature should be limited to 125°C under normal operation. Junction temperature can be calculated using the formula below:

$$T_J = P_D \times R_{\theta JA} + T_A \quad (5)$$

where:

- T_J is junction temperature;
- P_D is power dissipation across the switch;
- R_{θJA} is thermal resistance junction to ambient of the package;
- T_A is ambient temperature.

For the example, T_{J(MAX)(Normal operation)} for an SO8 package with T_A=25°C while both switches are delivering up to 1.1A is calculated as:

$$T_{J(MAX)(Normal\ Operation)} = P_{D_MAX(Normal\ Operation)(IN = 5V)} \times 125 + 25 = 78.4^\circ C \quad (6)$$

If the part goes into current limit, the maximum power dissipation occurs when the output of switch is shorted to ground. For the FPF2300 the power dissipation scales with the auto-restart time, t_{RSTRT}, and the over-current blanking time, t_{BLANK}. In this case, the maximum power dissipated for the FPF2300 is::

$$P_{D_MAX(CurrentLimit)} = 2 \times \frac{t_{BLANK}}{t_{BLANK} + t_{RSTRT}} \times I_{N(MAX)} \times I_{LIM(MAX)} \quad (7)$$

which results in:

$$P_{D_MAX(CurrentLimit)} = 2 \times \frac{10}{10 + 504} \times 5.5 \times 1.5 = 321mW \quad (8)$$

Note that this is below the maximum package power dissipation and the thermal shutdown feature protection provides additional safety to protect the part from damage due to excessive heating. The junction temperature is only able to increase to the thermal shutdown threshold. Once this temperature has been reached, toggling ON has no affect until the junction temperature drops below the thermal shutdown exit temperature. For the FPF2303, a short on both outputs causes both switches to operate in a constant current state and dissipate a worst-case power of:

$$P_{MAX} = 2 \times I_{N(MAX)} \times I_{LIM(MAX)} = 2 \times 5.5 \times 1.5 = 16.5\ W \quad (9)$$

As both FPF2303 outputs are connected to GND.

This power dissipation is significant and activates both thermal shutdown blocks and the part can cycle in and out of thermal shutdown as long as the ON pin is activated (pulled LOW) and the output short is present.

PCB Layout Recommendations

For the best performance, all traces should be as short as possible. To be most effective, the input and output capacitors should be placed close to the device to minimize the effects that parasitic trace inductances may have on normal and short-circuit operation. Using wide traces for IN, OUTs, and GND pins helps minimize parasitic electrical effects and the case-to-ambient thermal impedance.

Improving Thermal Performance

Improper layout could result in higher junction temperature and triggering the thermal shutdown protection feature. This concern is particularly significant for the FPF2303, where both channels operate in constant current mode in the overload conditions and during fault condition the outputs are shorted, resulting in large voltage drop across switches. In this case, power dissipation of the switch ($P_D = (V_{IN} - V_{OUT}) \times I_{LIM(MAX)}$) could exceed the maximum absolute power dissipation of part.

The following techniques improve the thermal performance of this family of devices. These techniques are listed in order of the significance of impact.

1. Thermal performance of the load switch can be improved by connecting the DAP (Die Attach Pad) of MLP 3x3mm package to the GND plane of the PCB.
2. Embedding two exposed through-hole vias into the DAP (pin 9) provides a path for heat to transfer to the back GND plane of the PCB. A drill size of round, 15 mils (0.4mm), with 1-ounce copper plating is recommended to create appropriate solder reflow. A smaller size hole prevents the solder from penetrating into the via, resulting in device lift-up. Similarly, a larger via hole consumes excessive solder and may result in voiding of the DAP.

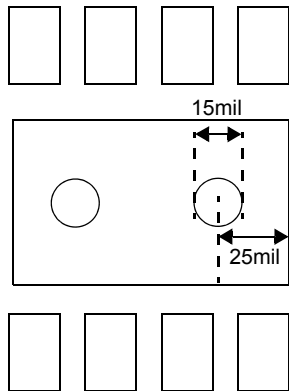

Figure 41. Two Through-Hole Open Vias Embedded in DAP

3. The IN, OUTs, and GND pins dissipate most of the heat generated during a high load current condition. Figure 42 illustrates a proper layout for devices in MLP 3x3mm packages. IN, OUTs, and GND pins are connected to adequate copper so heat may be transferred as efficiently as possible out of the device. The low-power FLAGB and ON pin traces may be laid out diagonally from the device to maximize the area available to the ground pad. Placing the input and output capacitors as close to the device as possible also contributes to heat dissipation, particularly during high load currents.

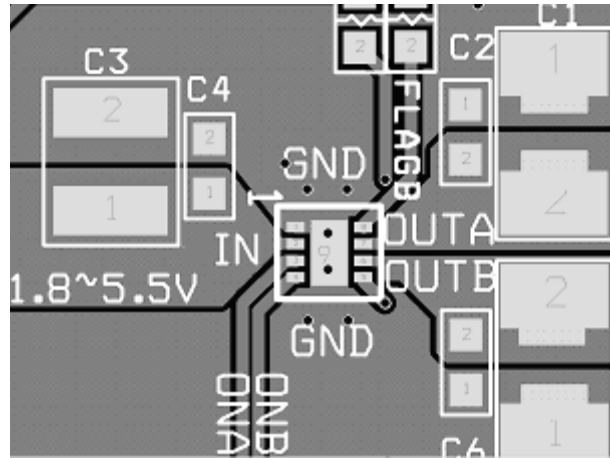

Figure 42. Proper Layout of Output and Ground Copper Area

FPF230X Evaluation Board

The FPF230X evaluation board has components and circuitry to demonstrate FPF2300/2/3 load switch functions and features, accommodating both the MLP 3x3mm and SO8 packages. The state of the each channel can be configured using J1 and J2 jumpers. In addition, both channels can be controlled by ONA and ONB test pints. Thermal performance of the board is improved using techniques in the layout recommendations section. R3 and R4 resistors are used on the board to sink a light load current when switches are activated.

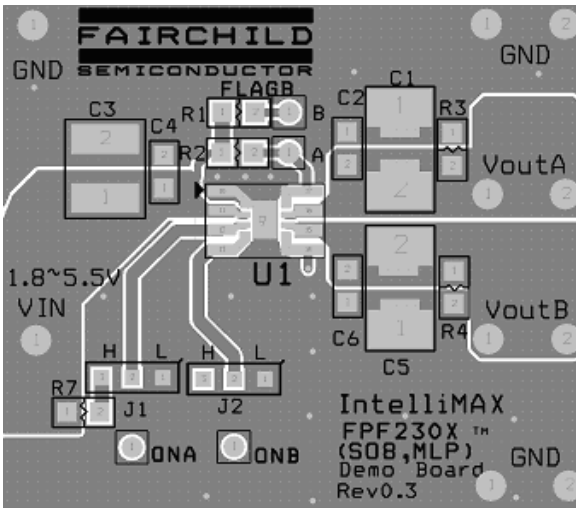

Figure 43. Top, SST and AST Layers (MLP 3x3mm and SO8)

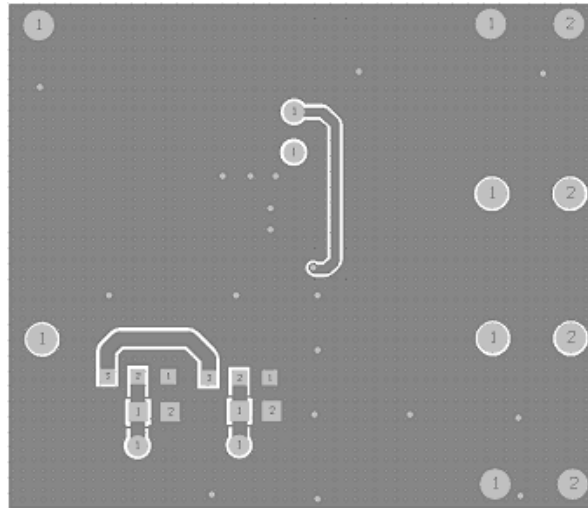

Figure 44. Bottom and ASB Layers

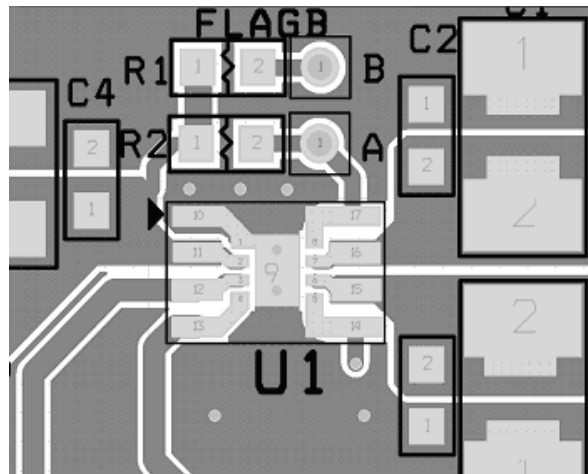
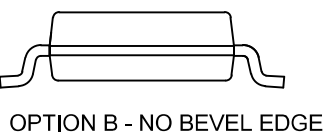
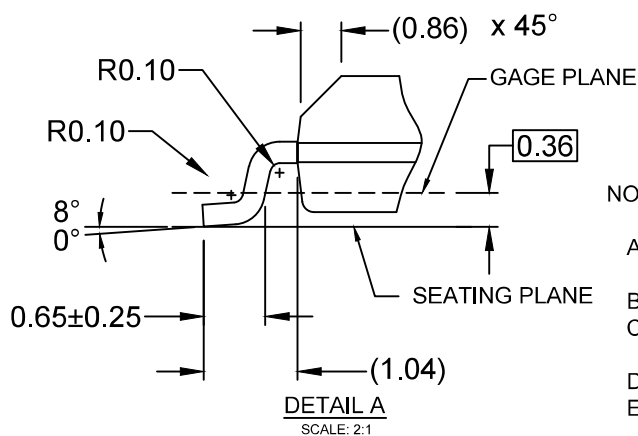
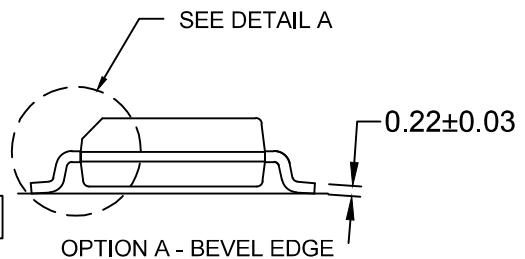
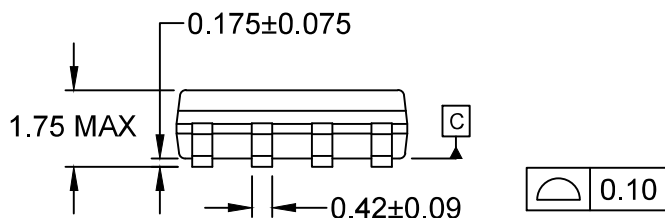
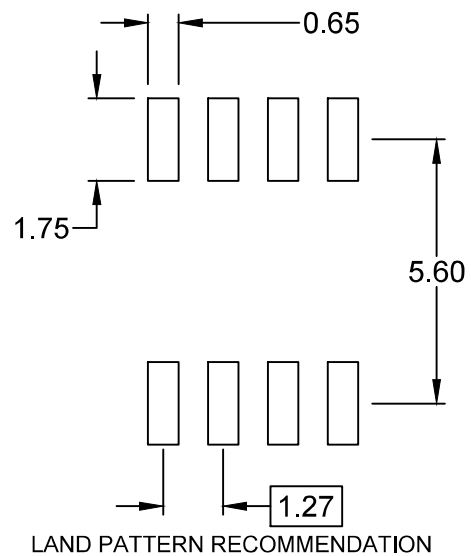
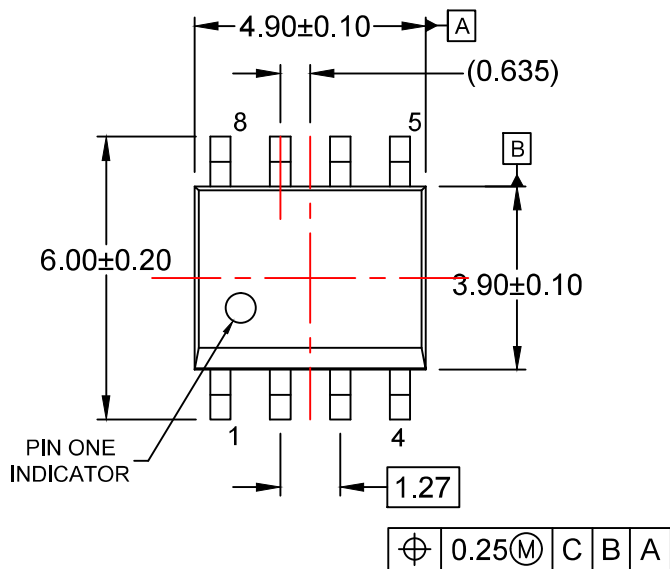

Figure 45. Zoom-In to Top Layer

Related Resources

[*FPF2300/02/03 Evaluation Board User Guide: Power Switch for USB Applications*](#)



NOTES:

- A) THIS PACKAGE CONFORMS TO JEDEC MS-012, VARIATION AA.
- B) ALL DIMENSIONS ARE IN MILLIMETERS.
- C) DIMENSIONS DO NOT INCLUDE MOLD FLASH OR BURRS.
- D) LANDPATTERN STANDARD: SOIC127P600X175-8M
- E) DRAWING FILENAME: M08Arev16



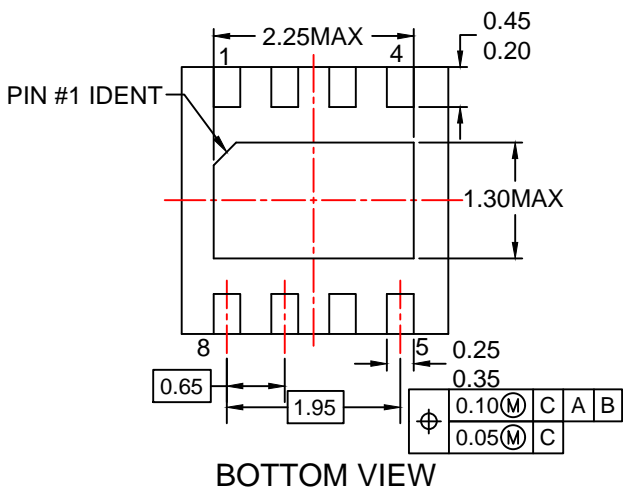
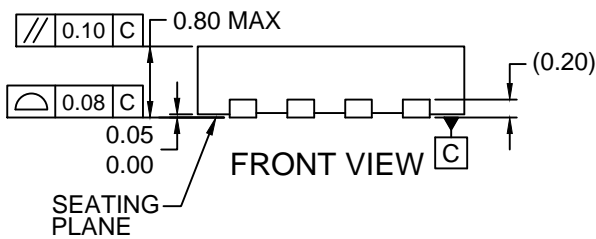
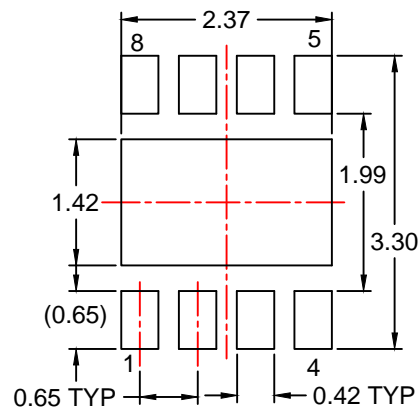
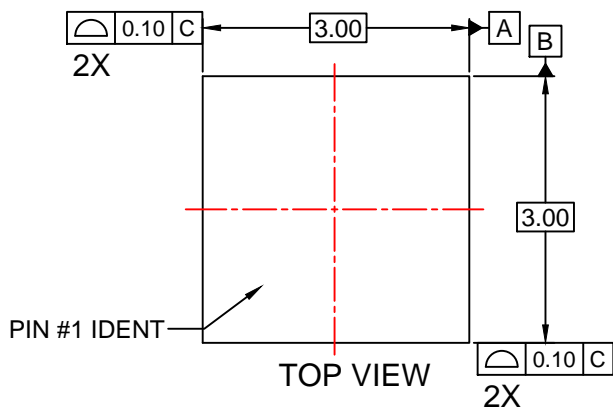

NOTES:

- A. CONFORMS TO JEDEC REGISTRATION MO-229, VARIATION VEEC, DATED 11/2001.
- B. DIMENSIONS ARE IN MILLIMETERS.
- C. DIMENSIONS AND TOLERANCES PER ASME Y14.5M, 2009.
- D. LAND PATTERN RECOMMENDATION IS EXISTING INDUSTRY LAND PATTERN.
- E. DRAWING FILENAME: MKT-MLP08Drev3



ON Semiconductor and  are trademarks of Semiconductor Components Industries, LLC dba ON Semiconductor or its subsidiaries in the United States and/or other countries. ON Semiconductor owns the rights to a number of patents, trademarks, copyrights, trade secrets, and other intellectual property. A listing of ON Semiconductor's product/patent coverage may be accessed at www.onsemi.com/site/pdf/Patent-Marking.pdf. ON Semiconductor reserves the right to make changes without further notice to any products herein. ON Semiconductor makes no warranty, representation or guarantee regarding the suitability of its products for any particular purpose, nor does ON Semiconductor assume any liability arising out of the application or use of any product or circuit, and specifically disclaims any and all liability, including without limitation special, consequential or incidental damages. Buyer is responsible for its products and applications using ON Semiconductor products, including compliance with all laws, regulations and safety requirements or standards, regardless of any support or applications information provided by ON Semiconductor. "Typical" parameters which may be provided in ON Semiconductor data sheets and/or specifications can and do vary in different applications and actual performance may vary over time. All operating parameters, including "Typicals" must be validated for each customer application by customer's technical experts. ON Semiconductor does not convey any license under its patent rights nor the rights of others. ON Semiconductor products are not designed, intended, or authorized for use as a critical component in life support systems or any FDA Class 3 medical devices or medical devices with a same or similar classification in a foreign jurisdiction or any devices intended for implantation in the human body. Should Buyer purchase or use ON Semiconductor products for any such unintended or unauthorized application, Buyer shall indemnify and hold ON Semiconductor and its officers, employees, subsidiaries, affiliates, and distributors harmless against all claims, costs, damages, and expenses, and reasonable attorney fees arising out of, directly or indirectly, any claim of personal injury or death associated with such unintended or unauthorized use, even if such claim alleges that ON Semiconductor was negligent regarding the design or manufacture of the part. ON Semiconductor is an Equal Opportunity/Affirmative Action Employer. This literature is subject to all applicable copyright laws and is not for resale in any manner.

PUBLICATION ORDERING INFORMATION

LITERATURE FULFILLMENT:

Literature Distribution Center for ON Semiconductor
19521 E. 32nd Pkwy, Aurora, Colorado 80011 USA
Phone: 303-675-2175 or 800-344-3860 Toll Free USA/Canada
Fax: 303-675-2176 or 800-344-3867 Toll Free USA/Canada
Email: orderlit@onsemi.com

N. American Technical Support: 800-282-9855 Toll Free
USA/Canada
Europe, Middle East and Africa Technical Support:
Phone: 421 33 790 2910
Japan Customer Focus Center
Phone: 81-3-5817-1050

ON Semiconductor Website: www.onsemi.com
Order Literature: <http://www.onsemi.com/orderlit>
For additional information, please contact your local
Sales Representative

OUR CERTIFICATE

DiGi provide top-quality products and perfect service for customer worldwide through standardization, technological innovation and continuous improvement. DiGi through third-party certification, we strictly control the quality of products and services. Welcome your RFQ to

Email: Info@DiGi-Electronics.com



Tel: +00 852-30501935

RFQ Email: Info@DiGi-Electronics.com

DiGi is a global authorized distributor of electronic components.