

FSL4110LRN Datasheet

www.digi-electronics.com



https://www.DiGi-Electronics.com

DiGi Electronics Part Number	FSL4110LRN-DG
Manufacturer	onsemi
Manufacturer Product Number	FSL4110LRN
Description	IC OFFLINE SWITCH FLYBACK 7DIP
Detailed Description	Converter Offline Flyback Topology 50kHz 7-DIP

This model FSL4110LRN is available at DiGi Electronics.

DiGi Electronics offers a global database of semiconductor and electronic component datasheets.

We welcome your inquiries regarding pricing, lead time, or other product-related questions.

 [Request a Quote](#)

 [Datasheet Search](#)



Tel: +00 852-30501935

RFQ Email: Info@DiGi-Electronics.com

DiGi is a global authorized distributor of electronic components.

Purchase and inquiry

Manufacturer Product Number:

FSL4110LRN

Series:

-

Output Isolation:

Isolated

Voltage - Breakdown:

1000V

Voltage - Start Up:

12 V

Duty Cycle:

67%

Power (Watts):

9 W

Control Features:

-

Package / Case:

8-DIP (0.300", 7.62mm), 7 Leads

Mounting Type:

Through Hole

Manufacturer:

onsemi

Product Status:

Active

Internal Switch(s):

Yes

Topology:

Flyback

Voltage - Supply (Vcc/Vdd):

8V ~ 27V

Frequency - Switching:

50kHz

Fault Protection:

Current Limiting, Over Load, Over Temperature, Over Voltage

Operating Temperature:

-40°C ~ 125°C (TJ)

Supplier Device Package:

7-DIP

Base Product Number:

FSL4110

Environmental & Export classification

RoHS Status:

ROHS3 Compliant

REACH Status:

REACH Unaffected

HTSUS:

8542.39.0001

Moisture Sensitivity Level (MSL):

Not Applicable

ECCN:

EAR99

1000 V SenseFET Integrated Power Switch

FSL4110LR

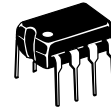

PDIP-7 (PDIP-8 LESS PIN 6)
(7-DIP)
CASE 626A

Description

The FSL4110LR is an integrated pulse width modulation (PWM) controller and 1000 V avalanche rugged SenseFET specifically designed for high input voltage offline Switching Mode Power Supplies (SMPS) with minimal external components. V_{CC} can be supplied through integrated high-voltage power regulator without auxiliary bias winding.

The integrated PWM controller includes a fixed-frequency oscillator, Under-Voltage Lockout (UVLO), Leading-Edge Blanking (LEB), optimized gate driver, soft-start, temperature-compensated precise current sources for loop-compensation, and variable protection circuitry.

Compared with a discrete MOSFET and PWM controller solution, the FSL4110LR reduces total cost, component count, PCB size, and weight; while simultaneously increasing efficiency, productivity, and system reliability. This device provides a basic platform for cost-effective design of a flyback converter.

Features

- Built-in Avalanche Rugged 1000 V SenseFET
- Precise Fixed Operating Frequency: 50 kHz
- V_{CC} can be Supplied from either Bias-winding or Self-biasing
- Soft Burst-Mode Operation Minimizing Audible Noise
- Random Frequency Fluctuation for Low EMI
- Pulse-by-Pulse Current Limit
- Various Protection Functions: Overload Protection (OLP), Over-Voltage Protection (OVP), Abnormal Over-Current Protection (AOCP), Internal Thermal Shutdown (TSD) with Hysteresis, Under-Voltage Lockout (UVLO) and Line Over-Voltage Protection (LOVP) with Hysteresis.
- Built-in Internal Startup and Soft-Start Circuit
- Fixed 1.6 s Restart Time for Safe Auto-Restart Mode of All Protections
- These are Pb-Free Devices

Applications

- SMPS for Electric Metering
- Auxiliary Power Supply for 3-Phase Input Industrial Systems

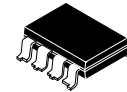

PDIP7 MINUS PIN 6 GW
(7-LSOP)
CASE 707AA

MARKING DIAGRAM

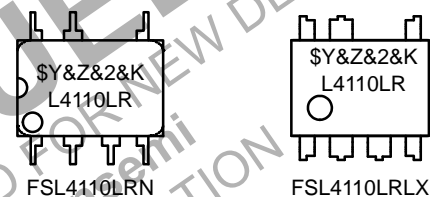

\$Y	= Logo
&Z	= Assembly Plant Code
&2	= 2-Digit Date Code
&K	= 2-Digits Lot Run Traceability Code
L4110LR	= Specific Device Code

ORDERING INFORMATION

See detailed ordering and shipping information on page 13 of this data sheet.

FSL4110LR

TYPICAL APPLICATION CIRCUIT

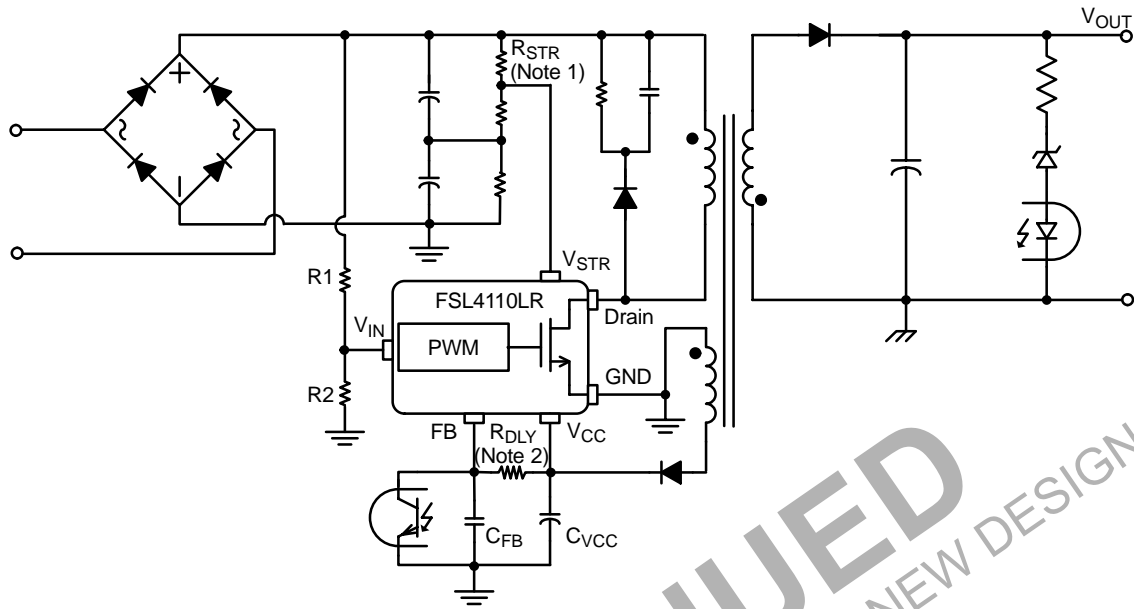

NOTES:

1. R_{STR} : See the functional description [Startup and High-Voltage Regulator](#).
2. R_{DLY} : See the functional description [Overload Protection \(OLP\)](#).

Figure 1. Typical Application Circuit

INTERNAL BLOCK DIAGRAM

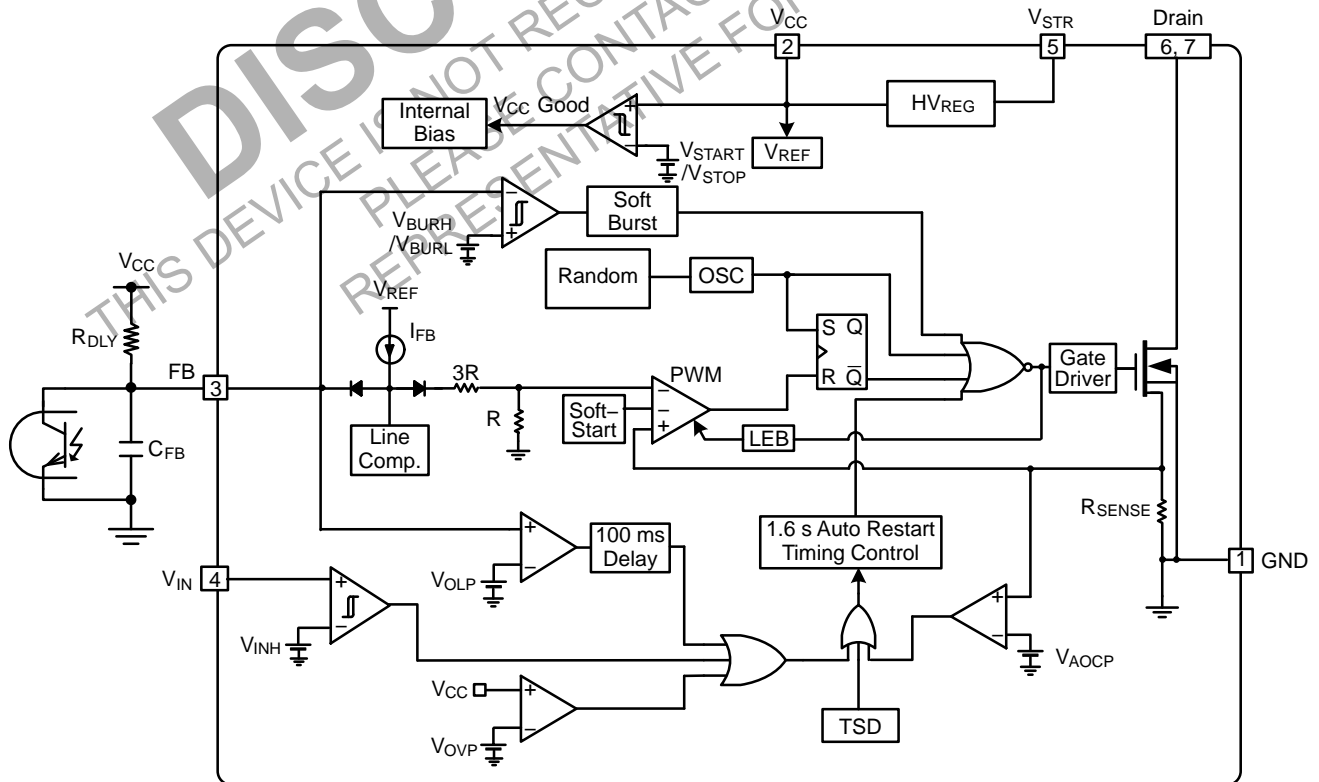
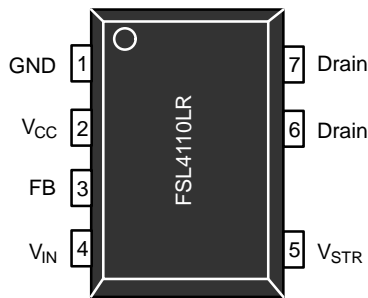

Figure 2. Internal Block Diagram

FSL4110LR**PIN CONFIGURATION****Figure 3. Pin Configuration (Top View)****PIN DEFINITIONS**

Pin #	Name	Description
1	GND	Ground. The SenseFET source terminal on primary side and the internal PWM control ground.
2	V _{CC}	Power Supply Voltage Input. This pin is the positive supply input, which provides the internal operating current for startup and steady-state operation. This voltage is supplied from internal high-voltage regulator via pin 5 (V _{STR}) during startup (see Figure 2). When the external bias voltage is higher than 10 V, internal high voltage regulator is disable. A ceramic capacitor need to be placed as close as possible between this pin and pin 1 (GND). Recommended distance is less than 3 mm.
3	FB	Feedback. This pin is internally connected to the inverting input to the PWM comparator. This pin has a 100 μ A current source internally. The collector of an opto-coupler is typically tied to this pin. A capacitor should be placed between this pin and GND. A resistor should be connected between this pin and pin 2 (V _{CC}) to generate delay current (I _{DELAY}) for overload protection delay time. The resistance should not be exceed 5 M Ω in self-biasing.
4	V _{IN}	Line Over-Voltage Input. This pin is the input of divided line voltage. The voltage is divided by resistors. When this voltage is higher than 2 V, the FSL4110LR is not operationed. If this pin is not used, it should be connected to the ground.
5	V _{STR}	Startup. Connected to the rectified AC line voltage source. At startup, the internal switch supplies internal bias and charges an external storage capacitor placed between V _{CC} pin and ground. Once V _{CC} reaches 12 V, all internal blocks are activated. The internal high-voltage regulator turns on and off to maintain V _{CC} at 10 V without auxiliary bias winding.
6, 7	Drain	Drain. Designed to connect directly to the primary lead of the transformer and capable of switching a maximum of 1000 V. Minimizing the length of the trace connecting these pins to the transformer decreases leakage inductance.

FSL4110LR

ABSOLUTE MAXIMUM RATINGS

Symbol	Parameter	Min	Max	Unit	
V_{STR}	V_{STR} Pin Voltage	–	700	V	
V_{DS}	Drain Pin Voltage	–	1000	V	
V_{CC}	V_{CC} Pin Voltage	–	27	V	
V_{FB}	Feedback Pin Voltage (Note 3)	–0.3	12.0	V	
V_{IN}	V_{IN} Pin Voltage (Note 3)	–0.3	12.0	V	
I_{DM}	Drain Current Pulsed	–	4	A	
I_{DS}	Continuous Switching Drain Current (Note 4)	$T_C = 25^\circ\text{C}$	–	1	A
		$T_C = 100^\circ\text{C}$	–	0.6	A
E_{AS}	Single Pulsed Avalanche Energy (Note 5)	–	51	mJ	
P_D	Total Power Dissipation ($T_C = 25^\circ\text{C}$) (Note 6)	–	1.5	W	
T_J	Maximum Junction Temperature	–	150	$^\circ\text{C}$	
	Operating Junction Temperature (Note 7)	–40	+125	$^\circ\text{C}$	
TSTG	Storage Temperature	–55	+150	$^\circ\text{C}$	

Stresses exceeding those listed in the Maximum Ratings table may damage the device. If any of these limits are exceeded, device functionality should not be assumed, damage may occur and reliability may be affected.

- V_{FB} and V_{IN} are clamped by internal clamping diode (11 V, $I_{CLAMP_MAX} < 100 \mu\text{A}$).
- Repetitive peak switching current when the inductive load is assumed: Limited by maximum duty ($D_{MAX} = 0.73$) and junction temperature (see Figure 4).
- $I_{AS} = 3.2 \text{ A}$, $L = 10 \text{ mH}$, starting $T_J = 25^\circ\text{C}$.
- Infinite cooling condition (refer to the SEMI G30–88).
- Although this parameter guarantees IC operation, it does not guarantee all electrical characteristics.

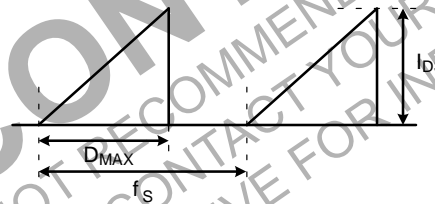

Figure 4. Repetitive Peak Switching Current

THERMAL IMPEDANCE

Symbol	Parameter	Value	Unit
θ_{JA}	Junction-to-Ambient Thermal Impedance (Note 8)	85	$^\circ\text{C/W}$

- JEDEC recommended environment, JESD51–2, and test board, JESD51–3, with minimum land pattern.

ESD CAPABILITY

Symbol	Parameter	Value	Unit
ESD	Human Body Model, ANSI/ESDA/JEDEC JS–001–2012	5.0	KV
	Charged Device Model, JESD22–C101	2.0	

FSL4110LR

ELECTRICAL CHARACTERISTICS ($T_J = -40^{\circ}\text{C}$ to 125°C unless otherwise noted)

Symbol	Parameter	Conditions	Min	Typ	Max	Unit	
SenseFET SECTION							
BV_{DSS}	Drain–Source Breakdown Voltage (Note 9)	$V_{GS} = 0\text{ V}$, $I_D = 250\ \mu\text{A}$	1000	–	–	V	
I_{DSS}	Zero–Gate–Voltage Drain Current (Note 9)	$V_{DS} = 1000\text{ V}$, $V_{GS} = 0\text{ V}$	–	–	250	μA	
$R_{DS(ON)}$	Drain–Source On–State Resistance (Note 9)	$V_{GS} = 10\text{ V}$, $I_D = 1.0\text{ A}$	–	–	10	Ω	
C_{ISS}	Input Capacitance (Note 9) (Note 10)	$V_{DS} = 25\text{ V}$, $V_{GS} = 0\text{ V}$, $f = 1\text{ MHz}$	–	367	477	pF	
C_{OSS}	Output Capacitance (Note 9) (Note 10)		–	37.5	48.8	pF	
$t_{d(on)}$	Turn–On Delay Time (Note 9)		$V_{DD} = 500\text{ V}$, $I_D = 1.0\text{ A}$, $V_{GS} = 10\text{ V}$, $R_g = 25\ \Omega$	–	13.7	–	ns
t_r	Rise Time (Note 9)			–	14	–	ns
$t_{d(off)}$	Turn–Off Delay Time (Note 9)			–	33	–	ns
t_f	Fall Time (Note 9)			–	45	–	ns
CONTROL SECTION							
f_S	Switching Frequency (Note 9)	$V_{CC} = 14\text{ V}$, $V_{FB} = 4\text{ V}$	46.5	50.0	53.5	kHz	
f_M	Frequency Modulation (Note 10)		–	± 1.5	–	kHz	
D_{MAX}	Maximum Duty Ratio	$V_{CC} = 14\text{ V}$, $V_{FB} = 4\text{ V}$	61	67	73	%	
I_{FB}	Feedback Source Current (Note 9)	$V_{FB} = 0\text{ V}$	70	100	130	μA	
V_{START}	UVLO Threshold Voltage	$V_{FB} = 0\text{ V}$, V_{CC} Sweep	11	12	13	V	
V_{STOP}		After Turn–on, $V_{FB} = 0\text{ V}$	7	8	9		
$t_{S/S}$	Internal Soft–Start Time	$V_{STR} = 40\text{ V}$, V_{CC} Sweep	–	20	–	ms	
BURST–MODE SECTION							
V_{BURH}	Burst–Mode Voltage (Note 9)	$V_{CC} = 14\text{ V}$, V_{FB} Sweep	0.45	0.50	0.55	V	
V_{BURL}			0.35	0.40	0.45	V	
V_{HYS}			–	100	–	mV	
PROTECTION SECTION							
I_{LIM}	Peak Drain Current Limit (Note 9)	$di/dt = 240\text{ mA}/\mu\text{s}$	0.45	0.52	0.59	A	
V_{OLP}	Overload Protection (Note 9)	$V_{CC} = 14\text{ V}$, V_{FB} Sweep	4.0	4.4	4.8	V	
V_{AOCP}	Abnormal Over–Current Protection (Note 10)		–	1.0	–	V	
t_{LEB}	Leading–Edge Blanking Time (Note 10) (Note 11)		–	250	–	ns	
t_{CLD}	Current Limit Delay Time (Note 10)		–	–	200	ns	
V_{OVP}	Over–Voltage Protection	V_{CC} Sweep	23.0	24.5	26.0	V	
V_{INH}	Line Over–Voltage Protection Threshold Voltage	$V_{CC} = 14\text{ V}$, V_{IN} Sweep	1.9	2.0	2.1	V	
V_{INHYS}	Line Over–Voltage Protection Hysteresis (Note 9)	$V_{CC} = 14\text{ V}$, V_{IN} Sweep	–	100	–	mV	
t_{DELAY}	Overload Protection Delay		–	100	–	ms	
$t_{RESTART}$	Restart Time After Protection (Note 10)		–	1.6	–	s	
TSD	Thermal Shutdown Temperature (Note 10)	Shutdown Temperature	130	140	150	$^{\circ}\text{C}$	
T_{HYS}		Hysteresis (FSL4110LRN)	–	60	–		
T_{HYS}		Hysteresis (FSL4110LRLX)	–	30	–		
HIGH VOLTAGE REGULATOR SECTION							
V_{HVREG}	HV Regulator Voltage	$V_{FB} = 0\text{ V}$, $V_{STR} = 40\text{ V}$	9	10	11	V	

FSL4110LR**ELECTRICAL CHARACTERISTICS** ($T_J = -40^{\circ}\text{C}$ to 125°C unless otherwise noted) (continued)

Symbol	Parameter	Conditions	Min	Typ	Max	Unit
TOTAL DEVICE SECTION						
I_{OP}	Operating Supply Current, (Control Part in Burst Mode) (Note 9)	$V_{CC} = 14\text{ V}$, $V_{FB} = 0\text{ V}$	–	0.40	0.50	mA
I_{OPS}	Operating Switching Current, (Control Part and SenseFET Part) (Note 9)	$V_{CC} = 14\text{ V}$, $V_{FB} = 2\text{ V}$	–	1.00	1.35	mA
I_{START}	Start Current (Note 9)	$V_{CC} = 11\text{ V}$ (Before V_{CC} Reaches V_{START})	–	160	240	μA
I_{CH}	Startup Charging Current (Note 9)	$V_{CC} = V_{FB} = 0\text{ V}$, $V_{STR} = 40\text{ V}$	1.5	2.0	–	mA
V_{STR}	Minimum V_{STR} Supply Voltage	$C_{VCC} = 0.1\ \mu\text{F}$, V_{STR} Sweep	–	–	26	V

Product parametric performance is indicated in the Electrical Characteristics for the listed test conditions, unless otherwise noted. Product performance may not be indicated by the Electrical Characteristics if operated under different conditions.

9. $T_J = 25^{\circ}\text{C}$.

10. Although these parameters are guaranteed, they are not 100% tested in production.

11. t_{LEB} includes gate turn-on time.

DISCONTINUED
 THIS DEVICE IS NOT RECOMMENDED FOR NEW DESIGN
 PLEASE CONTACT YOUR onsemi
 REPRESENTATIVE FOR INFORMATION

FSL4110LR

TYPICAL PERFORMANCE CHARACTERISTICS

(Characteristic graphs are normalized at $T_A = 25^\circ\text{C}$.)

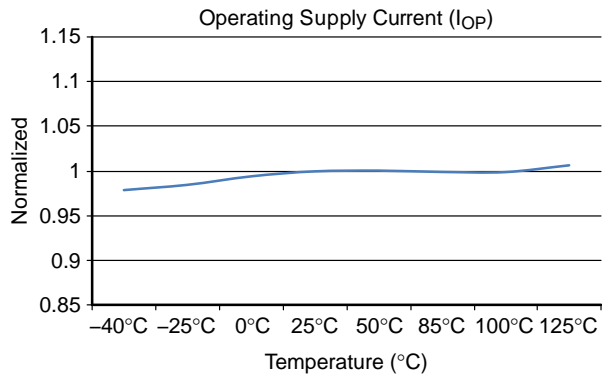

Figure 5. Operating Supply Current (I_{OP}) vs. T_A

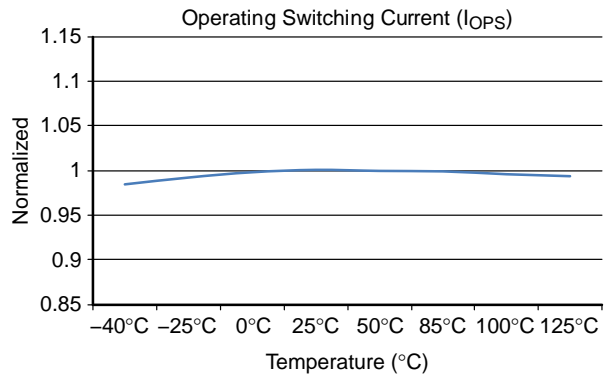

Figure 6. Operating Switching Current (I_{OPS}) vs. T_A

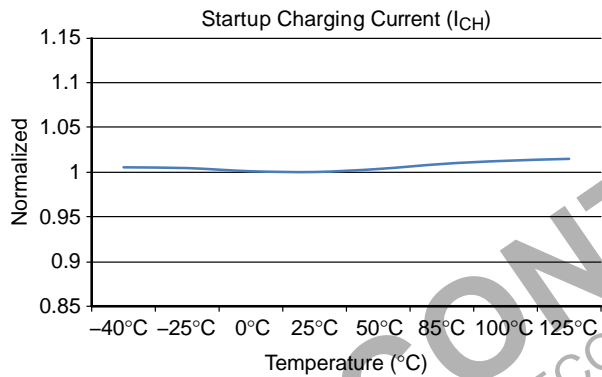

Figure 7. Startup Charging Current (I_{CH}) vs. T_A

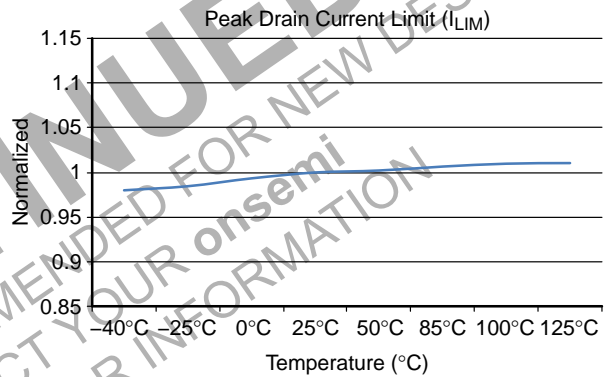

Figure 8. Peak Drain Current Limit (I_{LIM}) vs. T_A

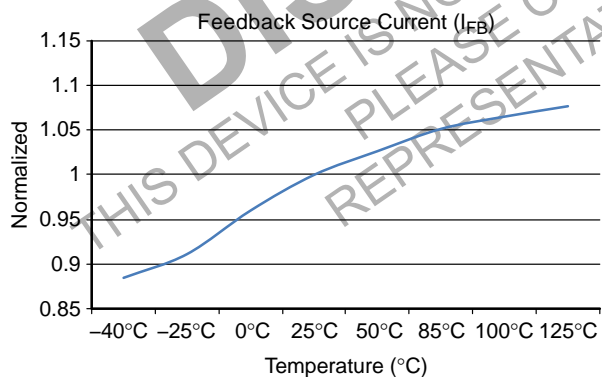

Figure 9. Feedback Source Current (I_{FB}) vs. T_A

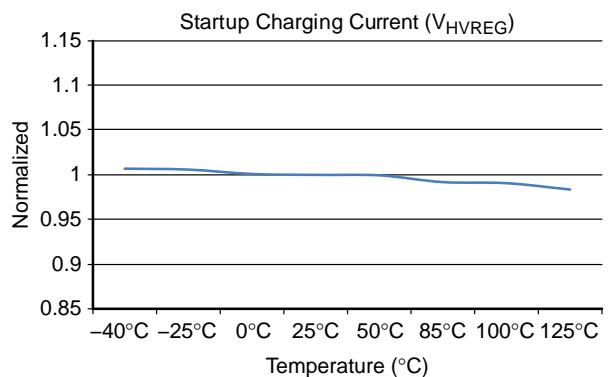

Figure 10. HV Regulator Voltage (V_{HVREG}) vs. T_A

FSL4110LR

TYPICAL PERFORMANCE CHARACTERISTICS (Continued)

(Characteristic graphs are normalized at $T_A = 25^\circ\text{C}$.)

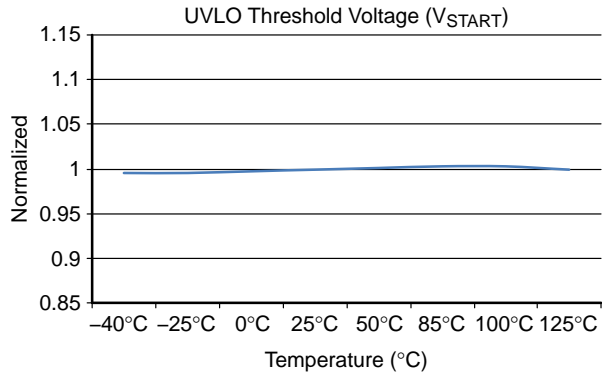

Figure 11. UVLO Threshold Voltage (V_{START}) vs. T_A

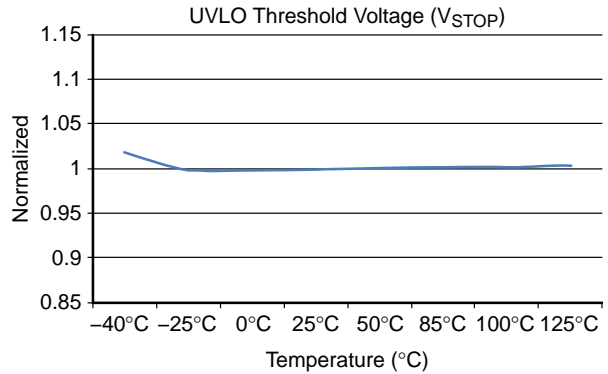

Figure 12. UVLO Threshold Voltage (V_{STOP}) vs. T_A

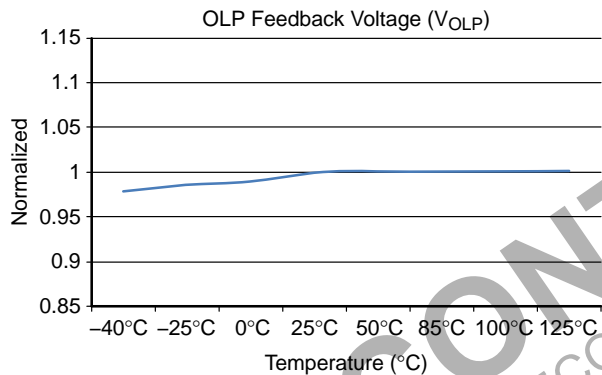

Figure 13. OLP Feedback Voltage (V_{OLP}) vs. T_A

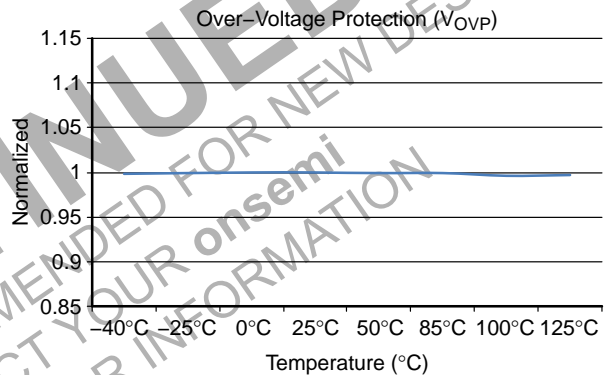

Figure 14. Over-Voltage Protection (V_{OVP}) vs. T_A

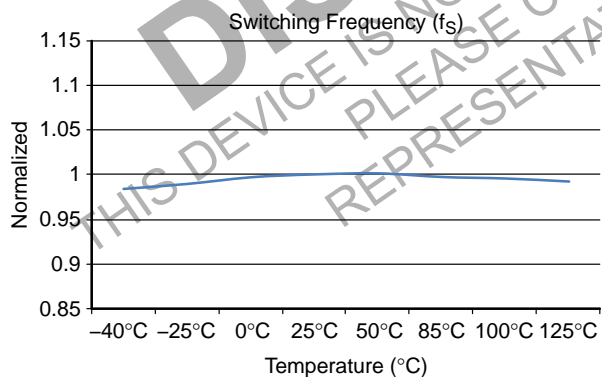

Figure 15. Switching Frequency (f_s) vs. T_A

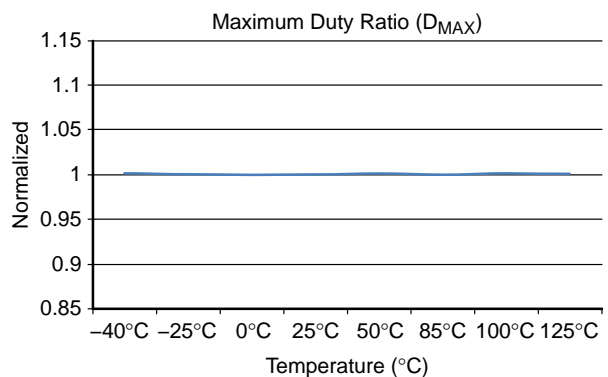

Figure 16. Maximum Duty Ratio (D_{MAX}) vs. T_A

FSL4110LR

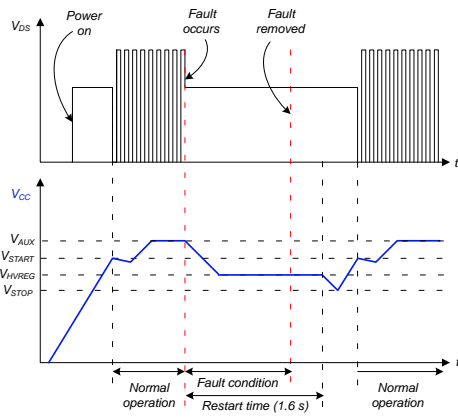

Figure 19. Auto-Restart Protection Waveforms

Overload Protection (OLP)

Overload is defined as the load current exceeding its normal level due to an unexpected abnormal event. In this situation, the protection circuit should trigger to protect the SMPS. However, even when the SMPS is in normal operation, the overload protection circuit can be triggered during load transition. To avoid this undesired operation, the overload protection circuit is designed to trigger only after a specified time to determine whether it is a transient situation or a true overload situation. Because of the pulse-by-pulse current-limit capability, the maximum peak current through the SenseFET is limited. If the output consumes more than this maximum power, the output voltage decreases below the set voltage. This reduces the current through the opto-diode, which also reduces the opto-coupler transistor current, thus increasing the feedback voltage (V_{FB}). If V_{FB} exceeds 2.4 V, internal diode D1 is blocked and the current (I_{DLY}) by R_{DLY} starts to charge C_{FB} . If feedback voltage reaches 4.4 V, internal fixed delay time (t_{DELAY}) starts counting. If feedback voltage maintains over 4.4 V after t_{DELAY} (100 ms) the switching operation is terminated (see Figure 20). The internal OLP circuit is shown in Figure 21.

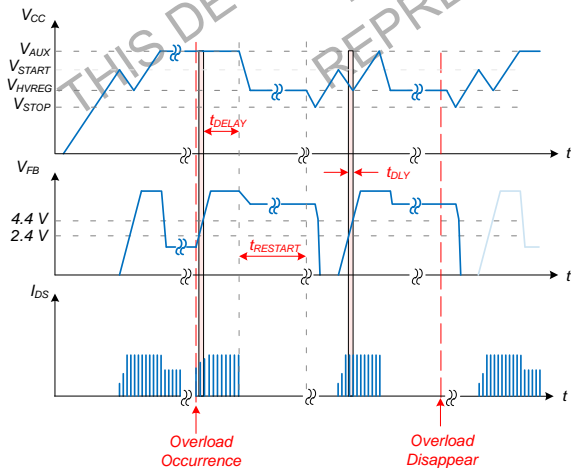

Figure 20. OLP Waveforms

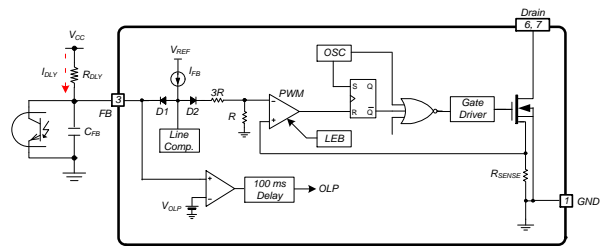

Figure 21. OLP Circuit

Recommended the R_{DLY} value is less than 5 MΩ in self-biasing. The delay time (t_{DLY}) can be calculated by equation (3).

$$t_{DLY} = -R_{DLY} \times C_{FB} \times \ln\left(1 - \frac{2}{V_{CC} - 2.4}\right) \quad (\text{eq. 3})$$

Example:

When, $R_{DLY} = 3 \text{ M}\Omega$, $C_{FB} = 68 \text{ nF}$, $V_{CC} = 15 \text{ V}$,

$t_{DLY} = 35 \text{ ms}$

∴ Total delay time for OLP: 135 ms

Abnormal Over-Current Protection (AOCP)

When the secondary rectifier diodes or the transformer pins are shorted, a steep current with extremely high di/dt can flow through the SenseFET during the minimum turn-on time. Overload protection is not enough to protect the FSL4110LR in that abnormal case (see Figure 22); since severe current stress is imposed on the SenseFET until OLP is triggered. The internal AOCP circuit is shown in Figure 23. When the gate turn-on signal is applied to the power SenseFET, the AOCP block is enabled and monitors the current through the sensing-resistor. The voltage across the resistor is compared with a preset AOCP level. If the sensing resistor voltage is greater than the AOCP level, the high signal is applied to input of the NOR gate, resulting in the shutdown of the SMPS.

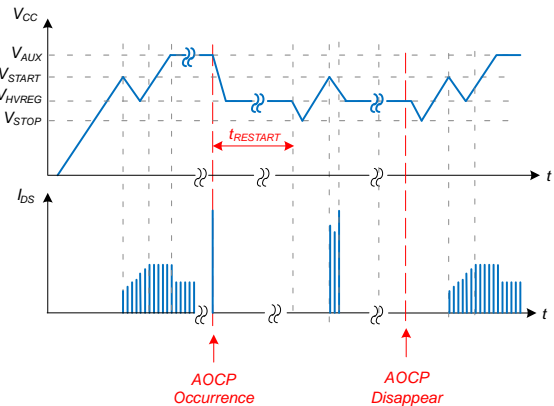

Figure 22. AOCP Waveforms

FSL4110LR

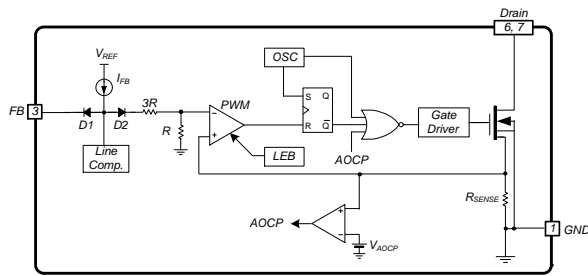

Figure 23. AOCPS Circuit

Over-Voltage Protection (OVP)

If the secondary-side feedback circuit malfunctions or a solder defect causes an opening in the feedback path, the current through the opto-coupler transistor becomes almost zero. Then V_{FB} climbs in a similar manner to the overload situation, forcing the preset maximum drain current to flow until the overload protection is triggered. Because more energy than required is provided to the output, the output voltage may exceed the rated voltage before the overload protection is triggered, resulting in the breakdown of the devices in the secondary side. To prevent this situation, an OVP circuit is employed. In general, the V_{CC} is proportional to the output voltage when the bias-winding is used and the FSL4110LR uses V_{CC} instead of directly monitoring the output voltage. If V_{CC} exceeds 24.5 V, an OVP circuit is triggered, resulting in the termination of the switching operation. To avoid undesired activation of OVP during normal operation, V_{CC} should be designed to be below 24.5 V in the normal conditions. The internal OVP circuit is shown in Figure 24.

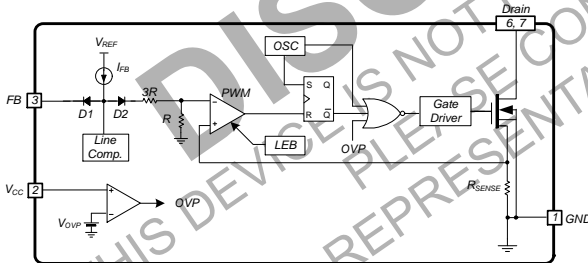

Figure 24. OVP Circuit

Thermal Shutdown (TSD)

The SenseFET and control IC integrated on the same package makes it easier to detect the temperature of the SenseFET. When the junction temperature exceeds 140°C, thermal shutdown is activated. The FSL4110LR is restarted when the temperature decreases by 60°C within $t_{RESTART}$ (1.6 s).

Line Over-Voltage Protection (LOVP)

If the line input voltage is increased to an undesirable level, high line input voltage creates high-voltage stress on the entire system. To protect the SMPS from this abnormal condition, LOVP is included. It is comprised of detecting V_{IN} voltage by using divided resistors. When voltage of V_{IN} voltage is higher than 2.0 V, this condition is recognized as an

abnormal error and PWM switching shuts down until voltage of V_{IN} voltage decreases to around 1.9 V within $t_{RESTART}$ (see Figure 25). The internal LOVP circuit is shown in Figure 26.

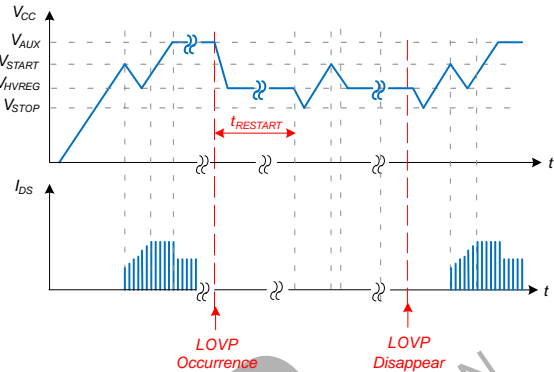

Figure 25. LOVP Waveforms

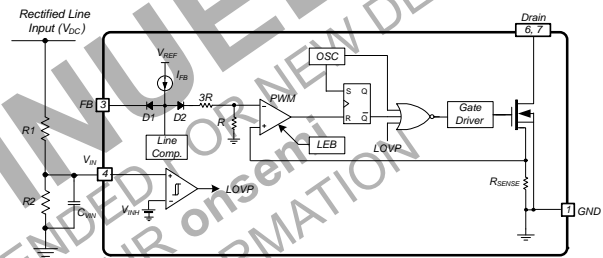

Figure 26. LOVP Circuit

Equation (4) calculates the level of input over-voltage to RMS value.

$$R2 = \frac{V_{INH} \times R1}{V_{DC} - V_{INH}} \quad (\text{eq. 4})$$

The resistance of divided resistor can be adjusted as necessary. Small resistance can bring relatively large stand-by power consumption at light-load condition. To avoid this situation, a several MΩ resistor is recommended. For stable operation, a several MΩ resistor should accompany a capacitor (C_{VIN}) with hundreds of pF capacitance between the V_{IN} pin and GND.

Oscillator Block

The oscillator frequency is set internally and the FSL4110LR has a random frequency fluctuation function as shown in Figure 27. Fluctuation of the switching frequency can reduce EMI by spreading the energy over a wider frequency range than the bandwidth measured by the EMI test equipment. The range of frequency variation is fixed internally; however, its selection is randomly chosen by the combination of an external feedback voltage and an internal free-running oscillator. This randomly chosen switching frequency effectively spreads the EMI noise near switching frequency and allows the use of a cost-effective inductor instead of an AC input line filter to satisfy world-wide EMI requirements.

FSL4110LR

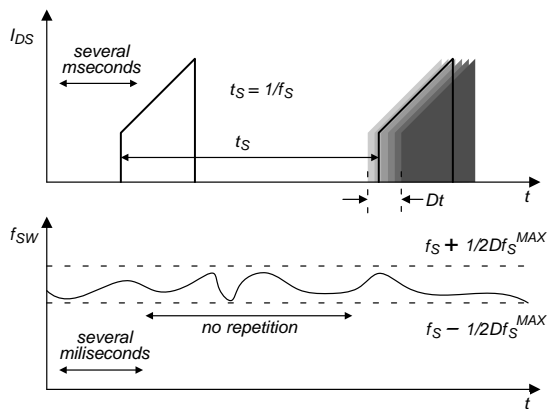

Figure 27. Frequency Fluctuation Waveforms

Soft-Start

The internal soft-start circuit slowly increases the SenseFET current after it starts. The typical soft-start time is 20 ms, as shown in Figure 28, where progressive increments of the SenseFET current are allowed during startup. The pulse width to the power switching device is progressively increased to establish the correct working conditions for transformers, inductors, and capacitors. The voltage on the output capacitors is gradually increased to smoothly establish the required output voltage. Soft-start also helps to prevent transformer saturation and reduces stress on the secondary diode.

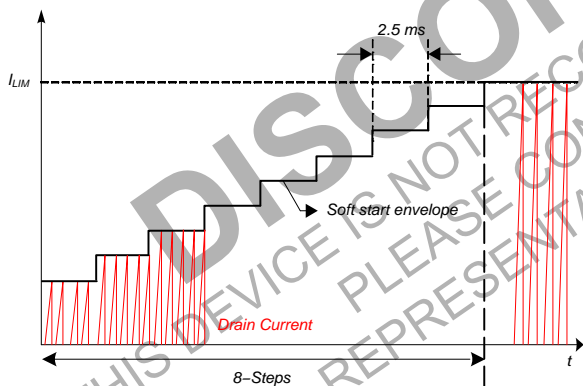

Figure 28. Internal Soft-Start

Burst Mode Operation

To minimize power dissipation in standby mode, the FSL4110LR enters burst mode. As the load decreases, the feedback voltage decreases. The device automatically enters burst mode when the feedback voltage drops below V_{BURL} (400 mV), as shown in Figure 29. At this point, switching stops and the output voltages start to drop at a rate dependent on standby current load. This causes the feedback voltage to rise. Once it passes V_{BURH} (500 mV), switching resumes. Feedback voltage then falls and the process repeats. Burst Mode alternately enables and disables switching of the SenseFET, reducing switching loss in standby mode.

Additionally to reduce the audible noise soft-burst is implemented.

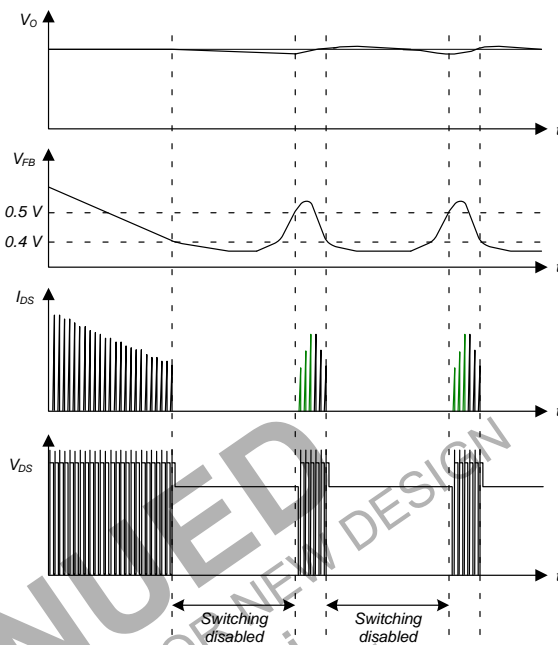

Figure 29. Burst Mode Operation

Line Compensation

All of switching devices have their own inherent propagation delays. This propagation delay will cause a current limit delay defined as t_{CLD} . Because there is a current limit delay, t_{CLD} , there is a difference in the current peak between low and high input voltage. The variance in the current peak is related to the difference between the input voltages, a wider gap in input voltage will result in a greater variance of the current peak.

In order to have a constant current peak regardless of the input voltage, line compensation is required. FSL4110LR has line compensation, so the real peak value of high input voltage is similar to that of low input voltage. t_{CLD} effect could be neglected as showed Figure 30.

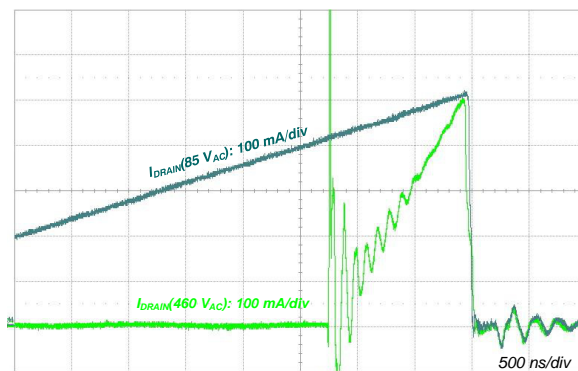

Figure 30. I_{LIMIT} Waveforms (85 V_{AC} vs. 460 V_{AC})

FSL4110LR**ORDERING INFORMATION**

Part Number	Package	Operating Junction Temperature	Current Limit	R _{DS(ON)} (Max)	Output Power Table (Note 12)		Shipping†
					45~460 V _{AC} (Note 13)	85~460 V _{AC} (Note 13)	
FSL4110LRN	PDIP-7 (PDIP-8 LESS PIN 6) (7-DIP) (Pb-Free)	-40°C~125°C	0.52 A	10 Ω	4 W (Note 14)	9 W (Note 14)	3000 Units / Tube
FSL4110LRLX	PDIP7 MINUS PIN 6 GW (7-LSOP) (Pb-Free)						1000 / Tape & Reel

†For information on tape and reel specifications, including part orientation and tape sizes, please refer to our Tape and Reel Packaging Specifications Brochure, BRD8011/D.

12. The junction temperature can limit the maximum output power.

13. Maximum practical continuous power in an open-frame design at 50°C ambient temperatures.

14. Bias winding condition.

DISCONTINUED
 THIS DEVICE IS NOT RECOMMENDED FOR NEW DESIGN
 PLEASE CONTACT YOUR onsemi
 REPRESENTATIVE FOR INFORMATION



**MECHANICAL CASE OUTLINE
PACKAGE DIMENSIONS**



PDIP-7 (PDIP-8 LESS PIN 6)
CASE 626A
ISSUE C

DATE 22 APR 2015

SCALE 1:1

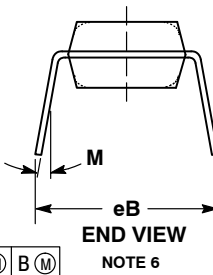
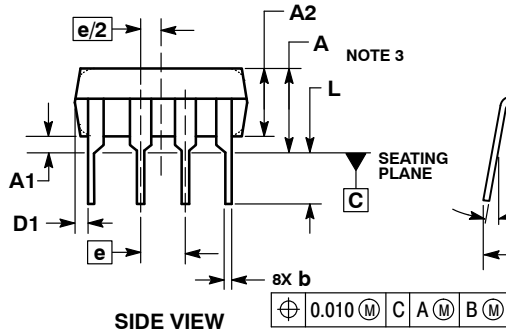
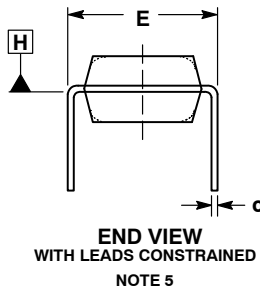
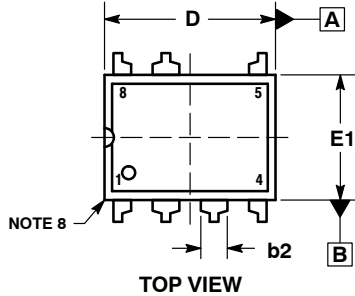

NOTES:

1. DIMENSIONING AND TOLERANCING PER ASME Y14.5M, 1994.
2. CONTROLLING DIMENSION: INCHES.
3. DIMENSIONS A, A1 AND L ARE MEASURED WITH THE PACKAGE SEATED IN JEDEC SEATING PLANE GAUGE GS-3.
4. DIMENSIONS D, D1 AND E1 DO NOT INCLUDE MOLD FLASH OR PROTRUSIONS. MOLD FLASH OR PROTRUSIONS ARE NOT TO EXCEED 0.10 INCH.
5. DIMENSION E IS MEASURED AT A POINT 0.015 BELOW DATUM PLANE H WITH THE LEADS CONSTRAINED PERPENDICULAR TO DATUM C.
6. DIMENSION eB IS MEASURED AT THE LEAD TIPS WITH THE LEADS UNCONSTRAINED.
7. DATUM PLANE H IS COINCIDENT WITH THE BOTTOM OF THE LEADS, WHERE THE LEADS EXIT THE BODY.
8. PACKAGE CONTOUR IS OPTIONAL (ROUNDED OR SQUARE CORNERS).

DIM	INCHES		MILLIMETERS	
	MIN	MAX	MIN	MAX
A	----	0.210	----	5.33
A1	0.015	----	0.38	----
A2	0.115	0.195	2.92	4.95
b	0.014	0.022	0.35	0.56
b2	0.060 TYP		1.52 TYP	
C	0.008	0.014	0.20	0.36
D	0.355	0.400	9.02	10.16
D1	0.005	----	0.13	----
E	0.300	0.325	7.62	8.26
E1	0.240	0.280	6.10	7.11
e	0.100 BSC		2.54 BSC	
eB	----	0.430	----	10.92
L	0.115	0.150	2.92	3.81
M	----	10°	----	10°

GENERIC MARKING DIAGRAM*

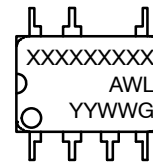

- XXXX = Specific Device Code
- A = Assembly Location
- WL = Wafer Lot
- YY = Year
- WW = Work Week
- G = Pb-Free Package

*This information is generic. Please refer to device data sheet for actual part marking. Pb-Free indicator, "G" or microdot "•", may or may not be present. Some products may not follow the Generic Marking.

DOCUMENT NUMBER:	98AON11774D	Electronic versions are uncontrolled except when accessed directly from the Document Repository. Printed versions are uncontrolled except when stamped "CONTROLLED COPY" in red.
DESCRIPTION:	PDIP-7 (PDIP-8 LESS PIN 6)	PAGE 1 OF 1

onsemi and ONSEMI are trademarks of Semiconductor Components Industries, LLC dba onsemi or its subsidiaries in the United States and/or other countries. onsemi reserves the right to make changes without further notice to any products herein. onsemi makes no warranty, representation or guarantee regarding the suitability of its products for any particular purpose, nor does onsemi assume any liability arising out of the application or use of any product or circuit, and specifically disclaims any and all liability, including without limitation special, consequential or incidental damages. onsemi does not convey any license under its patent rights nor the rights of others.

PDIP7 MINUS PIN 6 GW
CASE 707AA
ISSUE O

DATE 31 JAN 2017

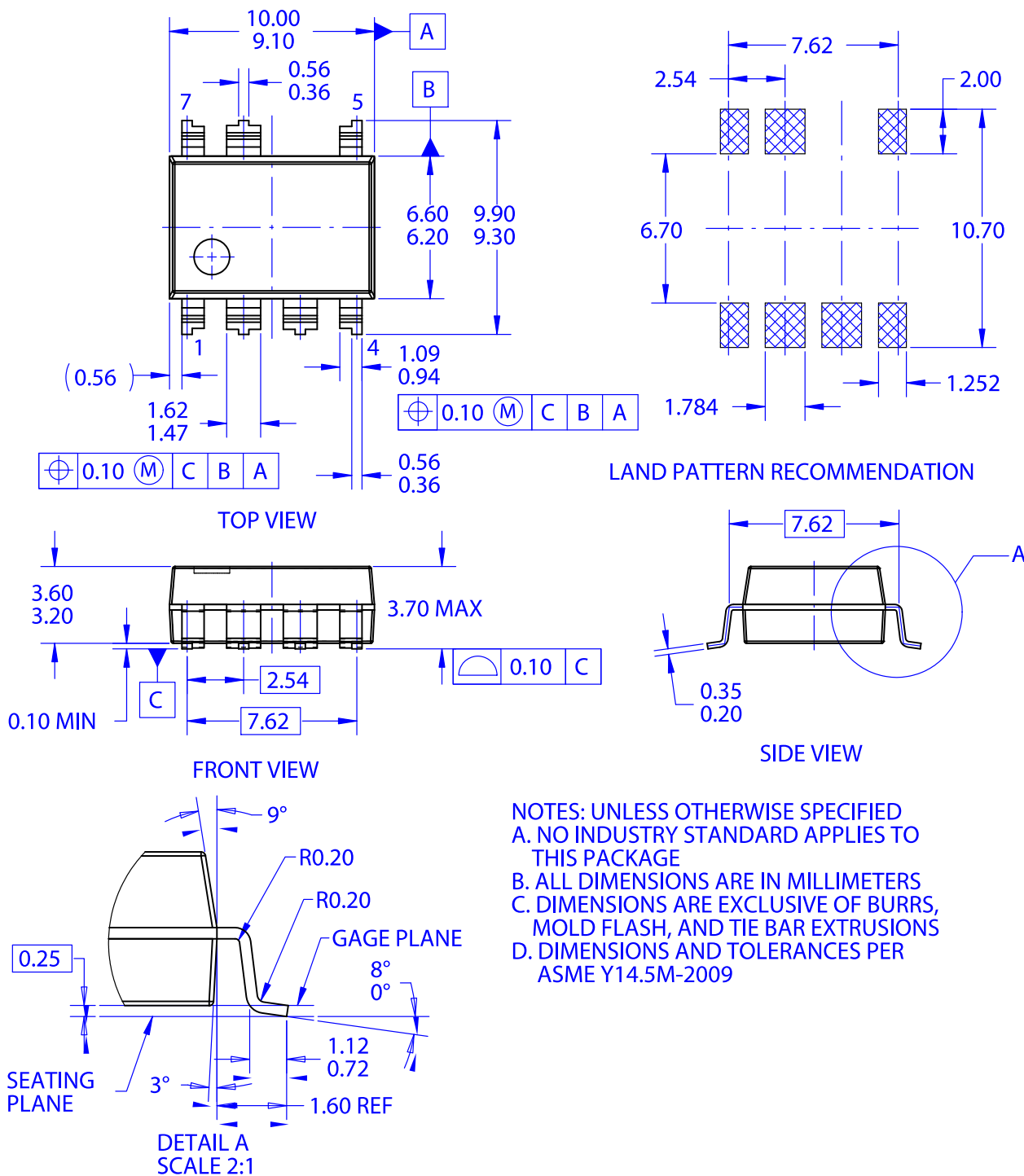

NOTES: UNLESS OTHERWISE SPECIFIED
 A. NO INDUSTRY STANDARD APPLIES TO THIS PACKAGE
 B. ALL DIMENSIONS ARE IN MILLIMETERS
 C. DIMENSIONS ARE EXCLUSIVE OF BURRS, MOLD FLASH, AND TIE BAR EXTRUSIONS
 D. DIMENSIONS AND TOLERANCES PER ASME Y14.5M-2009

DOCUMENT NUMBER:	98AON13755G	Electronic versions are uncontrolled except when accessed directly from the Document Repository. Printed versions are uncontrolled except when stamped "CONTROLLED COPY" in red.
DESCRIPTION:	PDIP7 MINUS PIN 6 GW	PAGE 1 OF 1

onsemi and ONSEMI are trademarks of Semiconductor Components Industries, LLC dba onsemi or its subsidiaries in the United States and/or other countries. onsemi reserves the right to make changes without further notice to any products herein. onsemi makes no warranty, representation or guarantee regarding the suitability of its products for any particular purpose, nor does onsemi assume any liability arising out of the application or use of any product or circuit, and specifically disclaims any and all liability, including without limitation special, consequential or incidental damages. onsemi does not convey any license under its patent rights nor the rights of others.

onsemi, **Onsemi**, and other names, marks, and brands are registered and/or common law trademarks of Semiconductor Components Industries, LLC dba "**onsemi**" or its affiliates and/or subsidiaries in the United States and/or other countries. **onsemi** owns the rights to a number of patents, trademarks, copyrights, trade secrets, and other intellectual property. A listing of **onsemi**'s product/patent coverage may be accessed at www.onsemi.com/site/pdf/Patent-Marking.pdf. **onsemi** reserves the right to make changes at any time to any products or information herein, without notice. The information herein is provided "as-is" and **onsemi** makes no warranty, representation or guarantee regarding the accuracy of the information, product features, availability, functionality, or suitability of its products for any particular purpose, nor does **onsemi** assume any liability arising out of the application or use of any product or circuit, and specifically disclaims any and all liability, including without limitation special, consequential or incidental damages. Buyer is responsible for its products and applications using **onsemi** products, including compliance with all laws, regulations and safety requirements or standards, regardless of any support or applications information provided by **onsemi**. "Typical" parameters which may be provided in **onsemi** data sheets and/or specifications can and do vary in different applications and actual performance may vary over time. All operating parameters, including "Typicals" must be validated for each customer application by customer's technical experts. **onsemi** does not convey any license under any of its intellectual property rights nor the rights of others. **onsemi** products are not designed, intended, or authorized for use as a critical component in life support systems or any FDA Class 3 medical devices or medical devices with a same or similar classification in a foreign jurisdiction or any devices intended for implantation in the human body. Should Buyer purchase or use **onsemi** products for any such unintended or unauthorized application, Buyer shall indemnify and hold **onsemi** and its officers, employees, subsidiaries, affiliates, and distributors harmless against all claims, costs, damages, and expenses, and reasonable attorney fees arising out of, directly or indirectly, any claim of personal injury or death associated with such unintended or unauthorized use, even if such claim alleges that **onsemi** was negligent regarding the design or manufacture of the part. **onsemi** is an Equal Opportunity/Affirmative Action Employer. This literature is subject to all applicable copyright laws and is not for resale in any manner.

ADDITIONAL INFORMATION

TECHNICAL PUBLICATIONS:

Technical Library: www.onsemi.com/design/resources/technical-documentation
onsemi Website: www.onsemi.com

ONLINE SUPPORT: www.onsemi.com/support

For additional information, please contact your local Sales Representative at www.onsemi.com/support/sales

OUR CERTIFICATE

DiGi provide top-quality products and perfect service for customer worldwide through standardization, technological innovation and continuous improvement. DiGi through third-party certification, we stricly control the quality of products and services. Welcome your RFQ to

Email: Info@DiGi-Electronics.com



Tel: +00 852-30501935

RFQ Email: Info@DiGi-Electronics.com

DiGi is a global authorized distributor of electronic components.