

KSC1845PTA Datasheet

www.digi-electronics.com



<https://www.DiGi-Electronics.com>

DiGi Electronics Part Number	KSC1845PTA-DG
Manufacturer	onsemi
Manufacturer Product Number	KSC1845PTA
Description	TRANS NPN 120V 0.05A TO92-3
Detailed Description	Bipolar (BJT) Transistor NPN 120 V 50 mA 110MHz 500 mW Through Hole TO-92-3



Tel: +00 852-30501935

RFQ Email: Info@DiGi-Electronics.com

DiGi is a global authorized distributor of electronic components.

Purchase and inquiry

Manufacturer Product Number:

KSC1845PTA

Series:

-

Transistor Type:

NPN

Voltage - Collector Emitter Breakdown (Max):

120 V

Current - Collector Cutoff (Max):

50nA (ICBO)

Power - Max:

500 mW

Operating Temperature:

150°C (TJ)

Package / Case:

TO-226-3, TO-92-3 (TO-226AA) Formed Leads

Base Product Number:

KSC1845

Manufacturer:

onsemi

Product Status:

Obsolete

Current - Collector (Ic) (Max):

50 mA

Vce Saturation (Max) @ Ib, Ic:

300mV @ 1mA, 10mA

DC Current Gain (hFE) (Min) @ Ic, Vce:

200 @ 1mA, 6V

Frequency - Transition:

110MHz

Mounting Type:

Through Hole

Supplier Device Package:

TO-92-3

Environmental & Export classification

Moisture Sensitivity Level (MSL):

1 (Unlimited)

ECCN:

EAR99

REACH Status:

REACH Unaffected

HTSUS:

8541.21.0075

NPN Epitaxial Silicon Transistor

KSC1845

Features

- Audio Frequency Low-Noise Amplifier
- Complement to KSA992
- This is a Pb-Free Device

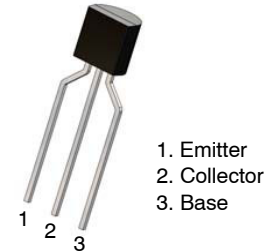

TO-92 3 4.83x4.76
LEADFORMED
CASE 135AR

MAXIMUM RATINGS (Values are at $T_A = 25^\circ\text{C}$ unless otherwise noted.)

Symbol	Parameter	Value	Unit
V_{CBO}	Collector-Base Voltage	120	V
V_{CEO}	Collector-Emitter Voltage	120	V
V_{EBO}	Emitter-Base Voltage	5	V
I_C	Collector Current	50	mA
I_B	Base Current	10	mA
T_J	Junction Temperature	150	$^\circ\text{C}$
T_{STG}	Storage Temperature	-55 to 150	$^\circ\text{C}$

Stresses exceeding those listed in the Maximum Ratings table may damage the device. If any of these limits are exceeded, device functionality should not be assumed, damage may occur and reliability may be affected.

THERMAL CHARACTERISTICS

(Values are at $T_A = 25^\circ\text{C}$ unless otherwise noted.) (Note 1)

Symbol	Parameter	Value	Unit
P_D	Power Dissipation	500	mW
	Derate Above 25°C	4	mW/ $^\circ\text{C}$
$R_{\theta JA}$	Thermal Resistance, Junction-to-Ambient	250	$^\circ\text{C}/\text{W}$

1. PCB size: FR-4, 76 mm x 114 mm x 1.57 mm (3.0 inch x 4.5 inch x 0.062 inch) with minimum land pattern size.

MARKING DIAGRAM

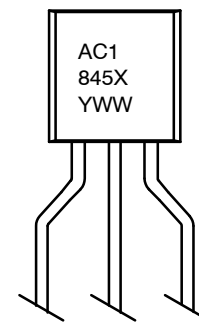

A = Assembly Code
C1845 = Device Code
X = F
YWW = Date Code

ORDERING INFORMATION

Device	Package	Shipping
KSC1845FTA	TO-92 3 LF (Pb-Free)	2000 / Fan-Fold

KSC1845**ELECTRICAL CHARACTERISTICS** (Values are at $T_A = 25^\circ\text{C}$ unless otherwise noted.)

Symbol	Parameter	Conditions	Min	Typ	Max	Unit
BV_{CBO}	Collector-Base Breakdown Voltage	$I_C = 100 \mu\text{A}, I_A = 0$	120	-	-	V
BV_{CEO}	Collector-Emitter Breakdown Voltage	$I_C = 1 \text{ mA}, I_B = 0$	120	-	-	V
BV_{EBO}	Emitter-Base Breakdown Voltage	$I_E = 100 \mu\text{A}, I_C = 0$	5	-	-	V
I_{CBO}	Collector Cut-Off Current	$V_{CB} = 120 \text{ V}, I_E = 0$	-	-	50	nA
I_{EBO}	Emitter Cut-Off Current	$V_{EB} = 5 \text{ V}, I_C = 0$	-	-	50	nA
h_{FE1}	DC Current Gain	$V_{CE} = 6 \text{ V}, I_C = 0.1 \text{ mA}$	150	580	-	
h_{FE2}		$V_{CE} = 6 \text{ V}, I_C = 1 \text{ mA}$	300	450	600	
$V_{BE(on)}$	Base-Emitter On Voltage	$V_{CE} = 6 \text{ V}, I_C = 1 \text{ mA}$	0.55	0.59	0.65	V
$V_{CE(sat)}$	Collector-Emitter Saturation Voltage	$I_C = 10 \text{ mA}, I_B = 1 \text{ mA}$	-	0.07	0.30	V
f_T	Current Gain Bandwidth Product	$V_{CE} = 6 \text{ V}, I_C = 1 \text{ mA}$	50	100	-	MHz
C_{ob}	Output Capacitance	$V_{CB} = 30 \text{ V}, I_E = 0, f = 1 \text{ MHz}$	-	1.6	2.5	pF
NF	Noise Figure	$V_{CE} = -5 \text{ V}, I_C = -1.0 \text{ mA}, R_S = 100 \text{ k}\Omega, f = 1 \text{ kHz}$	-	7	-	dB

Product parametric performance is indicated in the Electrical Characteristics for the listed test conditions, unless otherwise noted. Product performance may not be indicated by the Electrical Characteristics if operated under different conditions.

KSC1845

TYPICAL PERFORMANCE CHARACTERISTICS

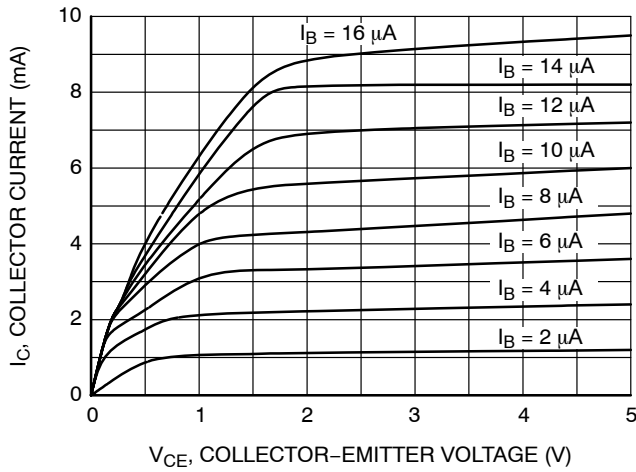

Figure 1. Static Characteristic

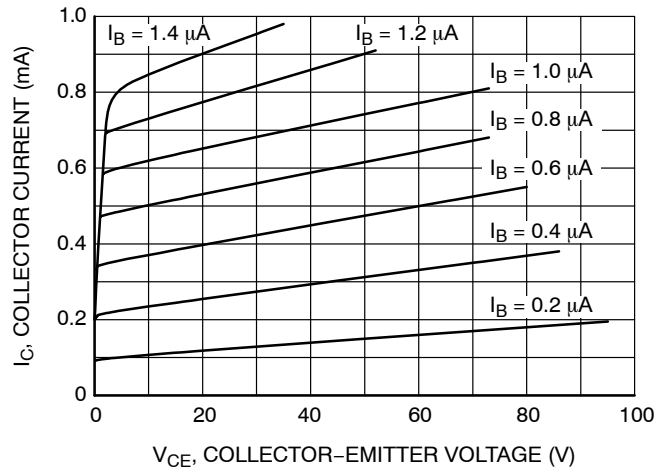

Figure 2. Static Characteristic

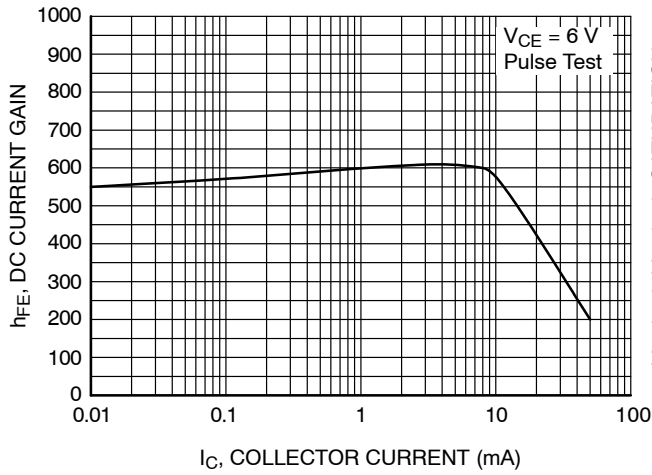

Figure 3. DC Current Gain

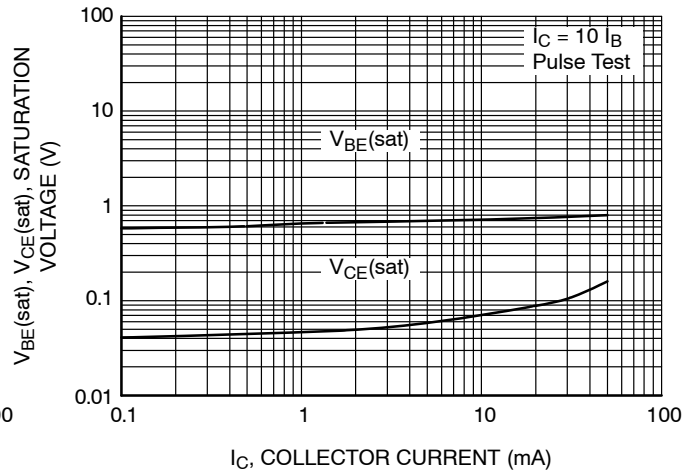

Figure 4. Base-Emitter Saturation Voltage and Collector-Emitter Saturation Voltage

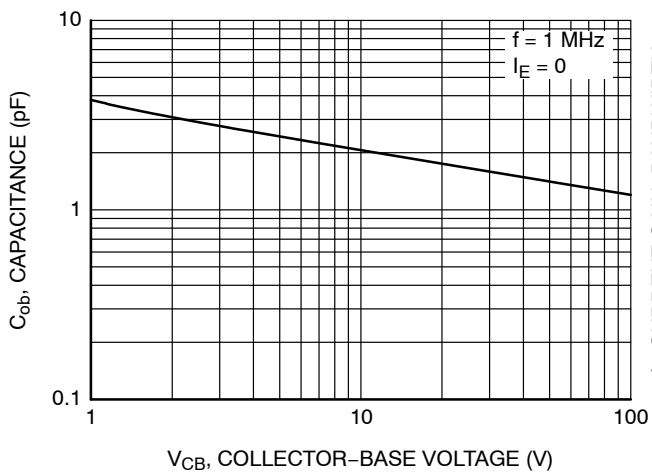

Figure 5. Collector Output Capacitance

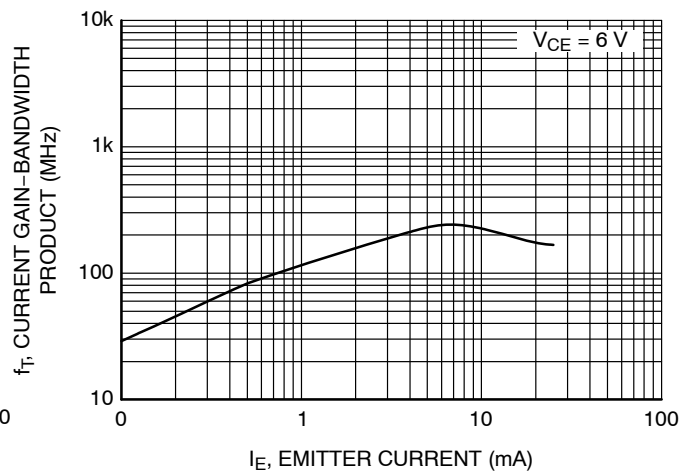

Figure 6. Current Gain Bandwidth Product

KSC1845

TYPICAL PERFORMANCE CHARACTERISTICS (Continued)

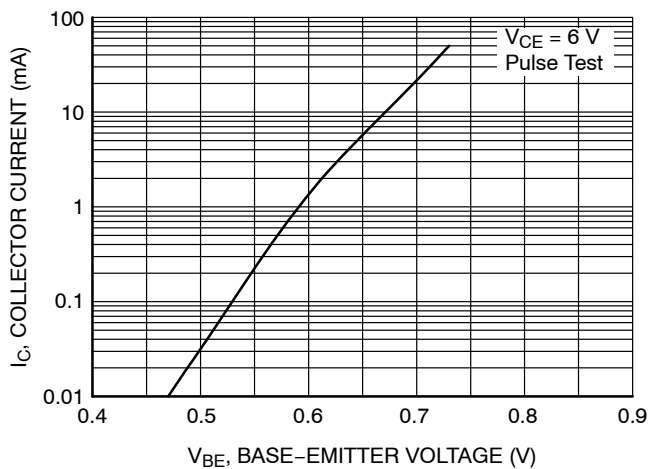

Figure 7. Collector Current vs. Base-Emitter Voltage

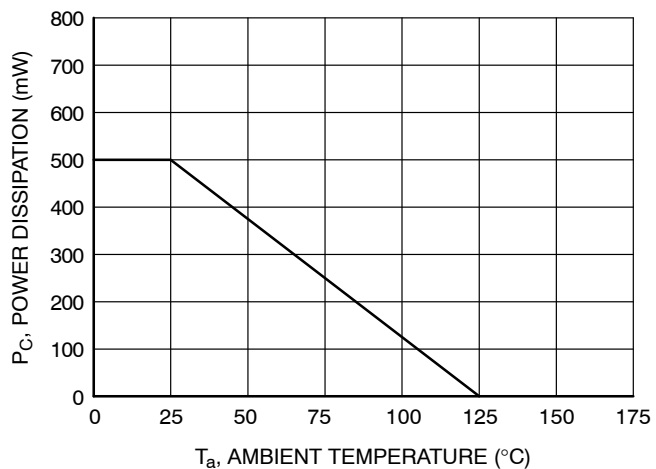
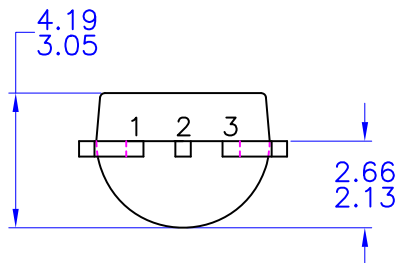
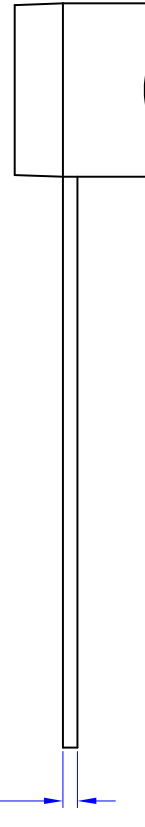
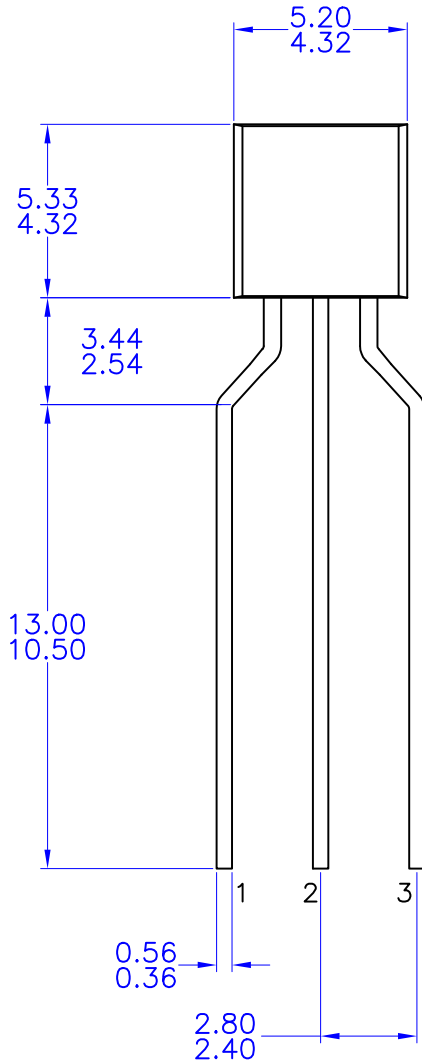

Figure 8. Power Derating

TO-92 3 4.83x4.76 LEADFORMED
CASE 135AR
ISSUE O

DATE 30 SEP 2016



NOTES: UNLESS OTHERWISE SPECIFIED

- A) DRAWING WITH REFERENCE TO JEDEC TO-92 RECOMMENDATIONS.
- B) ALL DIMENSIONS ARE IN MILLIMETERS.
- C) DRAWING CONFORMS TO ASME Y14.5M-1994

DOCUMENT NUMBER:	98AON13879G	Electronic versions are uncontrolled except when accessed directly from the Document Repository. Printed versions are uncontrolled except when stamped "CONTROLLED COPY" in red.
DESCRIPTION:	TO-92 3 4.83X4.76 LEADFORMED	PAGE 1 OF 1

onsemi and ONSEMI are trademarks of Semiconductor Components Industries, LLC dba onsemi or its subsidiaries in the United States and/or other countries. onsemi reserves the right to make changes without further notice to any products herein. onsemi makes no warranty, representation or guarantee regarding the suitability of its products for any particular purpose, nor does onsemi assume any liability arising out of the application or use of any product or circuit, and specifically disclaims any and all liability, including without limitation special, consequential or incidental damages. onsemi does not convey any license under its patent rights nor the rights of others.

onsemi, **Onsemi**, and other names, marks, and brands are registered and/or common law trademarks of Semiconductor Components Industries, LLC dba "**onsemi**" or its affiliates and/or subsidiaries in the United States and/or other countries. **onsemi** owns the rights to a number of patents, trademarks, copyrights, trade secrets, and other intellectual property. A listing of **onsemi**'s product/patent coverage may be accessed at www.onsemi.com/site/pdf/Patent-Marking.pdf. **onsemi** reserves the right to make changes at any time to any products or information herein, without notice. The information herein is provided "as-is" and **onsemi** makes no warranty, representation or guarantee regarding the accuracy of the information, product features, availability, functionality, or suitability of its products for any particular purpose, nor does **onsemi** assume any liability arising out of the application or use of any product or circuit, and specifically disclaims any and all liability, including without limitation special, consequential or incidental damages. Buyer is responsible for its products and applications using **onsemi** products, including compliance with all laws, regulations and safety requirements or standards, regardless of any support or applications information provided by **onsemi**. "Typical" parameters which may be provided in **onsemi** data sheets and/or specifications can and do vary in different applications and actual performance may vary over time. All operating parameters, including "Typicals" must be validated for each customer application by customer's technical experts. **onsemi** does not convey any license under any of its intellectual property rights nor the rights of others. **onsemi** products are not designed, intended, or authorized for use as a critical component in life support systems or any FDA Class 3 medical devices or medical devices with a same or similar classification in a foreign jurisdiction or any devices intended for implantation in the human body. Should Buyer purchase or use **onsemi** products for any such unintended or unauthorized application, Buyer shall indemnify and hold **onsemi** and its officers, employees, subsidiaries, affiliates, and distributors harmless against all claims, costs, damages, and expenses, and reasonable attorney fees arising out of, directly or indirectly, any claim of personal injury or death associated with such unintended or unauthorized use, even if such claim alleges that **onsemi** was negligent regarding the design or manufacture of the part. **onsemi** is an Equal Opportunity/Affirmative Action Employer. This literature is subject to all applicable copyright laws and is not for resale in any manner.

ADDITIONAL INFORMATION

TECHNICAL PUBLICATIONS:

Technical Library: www.onsemi.com/design/resources/technical-documentation
onsemi Website: www.onsemi.com

ONLINE SUPPORT: www.onsemi.com/support

For additional information, please contact your local Sales Representative at www.onsemi.com/support/sales

OUR CERTIFICATE

DiGi provide top-quality products and perfect service for customer worldwide through standardization, technological innovation and continuous improvement. DiGi through third-party certification, we strictly control the quality of products and services. Welcome your RFQ to

Email: Info@DiGi-Electronics.com



Tel: +00 852-30501935

RFQ Email: Info@DiGi-Electronics.com

DiGi is a global authorized distributor of electronic components.