

KSP44TF Datasheet

www.digi-electronics.com



<https://www.DiGi-Electronics.com>

DiGi Electronics Part Number	KSP44TF-DG
Manufacturer	onsemi
Manufacturer Product Number	KSP44TF
Description	TRANS NPN 400V 0.3A TO92-3
Detailed Description	Bipolar (BJT) Transistor NPN 400 V 300 mA 625 mW Through Hole TO-92-3



Tel: +00 852-30501935

RFQ Email: Info@DiGi-Electronics.com

DiGi is a global authorized distributor of electronic components.

Purchase and inquiry

Manufacturer Product Number:

KSP44TF

Series:

-

Transistor Type:

NPN

Voltage - Collector Emitter Breakdown (Max):

400 V

Current - Collector Cutoff (Max):

500nA

Power - Max:

625 mW

Operating Temperature:

150°C (TJ)

Package / Case:

TO-226-3, TO-92-3 (TO-226AA) Formed Leads

Base Product Number:

KSP44

Manufacturer:

onsemi

Product Status:

Active

Current - Collector (Ic) (Max):

300 mA

Vce Saturation (Max) @ Ib, Ic:

750mV @ 5mA, 50mA

DC Current Gain (hFE) (Min) @ Ic, Vce:

50 @ 10mA, 10V

Frequency - Transition:

-

Mounting Type:

Through Hole

Supplier Device Package:

TO-92-3

Environmental & Export classification

RoHS Status:

ROHS3 Compliant

REACH Status:

REACH Unaffected

HTSUS:

8541.21.0095

Moisture Sensitivity Level (MSL):

Not Applicable

ECCN:

EAR99

NPN Epitaxial Silicon Transistor

KSP44, KSP45

Features

- High-Voltage Transistor
- Collector-Emitter Voltage:
 - ◆ KSP44: $V_{CEO} = 400\text{ V}$
 - ◆ KSP45: $V_{CEO} = 350\text{ V}$
- These Devices are Pb-Free, Halogen Free/BFR Free and are RoHS Compliant

ABSOLUTE MAXIMUM RATINGS

Values are at $T_A = 25^\circ\text{C}$ unless otherwise noted.

Symbol	Parameter		Value	Unit
V_{CBO}	Collector-Base Voltage	KSP44	500	V
		KSP45	400	
V_{CEO}	Collector-Emitter Voltage	KSP44	400	V
		KSP45	350	
V_{EBO}	Emitter-Base Voltage		6	V
I_C	Collector Current		300	mA
T_J	Junction Temperature		150	$^\circ\text{C}$
T_{STG}	Storage Temperature		-55 to 150	$^\circ\text{C}$

Stresses exceeding those listed in the Maximum Ratings table may damage the device. If any of these limits are exceeded, device functionality should not be assumed, damage may occur and reliability may be affected.

THERMAL CHARACTERISTICS (Note 1)

Values are at $T_A = 25^\circ\text{C}$ unless otherwise noted.

Symbol	Parameter		Value	Unit
P_D	Power Dissipation	$T_A = 25^\circ\text{C}$	625	mW
		$T_C = 25^\circ\text{C}$	1.5	W
$R_{\theta JC}$	Thermal Resistance, Junction-to-Case		83.3	$^\circ\text{C}/\text{W}$
$R_{\theta JA}$	Thermal Resistance, Junction-to-Ambient		200	$^\circ\text{C}/\text{W}$

1. PCB size: FR-4, 76 mm x 114 mm x 1.57 mm (3.0 inch x 4.5 inch x 0.062 inch) with minimum land pattern size.

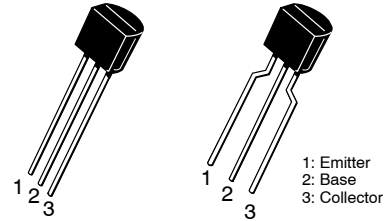

STRAIGHT LEAD
BULK PACK

TO-92-3
CASE 135AN

BENT LEAD
TAPE & REEL
AMMO PACK

TO-92 LF
CASE 135AR

MARKING DIAGRAM

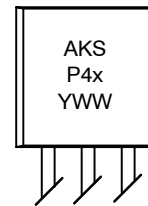

A = Assembly Code
 KSP4x = Device Code (x = 4 or 5)
 Y = Year
 WW = Work Week

ORDERING INFORMATION

See detailed ordering and shipping information on page 2 of this data sheet.

KSP44, KSP45**ORDERING INFORMATION**

Part Number	Top Mark	Package	Shipping [†]
KSP44BU	KSP44	TO-92-3 (Pb-Free), case 135AN	10,000 units / Bulk Bag
KSP44TA	KSP44	TO-92-3 (Pb-Free), case 135AR	2,000 units / Fan-Fold
KSP44TF	KSP44	TO-92-3 (Pb-Free), case 135AR	2,000 units / Tape & Reel
KSP45TA	KSP45	TO-92-3 (Pb-Free), case 135AR	2,000 units / Fan-Fold

[†]For information on tape and reel specifications, including part orientation and tape sizes, please refer to our Tape and Reel Packaging Specifications Brochure, BRD8011/D.

ELECTRICAL CHARACTERISTICS

(Values are at $T_A = 25^\circ\text{C}$ unless otherwise noted.)

Symbol	Parameter	Conditions	Min.	Max.	Unit	
BV _{CBO}	Collector-Base Breakdown Voltage	KSP44	I _C = 100 μA , I _E = 0	500		V
		KSP45		400		
BV _{CEO}	Collector-Emitter Breakdown Voltage (Note 2)	KSP44	I _C = 1 mA, I _B = 0	400		V
		KSP45		350		
BV _{EBO}	Emitter-Base Breakdown Voltage	I _E = 100 μA , I _C = 0	6		V	
I _{CBO}	Collector Cut-Off Current	KSP44	V _{CB} = 400 V, I _E = 0		0.1	μA
		KSP45		V _{CB} = 320 V, I _E = 0		
I _{CES}	Collector Cut-Off Current	KSP44	V _{CE} = 400 V, I _E = 0		0.5	μA
		KSP45		V _{CE} = 320 V, I _E = 0		
I _{EBO}	Emitter Cut-Off Current	V _{EB} = 4 V, I _C = 0		0.1	μA	
h _{FE}	DC Current Gain (Note 2)	V _{CE} = 10 V, I _C = 1 mA	40			
		V _{CE} = 10 V, I _C = 10 mA	50	200		
		V _{CE} = 10 V, I _C = 50 mA	45			
		V _{CE} = 10 V, I _C = 100 mA	40			
V _{CE(sat)}	Collector-Emitter Saturation Voltage (Note 2)	I _C = 1 mA, I _B = 0.1 mA		0.40	V	
		I _C = 10 mA, I _B = 1 mA		0.50		
		I _C = 50 mA, I _B = 5 mA		0.75		
V _{BE(sat)}	Base-Emitter Saturation Voltage (Note 2)	I _C = 10 mA, I _B = 1 mA		0.75	V	
C _{ob}	Output Capacitance	V _{CB} = 20 V, I _E = 0, f = 1 MHz		7	pF	

Product parametric performance is indicated in the Electrical Characteristics for the listed test conditions, unless otherwise noted. Product performance may not be indicated by the Electrical Characteristics if operated under different conditions.

2. Pulse test: pulse width $\leq 300 \mu\text{s}$, duty cycle $\leq 2\%$.

KSP44, KSP45

TYPICAL PERFORMANCE CHARACTERISTICS

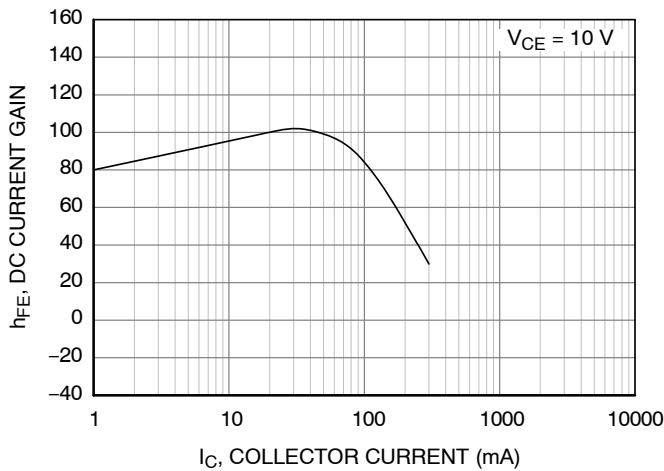

Figure 1. DC Current Gain

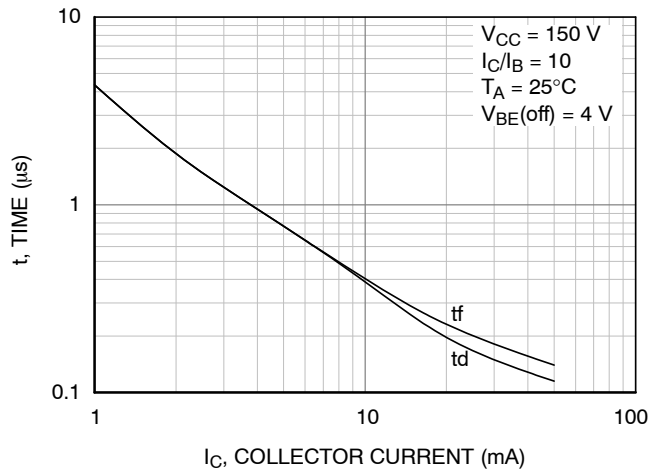

Figure 2. Turn-On Switching Times

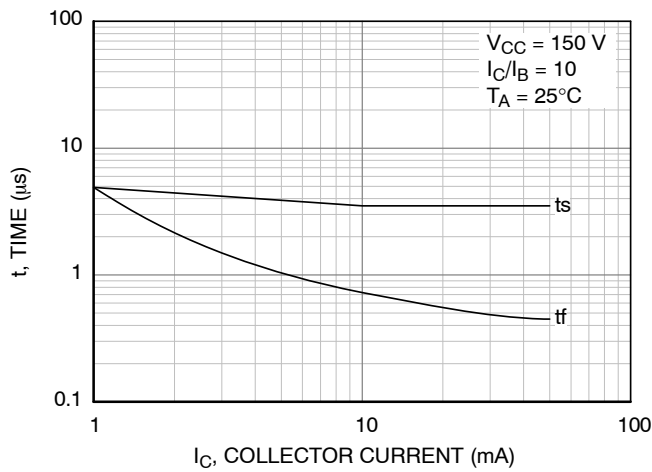

Figure 3. Turn-Off Switching Times

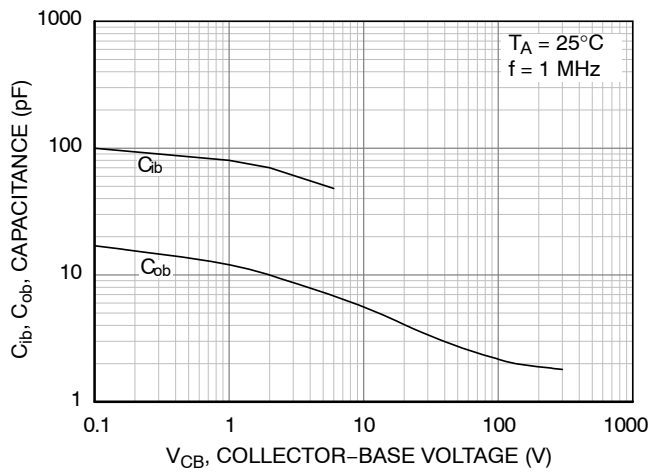

Figure 4. Capacitance

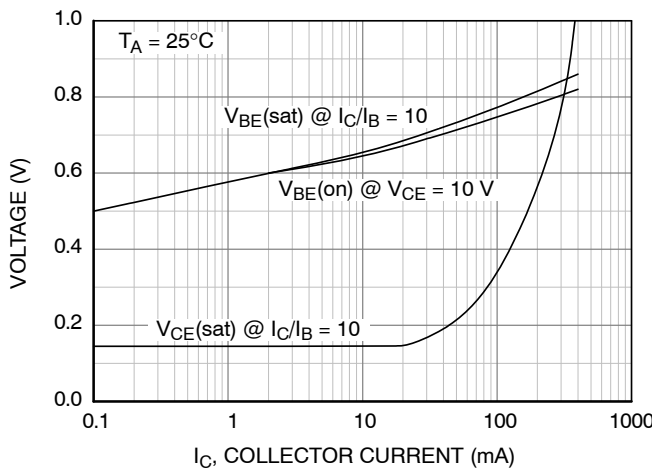

Figure 5. On Voltage

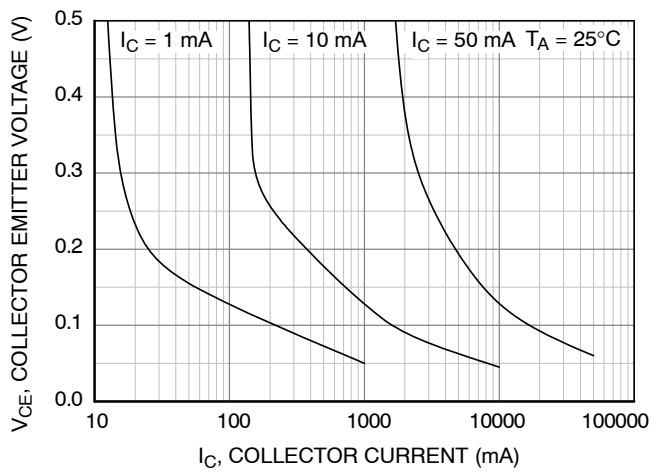

Figure 6. Collector Saturation Region

KSP44, KSP45

TYPICAL PERFORMANCE CHARACTERISTICS (continued)

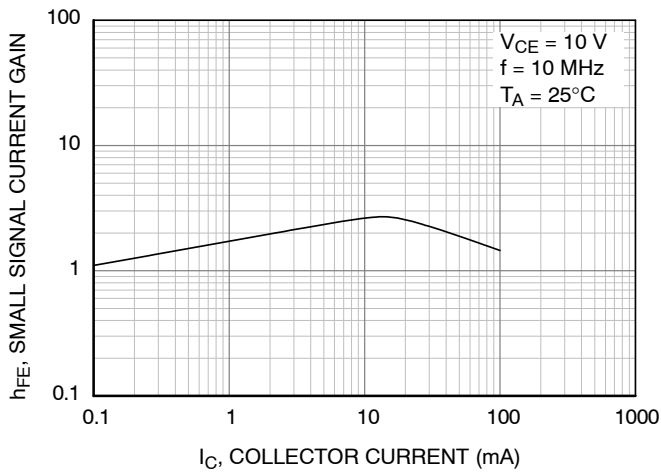

Figure 7. High-Frequency Current Gain

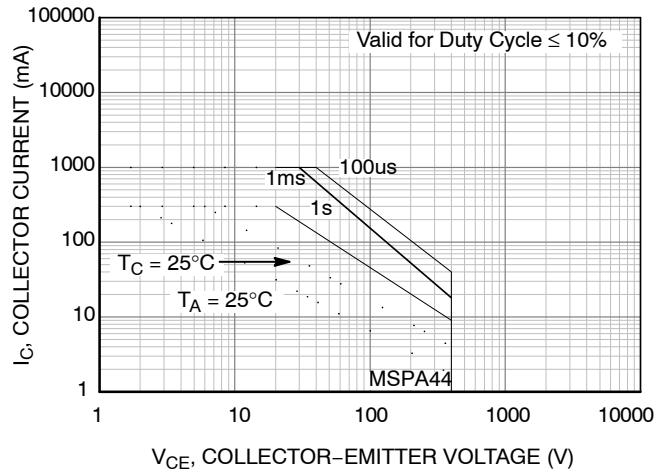
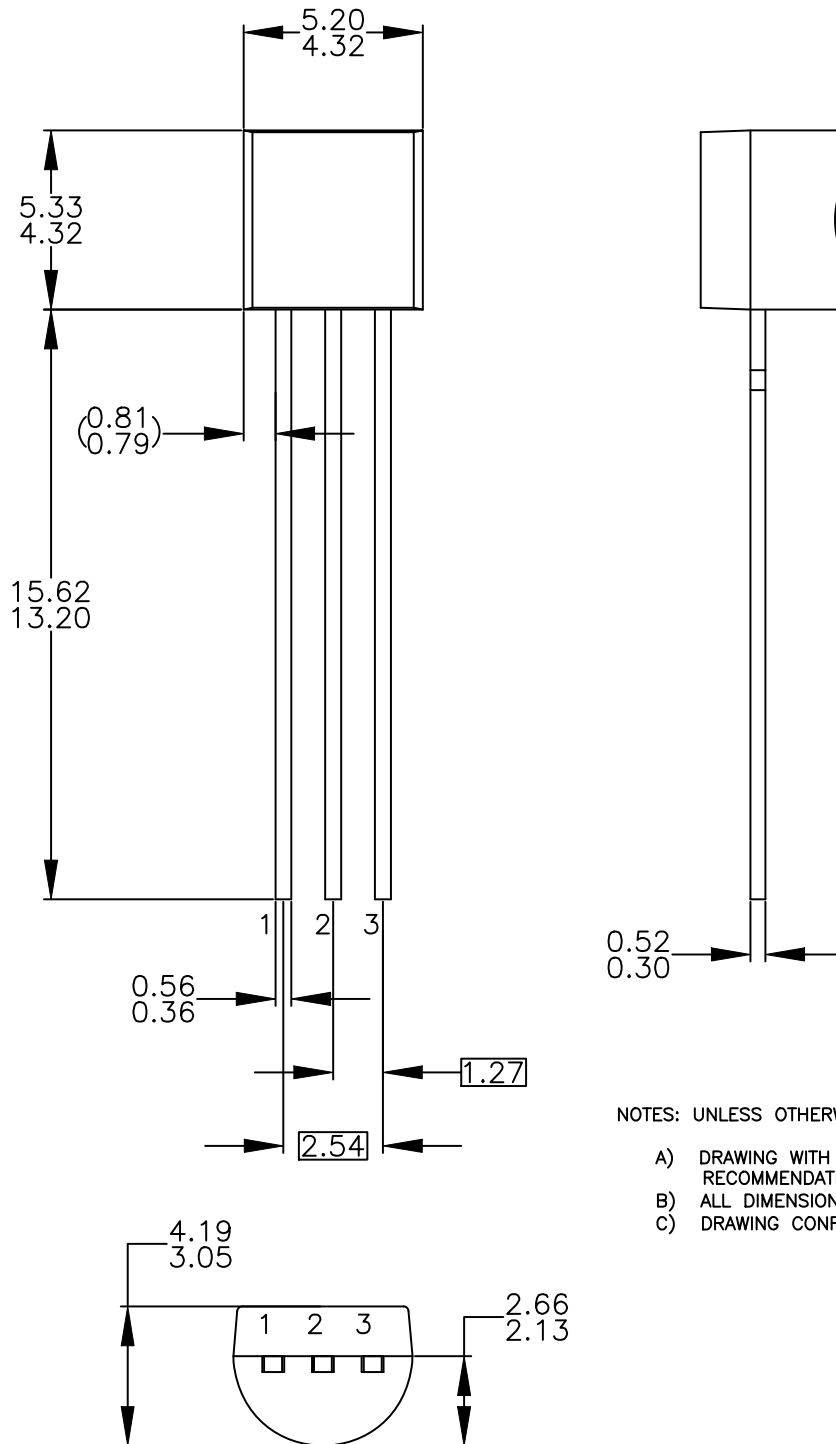

Figure 8. Safe Operating Area

TO-92 3 4.825x4.76
CASE 135AN
ISSUE O

DATE 31 JUL 2016



NOTES: UNLESS OTHERWISE SPECIFIED

- A) DRAWING WITH REFERENCE TO JEDEC TO-92 RECOMMENDATIONS.
- B) ALL DIMENSIONS ARE IN MILLIMETERS.
- C) DRAWING CONFORMS TO ASME Y14.5M-2009.

DOCUMENT NUMBER:	98AON13880G	Electronic versions are uncontrolled except when accessed directly from the Document Repository. Printed versions are uncontrolled except when stamped "CONTROLLED COPY" in red.
DESCRIPTION:	TO-92 3 4.825X4.76	PAGE 1 OF 1

onsemi and ONSEMI are trademarks of Semiconductor Components Industries, LLC dba onsemi or its subsidiaries in the United States and/or other countries. onsemi reserves the right to make changes without further notice to any products herein. onsemi makes no warranty, representation or guarantee regarding the suitability of its products for any particular purpose, nor does onsemi assume any liability arising out of the application or use of any product or circuit, and specifically disclaims any and all liability, including without limitation special, consequential or incidental damages. onsemi does not convey any license under its patent rights nor the rights of others.

TO-92 3 4.83x4.76 LEADFORMED
CASE 135AR
ISSUE O

DATE 30 SEP 2016

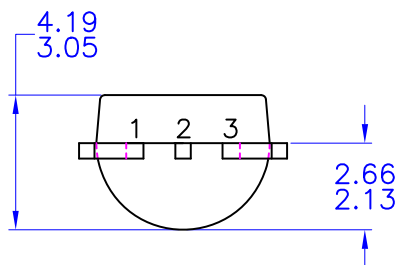
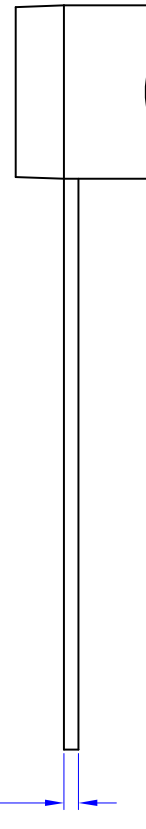
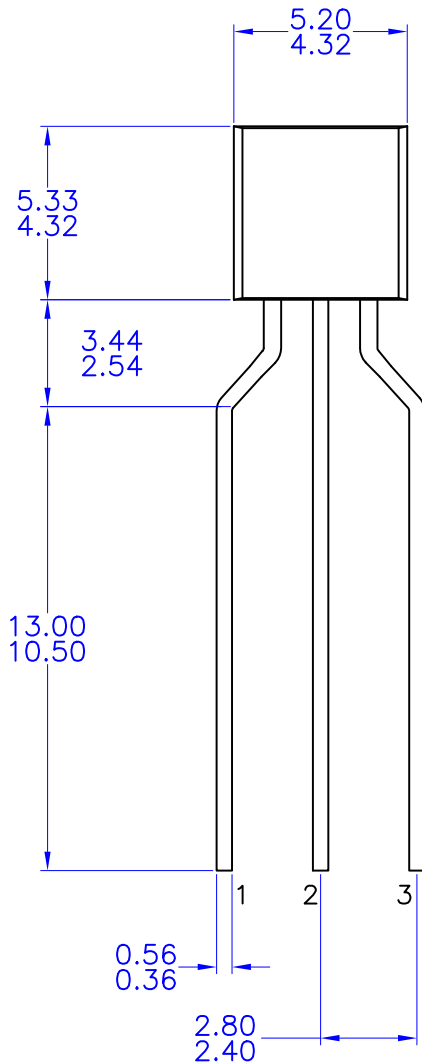

NOTES: UNLESS OTHERWISE SPECIFIED

- A) DRAWING WITH REFERENCE TO JEDEC TO-92 RECOMMENDATIONS.
- B) ALL DIMENSIONS ARE IN MILLIMETERS.
- C) DRAWING CONFORMS TO ASME Y14.5M-1994

DOCUMENT NUMBER:	98AON13879G	Electronic versions are uncontrolled except when accessed directly from the Document Repository. Printed versions are uncontrolled except when stamped "CONTROLLED COPY" in red.
DESCRIPTION:	TO-92 3 4.83X4.76 LEADFORMED	PAGE 1 OF 1

onsemi and ONSEMI are trademarks of Semiconductor Components Industries, LLC dba onsemi or its subsidiaries in the United States and/or other countries. onsemi reserves the right to make changes without further notice to any products herein. onsemi makes no warranty, representation or guarantee regarding the suitability of its products for any particular purpose, nor does onsemi assume any liability arising out of the application or use of any product or circuit, and specifically disclaims any and all liability, including without limitation special, consequential or incidental damages. onsemi does not convey any license under its patent rights nor the rights of others.

onsemi, **Onsemi**, and other names, marks, and brands are registered and/or common law trademarks of Semiconductor Components Industries, LLC dba "**onsemi**" or its affiliates and/or subsidiaries in the United States and/or other countries. **onsemi** owns the rights to a number of patents, trademarks, copyrights, trade secrets, and other intellectual property. A listing of **onsemi**'s product/patent coverage may be accessed at www.onsemi.com/site/pdf/Patent-Marking.pdf. **onsemi** reserves the right to make changes at any time to any products or information herein, without notice. The information herein is provided "as-is" and **onsemi** makes no warranty, representation or guarantee regarding the accuracy of the information, product features, availability, functionality, or suitability of its products for any particular purpose, nor does **onsemi** assume any liability arising out of the application or use of any product or circuit, and specifically disclaims any and all liability, including without limitation special, consequential or incidental damages. Buyer is responsible for its products and applications using **onsemi** products, including compliance with all laws, regulations and safety requirements or standards, regardless of any support or applications information provided by **onsemi**. "Typical" parameters which may be provided in **onsemi** data sheets and/or specifications can and do vary in different applications and actual performance may vary over time. All operating parameters, including "Typicals" must be validated for each customer application by customer's technical experts. **onsemi** does not convey any license under any of its intellectual property rights nor the rights of others. **onsemi** products are not designed, intended, or authorized for use as a critical component in life support systems or any FDA Class 3 medical devices or medical devices with a same or similar classification in a foreign jurisdiction or any devices intended for implantation in the human body. Should Buyer purchase or use **onsemi** products for any such unintended or unauthorized application, Buyer shall indemnify and hold **onsemi** and its officers, employees, subsidiaries, affiliates, and distributors harmless against all claims, costs, damages, and expenses, and reasonable attorney fees arising out of, directly or indirectly, any claim of personal injury or death associated with such unintended or unauthorized use, even if such claim alleges that **onsemi** was negligent regarding the design or manufacture of the part. **onsemi** is an Equal Opportunity/Affirmative Action Employer. This literature is subject to all applicable copyright laws and is not for resale in any manner.

ADDITIONAL INFORMATION

TECHNICAL PUBLICATIONS:

Technical Library: www.onsemi.com/design/resources/technical-documentation
onsemi Website: www.onsemi.com

ONLINE SUPPORT: www.onsemi.com/support

For additional information, please contact your local Sales Representative at www.onsemi.com/support/sales

OUR CERTIFICATE

DiGi provide top-quality products and perfect service for customer worldwide through standardization, technological innovation and continuous improvement. DiGi through third-party certification, we stricly control the quality of products and services. Welcome your RFQ to

Email: Info@DiGi-Electronics.com



Tel: +00 852-30501935

RFQ Email: Info@DiGi-Electronics.com

DiGi is a global authorized distributor of electronic components.