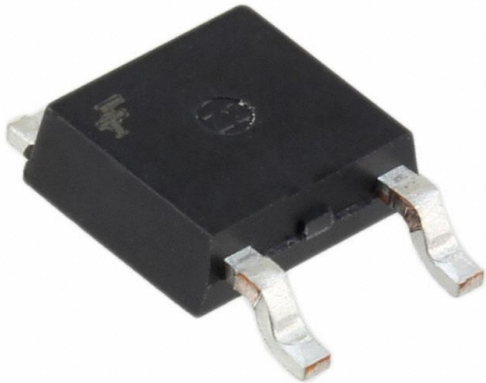


# MJD44H11TF Datasheet

[www.digi-electronics.com](http://www.digi-electronics.com)



<https://www.DiGi-Electronics.com>

DiGi Electronics Part Number	MJD44H11TF-DG
Manufacturer	<a href="#">onsemi</a>
Manufacturer Product Number	MJD44H11TF
Description	TRANS NPN 80V 8A DPAK
Detailed Description	Bipolar (BJT) Transistor NPN 80 V 8 A 50MHz 1.75 W Surface Mount DPAK



Tel: +00 852-30501935

RFQ Email: [Info@DiGi-Electronics.com](mailto:Info@DiGi-Electronics.com)

DiGi is a global authorized distributor of electronic components.

## Purchase and inquiry

Manufacturer Product Number:

MJD44H11TF

Series:

-

Transistor Type:

NPN

Voltage - Collector Emitter Breakdown (Max):

80 V

Current - Collector Cutoff (Max):

10 $\mu$ A

Power - Max:

1.75 W

Operating Temperature:

150°C (TJ)

Package / Case:

TO-252-3, DPAK (2 Leads + Tab), SC-63

Base Product Number:

MJD44

Manufacturer:

onsemi

Product Status:

Obsolete

Current - Collector (Ic) (Max):

8 A

Vce Saturation (Max) @ Ib, Ic:

1V @ 400mA, 8A

DC Current Gain (hFE) (Min) @ Ic, Vce:

40 @ 4A, 1V

Frequency - Transition:

50MHz

Mounting Type:

Surface Mount

Supplier Device Package:

DPAK

## Environmental & Export classification

RoHS Status:

ROHS3 Compliant

REACH Status:

REACH Unaffected

HTSUS:

8541.29.0075

Moisture Sensitivity Level (MSL):

1 (Unlimited)

ECCN:

EAR99



# Complementary Power Transistors

## DPAK for Surface Mount Applications

### MJD44H11 (NPN), MJD45H11 (PNP)

Designed for general purpose power and switching such as output or driver stages in applications such as switching regulators, converters, and power amplifiers.

#### Features

- Lead Formed for Surface Mount Application in Plastic Sleeves (No Suffix)
- Straight Lead Version in Plastic Sleeves (“-1” Suffix)
- Electrically Similar to Popular D44H/D45H Series
- Low Collector Emitter Saturation Voltage
- Fast Switching Speeds
- Complementary Pairs Simplifies Designs
- Epoxy Meets UL 94 V-0 @ 0.125 in
- NJV Prefix for Automotive and Other Applications Requiring Unique Site and Control Change Requirements; AEC-Q101 Qualified and PPAP Capable
- These Devices are Pb-Free, Halogen Free/BFR Free and are RoHS Compliant

**MAXIMUM RATINGS** ( $T_A = 25^\circ\text{C}$ , common for NPN and PNP, minus sign, “-”, for PNP omitted, unless otherwise noted)

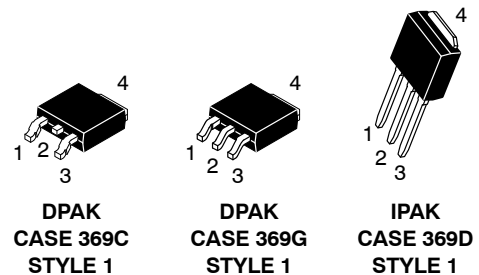
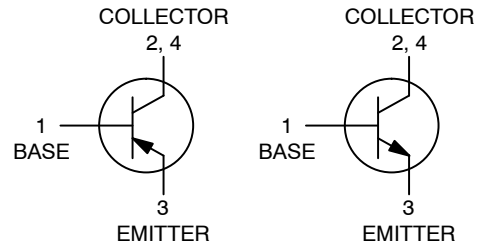
Rating	Symbol	Max	Unit
Collector-Emitter Voltage	$V_{CEO}$	80	Vdc
Emitter-Base Voltage	$V_{EB}$	5	Vdc
Collector Current - Continuous	$I_C$	8	Adc
Collector Current - Peak	$I_{CM}$	16	Adc
Total Power Dissipation @ $T_C = 25^\circ\text{C}$ Derate above $25^\circ\text{C}$	$P_D$	20 0.16	W W/ $^\circ\text{C}$
Total Power Dissipation (Note 1) @ $T_A = 25^\circ\text{C}$ Derate above $25^\circ\text{C}$	$P_D$	1.75 0.014	W W/ $^\circ\text{C}$
Operating and Storage Junction Temperature Range	$T_J, T_{stg}$	-55 to +150	$^\circ\text{C}$
ESD - Human Body Model	HBM	3B	V
ESD - Machine Model	MM	C	V

Stresses exceeding those listed in the Maximum Ratings table may damage the device. If any of these limits are exceeded, device functionality should not be assumed, damage may occur and reliability may be affected.

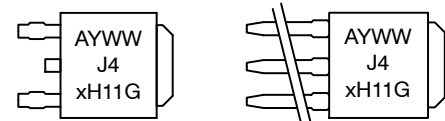
1. These ratings are applicable when surface mounted on the minimum pad sizes recommended.

## SILICON POWER TRANSISTORS 8 AMPERES 80 VOLTS, 20 WATTS

#### COMPLEMENTARY



#### MARKING DIAGRAMS



DPAK	IPAK
A	= Assembly Location
Y	= Year
WW	= Work Week
J4xH11	= Device Code x = 4 or 5
G	= Pb-Free Package

#### ORDERING INFORMATION

See detailed ordering and shipping information in the package dimensions section on page 7 of this data sheet.

**MJD44H11 (NPN), MJD45H11 (PNP)****THERMAL CHARACTERISTICS**

Characteristic	Symbol	Max	Unit
Thermal Resistance, Junction-to-Case	$R_{\theta JC}$	6.25	$^{\circ}C/W$
Thermal Resistance, Junction-to-Ambient (Note 2)	$R_{\theta JA}$	71.4	$^{\circ}C/W$
Lead Temperature for Soldering	$T_L$	260	$^{\circ}C$

2. These ratings are applicable when surface mounted on the minimum pad sizes recommended.

**ELECTRICAL CHARACTERISTICS**

( $T_A = 25^{\circ}C$ , common for NPN and PNP, minus sign, “-”, for PNP omitted, unless otherwise noted)

Characteristic	Symbol	Min	Typ	Max	Unit
----------------	--------	-----	-----	-----	------

**OFF CHARACTERISTICS**

Collector-Emitter Sustaining Voltage ( $I_C = 30\text{ mA}$ , $I_B = 0$ )	$V_{CE(sus)}$	80	-	-	Vdc
Collector Cutoff Current ( $V_{CE} = \text{Rated } V_{CE0}$ , $V_{BE} = 0$ )	$I_{CES}$	-	-	1.0	$\mu A$
Emitter Cutoff Current ( $V_{EB} = 5\text{ Vdc}$ )	$I_{EBO}$	-	-	1.0	$\mu A$

**ON CHARACTERISTICS**

Collector-Emitter Saturation Voltage ( $I_C = 8\text{ Adc}$ , $I_B = 0.4\text{ Adc}$ )	$V_{CE(sat)}$	-	-	1	Vdc
Base-Emitter Saturation Voltage ( $I_C = 8\text{ Adc}$ , $I_B = 0.8\text{ Adc}$ )	$V_{BE(sat)}$	-	-	1.5	Vdc
DC Current Gain ( $V_{CE} = 1\text{ Vdc}$ , $I_C = 2\text{ Adc}$ ) ( $V_{CE} = 1\text{ Vdc}$ , $I_C = 4\text{ Adc}$ )	$h_{FE}$	60 40	- -	- -	-

**DYNAMIC CHARACTERISTICS**

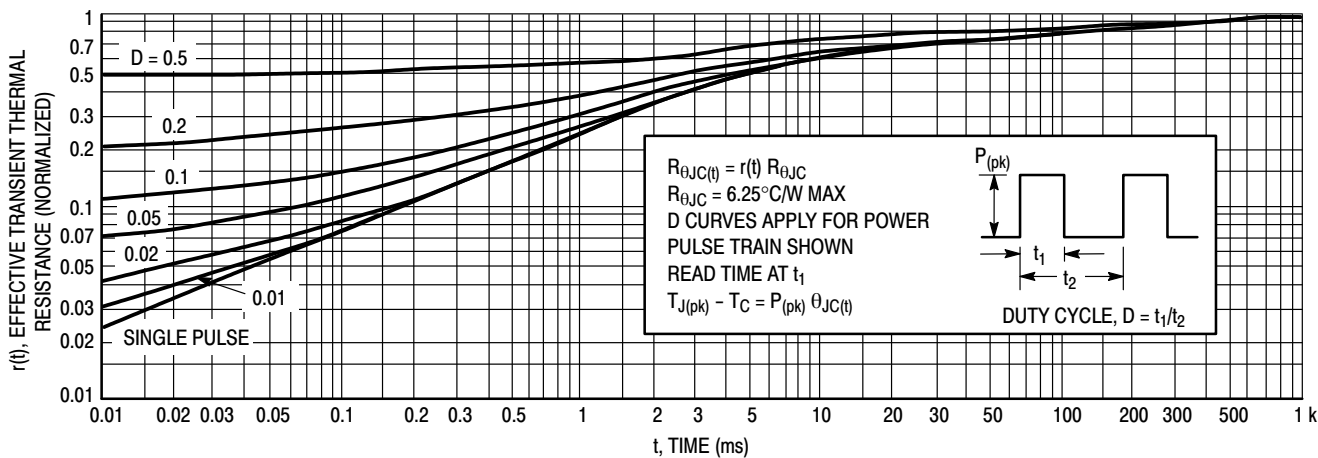
Collector Capacitance ( $V_{CB} = 10\text{ Vdc}$ , $f_{test} = 1\text{ Mhz}$ ) MJD44H11 MJD45H11	$C_{cb}$	- -	45 130	- -	pF
Gain Bandwidth Product ( $I_C = 0.5\text{ Adc}$ , $V_{CE} = 10\text{ Vdc}$ , $f = 20\text{ Mhz}$ ) MJD44H11 MJD45H11	$f_T$	- -	85 90	- -	MHz

**SWITCHING TIMES**

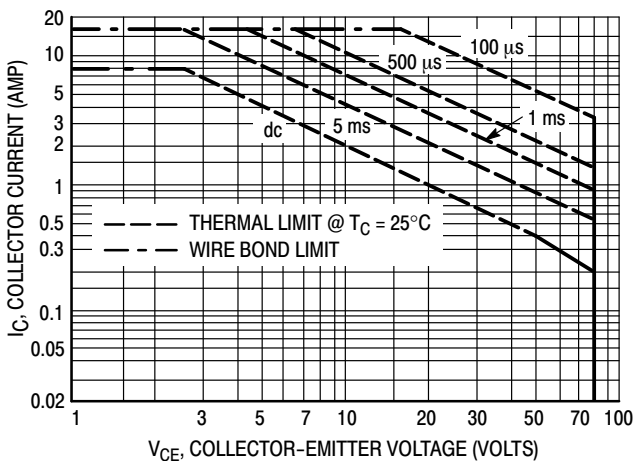
Delay and Rise Times ( $I_C = 5\text{ Adc}$ , $I_{B1} = 0.5\text{ Adc}$ ) MJD44H11 MJD45H11	$t_d + t_r$	- -	300 135	- -	ns
Storage Time ( $I_C = 5\text{ Adc}$ , $I_{B1} = I_{B2} = 0.5\text{ Adc}$ ) MJD44H11 MJD45H11	$t_s$	- -	500 500	- -	ns
Fall Time ( $I_C = 5\text{ Adc}$ , $I_{B1} = I_{B2} = 0.5\text{ Adc}$ ) MJD44H11 MJD45H11	$t_f$	- -	140 100	- -	ns

Product parametric performance is indicated in the Electrical Characteristics for the listed test conditions, unless otherwise noted. Product performance may not be indicated by the Electrical Characteristics if operated under different conditions.

**MJD44H11 (NPN), MJD45H11 (PNP)**



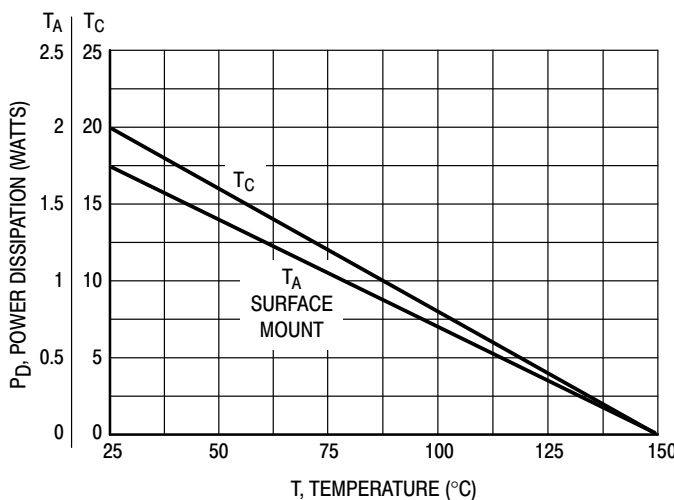
**Figure 1. Thermal Response**



**Figure 2. Maximum Forward Bias Safe Operating Area**

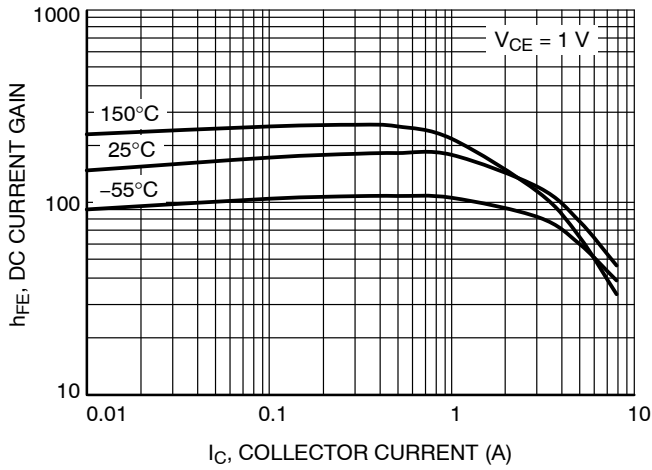
There are two limitations on the power handling ability of a transistor: average junction temperature and second breakdown. Safe operating area curves indicate  $I_C - V_{CE}$  limits of the transistor that must be observed for reliable operation; i.e., the transistor must not be subjected to greater dissipation than the curves indicate.

The data of Figure 2 is based on  $T_{J(pk)} = 150^\circ\text{C}$ ;  $T_C$  is variable depending on conditions. Second breakdown pulse limits are valid for duty cycles to 10% provided  $T_{J(pk)} \leq 150^\circ\text{C}$ .  $T_{J(pk)}$  may be calculated from the data in Figure 1. At high case temperatures, thermal limitations will reduce the power that can be handled to values less than the limitations imposed by second breakdown.

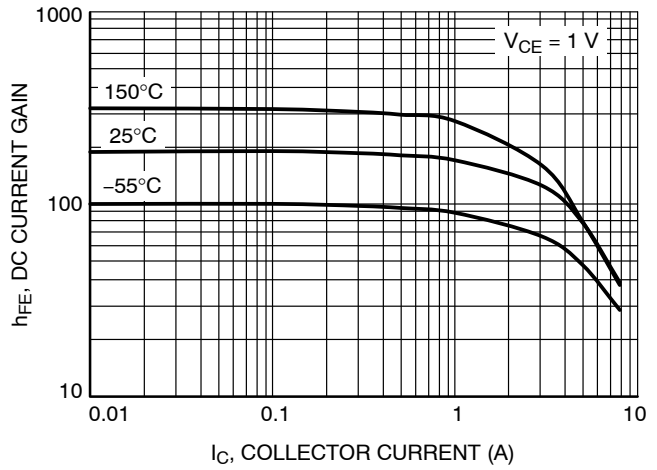


**Figure 3. Power Derating**

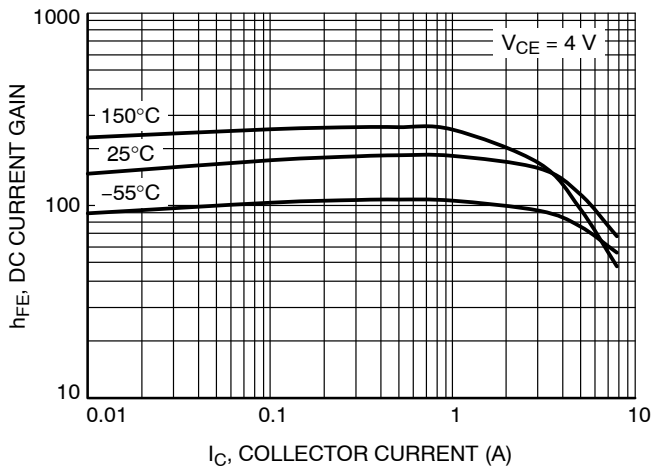
**MJD44H11 (NPN), MJD45H11 (PNP)**



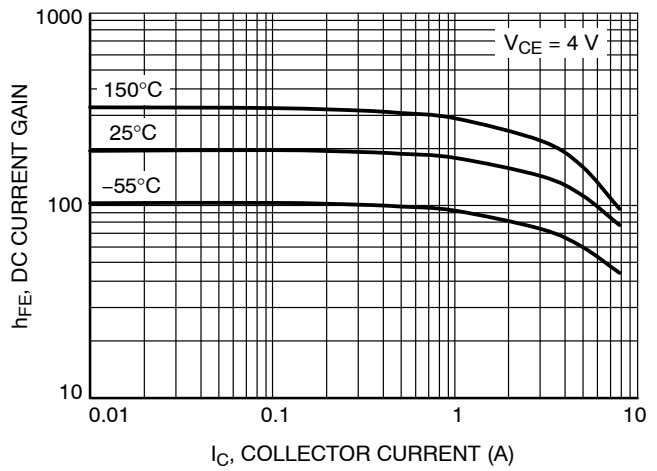
**Figure 4. MJD44H11 DC Current Gain**



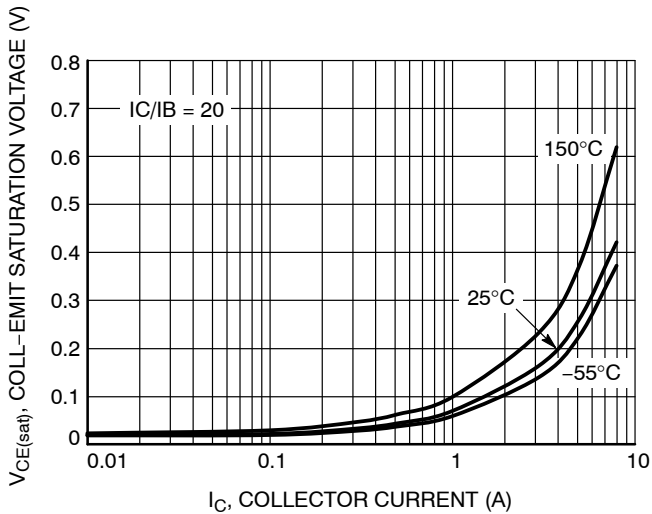
**Figure 5. MJD45H11 DC Current Gain**



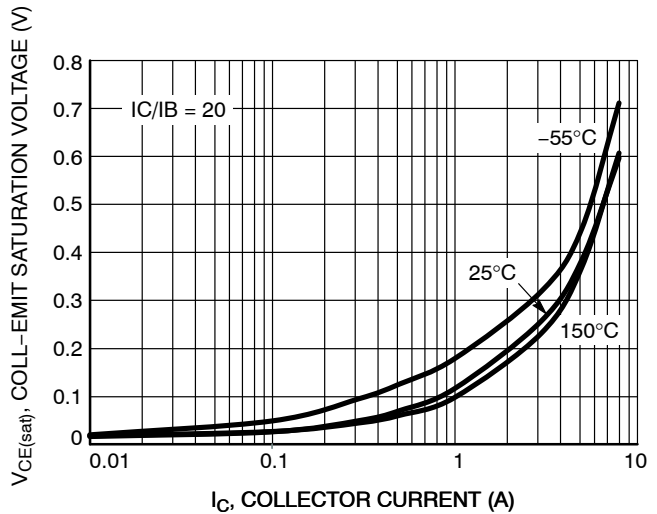
**Figure 6. MJD44H11 DC Current Gain**



**Figure 7. MJD45H11 DC Current Gain**

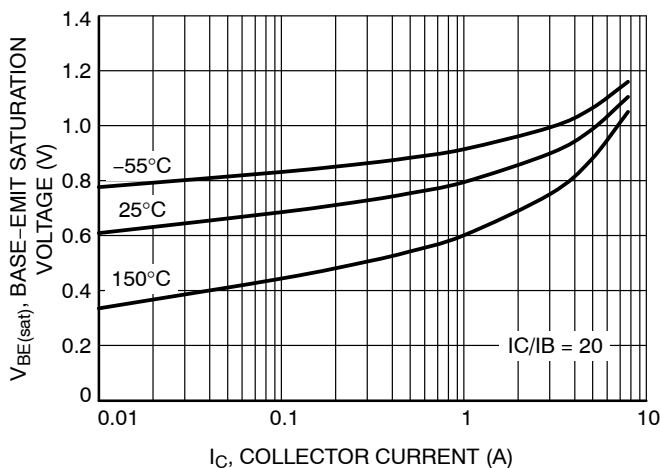


**Figure 8. MJD44H11 Saturation Voltage**  
 $V_{CE(sat)}$

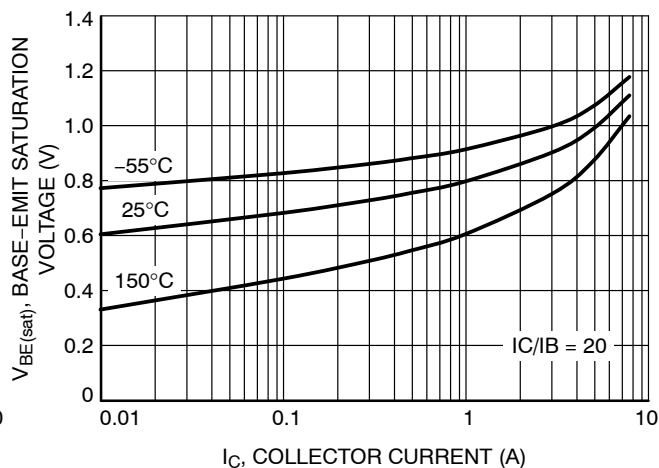


**Figure 9. MJD45H11 Saturation Voltage**  
 $V_{CE(sat)}$

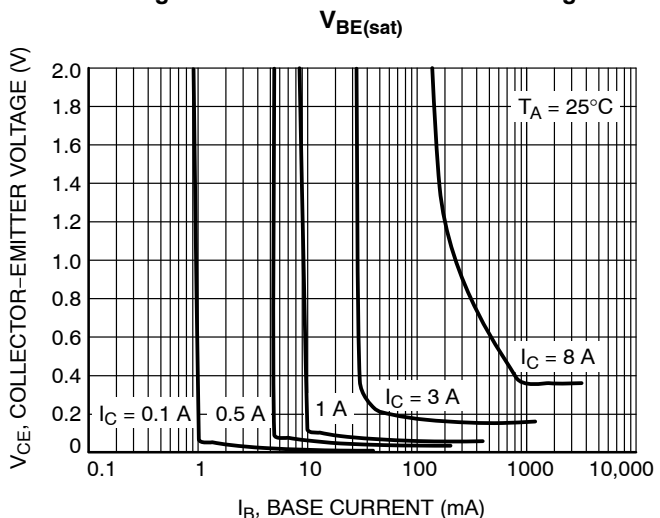
**MJD44H11 (NPN), MJD45H11 (PNP)**



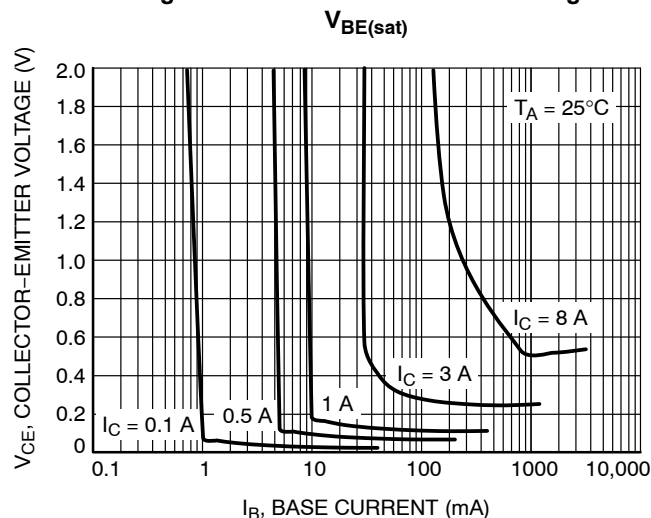
**Figure 10. MJD44H11 Saturation Voltage**



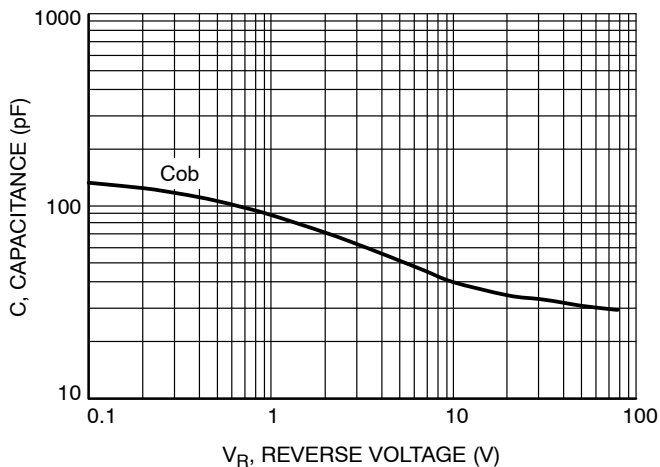
**Figure 11. MJD45H11 Saturation Voltage**



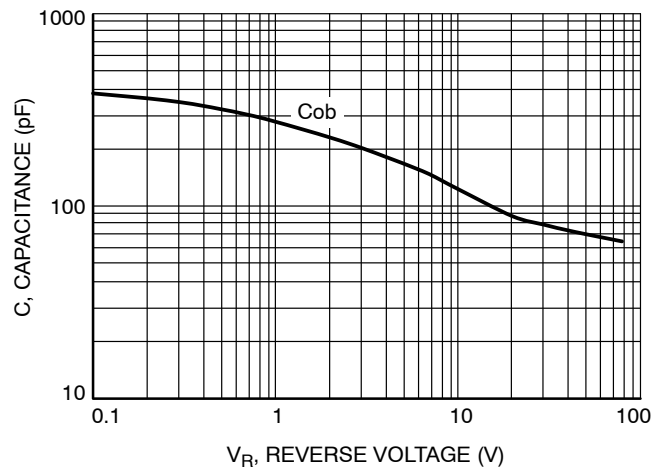
**Figure 12. MJD44H11 Collector Saturation Region**



**Figure 13. MJD45H11 Collector Saturation Region**

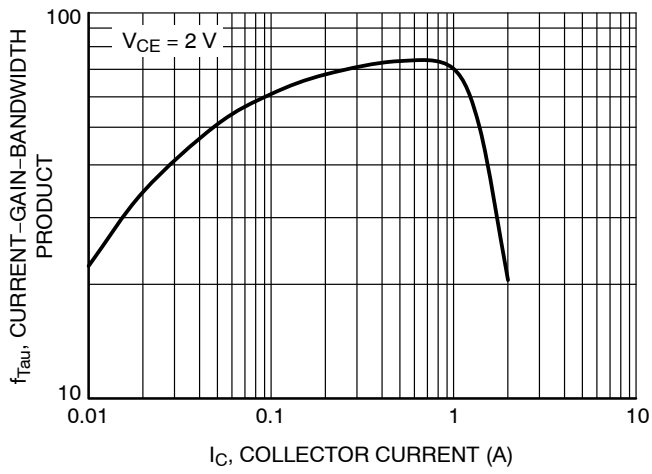


**Figure 14. MJD44H11 Capacitance**

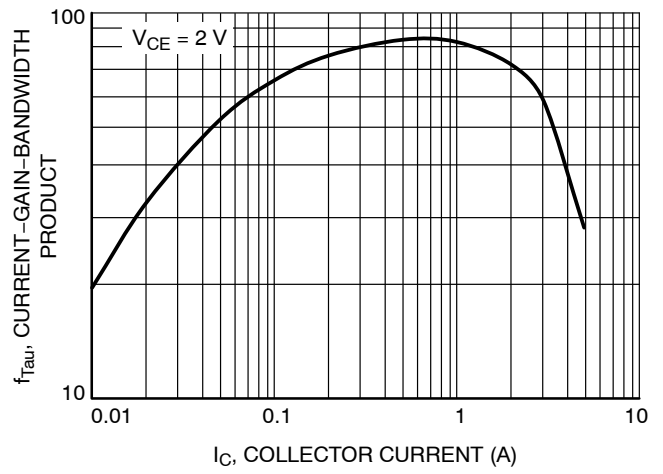


**Figure 15. MJD45H11 Capacitance**

### MJD44H11 (NPN), MJD45H11 (PNP)



**Figure 16. MJD44H11  
Current-Gain-Bandwidth Product**



**Figure 17. MJD45H11  
Current-Gain-Bandwidth Product**



**MJD44H11 (NPN), MJD45H11 (PNP)****ORDERING INFORMATION**

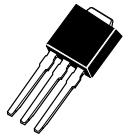
Device	Package Type	Package	Shipping <sup>†</sup>
MJD44H11G	DPAK (Pb-Free)	369C	75 Units / Rail
NJVMJD44H11G	DPAK (Pb-Free)	369C	75 Units / Rail
MJD44H11-1G	DPAK-3 (Pb-Free)	369D	75 Units / Rail
MJD44H11RLG	DPAK (Pb-Free)	369C	1,800 / Tape & Reel
NJVMJD44H11RLG*	DPAK (Pb-Free)	369C	1,800 / Tape & Reel
MJD44H11T4G	DPAK (Pb-Free)	369C	2,500 / Tape & Reel
NJVMJD44H11T4G*	DPAK (Pb-Free)	369C	2,500 / Tape & Reel
MJD44H11T5G	DPAK (Pb-Free)	369C	2,500 / Tape & Reel
MJD45H11G	DPAK (Pb-Free)	369C	75 Units / Rail
NJVMJD45H11G*	DPAK (Pb-Free)	369C	75 Units / Rail
MJD45H11-1G	DPAK-3 (Pb-Free)	369D	75 Units / Rail
MJD45H11RLG	DPAK (Pb-Free)	369C	1,800 / Tape & Reel
NJVMJD45H11RLG*	DPAK (Pb-Free)	369C	1,800 / Tape & Reel
MJD45H11T4G	DPAK (Pb-Free)	369C	2,500 / Tape & Reel
NJVMJD45H11T4G*	DPAK (Pb-Free)	369C	2,500 / Tape & Reel
NJVMJD44H11D3T4G*	DPAK (Pb-Free)	369G	2,500 / Tape & Reel
NJVMJD45H11D3T4G*	DPAK (Pb-Free)	369G	2,500 / Tape & Reel

<sup>†</sup>For information on tape and reel specifications, including part orientation and tape sizes, please refer to our Tape and Reel Packaging Specifications Brochure, BRD8011/D.

\*NJV Prefix for Automotive and Other Applications Requiring Unique Site and Control Change Requirements; AEC-Q101 Qualified and PPAP Capable



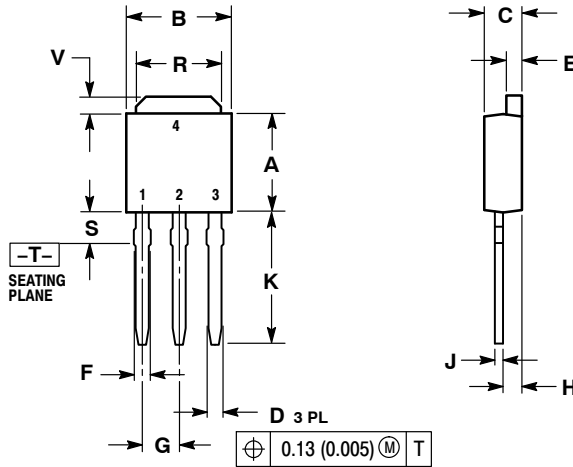
**MECHANICAL CASE OUTLINE  
PACKAGE DIMENSIONS**



**DPAK INSERTION MOUNT  
CASE 369  
ISSUE O**

DATE 02 JAN 2000

SCALE 1:1



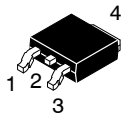
- NOTES:  
1. DIMENSIONING AND TOLERANCING PER ANSI Y14.5M, 1982.  
2. CONTROLLING DIMENSION: INCH.

DIM	INCHES		MILLIMETERS	
	MIN	MAX	MIN	MAX
A	0.235	0.250	5.97	6.35
B	0.250	0.265	6.35	6.73
C	0.086	0.094	2.19	2.38
D	0.027	0.035	0.69	0.88
E	0.033	0.040	0.84	1.01
F	0.037	0.047	0.94	1.19
G	0.090 BSC		2.29 BSC	
H	0.034	0.040	0.87	1.01
J	0.018	0.023	0.46	0.58
K	0.350	0.380	8.89	9.65
R	0.175	0.215	4.45	5.46
S	0.050	0.090	1.27	2.28
V	0.030	0.050	0.77	1.27

- |  |   |   |  |  |  |
|--|---|---|--|--|--|
| <p>STYLE 1:<br/>PIN 1. BASE<br/>2. COLLECTOR<br/>3. EMITTER<br/>4. COLLECTOR</p> | <p>STYLE 2:<br/>PIN 1. GATE<br/>2. DRAIN<br/>3. SOURCE<br/>4. DRAIN</p> | <p>STYLE 3:<br/>PIN 1. ANODE<br/>2. CATHODE<br/>3. ANODE<br/>4. CATHODE</p> | <p>STYLE 4:<br/>PIN 1. CATHODE<br/>2. ANODE<br/>3. GATE<br/>4. ANODE</p> | <p>STYLE 5:<br/>PIN 1. GATE<br/>2. ANODE<br/>3. CATHODE<br/>4. ANODE</p> | <p>STYLE 6:<br/>PIN 1. MT1<br/>2. MT2<br/>3. GATE<br/>4. MT2</p> |
|--|---|---|--|--|--|

<b>DOCUMENT NUMBER:</b>	<b>98ASB42319B</b>	Electronic versions are uncontrolled except when accessed directly from the Document Repository. Printed versions are uncontrolled except when stamped "CONTROLLED COPY" in red.
<b>DESCRIPTION:</b>	<b>DPAK INSERTION MOUNT</b>	<b>PAGE 1 OF 1</b>

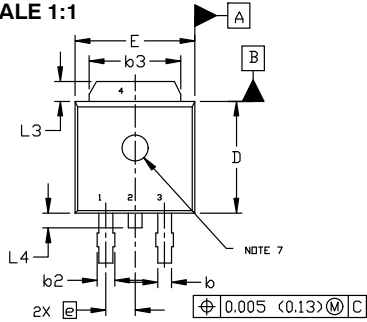
onsemi and ONSEMI are trademarks of Semiconductor Components Industries, LLC dba onsemi or its subsidiaries in the United States and/or other countries. onsemi reserves the right to make changes without further notice to any products herein. onsemi makes no warranty, representation or guarantee regarding the suitability of its products for any particular purpose, nor does onsemi assume any liability arising out of the application or use of any product or circuit, and specifically disclaims any and all liability, including without limitation special, consequential or incidental damages. onsemi does not convey any license under its patent rights nor the rights of others.



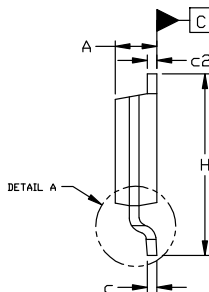
**DPAK (SINGLE GAUGE)  
CASE 369C  
ISSUE G**

DATE 31 MAY 2023

SCALE 1:1



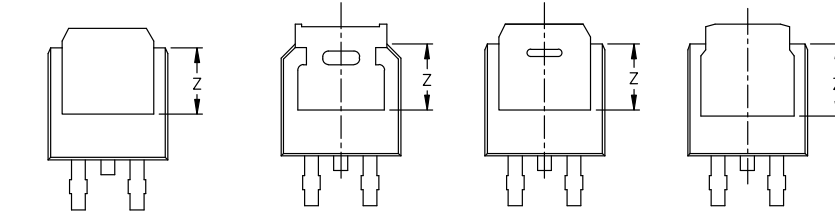
TOP VIEW



SIDE VIEW

NOTES:

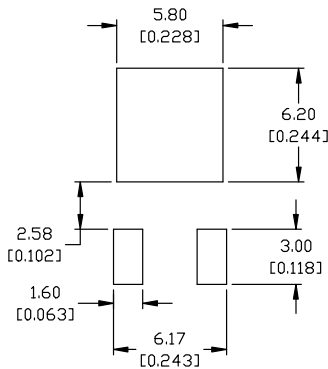
1. DIMENSIONING AND TOLERANCING ASME Y14.5M, 1994.
2. CONTROLLING DIMENSION: INCHES
3. THERMAL PAD CONTOUR OPTIONAL WITHIN DIMENSIONS b3, L3, AND Z.
4. DIMENSIONS D AND E DO NOT INCLUDE MOLD FLASH, PROTRUSIONS, OR BURRS. MOLD FLASH, PROTRUSIONS, OR GATE BURRS SHALL NOT EXCEED 0.006 INCHES PER SIDE.
5. DIMENSIONS D AND E ARE DETERMINED AT THE OUTERMOST EXTREMES OF THE PLASTIC BODY.
6. DATUMS A AND B ARE DETERMINED AT DATUM PLANE H.
7. OPTIONAL MOLD FEATURE.



BOTTOM VIEW

BOTTOM VIEW

ALTERNATE CONSTRUCTIONS

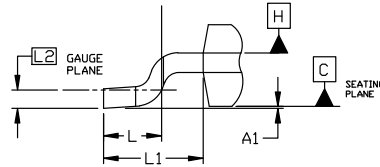


**RECOMMENDED MOUNTING FOOTPRINT\***

\*FOR ADDITIONAL INFORMATION ON OUR Pb-FREE STRATEGY AND SOLDERING DETAILS, PLEASE DOWNLOAD THE ON SEMICONDUCTOR SOLDERING AND MOUNTING TECHNIQUES REFERENCE MANUAL, SOLDERM/D.

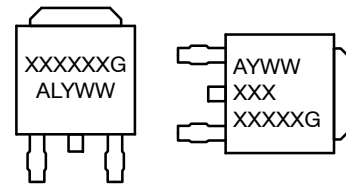
- |   |   |  |  |   |
|---|---|--|--|---|
| STYLE 1:<br>PIN 1. BASE<br>2. COLLECTOR<br>3. EMITTER<br>4. COLLECTOR | STYLE 2:<br>PIN 1. GATE<br>2. DRAIN<br>3. SOURCE<br>4. DRAIN          | STYLE 3:<br>PIN 1. ANODE<br>2. CATHODE<br>3. ANODE<br>4. CATHODE | STYLE 4:<br>PIN 1. CATHODE<br>2. ANODE<br>3. GATE<br>4. ANODE              | STYLE 5:<br>PIN 1. GATE<br>2. ANODE<br>3. CATHODE<br>4. ANODE     |
| STYLE 6:<br>PIN 1. MT1<br>2. MT2<br>3. GATE<br>4. MT2                 | STYLE 7:<br>PIN 1. GATE<br>2. COLLECTOR<br>3. EMITTER<br>4. COLLECTOR | STYLE 8:<br>PIN 1. N/C<br>2. CATHODE<br>3. ANODE<br>4. CATHODE   | STYLE 9:<br>PIN 1. ANODE<br>2. CATHODE<br>3. RESISTOR ADJUST<br>4. CATHODE | STYLE 10:<br>PIN 1. CATHODE<br>2. ANODE<br>3. CATHODE<br>4. ANODE |

DIM	INCHES		MILLIMETERS	
	MIN.	MAX.	MIN.	MAX.
A	0.086	0.094	2.18	2.38
A1	0.000	0.005	0.00	0.13
b	0.025	0.035	0.63	0.89
b2	0.028	0.045	0.72	1.14
b3	0.180	0.215	4.57	5.46
c	0.018	0.024	0.46	0.61
c2	0.018	0.024	0.46	0.61
D	0.235	0.245	5.97	6.22
E	0.250	0.265	6.35	6.73
e	0.090	BSC	2.29	BSC
H	0.370	0.410	9.40	10.41
L	0.055	0.070	1.40	1.78
L1	0.114	REF	2.90	REF
L2	0.020	BSC	0.51	BSC
L3	0.035	0.050	0.89	1.27
L4	---	0.040	---	1.01
Z	0.155	---	3.93	---



DETAIL A  
ROTATED 90° CW

**GENERIC MARKING DIAGRAM\***



IC

Discrete

- XXXXXX = Device Code  
 A = Assembly Location  
 L = Wafer Lot  
 Y = Year  
 WW = Work Week  
 G = Pb-Free Package

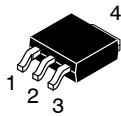
\*This information is generic. Please refer to device data sheet for actual part marking. Pb-Free indicator, "G" or microdot "•", may or may not be present. Some products may not follow the Generic Marking.

<b>DOCUMENT NUMBER:</b>	<b>98AON10527D</b>	Electronic versions are uncontrolled except when accessed directly from the Document Repository. Printed versions are uncontrolled except when stamped "CONTROLLED COPY" in red.
<b>DESCRIPTION:</b>	<b>DPAK (SINGLE GAUGE)</b>	<b>PAGE 1 OF 1</b>

onsemi and Onsemi are trademarks of Semiconductor Components Industries, LLC dba onsemi or its subsidiaries in the United States and/or other countries. onsemi reserves the right to make changes without further notice to any products herein. onsemi makes no warranty, representation or guarantee regarding the suitability of its products for any particular purpose, nor does onsemi assume any liability arising out of the application or use of any product or circuit, and specifically disclaims any and all liability, including without limitation special, consequential or incidental damages. onsemi does not convey any license under its patent rights nor the rights of others.



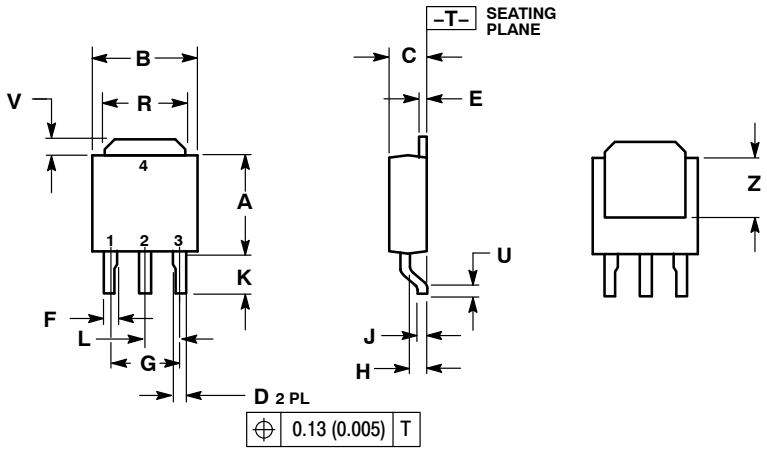
**MECHANICAL CASE OUTLINE  
PACKAGE DIMENSIONS**



SCALE 1:1

**DPAK-3, SURFACE MOUNT  
CASE 369G  
ISSUE O**

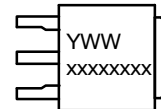
DATE 23 DEC 2003



- NOTES:  
1. DIMENSIONING AND TOLERANCING PER ANSI Y14.5M, 1982.  
2. CONTROLLING DIMENSION: INCH.

DIM	INCHES		MILLIMETERS	
	MIN	MAX	MIN	MAX
A	0.235	0.245	5.97	6.22
B	0.250	0.265	6.35	6.73
C	0.086	0.094	2.19	2.38
D	0.027	0.035	0.69	0.88
E	0.018	0.023	0.46	0.58
F	0.037	0.045	0.94	1.14
G	0.180 BSC		4.58 BSC	
H	0.034	0.040	0.87	1.01
J	0.018	0.023	0.46	0.58
K	0.102	0.114	2.60	2.89
L	0.090 BSC		2.29 BSC	
R	0.180	0.215	4.57	5.45
U	0.020	----	0.51	----
V	0.035	0.050	0.89	1.27
Z	0.155	----	3.93	----

**GENERIC  
MARKING DIAGRAM\***



xxxxxxxx = Device Code  
Y = Year  
WW = Work Week

- |  |   |  |  |
|--|---|--|--|
| <p>STYLE 1:<br/>PIN 1. BASE<br/>2. COLLECTOR<br/>3. EMITTER<br/>4. COLLECTOR</p> | <p>STYLE 2:<br/>PIN 1. GATE<br/>2. DRAIN<br/>3. SOURCE<br/>4. DRAIN</p> | <p>STYLE 3:<br/>PIN 1. ANODE<br/>2. CATHODE<br/>3. ANODE<br/>4. CATHODE</p>      | <p>STYLE 4:<br/>PIN 1. CATHODE<br/>2. ANODE<br/>3. GATE<br/>4. ANODE</p> |
| <p>STYLE 5:<br/>PIN 1. GATE<br/>2. ANODE<br/>3. CATHODE<br/>4. ANODE</p>         | <p>STYLE 6:<br/>PIN 1. MT1<br/>2. MT2<br/>3. GATE<br/>4. MT2</p>        | <p>STYLE 7:<br/>PIN 1. GATE<br/>2. COLLECTOR<br/>3. EMITTER<br/>4. COLLECTOR</p> |  |

\*This information is generic. Please refer to device data sheet for actual part marking.

<b>DOCUMENT NUMBER:</b>	<b>98AON13702D</b>	Electronic versions are uncontrolled except when accessed directly from the Document Repository. Printed versions are uncontrolled except when stamped "CONTROLLED COPY" in red.
<b>DESCRIPTION:</b>	<b>DPAK-3, SURFACE MOUNT</b>	<b>PAGE 1 OF 1</b>

onsemi and ONSEMI are trademarks of Semiconductor Components Industries, LLC dba onsemi or its subsidiaries in the United States and/or other countries. onsemi reserves the right to make changes without further notice to any products herein. onsemi makes no warranty, representation or guarantee regarding the suitability of its products for any particular purpose, nor does onsemi assume any liability arising out of the application or use of any product or circuit, and specifically disclaims any and all liability, including without limitation special, consequential or incidental damages. onsemi does not convey any license under its patent rights nor the rights of others.

**onsemi**, **Onsemi**, and other names, marks, and brands are registered and/or common law trademarks of Semiconductor Components Industries, LLC dba "**onsemi**" or its affiliates and/or subsidiaries in the United States and/or other countries. **onsemi** owns the rights to a number of patents, trademarks, copyrights, trade secrets, and other intellectual property. A listing of **onsemi**'s product/patent coverage may be accessed at [www.onsemi.com/site/pdf/Patent-Marking.pdf](http://www.onsemi.com/site/pdf/Patent-Marking.pdf). **onsemi** reserves the right to make changes at any time to any products or information herein, without notice. The information herein is provided "as-is" and **onsemi** makes no warranty, representation or guarantee regarding the accuracy of the information, product features, availability, functionality, or suitability of its products for any particular purpose, nor does **onsemi** assume any liability arising out of the application or use of any product or circuit, and specifically disclaims any and all liability, including without limitation special, consequential or incidental damages. Buyer is responsible for its products and applications using **onsemi** products, including compliance with all laws, regulations and safety requirements or standards, regardless of any support or applications information provided by **onsemi**. "Typical" parameters which may be provided in **onsemi** data sheets and/or specifications can and do vary in different applications and actual performance may vary over time. All operating parameters, including "Typicals" must be validated for each customer application by customer's technical experts. **onsemi** does not convey any license under any of its intellectual property rights nor the rights of others. **onsemi** products are not designed, intended, or authorized for use as a critical component in life support systems or any FDA Class 3 medical devices or medical devices with a same or similar classification in a foreign jurisdiction or any devices intended for implantation in the human body. Should Buyer purchase or use **onsemi** products for any such unintended or unauthorized application, Buyer shall indemnify and hold **onsemi** and its officers, employees, subsidiaries, affiliates, and distributors harmless against all claims, costs, damages, and expenses, and reasonable attorney fees arising out of, directly or indirectly, any claim of personal injury or death associated with such unintended or unauthorized use, even if such claim alleges that **onsemi** was negligent regarding the design or manufacture of the part. **onsemi** is an Equal Opportunity/Affirmative Action Employer. This literature is subject to all applicable copyright laws and is not for resale in any manner.

#### ADDITIONAL INFORMATION

**TECHNICAL PUBLICATIONS:**

Technical Library: [www.onsemi.com/design/resources/technical-documentation](http://www.onsemi.com/design/resources/technical-documentation)  
onsemi Website: [www.onsemi.com](http://www.onsemi.com)

**ONLINE SUPPORT:** [www.onsemi.com/support](http://www.onsemi.com/support)

For additional information, please contact your local Sales Representative at [www.onsemi.com/support/sales](http://www.onsemi.com/support/sales)



## OUR CERTIFICATE

DiGi provide top-quality products and perfect service for customer worldwide through standardization, technological innovation and continuous improvement. DiGi through third-party certification, we stricly control the quality of products and services. Welcome your RFQ to

Email: [Info@DiGi-Electronics.com](mailto:Info@DiGi-Electronics.com)



Tel: +00 852-30501935

RFQ Email: [Info@DiGi-Electronics.com](mailto:Info@DiGi-Electronics.com)

DiGi is a global authorized distributor of electronic components.