

MJE18008G Datasheet

www.digi-electronics.com

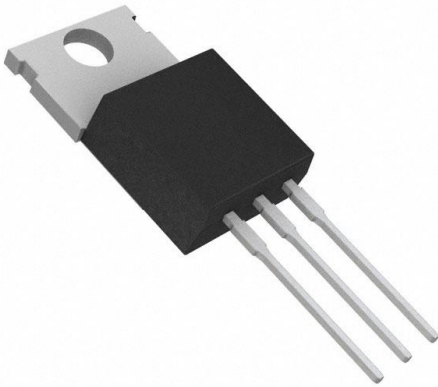

<https://www.DiGi-Electronics.com>

DiGi Electronics Part Number	MJE18008G-DG
Manufacturer	onsemi
Manufacturer Product Number	MJE18008G
Description	TRANS NPN 450V 8A TO220
Detailed Description	Bipolar (BJT) Transistor NPN 450 V 8 A 13MHz 125 W Through Hole TO-220



Tel: +00 852-30501935

RFQ Email: Info@DiGi-Electronics.com

DiGi is a global authorized distributor of electronic components.

Purchase and inquiry

Manufacturer Product Number:

MJE18008G

Series:

SWITCHMODE™

Transistor Type:

NPN

Voltage - Collector Emitter Breakdown (Max):

450 V

Current - Collector Cutoff (Max):

100µA

Power - Max:

125 W

Operating Temperature:

-65°C ~ 150°C (TJ)

Package / Case:

TO-220-3

Base Product Number:

MJE18008

Manufacturer:

onsemi

Product Status:

Active

Current - Collector (Ic) (Max):

8 A

Vce Saturation (Max) @ Ib, Ic:

700mV @ 900mA, 4.5V

DC Current Gain (hFE) (Min) @ Ic, Vce:

14 @ 1A, 5V

Frequency - Transition:

13MHz

Mounting Type:

Through Hole

Supplier Device Package:

TO-220

Environmental & Export classification

RoHS Status:

ROHS3 Compliant

REACH Status:

REACH Unaffected

HTSUS:

8541.29.0095

Moisture Sensitivity Level (MSL):

Not Applicable

ECCN:

EAR99

Switch-mode NPN Bipolar Power Transistor

For Switching Power Supply Applications

MJE18008

The MJE18008 have an applications specific state-of-the-art die designed for use in 220 V line-operated switch-mode Power supplies and electronic light ballasts.

Features

- Improved Efficiency Due to Low Base Drive Requirements:
 - High and Flat DC Current Gain h_{FE}
 - Fast Switching
 - No Coil Required in Base Circuit for Turn-Off (No Current Tail)
- Tight Parametric Distributions are Consistent Lot-to-Lot
- Two Package Choices: Standard TO-220 or Isolated TO-220
- These Devices are Pb-Free and are RoHS Compliant*

MAXIMUM RATINGS

Rating	Symbol	Value	Unit
Collector-Emitter Sustaining Voltage	V_{CEO}	450	Vdc
Collector-Base Breakdown Voltage	V_{CES}	1000	Vdc
Emitter-Base Voltage	V_{EBO}	9.0	Vdc
Collector Current – Continuous	I_C	8.0	Adc
Collector Current – Peak (Note 1)	I_{CM}	16	Adc
Base Current – Continuous	I_B	4.0	Adc
Base Current – Peak (Note 1)	I_{BM}	8.0	Adc
RMS Isolation Voltage (Note 2) Test No. 1 Per Figure 22a Test No. 1 Per Figure 22b Test No. 1 Per Figure 22c (for 1 sec, R.H. < 30%, $T_A = 25^\circ\text{C}$)	V_{ISOL}	4500 3500 1500	V
Total Device Dissipation @ $T_C = 25^\circ\text{C}$ Derate above 25°C	P_D	125 1.0	W W/ $^\circ\text{C}$
Operating and Storage Temperature	T_J, T_{stg}	-65 to 150	$^\circ\text{C}$

THERMAL CHARACTERISTICS

Characteristics	Symbol	Max	Unit
Thermal Resistance, Junction-to-Case	$R_{\theta JC}$	1.0	$^\circ\text{C}/\text{W}$
Thermal Resistance, Junction-to-Ambient	$R_{\theta JA}$	62.5	$^\circ\text{C}/\text{W}$
Maximum Lead Temperature for Soldering Purposes 1/8" from Case for 5 Seconds	T_L	260	$^\circ\text{C}$

Stresses exceeding those listed in the Maximum Ratings table may damage the device. If any of these limits are exceeded, device functionality should not be assumed, damage may occur and reliability may be affected.

- Pulse Test: Pulse Width = 5 ms, Duty Cycle $\leq 10\%$.
- Proper strike and creepage distance must be provided.

POWER TRANSISTOR
8.0 AMPERES
1000 VOLTS
45 and 125 WATTS

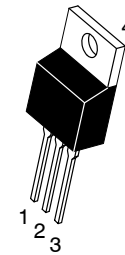
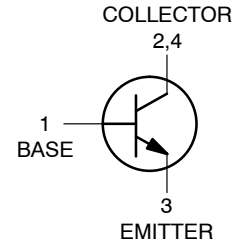

TO-220AB
CASE 221A-09
STYLE 1

MARKING DIAGRAM

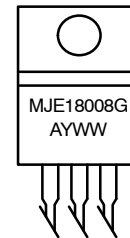

G = Pb-Free Package
 A = Assembly Location
 Y = Year
 WW = Work Week

ORDERING INFORMATION

Device	Package	Shipping
MJE18008G	TO-220AB (Pb-Free)	50 Units / Rail

*For additional information on our Pb-Free strategy and soldering details, please download the **onsemi** Soldering and Mounting Techniques Reference Manual, SOLDERRM/D.

MJE18008**ELECTRICAL CHARACTERISTICS** ($T_C = 25^\circ\text{C}$ unless otherwise specified)

Characteristic	Symbol	Min	Typ	Max	Unit
----------------	--------	-----	-----	-----	------

OFF CHARACTERISTICS

Collector-Emitter Sustaining Voltage ($I_C = 100\text{ mA}$, $L = 25\text{ mH}$)	$V_{CEO(sus)}$	450	-	-	Vdc
Collector Cutoff Current ($V_{CE} = \text{Rated } V_{CEO}$, $I_B = 0$)	I_{CEO}	-	-	100	μAdc
Collector Cutoff Current ($V_{CE} = \text{Rated } V_{CES}$, $V_{EB} = 0$)	I_{CES}	-	-	100	μAdc
				500	
				100	
Emitter Cutoff Current ($V_{EB} = 9.0\text{ Vdc}$, $I_C = 0$)	I_{EBO}	-	-	100	μAdc

ON CHARACTERISTICS

Base-Emitter Saturation Voltage ($I_C = 2.0\text{ Adc}$, $I_B = 0.2\text{ Adc}$) ($I_C = 4.5\text{ Adc}$, $I_B = 0.9\text{ Adc}$)	$V_{BE(sat)}$	-	0.82 0.92	1.1 1.25	Vdc
Collector-Emitter Saturation Voltage ($I_C = 2.0\text{ Adc}$, $I_B = 0.2\text{ Adc}$)	$V_{CE(sat)}$	-	0.3	0.6	Vdc
			0.3	0.65	
			0.35	0.7	
			0.4	0.8	
DC Current Gain ($I_C = 1.0\text{ Adc}$, $V_{CE} = 5.0\text{ Vdc}$)	h_{FE}	14	-	34	-
		-	28	-	
		6.0	9.0	-	
		5.0	8.0	-	
		11	15	-	
		11	16	-	
		10	20	-	

DYNAMIC CHARACTERISTICS

Current Gain Bandwidth ($I_C = 0.5\text{ Adc}$, $V_{CE} = 10\text{ Vdc}$, $f = 1.0\text{ MHz}$)	f_T	-	13	-	MHz
Output Capacitance ($V_{CB} = 10\text{ Vdc}$, $I_E = 0$, $f = 1.0\text{ MHz}$)	C_{ob}	-	100	150	pF
Input Capacitance ($V_{EB} = 8.0\text{ V}$)	C_{ib}	-	1750	2500	pF
Dynamic Saturation Voltage: Determined 1.0 μs and 3.0 μs respectively after rising I_{B1} reaches 90% of final I_{B1} (see Figure 18)	$V_{CE(dsat)}$				Vdc

SWITCHING CHARACTERISTICS: Resistive Load (D.C. $\leq 10\%$, Pulse Width = 20 μs)

Turn-On Time	$(I_C = 2.0\text{ Adc}$, $I_{B1} = 0.2\text{ Adc}$, $I_{B2} = 1.0\text{ Adc}$, $V_{CC} = 300\text{ V}$)	$(T_C = 125^\circ\text{C})$	t_{on}	-	200	300	ns
Turn-Off Time			t_{off}	-	1.2	2.5	μs
					1.5	-	
Turn-On Time	$(I_C = 4.5\text{ Adc}$, $I_{B1} = 0.9\text{ Adc}$, $I_{B2} = 2.25\text{ Adc}$, $V_{CC} = 300\text{ V}$)	$(T_C = 125^\circ\text{C})$	t_{on}	-	100	180	ns
Turn-Off Time			t_{off}	-	1.6	2.5	μs
					2.0	-	

SWITCHING CHARACTERISTICS: Inductive Load ($V_{clamp} = 300\text{ V}$, $V_{CC} = 15\text{ V}$, $L = 200\text{ }\mu\text{H}$)

Fall Time	$(I_C = 2.0\text{ Adc}$, $I_{B1} = 0.2\text{ Adc}$, $I_{B2} = 1.0\text{ Adc}$)	$(T_C = 125^\circ\text{C})$	t_{fi}	-	100	180	ns
Storage Time			t_{si}	-	1.5	2.75	μs
					1.9	-	
Crossover Time			t_c	-	250	350	ns
					230	-	
Fall Time	$(I_C = 4.5\text{ Adc}$, $I_{B1} = 0.9\text{ Adc}$, $I_{B2} = 2.25\text{ Adc}$)	$(T_C = 125^\circ\text{C})$	t_{fi}	-	85	150	ns
Storage Time			t_{si}	-	2.0	3.2	μs
					2.6	-	
Crossover Time			t_c	-	210	300	ns
					250	-	

- Pulse Test: Pulse Width = 5.0 ms, Duty Cycle $\leq 10\%$.
- Proper strike and creepage distance must be provided.

MJE18008

TYPICAL STATIC CHARACTERISTICS

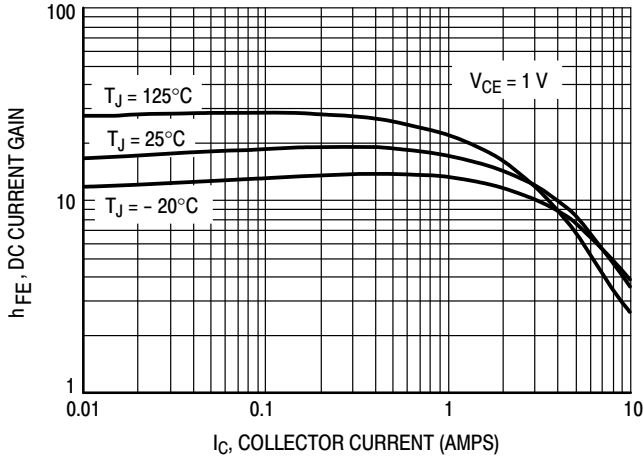

Figure 1. DC Current Gain @ 1 Volt

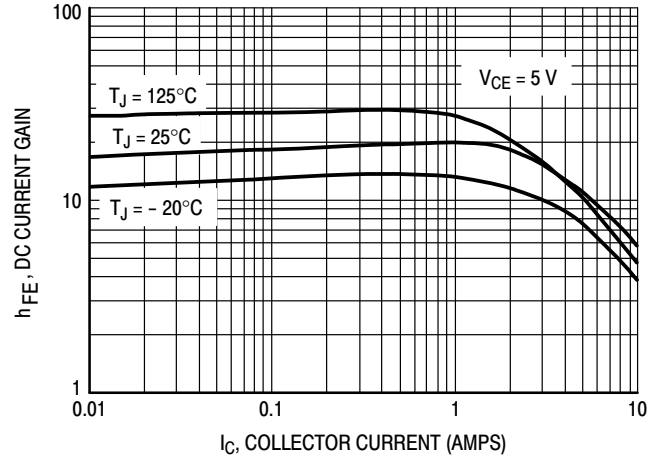

Figure 2. DC Current Gain @ 5 Volts

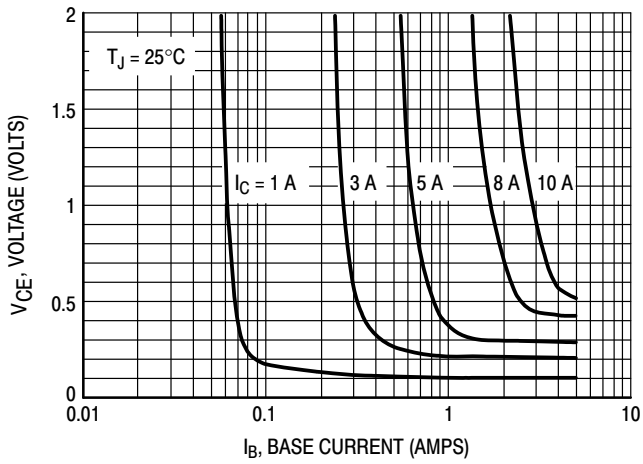

Figure 3. Collector Saturation Region

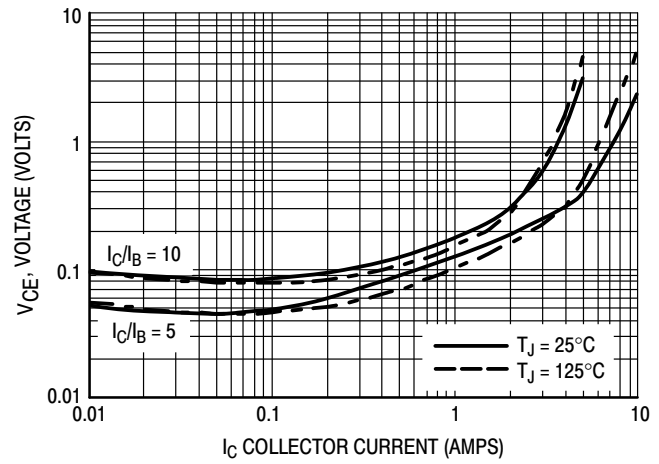

Figure 4. Collector-Emitter Saturation Voltage

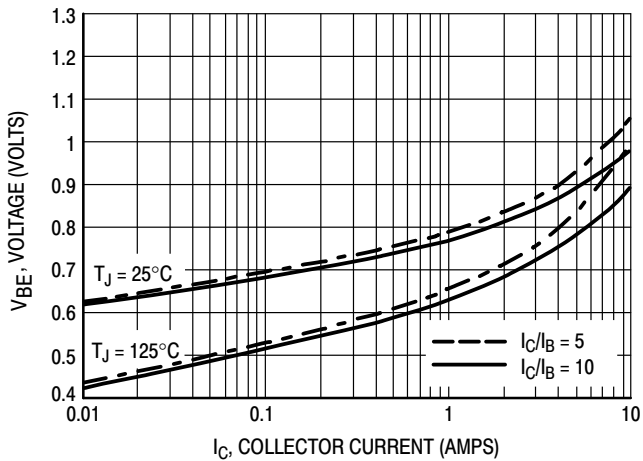

Figure 5. Base-Emitter Saturation Region

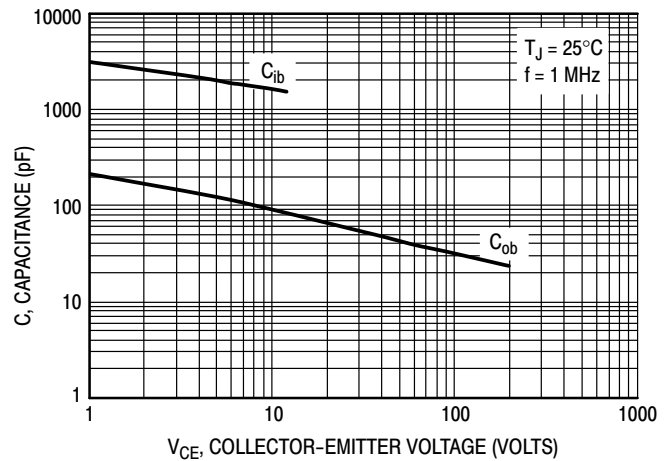

Figure 6. Capacitance

MJE18008

TYPICAL SWITCHING CHARACTERISTICS
($I_{B2} = I_C/2$ FOR ALL SWITCHING) (continued)

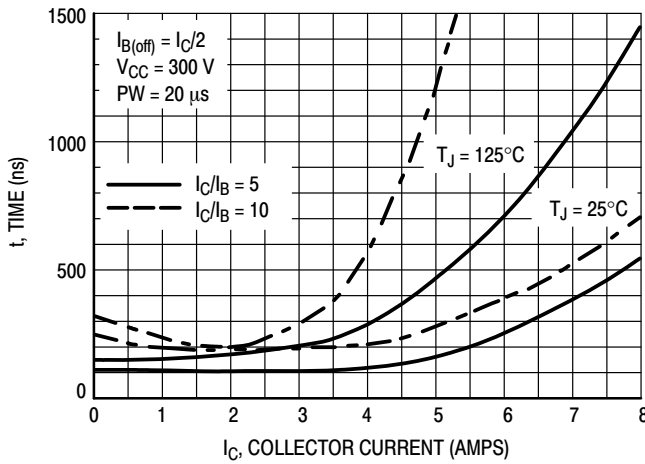

Figure 7. Resistive Switching, t_{on}

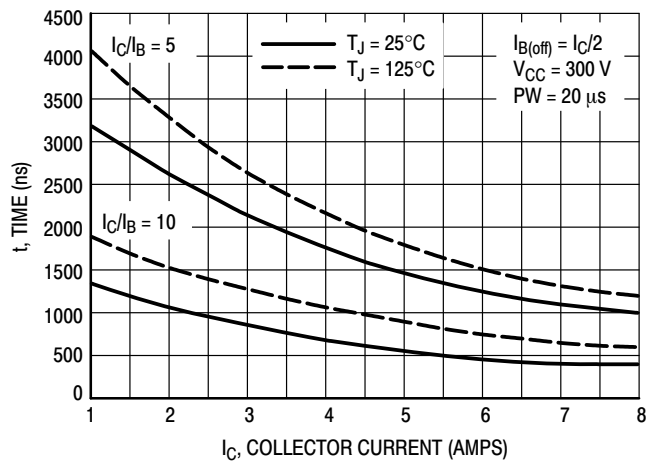

Figure 8. Resistive Switching, t_{off}

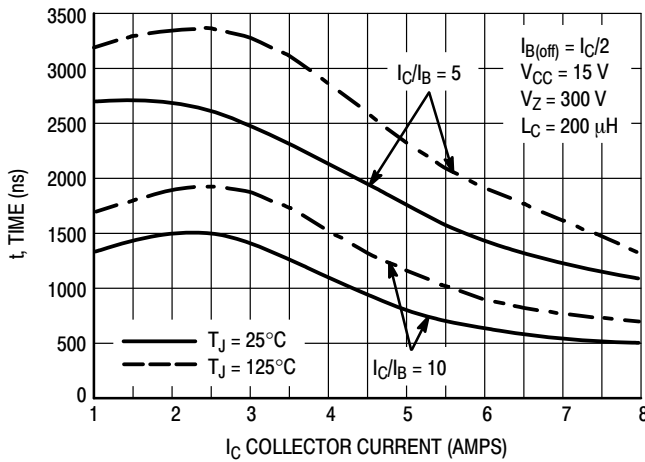

Figure 9. Inductive Storage Time, t_{si}

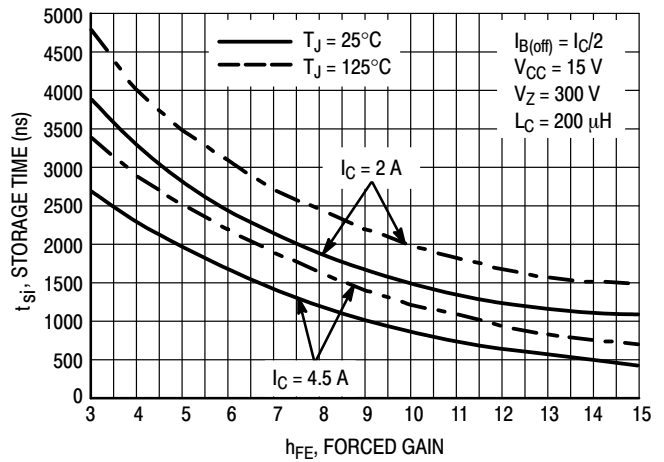

Figure 10. Inductive Storage Time, $t_{si}(h_{FE})$

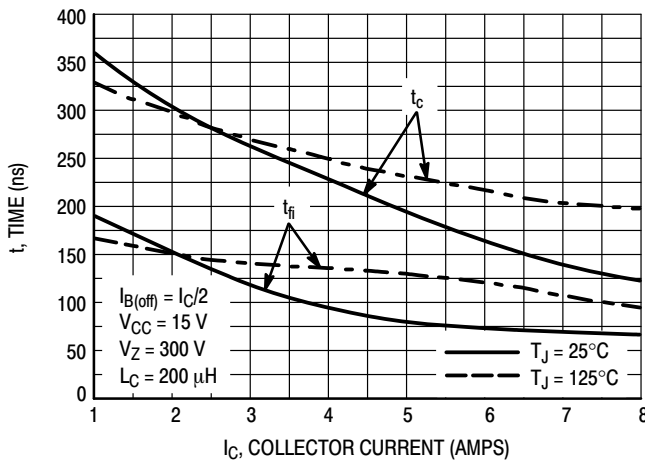

Figure 11. Inductive Switching, t_c and t_{fi}
 $I_C/I_B = 5$

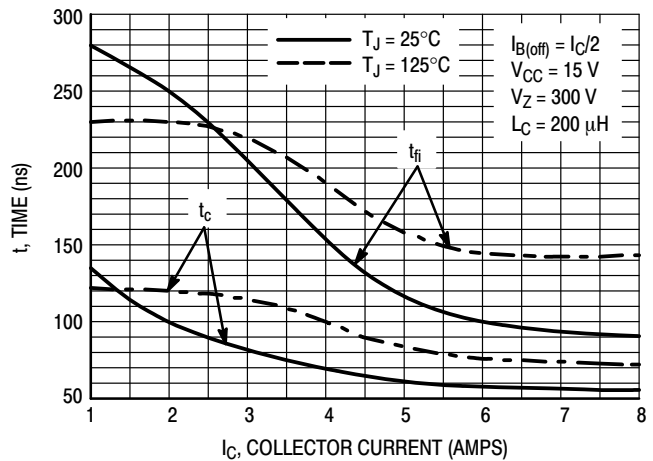

Figure 12. Inductive Switching, t_c and t_{fi}
 $I_C/I_B = 10$

MJE18008

TYPICAL SWITCHING CHARACTERISTICS

($I_{B2} = I_C/2$ for all switching) (continued)

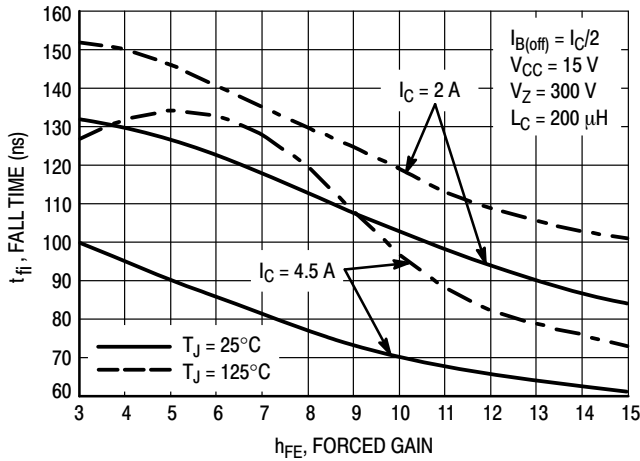

Figure 13. Inductive Fall Time

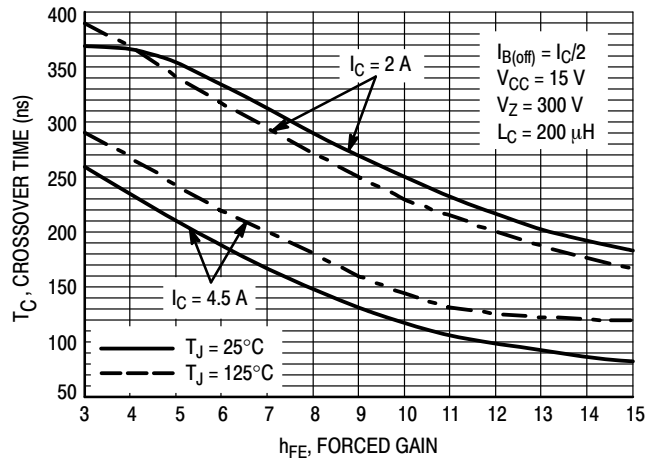

Figure 14. Inductive Crossover Time

GUARANTEED SAFE OPERATING AREA INFORMATION

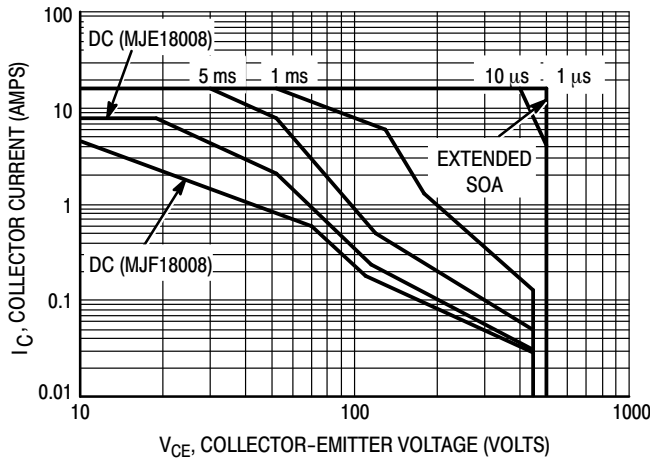

Figure 15. Forward Bias Safe Operating Area

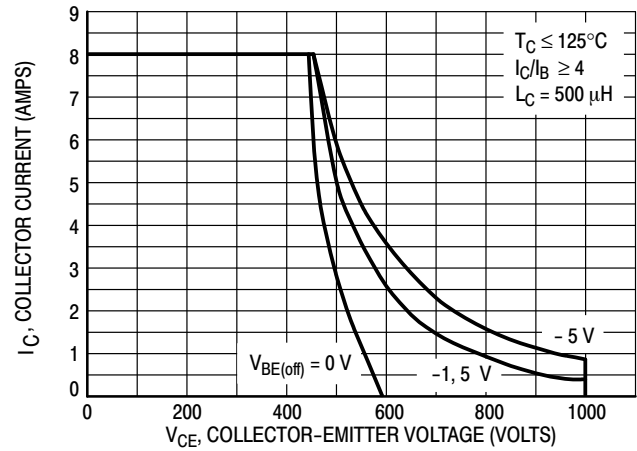

Figure 16. Reverse Bias Switching Safe Operating Area

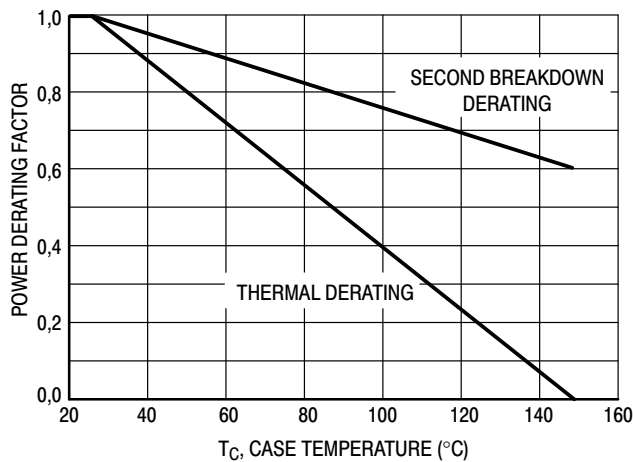

Figure 17. Forward Bias Power Derating

There are two limitations on the power handling ability of a transistor: average junction temperature and second breakdown. Safe operating area curves indicate $I_C - V_{CE}$

limits of the transistor that must be observed for reliable operation; i.e., the transistor must not be subjected to greater dissipation than the curves indicate. The data of Figure 15 is based on $T_C = 25^\circ\text{C}$; $T_{J(pk)}$ is variable depending on power level. Second breakdown pulse limits are valid for duty cycles to 10% but must be derated when $T_C > 25^\circ\text{C}$. Second breakdown limitations do not derate the same as thermal limitations. Allowable current at the voltages shown in Figure 15 may be found at any case temperature by using the appropriate curve on Figure 17. $T_{J(pk)}$ may be calculated from the data in Figure 20 and 21. At any case temperatures, thermal limitations will reduce the power that can be handled to values less than the limitations imposed by second breakdown. For inductive loads, high voltage and current must be sustained simultaneously during turn-off with the base-to-emitter junction reverse-biased. The safe level is specified as a reverse-biased safe operating area (Figure 16). This rating is verified under clamped conditions so that the device is never subjected to an avalanche mode.

MJE18008

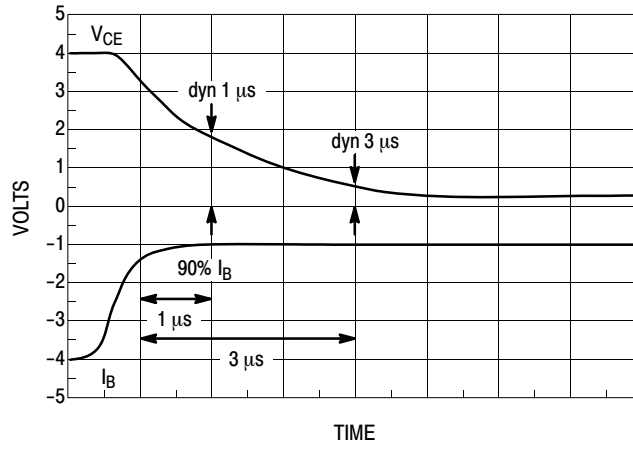

Figure 18. Dynamic Saturation Voltage Measurements

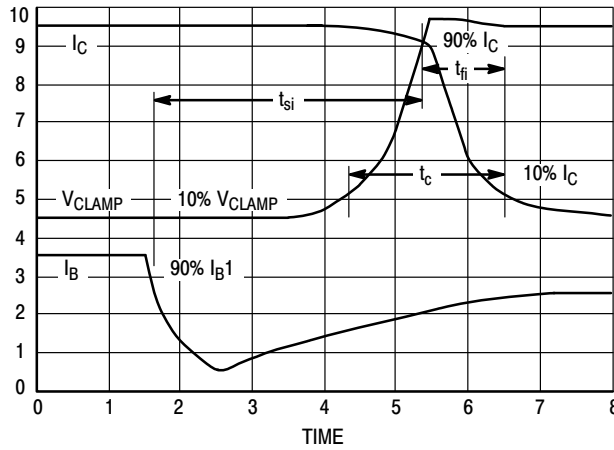

Figure 19. Inductive Switching Measurements

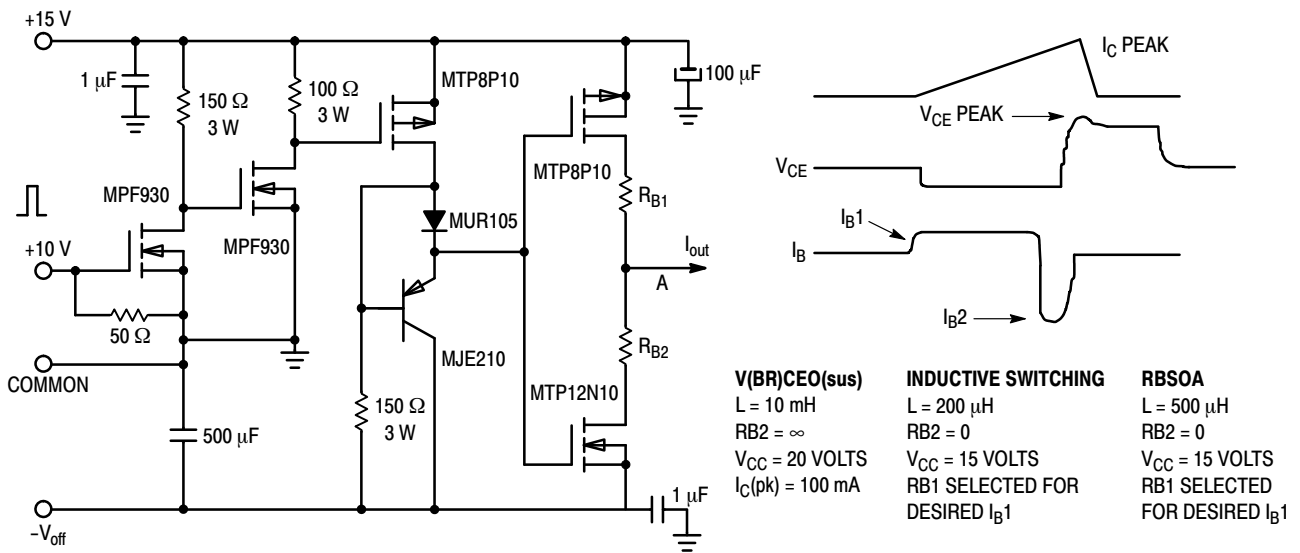

Table 1. Inductive Load Switching Drive Circuit

MJE18008

TYPICAL THERMAL RESPONSE

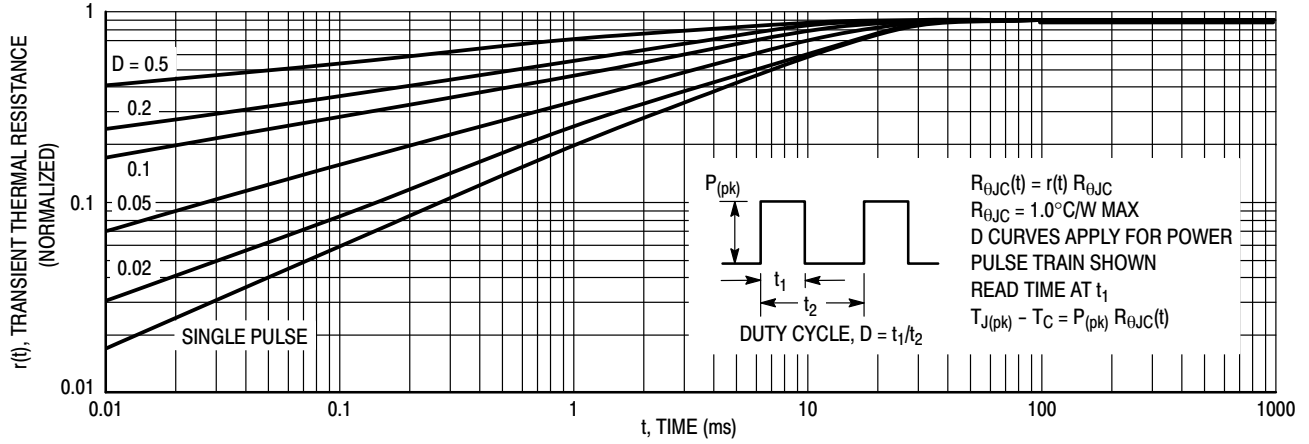

Figure 20. Typical Thermal Response ($Z_{\theta_{JC}}(t)$) for MJE18008

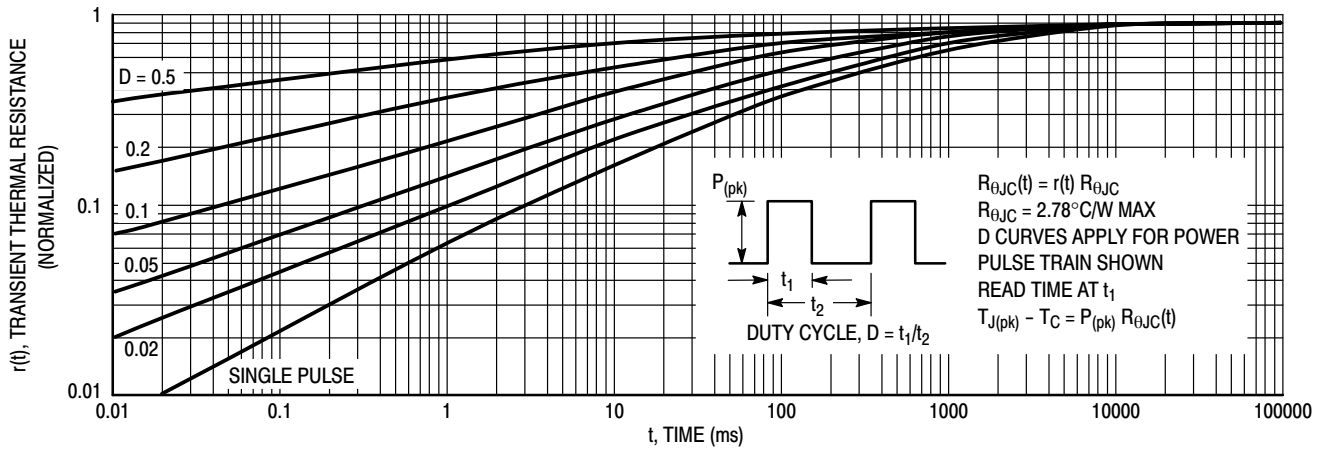

Figure 21. Typical Thermal Response ($Z_{\theta_{JC}}(t)$) for MJF18008

MJE18008

TEST CONDITIONS FOR ISOLATION TESTS*

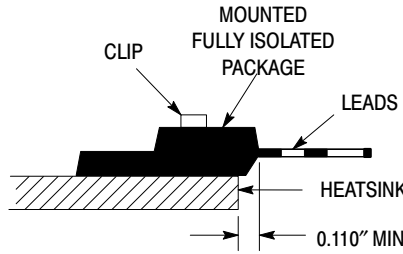

Figure 22a. Screw or Clip Mounting Position for Isolation Test Number 1

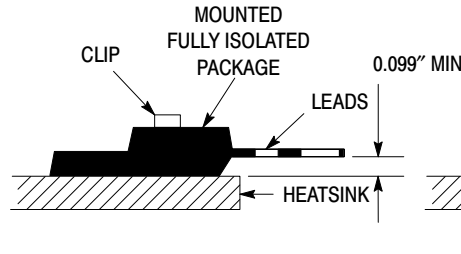

Figure 22b. Clip Mounting Position for Isolation Test Number 2

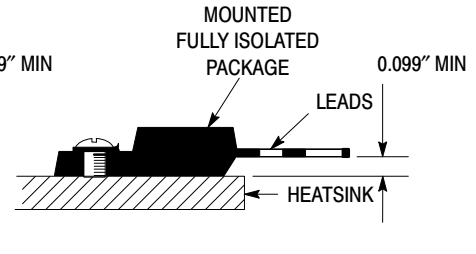

Figure 22c. Screw Mounting Position for Isolation Test Number 3

*Measurement made between leads and heatsink with all leads shorted together

MOUNTING INFORMATION**

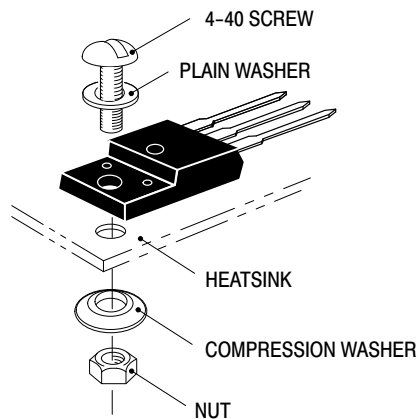

Figure 23a. Screw-Mounted

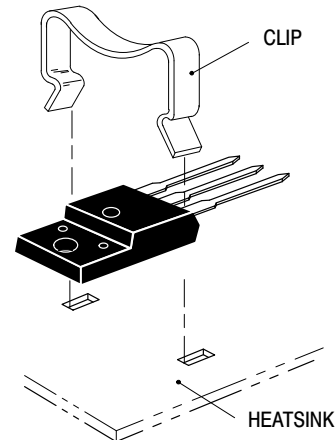

Figure 23b. Clip-Mounted

Figure 23. Typical Mounting Techniques for Isolated Package

Laboratory tests on a limited number of samples indicate, when using the screw and compression washer mounting technique, a screw torque of 6 to 8 in · lbs is sufficient to provide maximum power dissipation capability. The compression washer helps to maintain a constant pressure on the package over time and during large temperature excursions.

Destructive laboratory tests show that using a hex head 4-40 screw, without washers, and applying a torque in excess of 20 in · lbs will cause the plastic to crack around the mounting hole, resulting in a loss of isolation capability.

Additional tests on slotted 4-40 screws indicate that the screw slot fails between 15 to 20 in · lbs without adversely affecting the package. However, in order to positively ensure the package integrity of the fully isolated device, **onsemi** does not recommend exceeding 10 in · lbs of mounting torque under any mounting conditions.

** For more information about mounting power semiconductors see Application Note AN1040.

onsemi, **Onsemi**, and other names, marks, and brands are registered and/or common law trademarks of Semiconductor Components Industries, LLC dba "**onsemi**" or its affiliates and/or subsidiaries in the United States and/or other countries. **onsemi** owns the rights to a number of patents, trademarks, copyrights, trade secrets, and other intellectual property. A listing of **onsemi**'s product/patent coverage may be accessed at www.onsemi.com/site/pdf/Patent-Marking.pdf. **onsemi** reserves the right to make changes at any time to any products or information herein, without notice. The information herein is provided "as-is" and **onsemi** makes no warranty, representation or guarantee regarding the accuracy of the information, product features, availability, functionality, or suitability of its products for any particular purpose, nor does **onsemi** assume any liability arising out of the application or use of any product or circuit, and specifically disclaims any and all liability, including without limitation special, consequential or incidental damages. Buyer is responsible for its products and applications using **onsemi** products, including compliance with all laws, regulations and safety requirements or standards, regardless of any support or applications information provided by **onsemi**. "Typical" parameters which may be provided in **onsemi** data sheets and/or specifications can and do vary in different applications and actual performance may vary over time. All operating parameters, including "Typicals" must be validated for each customer application by customer's technical experts. **onsemi** does not convey any license under any of its intellectual property rights nor the rights of others. **onsemi** products are not designed, intended, or authorized for use as a critical component in life support systems or any FDA Class 3 medical devices or medical devices with a same or similar classification in a foreign jurisdiction or any devices intended for implantation in the human body. Should Buyer purchase or use **onsemi** products for any such unintended or unauthorized application, Buyer shall indemnify and hold **onsemi** and its officers, employees, subsidiaries, affiliates, and distributors harmless against all claims, costs, damages, and expenses, and reasonable attorney fees arising out of, directly or indirectly, any claim of personal injury or death associated with such unintended or unauthorized use, even if such claim alleges that **onsemi** was negligent regarding the design or manufacture of the part. **onsemi** is an Equal Opportunity/Affirmative Action Employer. This literature is subject to all applicable copyright laws and is not for resale in any manner.

ADDITIONAL INFORMATION

TECHNICAL PUBLICATIONS:

Technical Library: www.onsemi.com/design/resources/technical-documentation
onsemi Website: www.onsemi.com

ONLINE SUPPORT: www.onsemi.com/support

For additional information, please contact your local Sales Representative at www.onsemi.com/support/sales

OUR CERTIFICATE

DiGi provide top-quality products and perfect service for customer worldwide through standardization, technological innovation and continuous improvement. DiGi through third-party certification, we stricly control the quality of products and services. Welcome your RFQ to

Email: Info@DiGi-Electronics.com



Tel: +00 852-30501935

RFQ Email: Info@DiGi-Electronics.com

DiGi is a global authorized distributor of electronic components.