

NB4N111KMNR4G Datasheet

www.digi-electronics.com

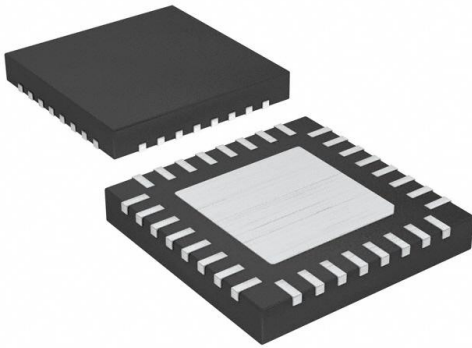

<https://www.DiGi-Electronics.com>

| | |
|------------------------------|--|
| DiGi Electronics Part Number | NB4N111KMNR4G-DG |
| Manufacturer | onsemi |
| Manufacturer Product Number | NB4N111KMNR4G |
| Description | IC CLK BUFFER 1:10 400MHZ 32QFN |
| Detailed Description | Clock Fanout Buffer (Distribution) IC 1:10 400 MHz 3 2-VFQFN Exposed Pad |



Tel: +00 852-30501935

RFQ Email: Info@DiGi-Electronics.com

DiGi is a global authorized distributor of electronic components.

Purchase and inquiry

Manufacturer Product Number:

NB4N111KMNR4G

Series:

-

Type:

Fanout Buffer (Distribution)

Ratio - Input:Output:

1:10

Input:

CML, LVCMOS, LVDS, LVPECL, LVTTTL

Frequency - Max:

400 MHz

Operating Temperature:

-40°C ~ 70°C

Package / Case:

32-VFQFN Exposed Pad

Base Product Number:

NB4N111

Manufacturer:

onsemi

Product Status:

Active

Number of Circuits:

1

Differential - Input:Output:

Yes/Yes

Output:

HCSL

Voltage - Supply:

3V ~ 3.6V

Mounting Type:

Surface Mount

Supplier Device Package:

32-QFN (5x5)

Environmental & Export classification

RoHS Status:

ROHS3 Compliant

REACH Status:

REACH Unaffected

HTSUS:

8542.39.0001

Moisture Sensitivity Level (MSL):

1 (Unlimited)

ECCN:

EAR99

3.3 V Differential In 1:10 Differential Fanout Clock Driver with HCSL Level Output

NB4N111K

Description

The NB4N111K is a differential input clock 1 to 10 HCSL fanout buffer, optimized for ultra low propagation delay variation. The NB4N111K is designed with HCSL clock distribution for FBDIMM applications in mind.

Inputs can accept differential LVPECL, CML, or LVDS levels. Single-ended LVPECL, CML, LVCMOS or LVTTL levels are accepted with the proper V_{REFAC} supply (see Figures 5, 10, 11, 12, and 13). Clock input pins incorporate an internal $50\ \Omega$ on die termination resistors. Outputs can interface with LVDS with proper termination (See Figure 15).

The NB4N111K specifically guarantees low output-to-output skews. Optimal design, layout, and processing minimize skew within a device and from device to device. System designers can take advantage of the NB4N111K's performance to distribute low skew clocks across the backplane or the motherboard.

Features

- Typical Input Clock Frequencies: 100, 133, 166, 200, 266, 333, and 400 MHz
- 340 ps Typical Rise and Fall Times
- 800 ps Typical Propagation Delay
- Δt_{pd} 100 ps Maximum Propagation Delay Variation Per Each Differential Pair
- <1 ps RMS Additive Clock jitter
- Operating Range: $V_{CC} = 3.0\text{ V to }3.6\text{ V}$ with $V_{EE} = 0\text{ V}$
- Differential HCSL Output Level or LVDS with Proper Termination
- These are Pb-Free Devices

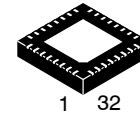

QFN32
MN SUFFIX
CASE 488AM

MARKING DIAGRAM*

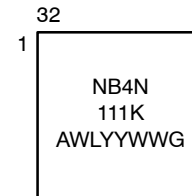

| | |
|----|-------------------|
| A | = Assembly Site |
| WL | = Wafer Lot |
| YY | = Year |
| WW | = Work Week |
| G | = Pb-Free Package |

*For additional marking information, refer to Application Note [AND8002/D](#).

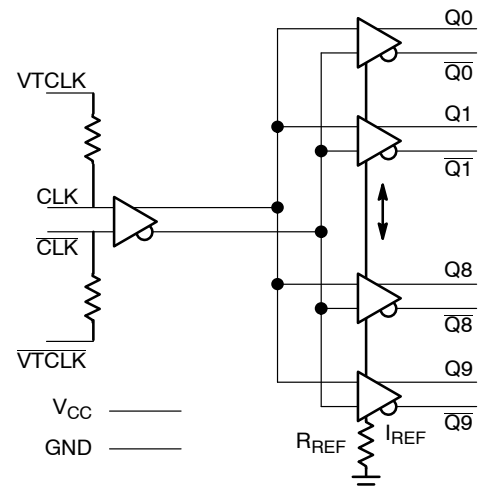
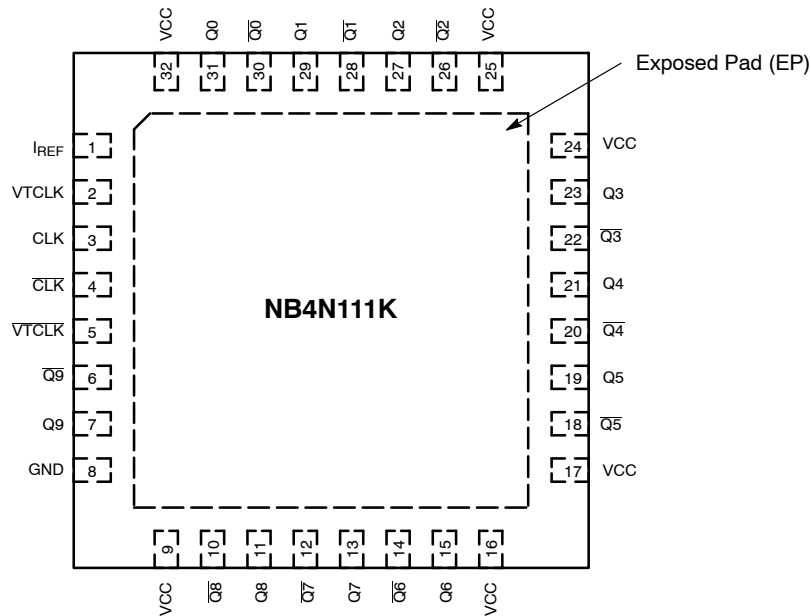

Figure 1. Pin Configuration (Top View)

ORDERING INFORMATION

See detailed ordering and shipping information in the package dimensions section on page 8 of this data sheet.

NB4N111K**Figure 2. Pinout Configuration (Top View)****Table 1. PIN DESCRIPTION**

| Pin | Name | I/O | Description |
|--|------------------|------------------------|--|
| 1 | I _{REF} | Output | Output current programming pin. Connect to GND. (See Figure 9). |
| 2, 5 | VTCLK, VTCLK | - | Internal 50 Ω Termination Resistor connection Pins. In the differential configuration when the input termination pins are connected to the common termination voltage, and if no signal is applied then the device may be susceptible to self-oscillation. |
| 3 | CLK | LVPECL Input | CLOCK Input (TRUE) |
| 4 | CLK | LVPECL Input | CLOCK Input (INVERT) |
| 8 | GND | - | Supply Ground. GND pin must be externally connected to power supply to guarantee proper operation. |
| 9, 16, 17, 24, 25, 32 | V _{CC} | - | Positive Supply pins. V _{CC} pins must be externally connected to a power supply to guarantee proper operation. |
| 6, 10, 12, 14, 18, 20, 22, 26, 28, 30 | Q[09-0] | HCSL or LVDS Output | Noninverted Clock Output. (For LVDS levels see Figure 15) |
| 7, 11, 13, 15, 19, 21, 23, 27, 29, 31 | Q[09-0] | HCSL or LVDS Output | Inverted Clock Output. (For LVDS levels see Figure 15) |
| Exposed Pad | EP | GND | Exposed Pad. The thermally exposed pad (EP) on package bottom (see case drawing) must be attached to a sufficient heat-sinking conduit for proper thermal operation. (Note 1) |

1. The exposed pad must be connected to the circuit board ground.

NB4N111K**Table 2. ATTRIBUTES**

| Characteristic | Value |
|--|----------------------|
| Input Default State Resistors | None |
| ESD Protection Human Body Model | >2 kV |
| Moisture Sensitivity (Note 2) QFN32 | Level 1 |
| Flammability Rating Oxygen Index: 28 to 34 | UL 94 V-0 @ 0.125 in |
| Transistor Count | 622 |
| Meets or exceeds JEDEC Spec EIA/JESD78 IC Latchup Test | |

2. For additional information, see Application Note AND8003/D.

Table 3. MAXIMUM RATINGS (Note 3)

| Symbol | Parameter | Condition 1 | Condition 2 | Rating | Unit |
|-------------------|---|--------------------|----------------|--|--------------|
| V _{CC} | Positive Power Supply | GND = 0 V | | 4.6 | V |
| V _I | Positive Input | GND = 0 V | | GND - 0.3 ≤ V _I ≤ V _{CC} | V |
| V _{INPP} | Differential Input Voltage CLK - $\overline{\text{CLK}}$ | | | V _{CC} | V |
| I _{OUT} | Output Current | Continuous Surge | | 50 100 | mA mA |
| T _A | Operating Temperature Range | QFN32 | | -40 to +70 | °C |
| T _{stg} | Storage Temperature Range | | | -65 to +150 | °C |
| θ _{JA} | Thermal Resistance (Junction-to-Ambient) (Note 3) | 0 lfpm 500 lfpm | QFN32 QFN32 | 31 27 | °C/W °C/W |
| θ _{JC} | Thermal Resistance (Junction-to-Case) | 2S2P (Note 4) | QFN32 | 12 | °C/W |
| T _{sol} | Wave Solder Pb-Free | | | 265 | °C |

Stresses exceeding those listed in the Maximum Ratings table may damage the device. If any of these limits are exceeded, device functionality should not be assumed, damage may occur and reliability may be affected.

3. JEDEC standard 51-6, multilayer board - 2S2P (2 signal, 2 power).

4. JEDEC standard multilayer board - 2S2P (2 signal, 2 power) with 8 filled thermal vias under exposed pad.

NB4N111K**Table 4. DC CHARACTERISTICS** ($V_{CC} = 3.0\text{ V to }3.6\text{ V}$, $T_A = -40^\circ\text{C to }+70^\circ\text{C}$ Note 5)

| Symbol | Characteristic | Min | Typ | Max | Unit |
|-----------|---|------|------|-----|---------------|
| I_{GND} | GND Supply Current (All Outputs Loaded) | 70 | 98 | 120 | mA |
| I_{CC} | Power Supply Current (All Outputs Loaded) | – | – | 300 | mA |
| I_{IH} | Input HIGH Current CLKx, $\overline{\text{CLKx}}$ | – | 2.0 | 150 | μA |
| I_{IL} | Input LOW Current CLKx, $\overline{\text{CLKx}}$ | –150 | –2.0 | – | μA |

DIFFERENTIAL INPUT DRIVEN SINGLE-ENDED (Figures 5 and 7)

| | | | | | |
|----------|--|----------------|---|----------------|----|
| V_{th} | Input Threshold Reference Voltage Range (Note 6) | 1050 | – | $V_{CC} - 150$ | mV |
| V_{IH} | Single-Ended Input HIGH Voltage | $V_{th} + 150$ | – | V_{CC} | mV |
| V_{IL} | Single-Ended Input LOW Voltage | GND | – | $V_{th} - 150$ | mV |

DIFFERENTIAL INPUTS DRIVEN DIFFERENTIALLY (Figures 6 and 8)

| | | | | | |
|-----------|--|------|---|---------------|----|
| V_{IHD} | Differential Input HIGH Voltage | 1200 | – | V_{CC} | mV |
| V_{ILD} | Differential Input LOW Voltage | GND | – | $V_{CC} - 75$ | mV |
| V_{ID} | Differential Input Voltage ($V_{IHD} - V_{ILD}$) | 75 | – | 2400 | mV |
| V_{CMR} | Input Common Mode Range | 1163 | – | $V_{CC} - 75$ | |

HCSL OUTPUTS (Figure 4)

| | | | | | |
|----------|---------------------|------|-----|-----|----|
| V_{OH} | Output HIGH Voltage | 600 | 740 | 900 | mV |
| V_{OL} | Output LOW Voltage | –150 | 0 | 150 | mV |

NOTE: Device will meet the specifications after thermal equilibrium has been established when mounted in a test socket or printed circuit board with maintained transverse airflow greater than 500 lfpm.

5. Input parameters vary 1:1 with V_{CC} . Measurements taken with all outputs loaded $50\ \Omega$ to GND, see Figure 9.
6. V_{th} is applied to the complementary input when operating in single ended mode.

NB4N111K**Table 5. AC CHARACTERISTICS** $V_{CC} = 3.0\text{ V to }3.6\text{ V}$, $GND = 0\text{ V}$; $-40^{\circ}\text{C to }+70^{\circ}\text{C}$ (Note 7)

| Symbol | Characteristic | Min | Typ | Max | Unit | |
|--|---|-----|-----|------------------|----------------|----|
| V_{OUTPP} | Output Voltage Amplitude (@ $V_{INPPmin}$) | | 725 | 1000 | mV | |
| t_{PLH} , t_{PHL} | Propagation Delay to (See Figure 3) | | 550 | 800 | ps | |
| Δt_{PLH} , Δt_{PHL} | Propagation Delay Variations Variation Per Each Diff Pair CLK/CLK to Qx/Qx (Note 8) (See Figure 3) | - | - | 100 | ps | |
| t_{SKEW} | Duty Cycle Skew (Note 9) Within-Device Skew Device-to-Device Skew (Note 10) | - | - | 20 100 150 | ps ps ps | |
| t_{JITTER} | RMS Random Clock Jitter (Note 11) | | | 1 | ps | |
| V_{cross} | Absolute Crossing Magnitude Voltage | 250 | - | 550 | mV | |
| ΔV_{cross} | Variation in Magnitude of V_{cross} | - | - | 150 | mV | |
| t_r , t_f | Absolute Magnitude in Output Risetime and Falltime (From 175 mV to 525 mV) | | 175 | 340 | 700 | ps |
| Δt_r , Δt_f | Variation in Magnitude of Risetime and Falltime (Single-Ended) (See Figure 4) | | | 125 | ps | |

NOTE: Device will meet the specifications after thermal equilibrium has been established when mounted in a test socket or printed circuit board with maintained transverse airflow greater than 500 lfm.

7. Measured by forcing V_{INPP} (MIN) from a 50% duty cycle clock source. Measurements taken with all outputs loaded $50\ \Omega$ to GND, see Figure 9. Typical gain is 20 dB.
8. Measured from the input pair crosspoint to each single output pair crosspoint across temp and voltage ranges.
9. Duty cycle skew is measured between differential outputs using the deviations of the sum of $Tpw-$ and $Tpw+$.
10. Skew is measured between outputs under identical transition @ 400 MHz.
11. Additive RMS jitter with 50% duty cycle clock signal using phase noise integrated from 12 KHz to 33 MHz

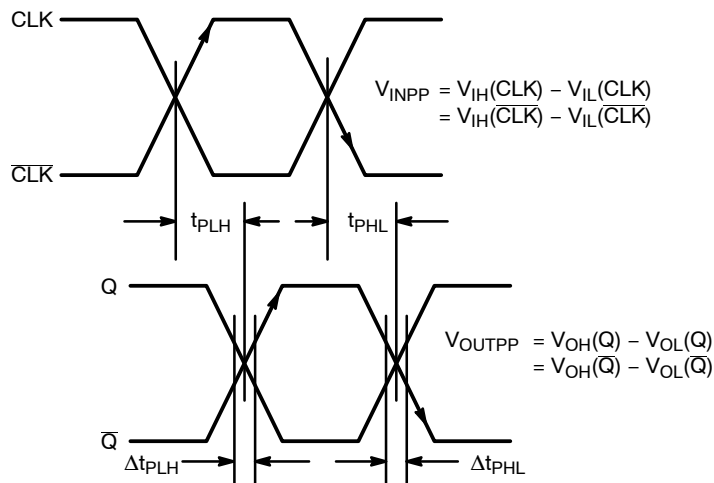
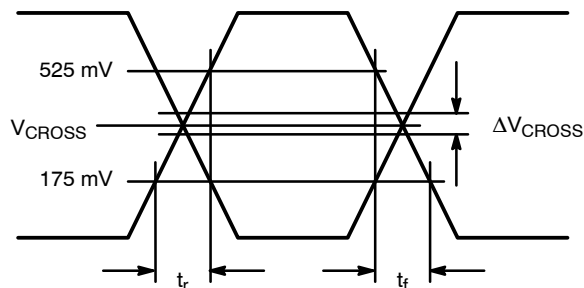
**Figure 3. AC Reference Measurement****Figure 4. HCSL Output Parameter Characteristics**

NB4N111K

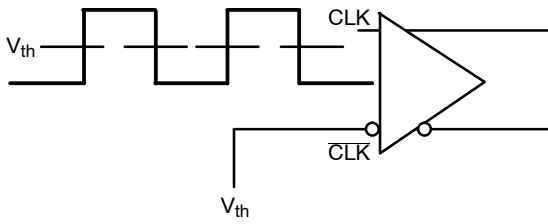

Figure 5. Differential Input Driven Single-Ended ($V_{th} = V_{REFAC}$)

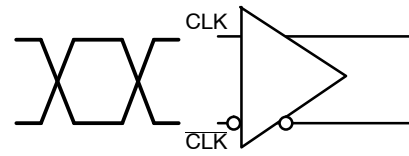

Figure 6. Differential Inputs Driven Differentially

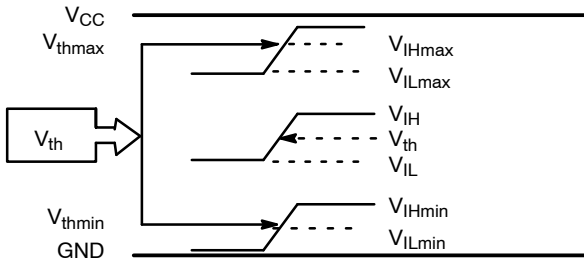

Figure 7. V_{th} Diagram

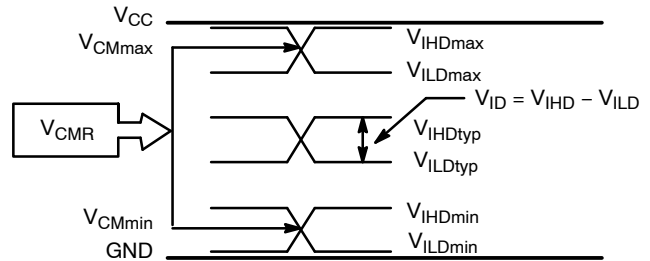
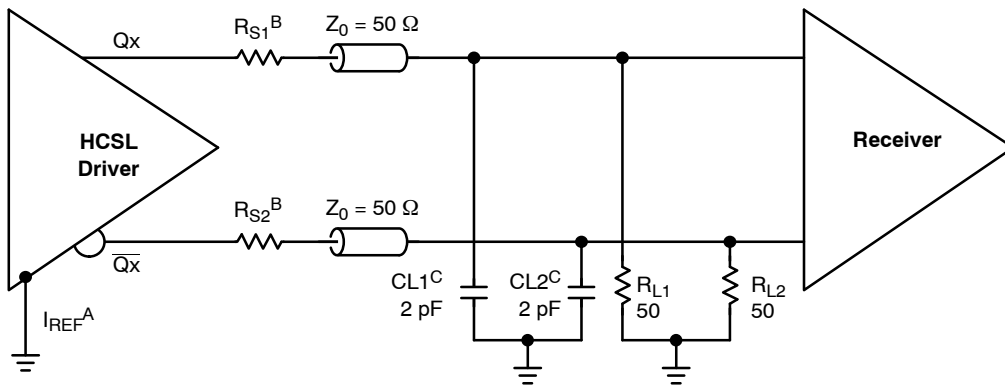

Figure 8. V_{CMR} Diagram



- A.** Connect I_{REF} pin to GND.
- B.** $RS1$, $RS2$: 0Ω for Test and Evaluation. Select to Minimizing Ringing.
- C.** $CL1$, $CL2$: Receiver Input Simulation Load Capacitance Only.

Figure 9. Typical Termination Configuration for Output Driver and Device Evaluation C_{Lx} for Test Only (Representing Receiver Input Loading); Not Added to Application

NB4N111K

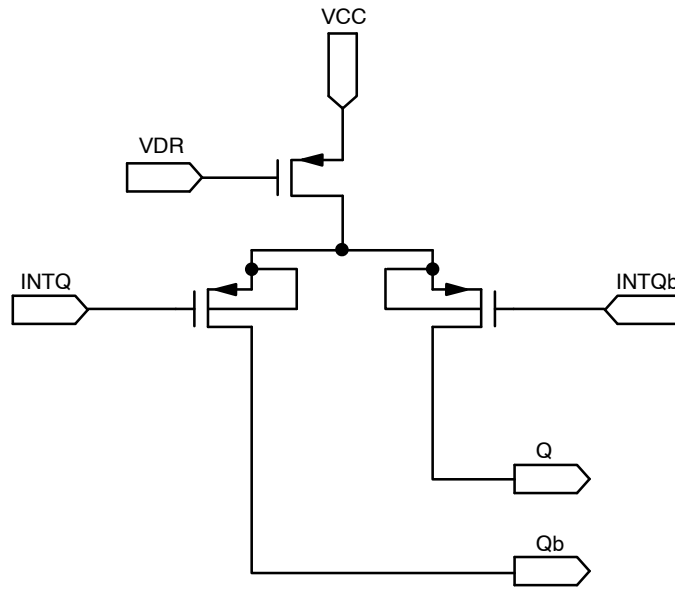

Figure 14. HCSL Output Structure

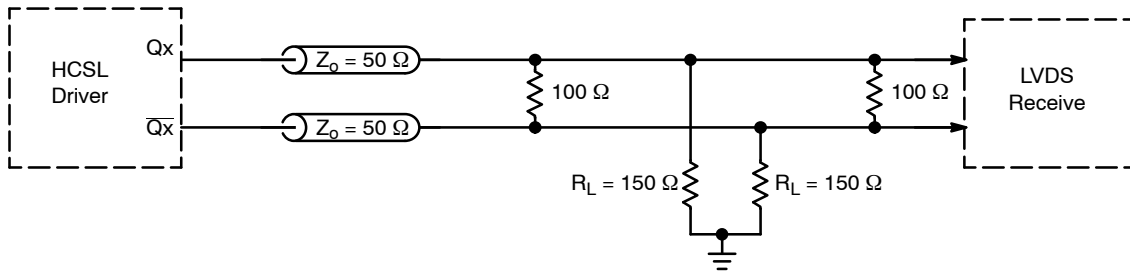

Figure 15. HCSL Interface Termination to LVDS

ORDERING INFORMATION

| Device | Package | Shipping [†] |
|---------------|--------------------|-----------------------|
| NB4N111KMNG | QFN32 (Pb-Free) | 74 / Tube |
| NB4N111KMNR4G | QFN32 (Pb-Free) | 1000 / Tape & Reel |

[†]For information on tape and reel specifications, including part orientation and tape sizes, please refer to our Tape and Reel Packaging Specifications Brochure, [BRD8011/D](#).



**MECHANICAL CASE OUTLINE
PACKAGE DIMENSIONS**

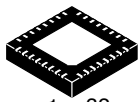

1 32
SCALE 2:1

**QFN32 5x5, 0.5P
CASE 488AM
ISSUE A**

DATE 23 OCT 2013

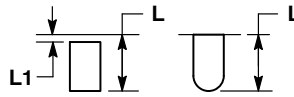
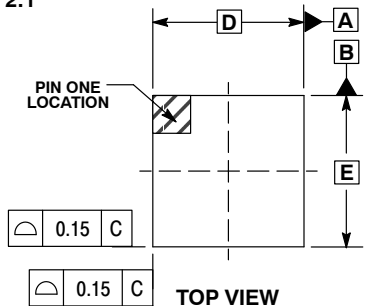

- NOTES:
1. DIMENSIONS AND TOLERANCING PER ASME Y14.5M, 1994.
 2. CONTROLLING DIMENSION: MILLIMETERS.
 3. DIMENSION b APPLIES TO PLATED TERMINAL AND IS MEASURED BETWEEN 0.15 AND 0.30MM FROM THE TERMINAL TIP.
 4. COPLANARITY APPLIES TO THE EXPOSED PAD AS WELL AS THE TERMINALS.

| MILLIMETERS | | |
|-------------|------|------|
| DIM | MIN | MAX |
| A | 0.80 | 1.00 |
| A1 | --- | 0.05 |
| A3 | 0.20 | REF |
| b | 0.18 | 0.30 |
| D | 5.00 | BSC |
| D2 | 2.95 | 3.25 |
| E | 5.00 | BSC |
| E2 | 2.95 | 3.25 |
| e | 0.50 | BSC |
| K | 0.20 | --- |
| L | 0.30 | 0.50 |
| L1 | --- | 0.15 |

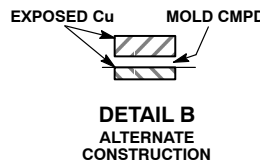
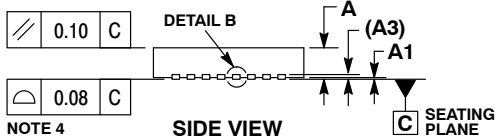

GENERIC MARKING DIAGRAM*

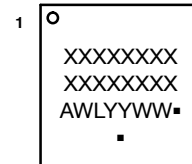
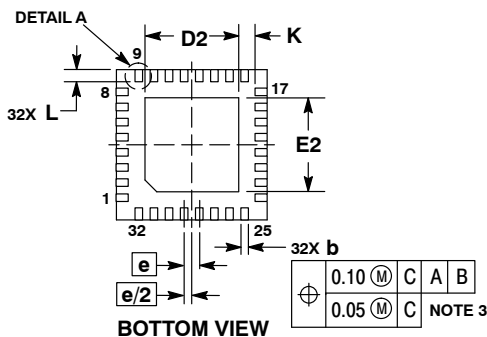

- XXXXX = Specific Device Code
- A = Assembly Location
- WL = Wafer Lot
- YY = Year
- WW = Work Week
- = Pb-Free Package

(Note: Microdot may be in either location)
*This information is generic. Please refer to device data sheet for actual part marking.
Pb-Free indicator, "G" or microdot "▪", may or may not be present.

RECOMMENDED SOLDERING FOOTPRINT*

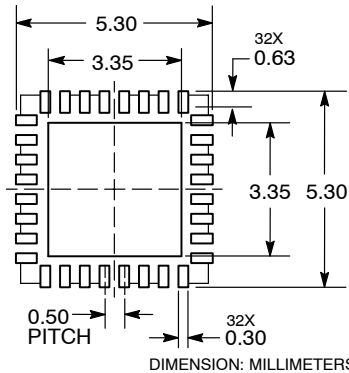

*For additional information on our Pb-Free strategy and soldering details, please download the ON Semiconductor Soldering and Mounting Techniques Reference Manual, SOLDERRM/D.

| | | |
|-------------------------|-----------------------|--|
| DOCUMENT NUMBER: | 98AON20032D | Electronic versions are uncontrolled except when accessed directly from the Document Repository. Printed versions are uncontrolled except when stamped "CONTROLLED COPY" in red. |
| DESCRIPTION: | QFN32 5x5 0.5P | PAGE 1 OF 1 |

onsemi and Onsemi are trademarks of Semiconductor Components Industries, LLC dba onsemi or its subsidiaries in the United States and/or other countries. onsemi reserves the right to make changes without further notice to any products herein. onsemi makes no warranty, representation or guarantee regarding the suitability of its products for any particular purpose, nor does onsemi assume any liability arising out of the application or use of any product or circuit, and specifically disclaims any and all liability, including without limitation special, consequential or incidental damages. onsemi does not convey any license under its patent rights nor the rights of others.

onsemi, **Onsemi**, and other names, marks, and brands are registered and/or common law trademarks of Semiconductor Components Industries, LLC dba "**onsemi**" or its affiliates and/or subsidiaries in the United States and/or other countries. **onsemi** owns the rights to a number of patents, trademarks, copyrights, trade secrets, and other intellectual property. A listing of **onsemi**'s product/patent coverage may be accessed at www.onsemi.com/site/pdf/Patent-Marking.pdf. **onsemi** reserves the right to make changes at any time to any products or information herein, without notice. The information herein is provided "as-is" and **onsemi** makes no warranty, representation or guarantee regarding the accuracy of the information, product features, availability, functionality, or suitability of its products for any particular purpose, nor does **onsemi** assume any liability arising out of the application or use of any product or circuit, and specifically disclaims any and all liability, including without limitation special, consequential or incidental damages. Buyer is responsible for its products and applications using **onsemi** products, including compliance with all laws, regulations and safety requirements or standards, regardless of any support or applications information provided by **onsemi**. "Typical" parameters which may be provided in **onsemi** data sheets and/or specifications can and do vary in different applications and actual performance may vary over time. All operating parameters, including "Typicals" must be validated for each customer application by customer's technical experts. **onsemi** does not convey any license under any of its intellectual property rights nor the rights of others. **onsemi** products are not designed, intended, or authorized for use as a critical component in life support systems or any FDA Class 3 medical devices or medical devices with a same or similar classification in a foreign jurisdiction or any devices intended for implantation in the human body. Should Buyer purchase or use **onsemi** products for any such unintended or unauthorized application, Buyer shall indemnify and hold **onsemi** and its officers, employees, subsidiaries, affiliates, and distributors harmless against all claims, costs, damages, and expenses, and reasonable attorney fees arising out of, directly or indirectly, any claim of personal injury or death associated with such unintended or unauthorized use, even if such claim alleges that **onsemi** was negligent regarding the design or manufacture of the part. **onsemi** is an Equal Opportunity/Affirmative Action Employer. This literature is subject to all applicable copyright laws and is not for resale in any manner.

ADDITIONAL INFORMATION

TECHNICAL PUBLICATIONS:

Technical Library: www.onsemi.com/design/resources/technical-documentation
onsemi Website: www.onsemi.com

ONLINE SUPPORT: www.onsemi.com/support

For additional information, please contact your local Sales Representative at www.onsemi.com/support/sales

OUR CERTIFICATE

DiGi provide top-quality products and perfect service for customer worldwide through standardization, technological innovation and continuous improvement. DiGi through third-party certification, we stricly control the quality of products and services. Welcome your RFQ to

Email: Info@DiGi-Electronics.com



Tel: +00 852-30501935

RFQ Email: Info@DiGi-Electronics.com

DiGi is a global authorized distributor of electronic components.