

# NCV47823PAAJR2G Datasheet

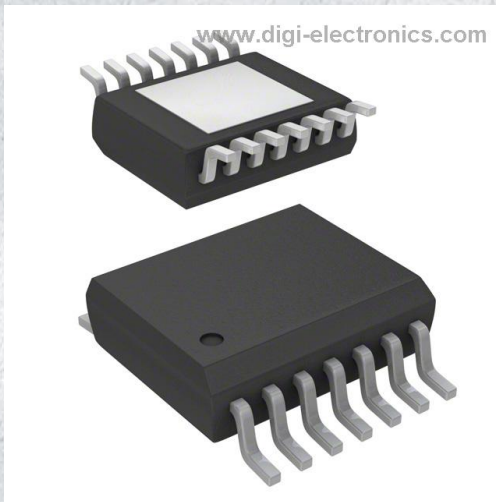

<https://www.DiGi-Electronics.com>

DiGi Electronics Part Number	NCV47823PAAJR2G-DG
Manufacturer	<a href="#">onsemi</a>
Manufacturer Product Number	NCV47823PAAJR2G
Description	IC PWR SWTCH BIPOLAR 1:2 14TSSOP
Detailed Description	Power Switch/Driver 1:2 Bipolar 350mA 14-TSSOP-EP



Tel: +00 852-30501935

RFQ Email: [Info@DiGi-Electronics.com](mailto:Info@DiGi-Electronics.com)

DiGi is a global authorized distributor of electronic components.

## Purchase and inquiry

Manufacturer Product Number:

NCV47823PAAJR2G

Series:

-

Switch Type:

General Purpose

Ratio - Input:Output:

1:2

Output Type:

Bipolar

Voltage - Load:

40V

Current - Output (Max):

350mA

Input Type:

Non-Inverting

Fault Protection:

Current Limiting (Adjustable), Over Temperature

Grade:

Automotive

Mounting Type:

Surface Mount

Package / Case:

14-TSSOP (0.173", 4.40mm Width) Exposed Pad

Manufacturer:

onsemi

Product Status:

Active

Number of Outputs:

2

Output Configuration:

High Side

Interface:

Logic

Voltage - Supply (Vcc/Vdd):

Not Required

Rds On (Typ):

-

Features:

PWM Input

Operating Temperature:

-40°C ~ 150°C (TJ)

Qualification:

AEC-Q100

Supplier Device Package:

14-TSSOP-EP

Base Product Number:

NCV47823

## Environmental & Export classification

RoHS Status:

ROHS3 Compliant

REACH Status:

REACH Unaffected

HTSUS:

8542.39.0001

Moisture Sensitivity Level (MSL):

1 (Unlimited)

ECCN:

EAR99

# Dual High Side Switch with Adjustable Constant Current and Diagnostic Features

## NCV47823

The NCV47823 is designed for using in harsh automotive environments providing dual mode operation depending on the load impedance: High Side Switch (HSS) or Constant Current Source (CCS). In both modes of operation the current limit can be set up to 350 mA per channel by external resistor. The device has a high peak input voltage tolerance and reverse input voltage, reverse bias, overcurrent and overtemperature protections. The integrated current sense feature (adjustable by resistor connected to CSO pin for each channel) provides diagnosis and system protection functionality. The CSO pin output current creates voltage drop across CSO resistor which is proportional to output current of each channel. Extended diagnostic features in OFF state are also available and controlled by dedicated input and output pins.

### Features

- Reduced Inrush Current (current value set by external resistor only)
- Adjustable Constant Current: up to 350 mA
- Two Independent Enable Inputs (3.3 V Logic Compatible)
- PWM Function of Enable Inputs Available
- Protection Features:
  - ◆ Current Limitation
  - ◆ Thermal Shutdown
  - ◆ Reverse Input Voltage and Reverse Bias Voltage
  - ◆ Reduced Reverse Bias Current
- Diagnostic Features:
  - ◆ Short To Battery (STB) and Open Load (OL) in OFF State
  - ◆ Internal Components for OFF State Diagnostics
  - ◆ Open Collector Flag Output
  - ◆ Two Output Voltage Monitoring Outputs (Analog)
- AEC-Q100 Grade 1 Qualified and PPAP Capable
- These Devices are Pb-Free, Halogen Free/BFR Free and are RoHS Compliant

### Typical Applications

- Audio and Infotainment System
- Active Safety System
- LED Lighting Systems

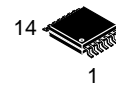

TSSOP-14  
Exposed Pad  
CASE 948AW

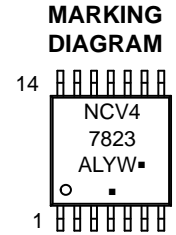

A = Assembly Location  
 L = Wafer Lot  
 Y = Year  
 W = Work Week  
 ■ = Pb-Free Package

(Note: Microdot may be in either location)

### ORDERING INFORMATION

See detailed ordering and shipping information on page 14 of sheet.

### NCV47823

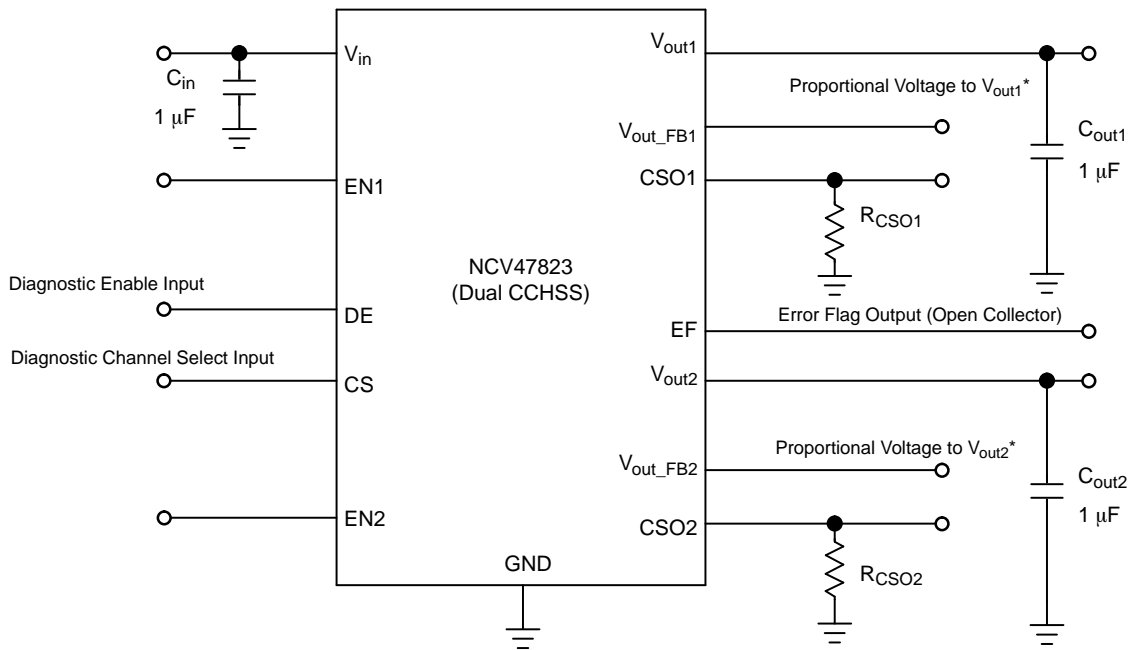

**Figure 1. Application Schematic**

\*  $V_{out\_FB1}$  and  $V_{out\_FB2}$  are sensed  $V_{out1}$  and  $V_{out2}$  output voltages, respectively, via internal resistor dividers

### NCV47823

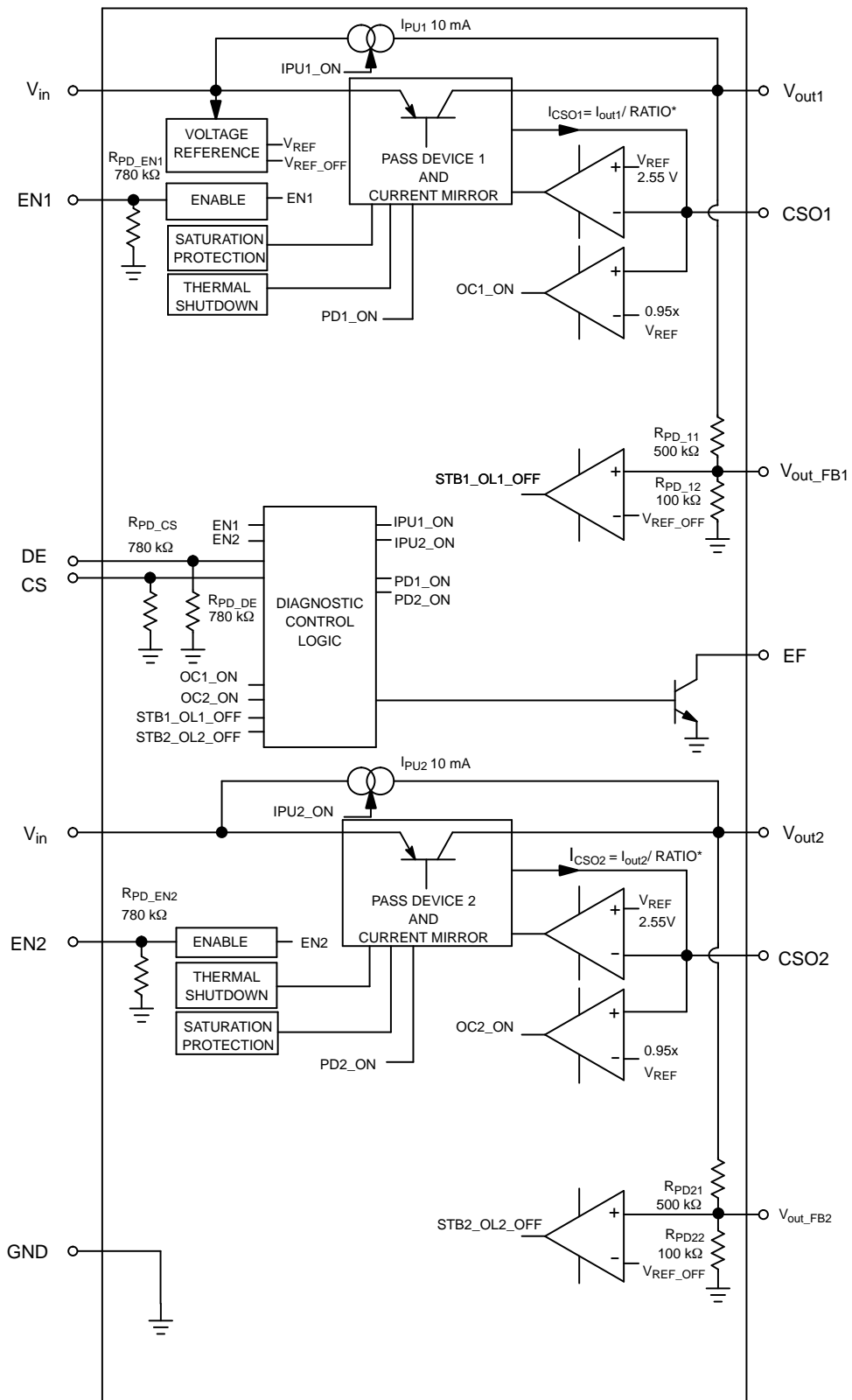

\* for current value of RATIO see into Electrical Characteristic Table

Figure 2. Simplified Block Diagram

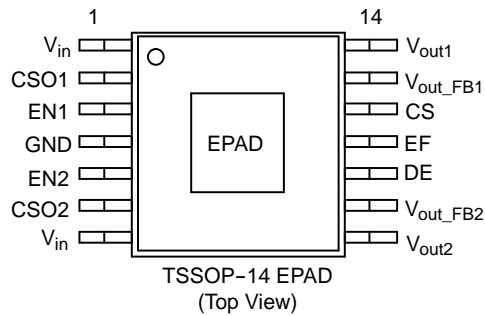
**NCV47823****Figure 3. Pin Connections****Table 1. PIN FUNCTION DESCRIPTION**

Pin No. TSSOP-14 EPAD	Pin Name	Description
1	$V_{in}$	Power Supply Input for Channel 1 and supply of control circuits of whole chip. At least 4.4 V power supply must be used for proper IC functionality.
2	CSO1	Current Sense Output 1, Current Limit setting and Output Current value information. See Application Section for more details.
3	EN1	Enable Input 1; low level disables the Channel 1. (Used also for OFF state diagnostics control for Channel 1)
4	GND	Power Supply Ground.
5	EN2	Enable Input 2; low level disables the Channel 2. (Used also for OFF state diagnostics control for Channel 2)
6	CSO2	Current Sense Output 2, Current Limit setting and Output Current value information. See Application Section for more details.
7	$V_{in}$	Power Supply Input for Channel 2. Connect to pin 1 or different power supply rail.
8	$V_{out2}$	Output Voltage 2.
9	$V_{out\_FB2}$	Output Voltage 2 Analog Monitoring. See Application Section for more details.
10	DE	Diagnostic Enable Input.
11	EF	Error Flag (Open Collector) Output. Active Low.
12	CS	Channel Select Input for OFF state diagnostics. Set CS = Low for OFF state diagnostics of Channel 1. Set CS = High for OFF state diagnostics of Channel 2. Corresponding EN pin has to be used for diagnostics control (see Application Information section for more details).
13	$V_{out\_FB1}$	Output Voltage 1 Analog Monitoring. See Application Section for more details.
14	$V_{out1}$	Output Voltage 1.
EPAD	EPAD	Exposed Pad is connected to Ground. Connect to GND plane on PCB.

**NCV47823****Table 2. MAXIMUM RATINGS**

Rating	Symbol	Min	Max	Unit
Input Voltage DC	$V_{in}$	-42	45	V
Input Voltage (Note 1) Load Dump – Suppressed	$U_{s^+}$	-	60	V
Enable Input Voltage	$V_{EN1,2}$	-42	45	V
Output Voltage Monitoring	$V_{out\_FB1,2}$	-0.3	10	V
CSO Voltage	$V_{CSO1,2}$	-0.3	7	V
DE, CS and EF Voltages	$V_{DE}, V_{CS}, V_{EF}$	-0.3	7	V
Output Voltage	$V_{out1,2}$	-1	40	V
Junction Temperature	$T_J$	-40	150	°C
Storage Temperature	$T_{STG}$	-55	150	°C

Stresses exceeding those listed in the Maximum Ratings table may damage the device. If any of these limits are exceeded, device functionality should not be assumed, damage may occur and reliability may be affected.

1. Load Dump Test B (with centralized load dump suppression) according to ISO16750-2 standard. Guaranteed by design. Not tested in production. Passed Class A according to ISO16750-1.

**Table 3. ESD CAPABILITY** (Note 2)

Rating	Symbol	Min	Max	Unit
ESD Capability, Human Body Model	$ESD_{HBM}$	-2	2	kV

2. This device series incorporates ESD protection and is tested by the following methods.

ESD Human Body Model tested per AEC-Q100-002 (JS-001-2010)

Field Induced Charge Device Model ESD characterization is not performed on plastic molded packages with body sizes < 50 mm<sup>2</sup> due to the inability of a small package body to acquire and retain enough charge to meet the minimum CDM discharge current waveform characteristic defined in JEDEC JS-002-2014.

**Table 4. LEAD SOLDERING TEMPERATURE AND MSL** (Note 3)

Rating	Symbol	Min	Max	Unit
Moisture Sensitivity Level	MSL		1	-

3. For more information, please refer to our Soldering and Mounting Techniques Reference Manual, SOLDERRM/D

**Table 5. THERMAL CHARACTERISTICS** (Note 4)

Rating	Symbol	Value	Unit
Thermal Characteristics (single layer PCB) Thermal Resistance, Junction-to-Air (Note 5) Thermal Reference, Junction-to-Lead (Note 5)	$R_{\theta JA}$ $R_{\psi JL}$	52 9.0	°C/W
Thermal Characteristics (4 layers PCB) Thermal Resistance, Junction-to-Air (Note 5) Thermal Reference, Junction-to-Lead (Note 5)	$R_{\theta JA}$ $R_{\psi JL}$	31 10	°C/W

4. Refer to ELECTRICAL CHARACTERISTICS and APPLICATION INFORMATION for Safe Operating Area.

5. Values based on copper area of 645 mm<sup>2</sup> (or 1 in<sup>2</sup>) of 1 oz copper thickness and FR4 PCB substrate. Single layer – according to JEDEC51.3, 4 layers – according to JEDEC51.7

**NCV47823****Table 6. RECOMMENDED OPERATING RANGES**

Rating	Symbol	Min	Max	Unit
Input Voltage (Note 6)	$V_{in}$	4.4	40	V
Output Current Limit (Note 7)	$I_{LIM1,2}$	10	350	mA
Junction Temperature	$T_J$	-40	150	°C

Functional operation above the stresses listed in the Recommended Operating Ranges is not implied. Extended exposure to stresses beyond the Recommended Operating Ranges limits may affect device reliability.

6. Minimum  $V_{in} = 4.4$  V or ( $V_{out1,2} + 0.5$  V), whichever is higher.

7. Corresponding  $R_{CSO1,2}$  is in range from 67.5 k $\Omega$  down to 2040  $\Omega$

**Table 7. ELECTRICAL CHARACTERISTICS**  $V_{in} = 13.5$  V,  $V_{EN1,2} = 3.3$  V,  $V_{DE} = 0$  V,  $R_{CSO1,2} = 0$   $\Omega$ ,  $C_{in} = 1$   $\mu$ F,  $C_{out1,2} = 1$   $\mu$ F, Min and Max values are valid for temperature range  $-40^{\circ}\text{C} \leq T_J \leq +150^{\circ}\text{C}$  unless noted otherwise and are guaranteed by test, design or statistical correlation. Typical values are referenced to  $T_J = 25^{\circ}\text{C}$  (Note 8)

Parameter	Test Conditions	Symbol	Min	Typ	Max	Unit
-----------	-----------------	--------	-----	-----	-----	------

**OUTPUTS**

Input to Output Differential Voltage	$V_{in} = 8$ V to 18 V $I_{out1,2} = 200$ mA $I_{out1,2} = 250$ mA	$V_{in-out1,2}$	-	210 230	350 400	mV
--------------------------------------	--	-----------------	---	------------	------------	----

**CURRENT LIMIT PROTECTION**

Current Limit	$V_{out1,2} = V_{in} - 1$ V	$I_{LIM1,2}$	350	-	-	mA
---------------	-----------------------------	--------------	-----	---	---	----

**DISABLE AND QUIESCENT CURRENTS**

Disable Current	$V_{EN1,2} = 0$ V	$I_{DIS}$	-	5	20	$\mu$ A
Quiescent Current, $I_q = I_{in} - (I_{out1} + I_{out2})$	$I_{out1} = I_{out2} = 500$ $\mu$ A, $V_{in} = 8$ V to 18 V	$I_q$	-	0.85	1.5	mA
Quiescent Current, $I_q = I_{in} - (I_{out1} + I_{out2})$	$I_{out1} = I_{out2} = 200$ mA, $V_{in} = 8$ V to 18 V	$I_q$	-	15	25	mA
Quiescent Current, $I_q = I_{in} - (I_{out1} + I_{out2})$	$I_{out1} = I_{out2} = 250$ mA, $V_{in} = 8$ V to 18 V	$I_q$	-	20	40	mA

**ENABLE**

Enable Input Threshold Voltage Logic Low (OFF) Logic High (ON)	$V_{out1,2} \leq 0.1$ V $V_{out1,2} \geq V_{in} - 1$ V	$V_{th(EN1,2)}$	0.99 -	1.8 1.9	- 2.31	V
Enable Input Current	$V_{EN1,2} = 3.3$ V	$I_{EN1,2}$	2	7	20	$\mu$ A
Turn On Time from from Enable ON to $V_{out1,2} = V_{in} - 1$ V	$I_{out1,2} = 100$ mA	$t_{on}$	-	25	-	$\mu$ s

**OUTPUT CURRENT SENSE**

CSO Voltage Level at Current Limit	$V_{out1,2} = V_{in} - 1$ V $R_{CSO1,2} = 3.3$ k $\Omega$	$V_{CSO\_lim1,2}$	2.474 (-3 %)	2.55	2.626 (+3 %)	V
CSO Transient Voltage Level	$R_{CSO1,2} = 3.3$ k $\Omega$ $I_{out1,2}$ pulse from 10 mA to 350 mA, $t_r = 1$ $\mu$ s	$V_{CSO1,2}$	-	-	3.3	V
Output Current to CSO Current Ratio	$V_{CSO1,2} = 2$ V, $I_{out1,2} = 10$ mA to 50 mA $V_{in} = 8$ V to 18 V, $-40^{\circ}\text{C} \leq T_J \leq +150^{\circ}\text{C}$	$I_{out1,2}/I_{CSO1,2}$	- (-15 %)	265	- (+15 %)	-
	$V_{CSO1,2} = 2$ V, $I_{out1,2} = 50$ mA to 200 mA $V_{in} = 8$ V to 18 V, $-40^{\circ}\text{C} \leq T_J \leq +150^{\circ}\text{C}$		- (-5 %)	285	- (+5 %)	
	$V_{CSO1,2} = 2$ V, $I_{out1,2} = 200$ mA to 350 mA $V_{in} = 8$ V to 18 V, $-40^{\circ}\text{C} \leq T_J \leq +150^{\circ}\text{C}$		- (-5 %)	280	- (+5 %)	
CSO Current at no Load Current	$V_{CSO1,2} = 0$ V, $I_{out1,2} = 0$ mA	$I_{CSO\_off1,2}$	-	-	15	$\mu$ A

**REVERSE BIAS CURRENT**

Reverse Current	$V_{in} = 0$ V, $V_{out1,2} = 18$ V, $V_{EN1,2} = 0$ V	$I_{out\_rev1,2}$	-2	-0.03	-	mA
-----------------	--	-------------------	----	-------	---	----



**NCV47823**

**Table 7. ELECTRICAL CHARACTERISTICS**  $V_{in} = 13.5\text{ V}$ ,  $V_{EN1,2} = 3.3\text{ V}$ ,  $V_{DE} = 0\text{ V}$ ,  $R_{CSO1,2} = 0\ \Omega$ ,  $C_{in} = 1\ \mu\text{F}$ ,  $C_{out1,2} = 1\ \mu\text{F}$ , Min and Max values are valid for temperature range  $-40^{\circ}\text{C} \leq T_J \leq +150^{\circ}\text{C}$  unless noted otherwise and are guaranteed by test, design or statistical correlation. Typical values are referenced to  $T_J = 25^{\circ}\text{C}$  (Note 8)

Parameter	Test Conditions	Symbol	Min	Typ	Max	Unit
<b>DIAGNOSTICS</b>						
Short to Ground (STG) Voltage Threshold in ON State	$V_{in} = 4.4\text{ V to }18\text{ V}$ $R_{CSO1,2} = 3.3\text{ k}\Omega$	$V_{STG1,2}$	2	3	4	V
Short To Battery (STB) Voltage Threshold in OFF state	$V_{in} = 4.4\text{ V to }18\text{ V}$ , $I_{out1} = I_{out2} = 0\text{ mA}$ $V_{DE} = 3.3\text{ V}$	$V_{STB1,2}$	2	3	4	V
Open Load (OL) Current Threshold in OFF state	$V_{in} = 4.4\text{ V to }18\text{ V}$ , $V_{DE} = 3.3\text{ V}$	$I_{OL1,2}$	5.0	10	25	mA
Output Voltage to Output Feedback Voltage Ratio	$V_{in} = 4.4\text{ V to }18\text{ V}$	$V_{out1,2}/V_{out\_FB1,2}$	5.7	6.0	6.3	-
Diagnosics Enable Threshold Voltage Logic Low Logic High		$V_{th(DE)}$	0.99 -	1.8 1.9	- 2.31	V
Channel Select Threshold Voltage Logic Low Logic High		$V_{th(CS)}$	0.99 -	1.8 1.9	- 2.31	V
Error Flag Low Voltage	$I_{EF} = -1\text{ mA}$	$V_{EF\_Low}$	-	0.04	0.4	V
<b>THERMAL SHUTDOWN</b>						
Thermal Shutdown Temperature (Note 9)	$I_{out1} = I_{out2} = 90\text{ mA}$ , each channel measured separately	$T_{SD1,2}$	150	175	195	$^{\circ}\text{C}$

Product parametric performance is indicated in the Electrical Characteristics for the listed test conditions, unless otherwise noted. Product performance may not be indicated by the Electrical Characteristics if operated under different conditions.

8. Performance guaranteed over the indicated operating temperature range by design and/or characterization tested at  $T_A = T_J$ . Low duty cycle pulse techniques are used during testing to maintain the junction temperature as close to ambient as possible
9. Values based on design and/or characterization.

# NCV47823

## TYPICAL CHARACTERISTICS

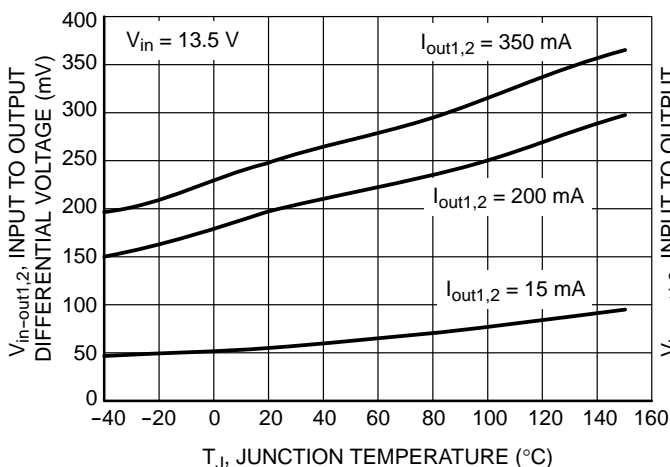

**Figure 4. Input to Output Differential Voltage vs. Temperature**

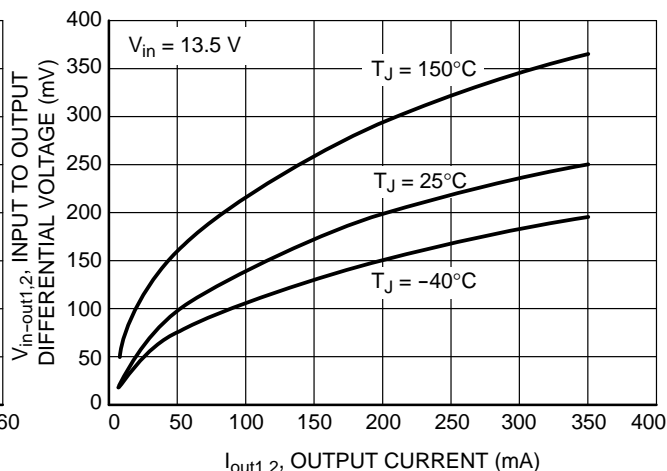

**Figure 5. Input to Output Differential Voltage vs. Output Current**

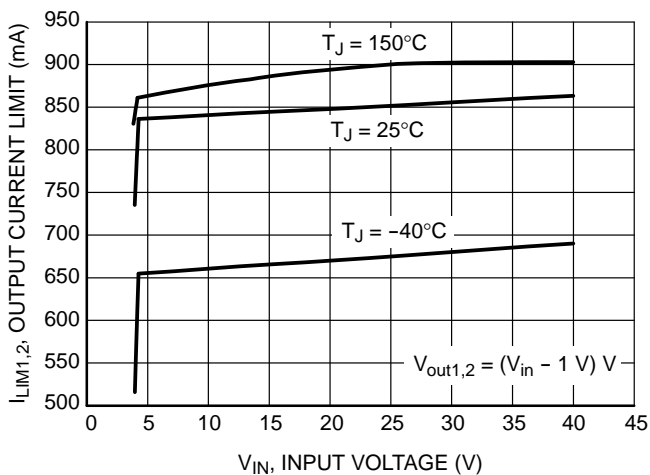

**Figure 6. Output Current Limit vs. Input Voltage**

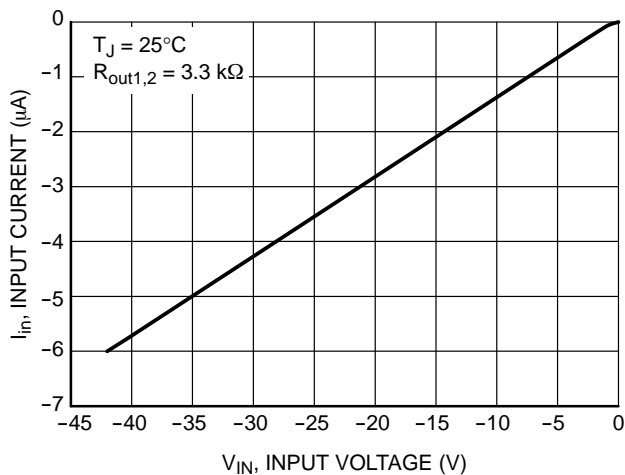

**Figure 7. Input Current vs. Input Voltage (Reverse Input Voltage)**

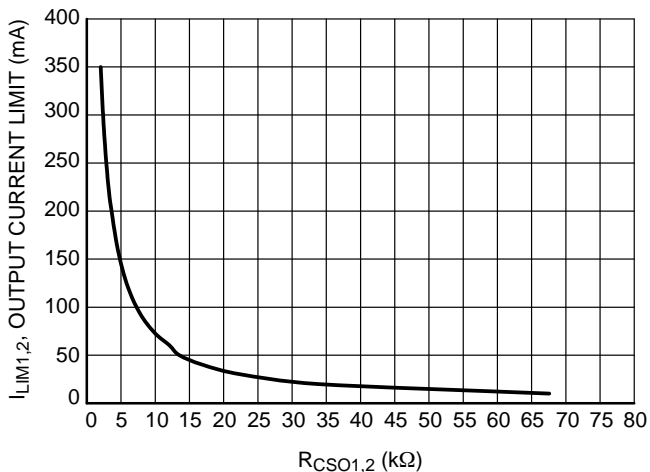

**Figure 8. Output Current Limit vs. R<sub>CSO</sub>**

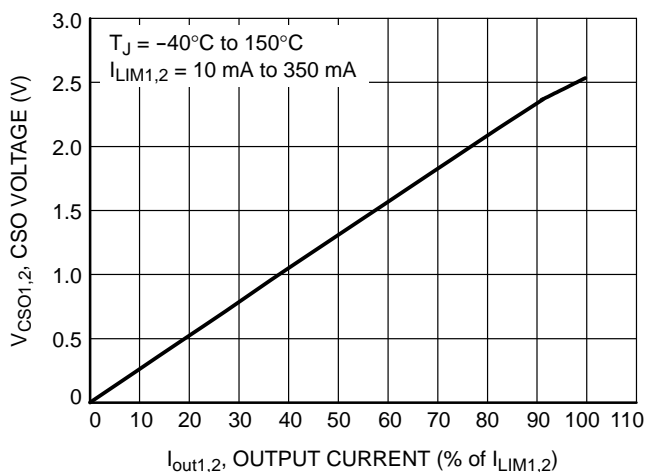

**Figure 9. CSO Voltage vs. Output Current (% of I<sub>LIM</sub>)**

# NCV47823

## TYPICAL CHARACTERISTICS

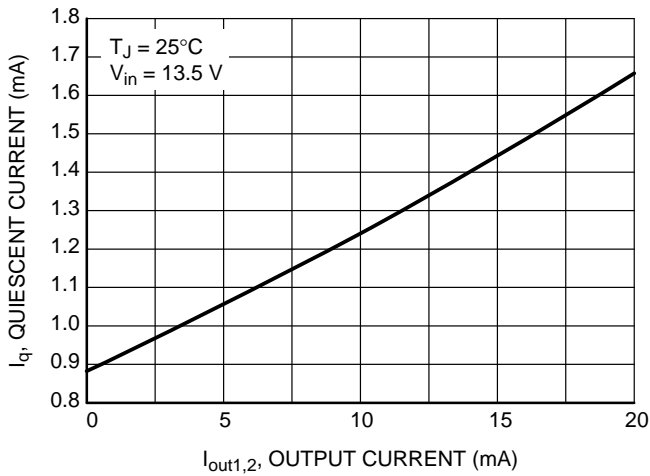

**Figure 10. Quiescent Current vs. Output Current (Low Load)**

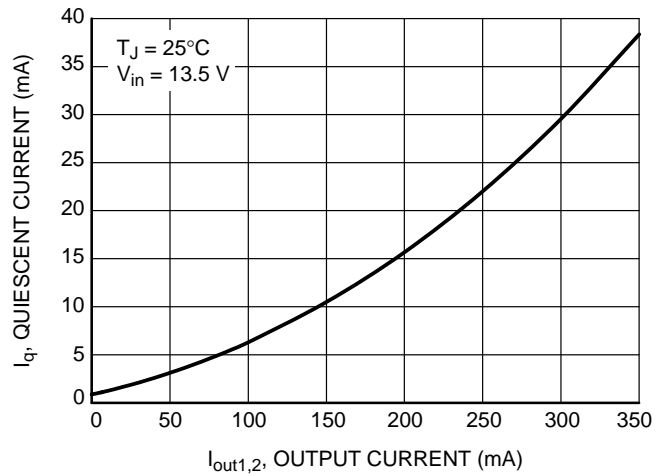

**Figure 11. Quiescent Current vs. Output Current (High Load)**

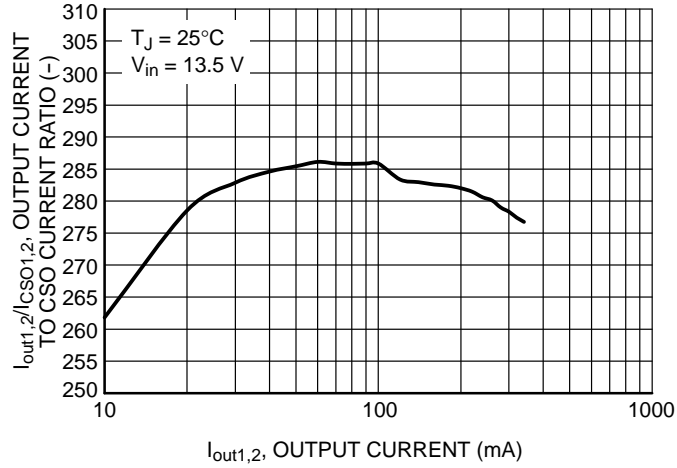

**Figure 12. Output Current to CSO Current Ratio vs. Output Current**

## NCV47823

### DEFINITIONS

#### General

All measurements are performed using short pulse low duty cycle techniques to maintain junction temperature as close as possible to ambient temperature.

#### Input to Output Differential Voltage

The Input to Output Differential Voltage parameter is defined for specific output current values and specified over Temperature range.

#### Quiescent and Disable Currents

Quiescent Current ( $I_Q$ ) is the difference between the input current (measured through the LDO input pin) and the output load current. If Enable pin is set to LOW the regulator reduces its internal bias and shuts off the output, this term is called the disable current ( $I_{DIS}$ ).

#### Current Limit

Current Limit is value of output current by which output voltage drops to or below  $V_{in} - 1$  V value.

#### Thermal Protection

Internal thermal shutdown circuitry is provided to protect the integrated circuit in the event that the maximum junction temperature is exceeded. When activated at typically 175°C, the regulator turns off. This feature is provided to prevent failures from accidental overheating.

#### Maximum Package Power Dissipation

The power dissipation level is maximum allowed power dissipation for particular package or power dissipation at which the junction temperature reaches its maximum operating value, whichever is lower.

## NCV47823

### APPLICATIONS INFORMATION

#### Circuit Description

The NCV47823 is an integrated dual High Side Switch (HSS) with current limit up to 350 mA per channel able to operate in Constant Current Source (CCS) mode depending on the output current load. The operation mode can be expressed by equations as follows:

$$\text{HSSmode} : \frac{(V_{in} - V_{in-out1,2})}{R_{load1,2}} = I_{out1,2} < I_{LIM1,2} \quad (\text{eq. 1})$$

or

$$\text{CCSmode} : \frac{(V_{in} - V_{in-out1,2})}{R_{load1,2}} = I_{out1,2} = I_{LIM1,2} \quad (\text{eq. 2})$$

where  $I_{LIM1,2}$  value is preset by  $R_{CSO1,2}$ . In HSS mode of operation (eq. 1) output current  $I_{out1,2}$  may exceed  $I_{LIM1,2}$  (reduced inrush current). Voltage on CSO pin is proportional to output current. The operation mode with PWM function of Enable inputs is provided by the circuit. The integrated current sense features diagnosis and system protection functionality. The HSS is protected by both current limit and thermal shutdown. Thermal shutdown occurs above 150°C to protect the IC during overloads and extreme ambient temperatures.

#### Enable Inputs

An enable pin is used to turn the channel on or off. By holding the pin down to a voltage less than 0.99 V, the output of the channel will be turned off. When the voltage on the enable pin is greater than 2.31 V, the output of the channel will be enabled to power its output to the regulated output voltage. The enable pins may be connected directly to the input pin to give constant enable to the output channel. As mentioned above, the circuit allows using both Enable inputs to obtain PWM of output current.

#### Setting the Output Current Limit

The output current value can be set up to 350 mA by external resistor  $R_{CSO1,2}$  (see Figure 1).

$$V_{CSO1,2} = I_{out1,2} \left( R_{CSO1,2} \times \frac{1}{\text{RATIO}} \right) \quad (\text{eq. 3})$$

$$I_{LIM1,2} = \frac{\text{RATIO}}{1} \times \frac{2.55}{R_{CSO1,2}} \quad (\text{eq. 4})$$

$$R_{CSO1,2} = \frac{\text{RATIO}}{1} \times \frac{2.55}{I_{LIM1,2}} \quad (\text{eq. 5})$$

where

$R_{CSO1,2}$  - current limit setting resistor

$V_{CSO1,2}$  - voltage at CSO pin proportional to  $I_{out1,2}$

$I_{LIM1,2}$  - current limit value

$I_{out1,2}$  - output current actual value

**RATIO** - typical value of Output Current to CSO Current Ratio for particular output current range

CSO pin provides information about output current actual value. The CSO voltage is proportional to output current according to (eq. 3).

Once output current reaches its limit value ( $I_{LIM1,2}$ ) set by external resistor  $R_{CSO}$  than voltage at CSO pin is typically 2.55 V. Calculations of  $I_{LIM1,2}$  or  $R_{CSO1,2}$  values can be done using (eq. 6) and (eq. 7).

$$I_{LIM1,2\_min} = \text{RATIO}_{min} \times \frac{V_{CSO1,2\_min}}{R_{CSO1,2\_max}} \quad (\text{eq. 6})$$

$$I_{LIM1,2\_max} = \text{RATIO}_{max} \times \frac{V_{CSO1,2\_max}}{R_{CSO1,2\_min}} \quad (\text{eq. 7})$$

where:

**RATIO<sub>min</sub>** - minimum value of Output Current to CSO Current Ratio from electrical characteristics table and particular output current range

**RATIO<sub>max</sub>** - maximum value of Output Current to CSO Current Ratio from electrical characteristics table and particular output current range

**$V_{CSO1,2\_min}$**  - minimum value of CSO Voltage Level at Current Limit from electrical characteristics table

**$V_{CSO1,2\_max}$**  - maximum value of CSO Voltage Level at Current Limit from electrical characteristics table

**$R_{CSO1,2\_min}$**  - minimum value of  $R_{CSO1,2}$  with respect its accuracy

**$R_{CSO1,2\_max}$**  - maximum value of  $R_{CSO1,2}$  with respect its accuracy

Designers should consider the tolerance of  $R_{CSO1,2}$  during the design phase.

## NCV47823

### Diagnostic in OFF state

The NCV47823 contains also circuitry for OFF state diagnostics for Short to Battery (STB) and Open Load (OL). There are internal current sources and Pull Down resistors providing additional cost savings for overall application by excluding external components and their assembly cost and saving PCB space and safe control IOs of a Microcontroller Unit (MCU). Simplified functional schematic and truth

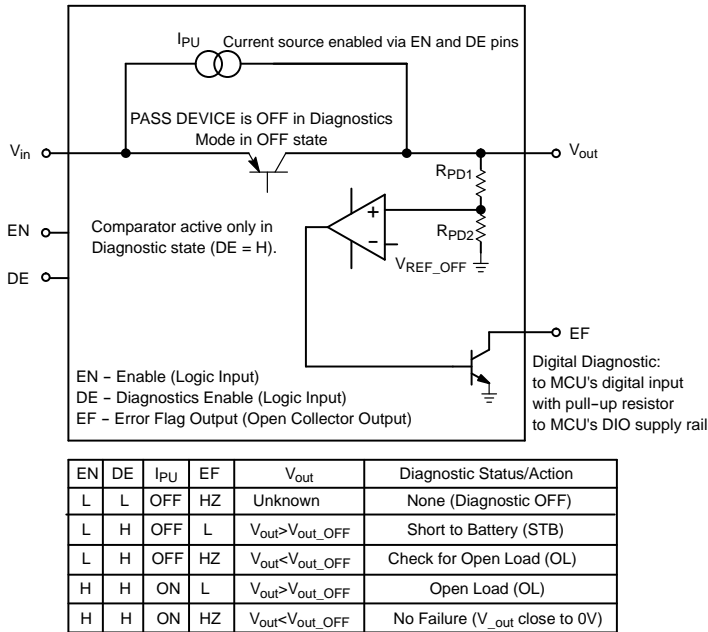

Figure 13. Simplified Functional Diagram of OFF State Diagnostics (STB and OL)

### Diagnostic in ON state

Diagnostic in ON State provides information about Overcurrent or Short to Ground failures, during which the EF output is in logic low state. The diagnostics in ON state shall be performed for each channel separately. For diagnostics of Channel 1 the input CS pin has to be put logic low, for diagnostics of Channel 2 the input CS pin has to be put logic high. For detailed information see Diagnostic Features Truth Table in Table 8.

table is shown in Figure 13 and related flowchart in Figure 14.

The diagnostics in OFF state shall be performed for each channel separately. For diagnostics of Channel 1 the input CS pin has to be put logic low, for diagnostics of Channel 2 the input CS pin has to be put logic high. Corresponding EN pin has to be used for control (EN1 for Channel 1 and EN2 for Channel 2).

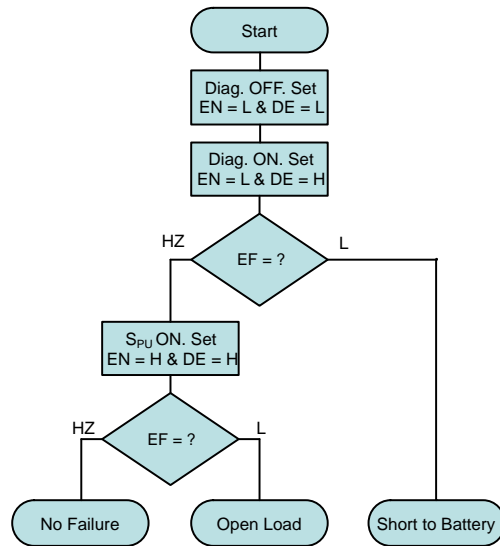

Figure 14. Flowchart for Diagnostics in OFF State

### Output Voltage Monitoring

The Output Voltage net is connected to internal resistor divider. Output of the resistor divider is connected to V<sub>out\_FB1,2</sub> pin and provides information about Output Voltage Level according to (eq. 8).

$$V_{out\_FB1,2} = \frac{V_{out1,2}}{6} \quad (\text{eq. 8})$$

# NCV47823

**Table 8. DIAGNOSTIC FEATURES TRUTH TABLE**

Operational Status	EN (note 10)	DE	CS	Output Channel (V <sub>out1</sub> or V <sub>out2</sub> )	Diagnostic Output (CSO1 or CSO2)	Error Flag (EF)
Disabled	L	L	X	Low (~0 V)	Low (~0 V)	HZ
Short to Battery (OFF)	L	H	L/H (Note 13)	High(V <sub>out</sub> ~V <sub>in</sub> )	Low (~0 V)	L (Note 11)
Open Load (OFF)	H	H	L/H (Note 13)	High(V <sub>out</sub> ~V <sub>in</sub> )	Low (~0 V)	L (Note 12)
Normal (OFF)	H	H	L/H (Note 13)	Low (~0 V)	Low (~0 V)	HZ (Note 12)
Open Load (ON)	H	L	L/H (Note 13)	High(V <sub>out</sub> ~V <sub>in</sub> )	Low (~0 V)	HZ
Switch	H	L	L/H (Note 13)	I <sub>out</sub> <I <sub>out_SET</sub>	Proportional to I <sub>out</sub> (± 5%) (Note 15)	HZ
Current Source	H	L	L/H (Note 13)	I <sub>out</sub> =I <sub>out_SET</sub>	High (~2.55 V)	HZ
Short to Ground	H	L	L/H (Note 13)	Low (~0 V)	High (~2.55 V)	L (Note 14)

10. State of EN pin of appropriate channel

11. Internal current source turned OFF (between V<sub>out</sub> and V<sub>in</sub> of appropriate channel)

12. Internal current source turned ON (between V<sub>out</sub> and V<sub>in</sub> of appropriate channel)

13. CS = L means CH1 diagnostics and CS = H means CH2 diagnostics (e.g. when CS = L and EF = L then failure at CH1 observed, when CS = H and EF = L then failure at CH2 observed)

14. STG is considered as fault when V<sub>out</sub> < 3 V

15. Valid for I<sub>out</sub> = 50 mA to 350 mA. For I<sub>out</sub> = 10 mA to 50 mA range proportional to I<sub>out</sub> (± 15%).

### Thermal Considerations

As power in the device increases, it might become necessary to provide some thermal relief. The maximum power dissipation supported by the device is dependent upon board design and layout. Mounting pad configuration on the PCB, the board material, and the ambient temperature affect the rate of junction temperature rise for the part. When the device has good thermal conductivity through the PCB, the junction temperature will be relatively low with high power applications. The maximum dissipation the device can handle is given by:

$$P_{D(MAX)} = \frac{[T_{J(MAX)} - T_A]}{R_{\theta JA}} \quad (\text{eq. 9})$$

Since T<sub>J</sub> is not recommended to exceed 150°C, then the device soldered on 645 mm<sup>2</sup>, 1 oz copper area, FR4 can dissipate up to 2.38 W when the ambient temperature (T<sub>A</sub>) is 25°C. See Figure 15 for R<sub>θJA</sub> versus PCB area. The power dissipated by the device can be calculated from the following equations:

(eq. 10)

$$P_D \approx V_{in}(I_q @ I_{out1,2}) + I_{out1}(V_{in} - V_{out1}) + I_{out2}(V_{in} - V_{out2})$$

or

$$V_{in(MAX)} \approx \frac{P_{D(MAX)} + (V_{out1} \times I_{out1}) + (V_{out2} \times I_{out2})}{I_{out1} + I_{out2} + I_q} \quad (\text{eq. 11})$$

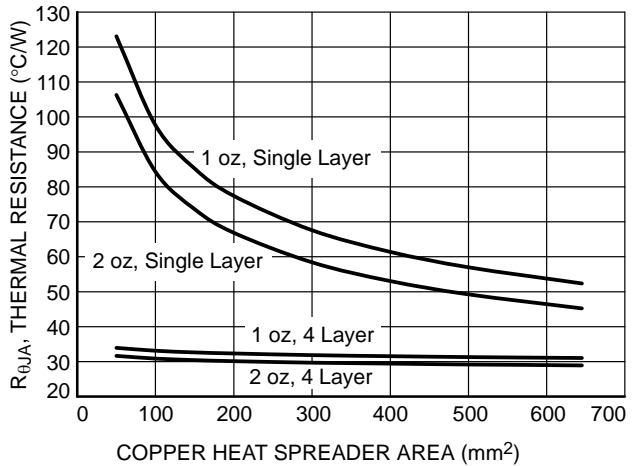

**Figure 15. Thermal Resistance vs. PCB Copper Area**

## NCV47823

### Hints

$V_{in}$  and GND printed circuit board traces should be as wide as possible. When the impedance of these traces is high, there is a chance to pick up noise or cause the regulator to malfunction. Place external components, especially the output capacitor, as close as possible to the device and make traces as short as possible.

The Output Voltage Monitoring Output is high impedance output (see Figure 2) and during OFF state diagnostics it may be prone to couple a noise via PCB track or wire. Disturbing may appear as Error Flag Output oscillation when Output Voltage Level is close to Short to Battery threshold. To improve robustness connect capacitor (typically 10 nF) between each  $V_{out\_FB1,2}$  pin and GND as close as possible to the  $V_{out\_FB1,2}$  pins.

The Current Sense Output is internally connected to an input of error amplifier and may be prone to couple a noise via long PCB track or wire (e.g. connection to an ADC). In

case of long PCB track or wire connected to CSO pin it is recommended to use RC filter for noise suppression (see Figure 16 and Table 9) in cost of higher inrush current. The R value of the RC filter can be higher than value listed in Table 9, depending on acceptable of RC time constant. The higher is R value the lower is inrush current. Value of C = 10 nF is optimized for noise suppression and as low as possible inrush current.

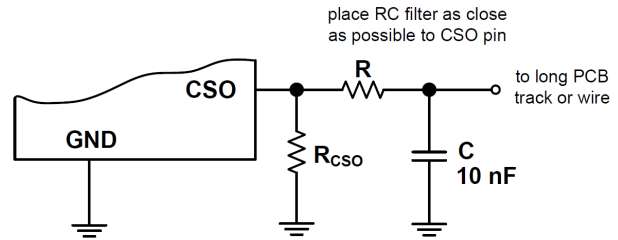

Figure 16. RF Filter Connection

**Table 9. INRUSH CURRENT AND RECOMMENDED RC VALUES**

(Test Conditions:  $V_{in} = 13.5\text{ V}$ ,  $V_{out} = \text{short to GND}$ ,  $V_{EN} = \text{pulse from } 0\text{ V to } 5\text{ V}$ )

Rcso (kΩ)	Calculated Current Limit (mA) (Note 16)	Inrush Current without RC (mA)	minimum R (kΩ)	C (nF)	Inrush Current with RC (mA) with minimum R
68	11	75	22	10	65
15	51	108	22	10	124
8.2	93	133	33	10	145
5.1	150	159	33	10	182
3.9	183	211	33	10	231
3.3	216	248	33	10	270
2.7	264	308	22	10	338
2.2	325	376	15	10	415

16. Calculated ILIM is for  $V_{out} = V_{in} - 1\text{ V}$ .

### ORDERING INFORMATION

Device	Marking	Package	Shipping†
NCV47823PAAJR2G	Line1: NCV4 Line2: 7823	TSSOP-14 EP (Pb-Free)	2500 / Tape & Reel

†For information on tape and reel specifications, including part orientation and tape sizes, please refer to our Tape and Reel Packaging Specifications Brochure, [BRD8011/D](#).



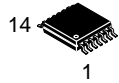

**TSSOP-14 EP**  
**CASE 948AW**  
**ISSUE C**

DATE 09 OCT 2012

SCALE 1:1

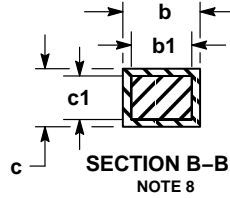
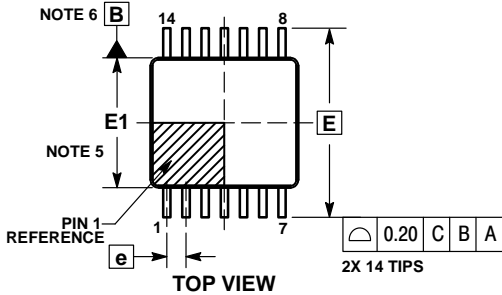

**NOTES:**

1. DIMENSIONING AND TOLERANCING PER ASME Y14.5M, 1994.
2. CONTROLLING DIMENSION: MILLIMETERS.
3. DIMENSION b DOES NOT INCLUDE DAMBAR PROTRUSION. ALLOWABLE PROTRUSION SHALL BE 0.07 mm MAX. AT MAXIMUM MATERIAL CONDITION. DAMBAR CANNOT BE LOCATED ON THE LOWER RADIUS OF THE FOOT. MINIMUM SPACE BETWEEN PROTRUSION AND ADJACENT LEAD IS 0.07.
4. DIMENSION D DOES NOT INCLUDE MOLD FLASH, PROTRUSIONS OR GATE BURRS. MOLD FLASH, PROTRUSIONS OR GATE BURRS SHALL NOT EXCEED 0.15 mm PER SIDE. DIMENSION D IS DETERMINED AT DATUM H.
5. DIMENSION E1 DOES NOT INCLUDE INTERLEAD FLASH OR PROTRUSIONS. INTERLEAD FLASH OR PROTRUSIONS SHALL NOT EXCEED 0.25 mm PER SIDE. DIMENSION E1 IS DETERMINED AT DATUM H.
6. DATUMS A AND B ARE DETERMINED AT DATUM H.
7. A1 IS DEFINED AS THE VERTICAL DISTANCE FROM THE SEATING PLANE TO THE LOWEST POINT ON THE PACKAGE BODY.
8. SECTION B-B TO BE DETERMINED AT 0.10 TO 0.25 mm FROM THE LEAD TIP.

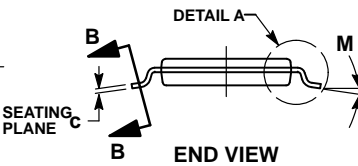
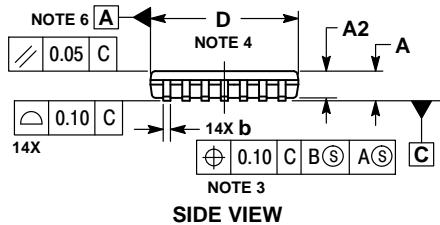

MILLIMETERS		
DIM	MIN	MAX
A	---	1.20
A1	0.05	0.15
A2	0.80	1.05
b	0.19	0.30
b1	0.19	0.25
c	0.09	0.20
c1	0.09	0.16
D	4.90	5.10
D2	3.09	3.62
E	6.40 BSC	
E1	4.30	4.50
E2	2.69	3.22
e	0.65 BSC	
L	0.45	0.75
L2	0.25 BSC	
M	0°	8°

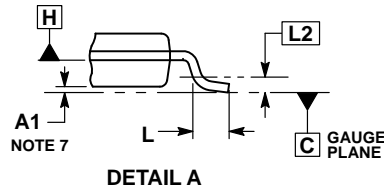
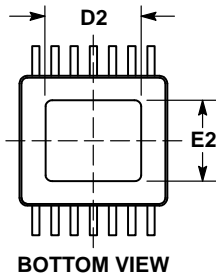

**RECOMMENDED SOLDERING FOOTPRINT\***

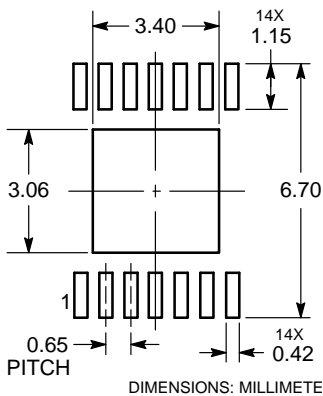

**GENERIC MARKING DIAGRAM\***

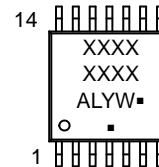

- XXXX = Specific Device Code
- A = Assembly Location
- L = Wafer Lot
- Y = Year
- W = Work Week
- = Pb-Free Package

(Note: Microdot may be in either location)

\*This information is generic. Please refer to device data sheet for actual part marking. Pb-Free indicator, "G" or microdot "▪", may or may not be present.

\*For additional information on our Pb-Free strategy and soldering details, please download the onsemi Soldering and Mounting Techniques Reference Manual, SOLDERRM/D.

<b>DOCUMENT NUMBER:</b>	<b>98AON66474E</b>	Electronic versions are uncontrolled except when accessed directly from the Document Repository. Printed versions are uncontrolled except when stamped "CONTROLLED COPY" in red.
<b>DESCRIPTION:</b>	<b>TSSOP-14 EP, 5.0X4.4</b>	<b>PAGE 1 OF 1</b>

onsemi and ONSEMI are trademarks of Semiconductor Components Industries, LLC dba onsemi or its subsidiaries in the United States and/or other countries. onsemi reserves the right to make changes without further notice to any products herein. onsemi makes no warranty, representation or guarantee regarding the suitability of its products for any particular purpose, nor does onsemi assume any liability arising out of the application or use of any product or circuit, and specifically disclaims any and all liability, including without limitation special, consequential or incidental damages. onsemi does not convey any license under its patent rights nor the rights of others.

**onsemi**, **Onsemi**, and other names, marks, and brands are registered and/or common law trademarks of Semiconductor Components Industries, LLC dba "**onsemi**" or its affiliates and/or subsidiaries in the United States and/or other countries. **onsemi** owns the rights to a number of patents, trademarks, copyrights, trade secrets, and other intellectual property. A listing of **onsemi**'s product/patent coverage may be accessed at [www.onsemi.com/site/pdf/Patent-Marking.pdf](http://www.onsemi.com/site/pdf/Patent-Marking.pdf). **onsemi** reserves the right to make changes at any time to any products or information herein, without notice. The information herein is provided "as-is" and **onsemi** makes no warranty, representation or guarantee regarding the accuracy of the information, product features, availability, functionality, or suitability of its products for any particular purpose, nor does **onsemi** assume any liability arising out of the application or use of any product or circuit, and specifically disclaims any and all liability, including without limitation special, consequential or incidental damages. Buyer is responsible for its products and applications using **onsemi** products, including compliance with all laws, regulations and safety requirements or standards, regardless of any support or applications information provided by **onsemi**. "Typical" parameters which may be provided in **onsemi** data sheets and/or specifications can and do vary in different applications and actual performance may vary over time. All operating parameters, including "Typicals" must be validated for each customer application by customer's technical experts. **onsemi** does not convey any license under any of its intellectual property rights nor the rights of others. **onsemi** products are not designed, intended, or authorized for use as a critical component in life support systems or any FDA Class 3 medical devices or medical devices with a same or similar classification in a foreign jurisdiction or any devices intended for implantation in the human body. Should Buyer purchase or use **onsemi** products for any such unintended or unauthorized application, Buyer shall indemnify and hold **onsemi** and its officers, employees, subsidiaries, affiliates, and distributors harmless against all claims, costs, damages, and expenses, and reasonable attorney fees arising out of, directly or indirectly, any claim of personal injury or death associated with such unintended or unauthorized use, even if such claim alleges that **onsemi** was negligent regarding the design or manufacture of the part. **onsemi** is an Equal Opportunity/Affirmative Action Employer. This literature is subject to all applicable copyright laws and is not for resale in any manner.

#### ADDITIONAL INFORMATION

**TECHNICAL PUBLICATIONS:**

Technical Library: [www.onsemi.com/design/resources/technical-documentation](http://www.onsemi.com/design/resources/technical-documentation)  
onsemi Website: [www.onsemi.com](http://www.onsemi.com)

**ONLINE SUPPORT:** [www.onsemi.com/support](http://www.onsemi.com/support)

For additional information, please contact your local Sales Representative at [www.onsemi.com/support/sales](http://www.onsemi.com/support/sales)

## OUR CERTIFICATE

DiGi provide top-quality products and perfect service for customer worldwide through standardization, technological innovation and continuous improvement. DiGi through third-party certification, we strictly control the quality of products and services. Welcome your RFQ to

Email: [Info@DiGi-Electronics.com](mailto:Info@DiGi-Electronics.com)



Tel: +00 852-30501935

RFQ Email: [Info@DiGi-Electronics.com](mailto:Info@DiGi-Electronics.com)

DiGi is a global authorized distributor of electronic components.