

# PN2907ATFR Datasheet

[www.digi-electronics.com](http://www.digi-electronics.com)



<https://www.DiGi-Electronics.com>

|                              |  |
|------------------------------|--|
| DiGi Electronics Part Number | PN2907ATFR-DG  |
| Manufacturer                 | <a href="#">onsemi</a>   |
| Manufacturer Product Number  | PN2907ATFR   |
| Description                  | TRANS PNP 60V 0.8A TO92-3  |
| Detailed Description         | Bipolar (BJT) Transistor PNP 60 V 800 mA 200MHz 6 25 mW Through Hole TO-92-3 |



Tel: +00 852-30501935

RFQ Email: [Info@DiGi-Electronics.com](mailto:Info@DiGi-Electronics.com)

DiGi is a global authorized distributor of electronic components.

## Purchase and inquiry

Manufacturer Product Number:

PN2907ATFR

Series:

-

Transistor Type:

PNP

Voltage - Collector Emitter Breakdown (Max):

60 V

Current - Collector Cutoff (Max):

20nA (ICBO)

Power - Max:

625 mW

Operating Temperature:

-55°C ~ 150°C (TJ)

Package / Case:

TO-226-3, TO-92-3 (TO-226AA) Formed Leads

Base Product Number:

PN2907

Manufacturer:

onsemi

Product Status:

Active

Current - Collector (Ic) (Max):

800 mA

Vce Saturation (Max) @ Ib, Ic:

1.6V @ 50mA, 500mA

DC Current Gain (hFE) (Min) @ Ic, Vce:

100 @ 150mA, 10V

Frequency - Transition:

200MHz

Mounting Type:

Through Hole

Supplier Device Package:

TO-92-3

## Environmental & Export classification

RoHS Status:

ROHS3 Compliant

REACH Status:

REACH Unaffected

HTSUS:

8541.21.0075

Moisture Sensitivity Level (MSL):

Not Applicable

ECCN:

EAR99



# ON Semiconductor

## Is Now

The logo for onsemi, featuring the word "onsemi" in a dark teal, lowercase, sans-serif font. The letter "i" is stylized with a white dot and a teal vertical bar. A small orange triangle is positioned above the top right of the "i". A trademark symbol (TM) is located to the right of the logo.

To learn more about onsemi™, please visit our website at  
[www.onsemi.com](http://www.onsemi.com)

---

**onsemi** and **onsemi** and other names, marks, and brands are registered and/or common law trademarks of Semiconductor Components Industries, LLC dba "**onsemi**" or its affiliates and/or subsidiaries in the United States and/or other countries. **onsemi** owns the rights to a number of patents, trademarks, copyrights, trade secrets, and other intellectual property. A listing of **onsemi** product/patent coverage may be accessed at [www.onsemi.com/site/pdf/Patent-Marking.pdf](http://www.onsemi.com/site/pdf/Patent-Marking.pdf). **onsemi** reserves the right to make changes at any time to any products or information herein, without notice. The information herein is provided "as-is" and **onsemi** makes no warranty, representation or guarantee regarding the accuracy of the information, product features, availability, functionality, or suitability of its products for any particular purpose, nor does **onsemi** assume any liability arising out of the application or use of any product or circuit, and specifically disclaims any and all liability, including without limitation special, consequential or incidental damages. Buyer is responsible for its products and applications using **onsemi** products, including compliance with all laws, regulations and safety requirements or standards, regardless of any support or applications information provided by **onsemi**. "Typical" parameters which may be provided in **onsemi** data sheets and/or specifications can and do vary in different applications and actual performance may vary over time. All operating parameters, including "Typicals" must be validated for each customer application by customer's technical experts. **onsemi** does not convey any license under any of its intellectual property rights nor the rights of others. **onsemi** products are not designed, intended, or authorized for use as a critical component in life support systems or any FDA Class 3 medical devices or medical devices with a same or similar classification in a foreign jurisdiction or any devices intended for implantation in the human body. Should Buyer purchase or use **onsemi** products for any such unintended or unauthorized application, Buyer shall indemnify and hold **onsemi** and its officers, employees, subsidiaries, affiliates, and distributors harmless against all claims, costs, damages, and expenses, and reasonable attorney fees arising out of, directly or indirectly, any claim of personal injury or death associated with such unintended or unauthorized use, even if such claim alleges that **onsemi** was negligent regarding the design or manufacture of the part. **onsemi** is an Equal Opportunity/Affirmative Action Employer. This literature is subject to all applicable copyright laws and is not for resale in any manner. Other names and brands may be claimed as the property of others.



ON Semiconductor®

## PN2907A / MMBT2907A / PZT2907A 60 V PNP General-Purpose Transistor

### Features

- High DC Current Gain ( $h_{FE}$ ) Range: 100 ~ 300
- High-Current Gain Bandwidth Product ( $f_T$ ): 200 MHz (Minimum)
- Maximum Turn-On Time ( $t_{on}$ ): 45 ns
- Maximum Turn-Off Time ( $t_{off}$ ): 100 ns
- Ultra-Small Surface-Mount Package: SOT-223 (PZT2907A)

### Applications

- General-Purpose Amplifier
- Switch

### Description

The PN2907A, MMBT2907A, and PZT2907A are 60 V PNP bipolar transistors designed for use as a general-purpose amplifier or switch in applications that require up to 500 mA. Offered in an ultra-small surface-mount package (SOT-223), the PZT2907A is ideal for space-constrained systems. The NPN complementary types are the PN2222A, MMBT2222A, and PZT2222A; respectively.

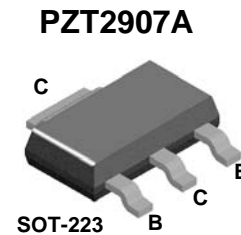
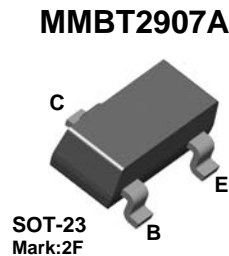

### Ordering Information

| Part Number    | Top Mark | Package    | Packing Method |
|----------------|----------|------------|----------------|
| PN2907ABU      | 2907A    | TO-92 3L   | Bulk           |
| PN2907ATF      | 2907A    | TO-92 3L   | Tape and Reel  |
| PN2907ATFR     | 2907A    | TO-92 3L   | Tape and Reel  |
| PN2907ATA      | 2907A    | TO-92 3L   | Ammo           |
| PN2907ATAR     | 2907A    | TO-92 3L   | Ammo           |
| MMBT2907A      | 2F       | SOT-23 3L  | Tape and Reel  |
| MMBT2907A-D87Z | 2F       | SOT-23 3L  | Tape and Reel  |
| PZT2907A       | 2907A    | SOT-223 4L | Tape and Reel  |

PN2907A / MMBT2907A / PZT2907A — 60 V PNP General-Purpose Transistor

## Absolute Maximum Ratings<sup>(1),(2)</sup>

Stresses exceeding the absolute maximum ratings may damage the device. The device may not function or be operable above the recommended operating conditions and stressing the parts to these levels is not recommended. In addition, extended exposure to stresses above the recommended operating conditions may affect device reliability. The absolute maximum ratings are stress ratings only. Values are at  $T_A = 25^\circ\text{C}$  unless otherwise noted.

| Symbol         | Parameter  | Value       | Unit             |
|----------------|--|-------------|------------------|
| $V_{CEO}$      | Collector-Emitter Voltage                        | -60         | V                |
| $V_{CBO}$      | Collector-Base Voltage                           | -60         | V                |
| $V_{EBO}$      | Emitter-Base Voltage                             | -5.0        | V                |
| $I_C$          | Collector Current - Continuous                   | -800        | mA               |
| $T_J, T_{STG}$ | Operating and Storage Junction Temperature Range | -55 to +150 | $^\circ\text{C}$ |

### Notes:

1. These ratings are based on a maximum junction temperature of  $150^\circ\text{C}$ .
2. These are steady-state limits. ON Semiconductor should be consulted on applications involving pulsed or low-duty cycle operations.

## Thermal Characteristics

Values are at  $T_A = 25^\circ\text{C}$  unless otherwise noted.

| Symbol          | Parameter                               | Max.                   |                          |                         | Unit                      |
|-----------------|---|------------------------|--------------------------|-------------------------|---------------------------|
|                 |   | PN2907A <sup>(4)</sup> | MMBT2907A <sup>(3)</sup> | PZT2907A <sup>(4)</sup> |                           |
| $P_D$           | Total Device Dissipation                | 625                    | 350                      | 1000                    | mW                        |
|                 | Derate Above $25^\circ\text{C}$         | 5.0                    | 2.8                      | 8.0                     | mW/ $^\circ\text{C}$      |
| $R_{\theta JC}$ | Thermal Resistance, Junction to Case    | 83.3                   |                          |                         | $^\circ\text{C}/\text{W}$ |
| $R_{\theta JA}$ | Thermal Resistance, Junction to Ambient | 200                    | 357                      | 125                     | $^\circ\text{C}/\text{W}$ |

### Notes:

3. Device is mounted on FR-4 PCB 1.6 inch X 1.6 inch X 0.06 inch.
4. PCB size: FR-4 76 x 114 x 1.57 mm<sup>3</sup> (3.0 inch x 4.5 inch x 0.062 inch) with minimum land pattern size.

## Electrical Characteristics

Values are at  $T_A = 25^\circ\text{C}$  unless otherwise noted.

| Symbol                              | Parameter   | Conditions   | Min. | Max.  | Unit          |
|-------------------------------------|---|--|------|-------|---------------|
| <b>Off Characteristics</b>          |   |  |      |       |               |
| $V_{(BR)CEO}$                       | Collector-Emitter Breakdown Voltage <sup>(5)</sup>  | $I_C = -10\text{ mA}, I_B = 0$   | -60  |       | V             |
| $V_{(BR)CBO}$                       | Collector-Base Breakdown Voltage                    | $I_C = -10\text{ }\mu\text{A}, I_E = 0$  | -60  |       | V             |
| $V_{(BR)EBO}$                       | Emitter-Base Breakdown Voltage                      | $I_E = -10\text{ }\mu\text{A}, I_C = 0$  | -5.0 |       | V             |
| $I_{BL}$                            | Base Cut-Off Current                                | $V_{CE} = -30\text{ V}, V_{EB} = -0.5\text{ V}$                                      |      | -50   | nA            |
| $I_{CEX}$                           | Collector Cut-Off Current                           | $V_{CE} = -30\text{ V}, V_{EB} = -0.5\text{ V}$                                      |      | -50   | nA            |
| $I_{CBO}$                           | Collector Cut-Off Current                           | $V_{CB} = -50\text{ V}, I_E = 0$   |      | -0.02 | $\mu\text{A}$ |
|                                     |   | $V_{CB} = -50\text{ V}, I_E = 0, T_A = 150^\circ\text{C}$                            |      | -20   |               |
| <b>On Characteristics</b>           |   |  |      |       |               |
| $h_{FE}$                            | DC Current Gain                                     | $I_C = -0.1\text{ mA}, V_{CE} = -10\text{ V}$  | 75   |       |               |
|                                     |   | $I_C = -1.0\text{ mA}, V_{CE} = -10\text{ V}$  | 100  |       |               |
|                                     |   | $I_C = -10\text{ mA}, V_{CE} = -10\text{ V}$   | 100  |       |               |
|                                     |   | $I_C = -150\text{ mA}, V_{CE} = -10\text{ V}^{(5)}$                                  | 100  | 300   |               |
|                                     |   | $I_C = -500\text{ mA}, V_{CE} = -10\text{ V}^{(5)}$                                  | 50   |       |               |
| $V_{CE(sat)}$                       | Collector-Emitter Saturation Voltage <sup>(5)</sup> | $I_C = -150\text{ mA}, I_B = -15\text{ mA}$  |      | -0.4  | V             |
|                                     |   | $I_C = -500\text{ mA}, I_B = -50\text{ mA}$  |      | -1.6  |               |
| $V_{BE(sat)}$                       | Base-Emitter Saturation Voltage                     | $I_C = -150\text{ mA}, I_B = -15\text{ mA}^{(5)}$                                    |      | -1.3  | V             |
|                                     |   | $I_C = -500\text{ mA}, I_B = -50\text{ mA}$  |      | -2.6  |               |
| <b>Small Signal Characteristics</b> |   |  |      |       |               |
| $f_T$                               | Current Gain - Bandwidth Product                    | $I_C = -50\text{ mA}, V_{CE} = -20\text{ V},$<br>$f = 100\text{ MHz}$                | 200  |       | MHz           |
| $C_{ob}$                            | Output Capacitance                                  | $V_{CB} = -10\text{ V}, I_E = 0,$<br>$f = 100\text{ kHz}$                            |      | 8.0   | pF            |
| $C_{ib}$                            | Input Capacitance                                   | $V_{EB} = -2.0\text{ V}, I_C = 0, f = 100\text{ kHz}$                                |      | 30    | pF            |
| <b>Switching Characteristics</b>    |   |  |      |       |               |
| $t_{on}$                            | Turn-On Time  | $V_{CC} = -30\text{ V}, I_C = -150\text{ mA},$<br>$I_{B1} = -15\text{ mA}$           |      | 45    | ns            |
| $t_d$                               | Delay Time  |  |      | 10    | ns            |
| $t_r$                               | Rise Time   |  |      | 40    | ns            |
| $t_{off}$                           | Turn-Off Time                                       | $V_{CC} = -6.0\text{ V}, I_C = -150\text{ mA},$<br>$I_{B1} = I_{B2} = -15\text{ mA}$ |      | 100   | ns            |
| $t_s$                               | Storage Time  |  |      | 80    | ns            |
| $t_f$                               | Fall Time   |  |      | 30    | ns            |

### Notes:

5. Pulse test: pulse width  $\leq 300\text{ }\mu\text{s}$ , duty cycle  $\leq 2.0\%$ .

### Typical Performance Characteristics

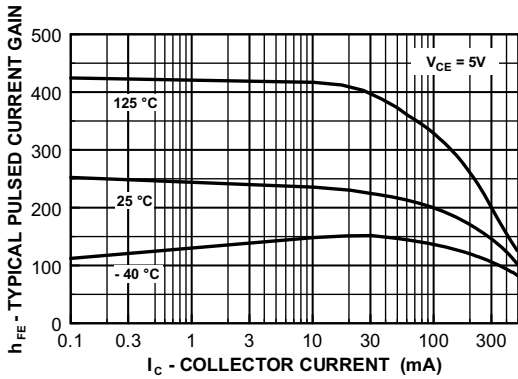

Figure 1. Typical Pulsed Current Gain vs. Collector Current

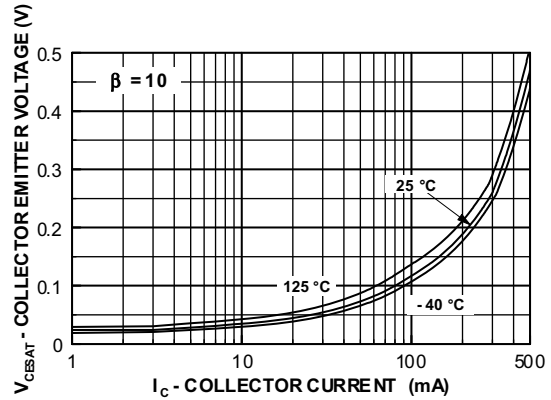

Figure 2. Collector-Emitter Saturation Voltage vs. Collector Current

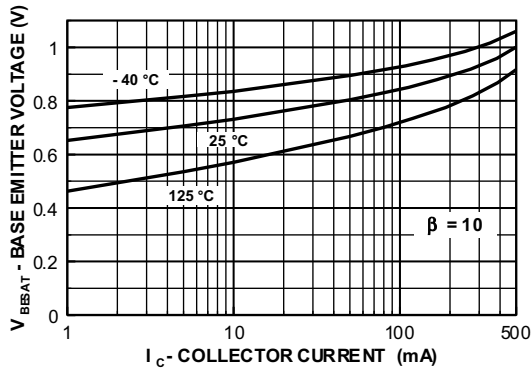

Figure 3. Base-Emitter Saturation Voltage vs. Collector Current

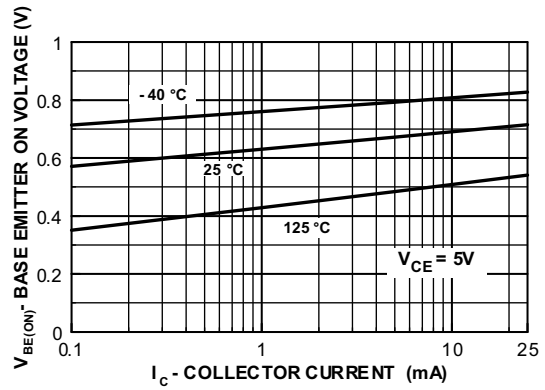

Figure 4. Base-Emitter On Voltage vs. Collector Current

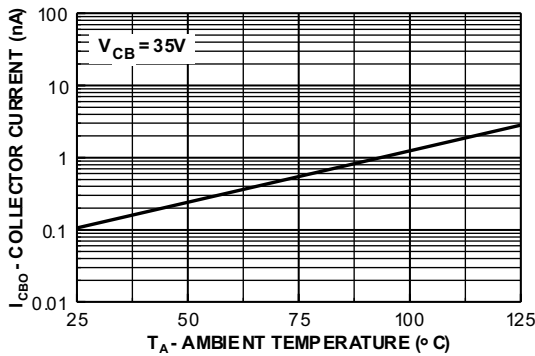

Figure 5. Collector Cut-Off Current vs. Ambient Temperature

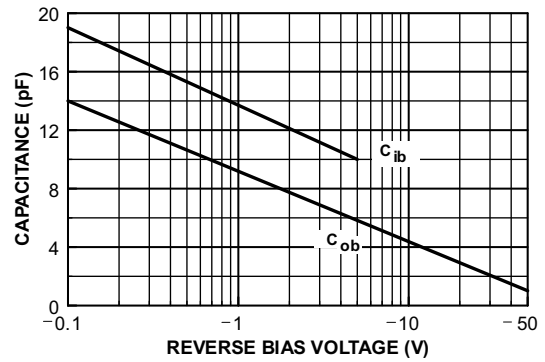

Figure 6. Input and Output Capacitance vs. Reverse Bias Voltage

Typical Performance Characteristics (Continued)

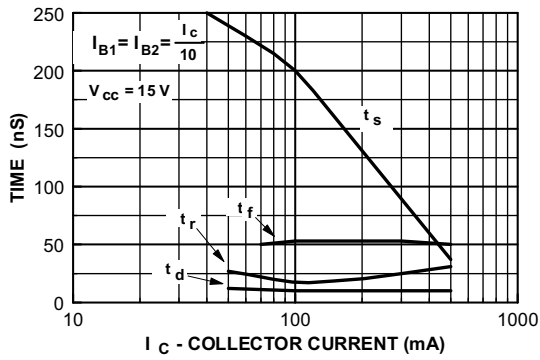

Figure 7. Switching Times vs. Collector Current

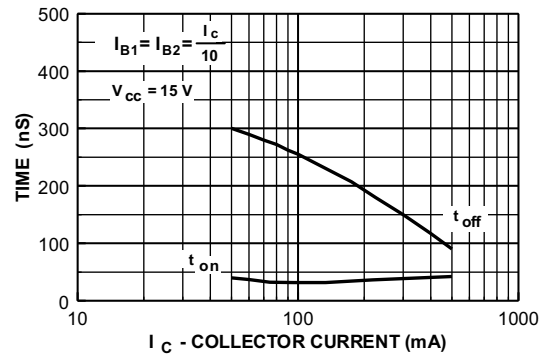

Figure 8. Turn-On and Turn-Off Times vs. Collector Current

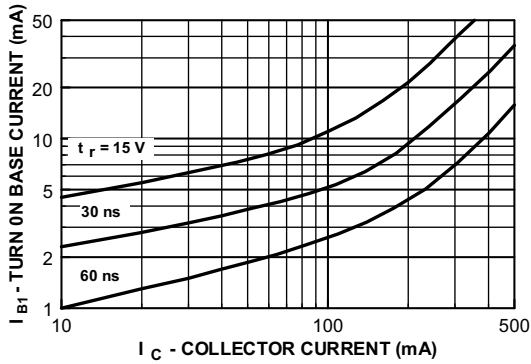

Figure 9. Rise Time vs. Collector and Turn-On Base Currents

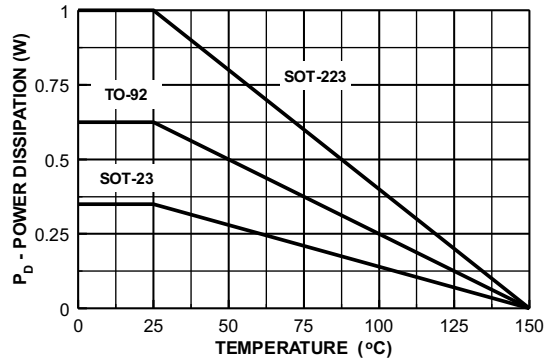

Figure 10. Power Dissipation vs. Ambient Temperature



Typical Performance Characteristics (f = 1.0 kHz)

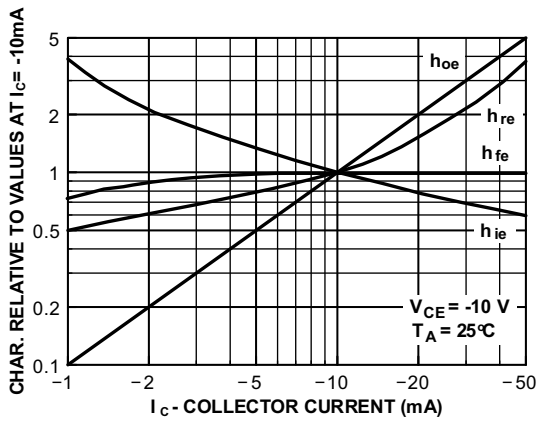

Figure 11. Common Emitter Characteristics

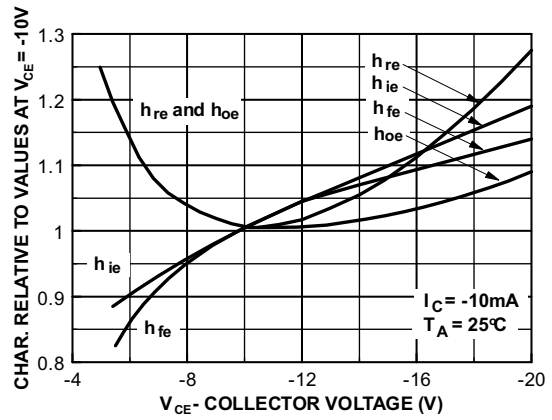

Figure 12. Common Emitter Characteristics

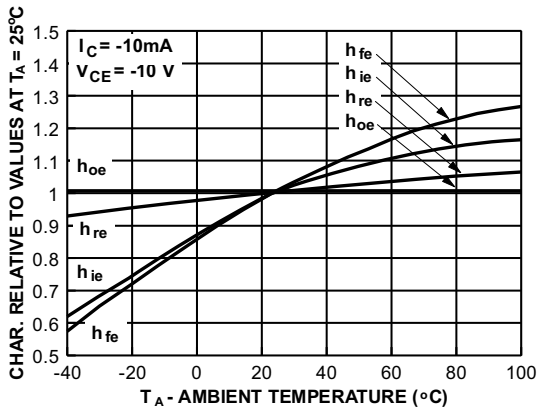
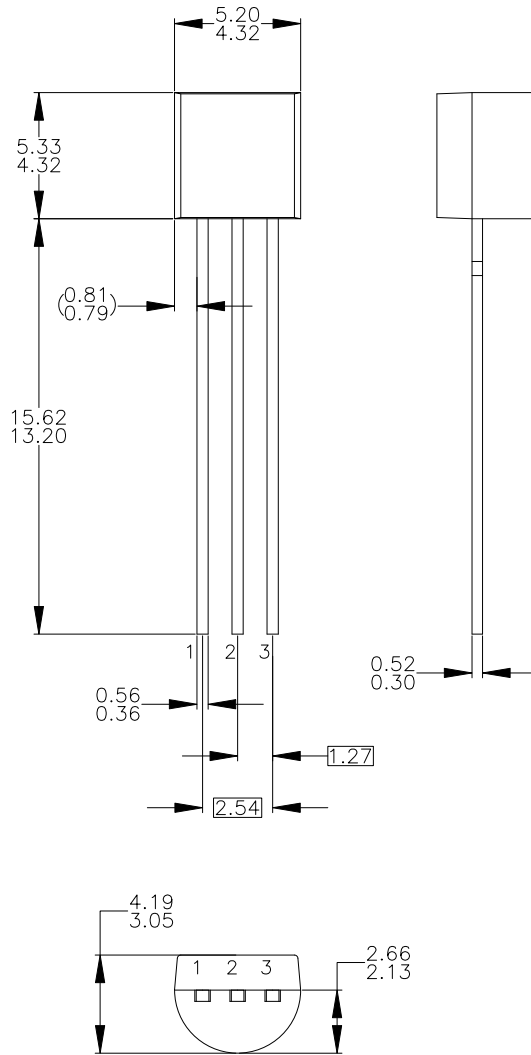

Figure 13. Common Emitter Characteristics

Physical Dimensions

TO-92 (Bulk)



NOTES: UNLESS OTHERWISE SPECIFIED

- A) DRAWING WITH REFERENCE TO JEDEC TO-92 RECOMMENDATIONS.
- B) ALL DIMENSIONS ARE IN MILLIMETERS.
- C) DRAWING CONFORMS TO ASME Y14.5M-1994.
- D) TO-92 (92,94,96,97,98) PIN CONFIGURATION:

| PIN | 92 |   |   | 94 |   |   | 96 |   |   | 97 |   |   | 98 |   |   |
|-----|----|---|---|----|---|---|----|---|---|----|---|---|----|---|---|
|     | P  | F | M | P  | F | M | B  | F | M | P  | F | M | P  | F | M |
| 1   | E  | S | S | E  | S | S | B  | D | G | C  | G | D | C  | G | D |
| 2   | B  | D | G | C  | G | D | E  | S | S | B  | D | G | E  | S | S |
| 3   | C  | G | D | B  | D | G | C  | G | D | E  | S | S | B  | D | G |

LEGEND:

- P - BIPOLAR
- F - JFET
- M - DMOS
- E - EMITTER
- B - BASE
- C - COLLECTOR
- D - DRAIN
- S - SOURCE
- G - GATE

- E) FOR PACKAGE 92, 94, 96, 97 AND 98: PIN CONFIGURATION DRAIN "D" AND SOURCE "S" ARE INTERCHANGEABLE AT JFET "F" OPTION.
- F) DRAWING FILENAME: MKT-ZA03DREV3.

Figure 14. 3-LEAD, TO92, JEDEC TO-92 COMPLIANT STRAIGHT LEAD CONFIGURATION (OLD TO92AM3) (ACTIVE)

Package drawings are provided as a service to customers considering ON Semiconductor components. Drawings may change in any manner without notice. Please note the revision and/or date on the drawing and contact a ON Semiconductor representative to verify or obtain the most recent revision. Package specifications do not expand the terms of ON Semiconductor's worldwide terms and conditions, specifically the warranty therein, which covers ON Semiconductor products.

**Physical Dimensions** (Continued)

**TO-92 (Tape and Reel, Ammo)**

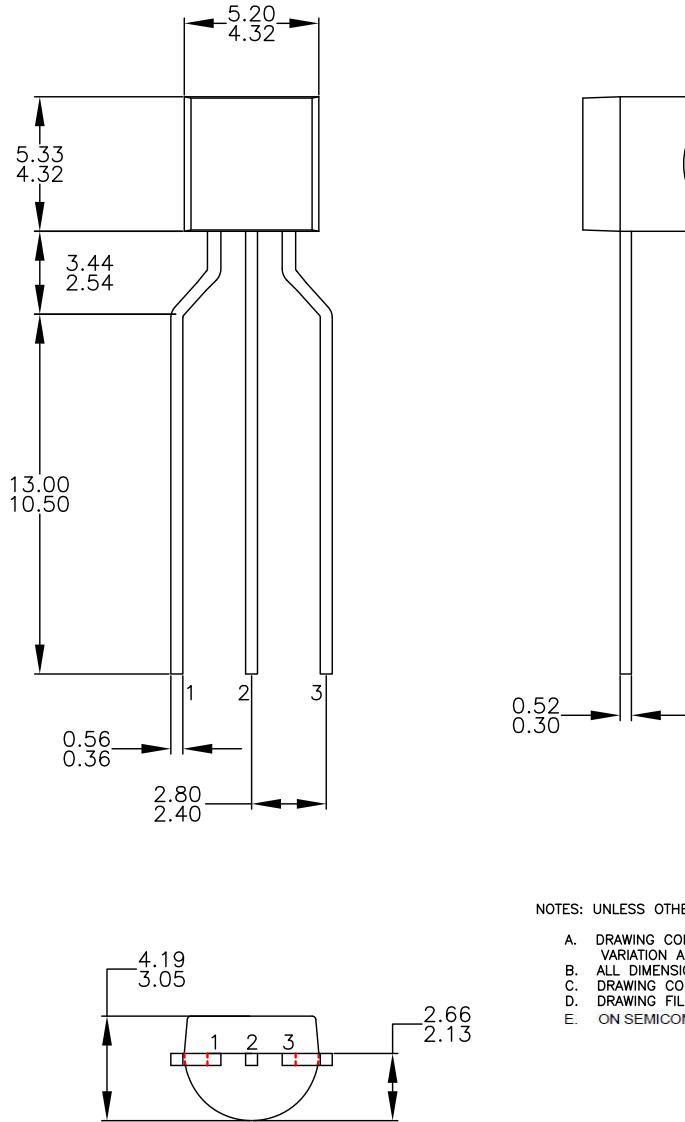

NOTES: UNLESS OTHERWISE SPECIFIED

- A. DRAWING CONFORMS TO JEDEC MS-013, VARIATION AC.
- B. ALL DIMENSIONS ARE IN MILLIMETERS.
- C. DRAWING CONFORMS TO ASME Y14.5M-2009.
- D. DRAWING FILENAME: MKT-ZA03FREV3.
- E. ON SEMICONDUCTOR

**Figure 15. 3-LEAD, TO92, MOLDED 0.200 IN LINE SPACING LEAD FORM (J61Z OPTION) (ACTIVE)**

Package drawings are provided as a service to customers considering ON Semiconductor components. Drawings may change in any manner without notice. Please note the revision and/or date on the drawing and contact a ON Semiconductor representative to verify or obtain the most recent revision. Package specifications do not expand the terms of ON Semiconductor's worldwide terms and conditions, specifically the warranty therein, which covers ON Semiconductor products.

Physical Dimensions (Continued)

SOT-23

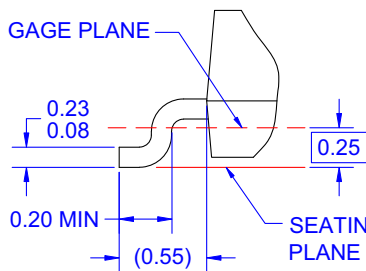
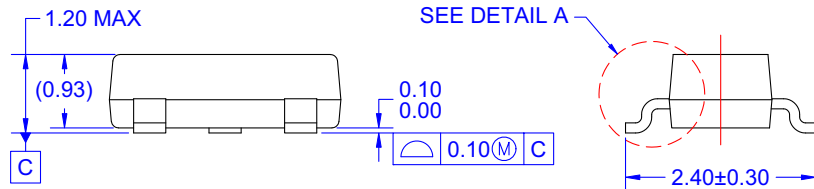
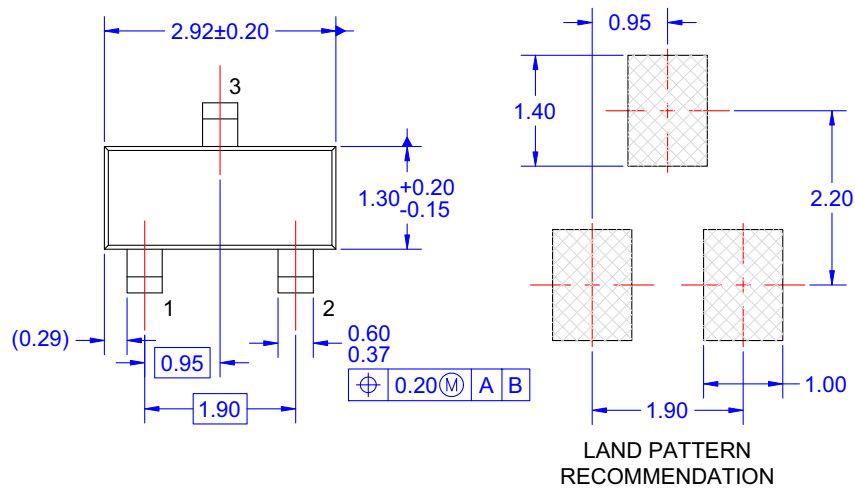

NOTES: UNLESS OTHERWISE SPECIFIED

- A) REFERENCE JEDEC REGISTRATION TO-236, VARIATION AB, ISSUE H.
- B) ALL DIMENSIONS ARE IN MILLIMETERS.
- C) DIMENSIONS ARE INCLUSIVE OF BURRS, MOLD FLASH AND TIE BAR EXTRUSIONS.
- D) DIMENSIONING AND TOLERANCING PER ASME Y14.5M - 1994.
- E) DRAWING FILE NAME: MA03DREV10

**DETAIL A**  
SCALE: 2X

**Figure 16. 3-LEAD, SOT23, JEDEC TO-236, LOW PROFILE (ACTIVE)**

Package drawings are provided as a service to customers considering ON Semiconductor components. Drawings may change in any manner without notice. Please note the revision and/or date on the drawing and contact a ON Semiconductor representative to verify or obtain the most recent revision. Package specifications do not expand the terms of ON Semiconductor's worldwide terms and conditions, specifically the warranty therein, which covers ON Semiconductor products.

Physical Dimensions (Continued)

SOT-223

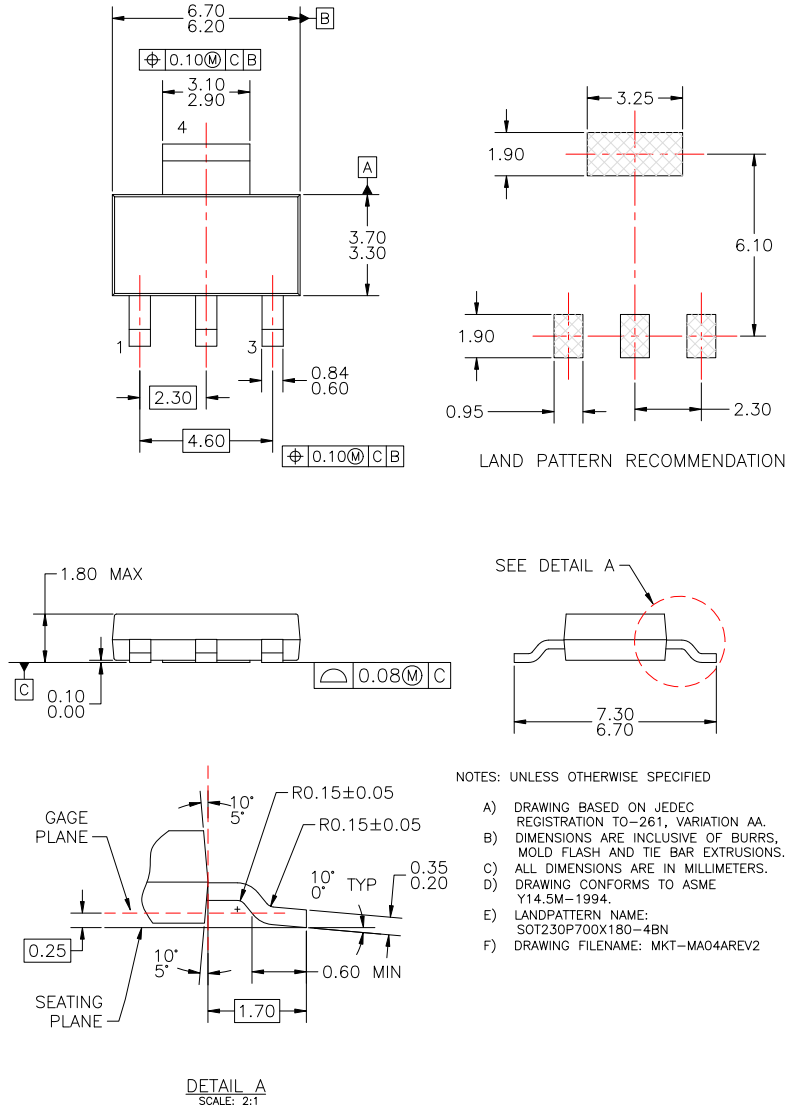



Figure 17. MOLDED PACKAGING, SOT-223, 4-LEAD (ACTIVE)

Package drawings are provided as a service to customers considering ON Semiconductor components. Drawings may change in any manner without notice. Please note the revision and/or date on the drawing and contact a ON Semiconductor representative to verify or obtain the most recent revision. Package specifications do not expand the terms of ON Semiconductor's worldwide terms and conditions, specifically the warranty therein, which covers ON Semiconductor products.

ON Semiconductor and  are trademarks of Semiconductor Components Industries, LLC dba ON Semiconductor or its subsidiaries in the United States and/or other countries. ON Semiconductor owns the rights to a number of patents, trademarks, copyrights, trade secrets, and other intellectual property. A listing of ON Semiconductor's product/patent coverage may be accessed at [www.onsemi.com/site/pdf/Patent-Marking.pdf](http://www.onsemi.com/site/pdf/Patent-Marking.pdf). ON Semiconductor reserves the right to make changes without further notice to any products herein. ON Semiconductor makes no warranty, representation or guarantee regarding the suitability of its products for any particular purpose, nor does ON Semiconductor assume any liability arising out of the application or use of any product or circuit, and specifically disclaims any and all liability, including without limitation special, consequential or incidental damages. Buyer is responsible for its products and applications using ON Semiconductor products, including compliance with all laws, regulations and safety requirements or standards, regardless of any support or applications information provided by ON Semiconductor. "Typical" parameters which may be provided in ON Semiconductor data sheets and/or specifications can and do vary in different applications and actual performance may vary over time. All operating parameters, including "Typicals" must be validated for each customer application by customer's technical experts. ON Semiconductor does not convey any license under its patent rights nor the rights of others. ON Semiconductor products are not designed, intended, or authorized for use as a critical component in life support systems or any FDA Class 3 medical devices or medical devices with a same or similar classification in a foreign jurisdiction or any devices intended for implantation in the human body. Should Buyer purchase or use ON Semiconductor products for any such unintended or unauthorized application, Buyer shall indemnify and hold ON Semiconductor and its officers, employees, subsidiaries, affiliates, and distributors harmless against all claims, costs, damages, and expenses, and reasonable attorney fees arising out of, directly or indirectly, any claim of personal injury or death associated with such unintended or unauthorized use, even if such claim alleges that ON Semiconductor was negligent regarding the design or manufacture of the part. ON Semiconductor is an Equal Opportunity/Affirmative Action Employer. This literature is subject to all applicable copyright laws and is not for resale in any manner.

## PUBLICATION ORDERING INFORMATION

### LITERATURE FULFILLMENT:

Literature Distribution Center for ON Semiconductor  
19521 E. 32nd Pkwy, Aurora, Colorado 80011 USA  
**Phone:** 303-675-2175 or 800-344-3860 Toll Free USA/Canada  
**Fax:** 303-675-2176 or 800-344-3867 Toll Free USA/Canada  
**Email:** [orderlit@onsemi.com](mailto:orderlit@onsemi.com)

**N. American Technical Support:** 800-282-9855 Toll Free  
USA/Canada  
**Europe, Middle East and Africa Technical Support:**  
Phone: 421 33 790 2910  
**Japan Customer Focus Center**  
Phone: 81-3-5817-1050

**ON Semiconductor Website:** [www.onsemi.com](http://www.onsemi.com)

**Order Literature:** <http://www.onsemi.com/orderlit>

For additional information, please contact your local Sales Representative



## OUR CERTIFICATE

DiGi provide top-quality products and perfect service for customer worldwide through standardization, technological innovation and continuous improvement. DiGi through third-party certification, we strictly control the quality of products and services. Welcome your RFQ to

Email: [Info@DiGi-Electronics.com](mailto:Info@DiGi-Electronics.com)



Tel: +00 852-30501935

RFQ Email: [Info@DiGi-Electronics.com](mailto:Info@DiGi-Electronics.com)

DiGi is a global authorized distributor of electronic components.