

GL537 Datasheet



DiGi Electronics Part Number	GL537-DG
Manufacturer	Sharp Microelectronics
Manufacturer Product Number	GL537
Description	EMITTER IR 950NM 100MA T 1 3/4
Detailed Description	Infrared (IR) Emitter 950nm 1.3V 100mA 6mW/sr @ 50mA 50° T 1 3/4

<https://www.DiGi-Electronics.com>

This model GL537 is available at DiGi Electronics.

DiGi Electronics offers a global database of semiconductor and electronic component datasheets.

We welcome your inquiries regarding pricing, lead time, or other product-related questions.

 [Request a Quote](#)

 [Datasheet Search](#)



Tel: +00 852-30501935

RFQ Email: Info@DiGi-Electronics.com

DiGi is a global authorized distributor of electronic components.

Purchase and inquiry

Manufacturer Product Number:

GL537

Series:

-

Manufacturer:

Sharp Microelectronics

GL537/GL538

φ 5mm Resin Mold Type Infrared Emitting Diode

■ Features

- High output power
I_E: TYP. 30mW/sr at I_F = 50mA (**GL538**)
- Beam angle
GL538 Δθ : TYP. ± 13°
GL537 Δθ : TYP. ± 25°
- φ 5mm epoxy resin package

■ Applications

- Infrared remote controllers for TVs, VCRs, audio equipment and air conditioners

■ Absolute Maximum Ratings (Ta = 25°C)

Parameter	Symbol	Rating	Unit
Power dissipation	P	150	mW
Forward current	I _F	100	mA
*1 Peak forward current	I _{FM}	1	A
Reverse voltage	V _R	6	V
Operating temperature	T _{opr}	- 25 to + 85	°C
Storage temperature	T _{stg}	- 40 to + 85	°C
*2 Soldering temperature	T _{sol}	260	°C

*1 Pulse width ≤ 100 μs, Duty ratio = 0.01

*2 For 3 seconds at the position of 2.6mm from the bottom face of resin package.

■ Electro-optical Characteristics (Ta = 25°C)

Parameter	Symbol	Conditions	MIN.	TYP.	MAX.	Unit
Forward voltage	V _F	I _F = 50mA	-	1.3	1.5	V
Peak forward voltage	V _{FM}	I _{FM} = 0.5A	-	1.9	3.0	V
Reverse current	I _R	V _R = 3V	-	-	10	μA
Peak emission wavelength	λ _P	I _F = 5mA	-	950	-	nm
Half intensity wavelength	Δλ	I _F = 5mA	-	45	-	nm
*3 Radiation intensity	GL537	I _E = 50mA	6	13	-	mW/sr
	GL538		15	30	-	
Terminal capacitance	C _t	V _R = 0, f = 1kHz	-	50	-	pF
Response frequency	f _c	-	-	300	-	kHz
Half intensity angle	GL537	I _F = 20mA	-	± 25	-	°
	GL538		-	± 13	-	

*3 I_E: Value obtained by converting the value in power of radiant fluxes emitted at the solid angle of 0.01 sr (steradian) in the direction of mechanical axis of the lens portion into 1 sr of all those emitted from the light emitting diode.

■ Outline Dimensions (Unit : mm)

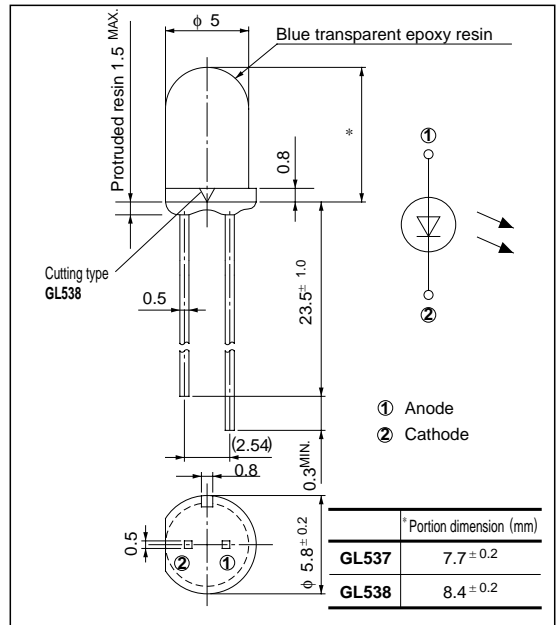

Fig. 1 Forward Current vs. Ambient Temperature

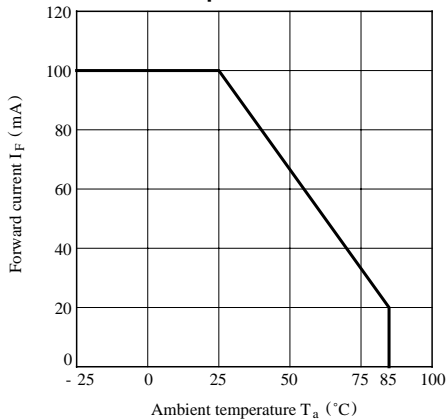

Fig. 2 Peak Forward Current vs. Duty Ratio

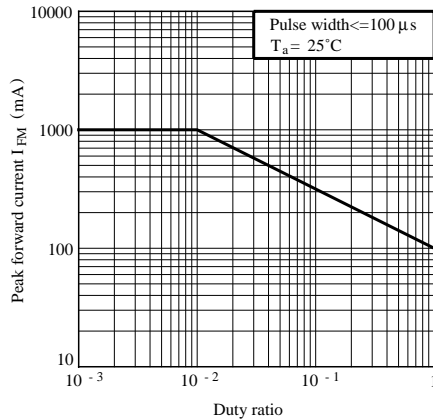

Fig. 3 Spectral Distribution

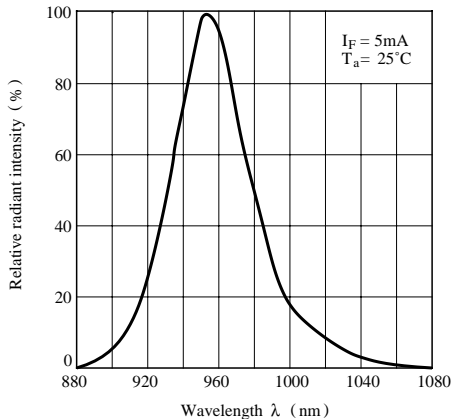

Fig. 4 Peak Emission Wave length vs. Ambient Temperature

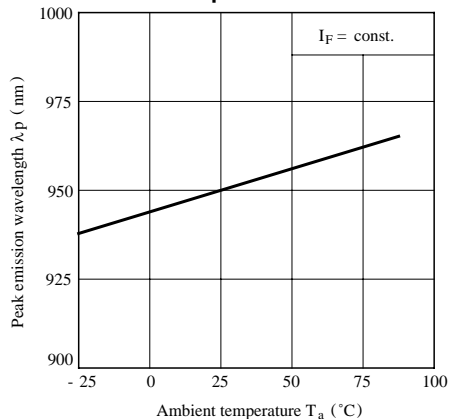

Fig. 5 Forward Current vs. Forward Voltage

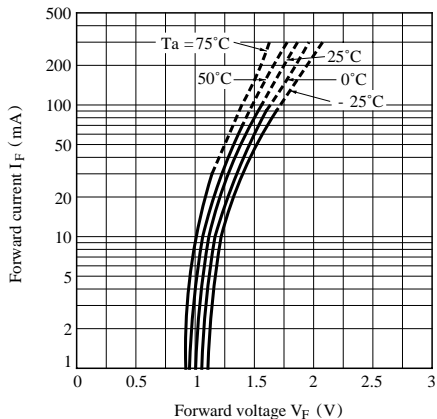

Fig. 6 Relative Forward Voltage vs. Ambient Temperature

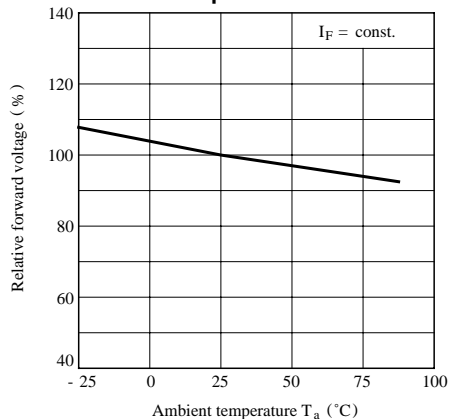

Fig. 7 Relative Output vs. Ambient Temperature (Detector : PD410PI)

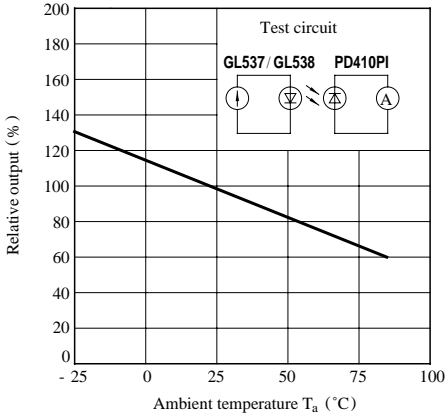

Fig. 8 Radiation Intensity vs. Peak Forward Current

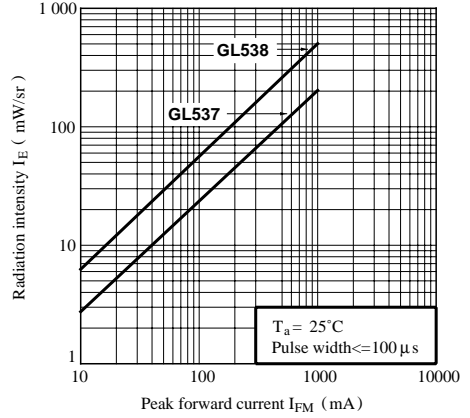

Fig. 9 Relative Collector Current vs. Distance (Detector : PD410PI)

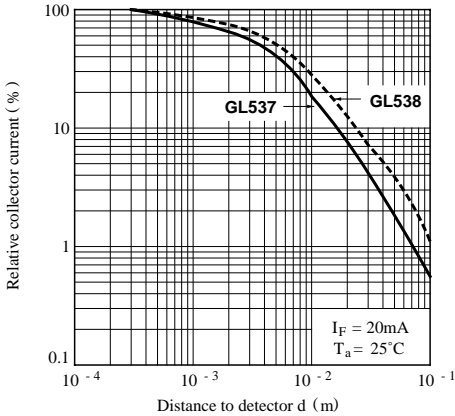

Fig.10 Relative Collector Current vs. Distance (Detector : PD49PI)

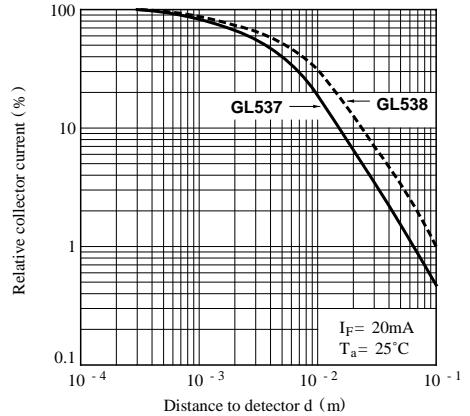

Fig.11-a Radiation Diagram (GL537) (Ta = 25°C)

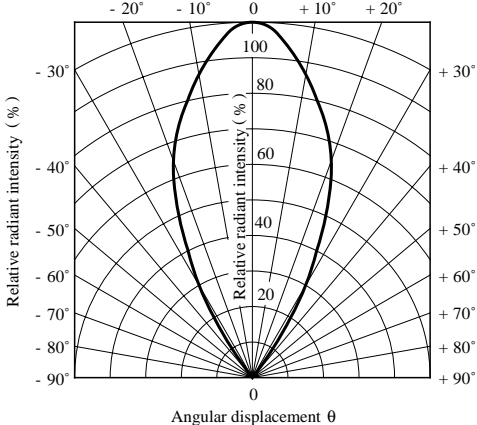
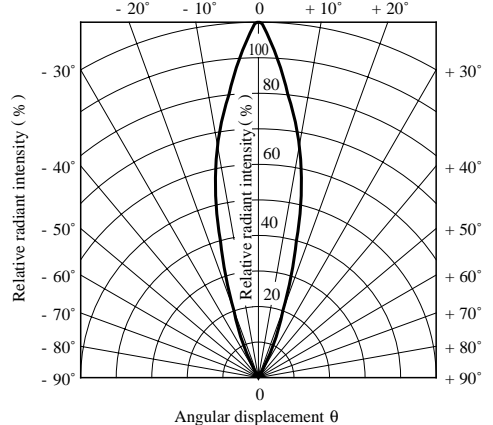

Fig.11-b Radiation Diagram (GL538) (Ta = 25°C)



NOTICE

- The circuit application examples in this publication are provided to explain representative applications of SHARP devices and are not intended to guarantee any circuit design or license any intellectual property rights. SHARP takes no responsibility for any problems related to any intellectual property right of a third party resulting from the use of SHARP's devices.
- Contact SHARP in order to obtain the latest device specification sheets before using any SHARP device. SHARP reserves the right to make changes in the specifications, characteristics, data, materials, structure, and other contents described herein at any time without notice in order to improve design or reliability. Manufacturing locations are also subject to change without notice.
- Observe the following points when using any devices in this publication. SHARP takes no responsibility for damage caused by improper use of the devices which does not meet the conditions and absolute maximum ratings to be used specified in the relevant specification sheet nor meet the following conditions:
 - (i) The devices in this publication are designed for use in general electronic equipment designs such as:
 - Personal computers
 - Office automation equipment
 - Telecommunication equipment [terminal]
 - Test and measurement equipment
 - Industrial control
 - Audio visual equipment
 - Consumer electronics
 - (ii) Measures such as fail-safe function and redundant design should be taken to ensure reliability and safety when SHARP devices are used for or in connection with equipment that requires higher reliability such as:
 - Transportation control and safety equipment (i.e., aircraft, trains, automobiles, etc.)
 - Traffic signals
 - Gas leakage sensor breakers
 - Alarm equipment
 - Various safety devices, etc.
 - (iii) SHARP devices shall not be used for or in connection with equipment that requires an extremely high level of reliability and safety such as:
 - Space applications
 - Telecommunication equipment [trunk lines]
 - Nuclear power control equipment
 - Medical and other life support equipment (e.g., scuba).
- Contact a SHARP representative in advance when intending to use SHARP devices for any "specific" applications other than those recommended by SHARP or when it is unclear which category mentioned above controls the intended use.
- If the SHARP devices listed in this publication fall within the scope of strategic products described in the Foreign Exchange and Foreign Trade Control Law of Japan, it is necessary to obtain approval to export such SHARP devices.
- This publication is the proprietary product of SHARP and is copyrighted, with all rights reserved. Under the copyright laws, no part of this publication may be reproduced or transmitted in any form or by any means, electronic or mechanical, for any purpose, in whole or in part, without the express written permission of SHARP. Express written permission is also required before any use of this publication may be made by a third party.
- Contact and consult with a SHARP representative if there are any questions about the contents of this publication.

