

GP1S093HCZ Datasheet

www.digi-electronics.com

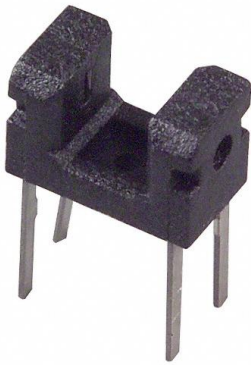

<https://www.DiGi-Electronics.com>

DiGi Electronics Part Number	GP1S093HCZ-DG
Manufacturer	Sharp Microelectronics
Manufacturer Product Number	GP1S093HCZ
Description	SENSOR OPT SLOT PHOTOTRAN PCB MT
Detailed Description	Optical Sensor Through-Beam 0.079" (2mm) Photo transistor PCB Mount

This model GP1S093HCZ is available at DiGi Electronics.

DiGi Electronics offers a global database of semiconductor and electronic component datasheets.

We welcome your inquiries regarding pricing, lead time, or other product-related questions.

 [Request a Quote](#)

 [Datasheet Search](#)



Tel: +00 852-30501935

RFQ Email: Info@DiGi-Electronics.com

DiGi is a global authorized distributor of electronic components.

Purchase and inquiry

Manufacturer Product Number:

GP1S093HCZ

Series:

-

Sensing Distance:

0.079" (2mm)

Output Configuration:

Phototransistor

Current - Collector (Ic) (Max):

20 mA

Response Time:

50µs, 50µs

Mounting Type:

Through Hole

Type:

Unamplified

Manufacturer:

Sharp Microelectronics

Product Status:

Obsolete

Sensing Method:

Through-Beam

Current - DC Forward (If) (Max):

50 mA

Voltage - Collector Emitter Breakdown (Max):

35 V

Operating Temperature:

-25°C ~ 85°C

Package / Case:

PCB Mount

Environmental & Export classification

RoHS Status:

RoHS non-compliant

ECCN:

EAR99

Moisture Sensitivity Level (MSL):

1 (Unlimited)

HTSUS:

8541.49.8000

GP1S093HCZ

Subminiature, Low Profile, Transmissive Type Photointerrupter

■ Features

1. General purpose
2. Low profile(Height:2.9mm)
3. Wide gap(Gap width:2.0mm)
4. Slit width(Detector side):0.3mm

■ Applications

1. Cameras
2. CD-ROM drives
3. VCR

■ Absolute Maximum Ratings (Ta=25°C)

	Parameter	Symbol	Rating	Unit
Input	Forward current	I_F	50	mA
	Reverse voltage	V_R	6	V
	Power dissipation	P	75	mW
Output	Collector-emitter voltage	V_{CEO}	35	V
	Emitter-collector voltage	V_{ECO}	6	V
	Collector current	I_C	20	mA
	Collector power dissipation	P_C	75	mW
	Total power dissipation	P_{tot}	100	mW
	Operating temperature	T_{opr}	-25 to +85	°C
	Storage temperature	T_{stg}	-40 to +100	°C
	*1 Soldering temperature	T_{sol}	260	°C

*1 For MAX. 5s

■ Outline Dimensions

(Unit : mm)

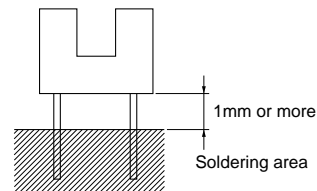
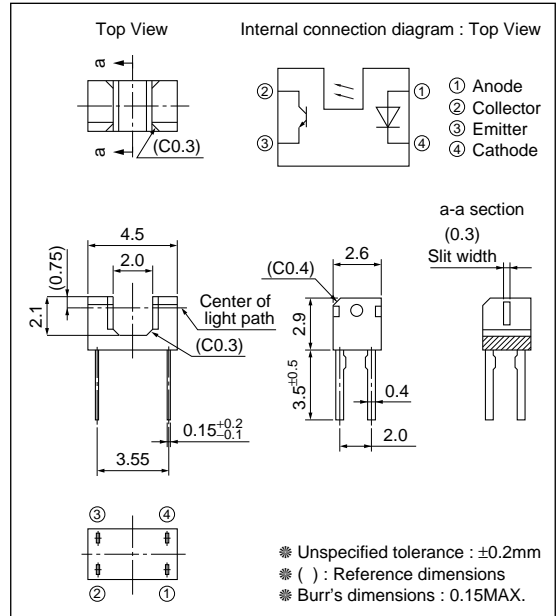

■ Electro-optical Characteristics

($T_a=25^\circ\text{C}$)

Parameter		Symbol	Conditions	MIN.	TYP.	MAX.	Unit
Input	Forward voltage	V_F	$I_F=20\text{mA}$	-	1.2	1.4	V
	Reverse current	I_R	$V_R=3\text{V}$	-	-	10	μA
Output	Collector dark current	I_{CE0}	$V_{CE}=20\text{V}$	-	-	100	nA
Transfer characteristics	Collector current	I_C	$V_{CE}=5\text{V}, I_F=5\text{mA}$	100	-	400	μA
	Collector-emitter saturation voltage	$V_{CE(sat)}$	$I_F=10\text{mA}, I_C=40\mu\text{A}$	-	-	0.4	V
	Response time	Rise time	t_r	$V_{CE}=5\text{V}, I_C=100\mu\text{A}$ $R_L=1\ 000\Omega$	-	50	150
Fall time		t_f	-		50	150	μs

Fig.1 Forward Current vs. Ambient Temperature

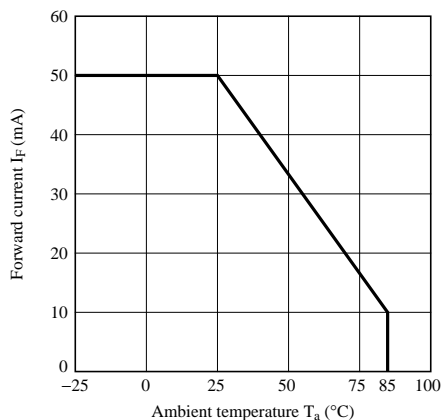

Fig.2 Power Dissipation vs. Ambient Temperature

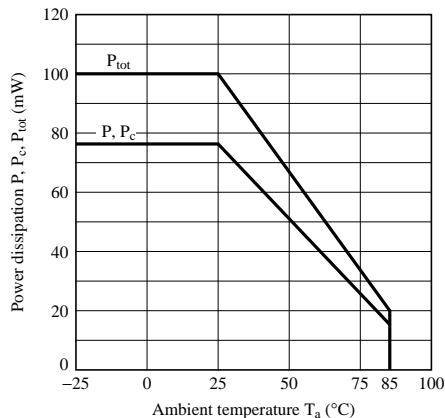

Fig.3 Forward Current vs. Forward Voltage

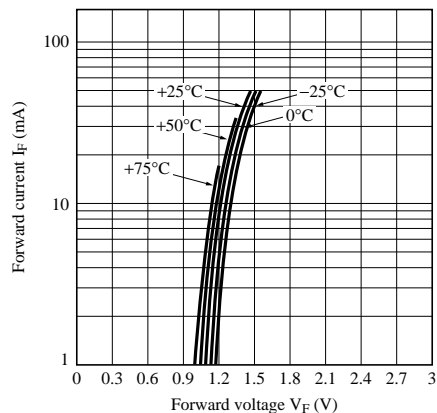

Fig.4 Collector Current vs. Forward Current

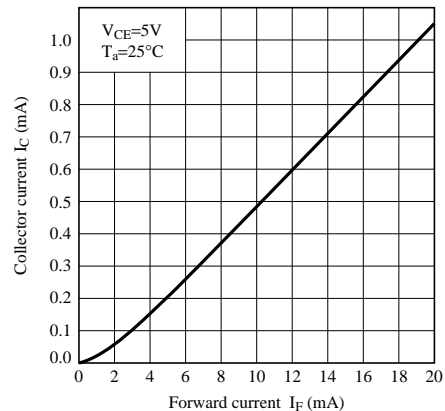

Fig.5 Collector Current vs. Collector-emitter Voltage

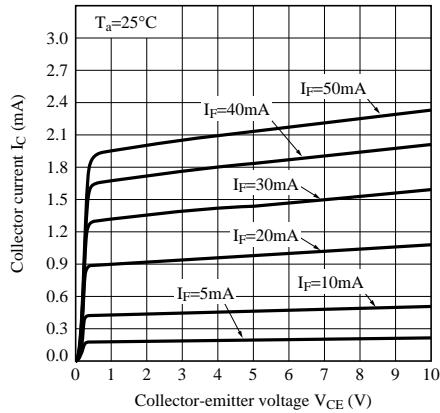

Fig.6 Relative Collector Current vs. Ambient Temperature

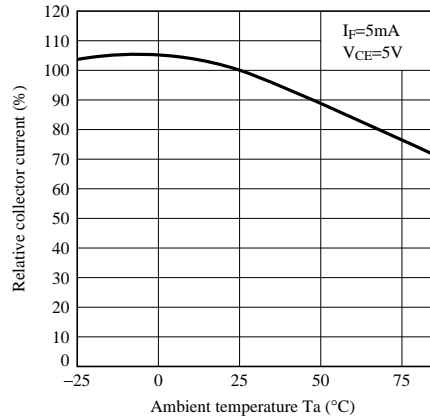

Fig.7 Collector - emitter Saturation Voltage vs. Ambient Temperature

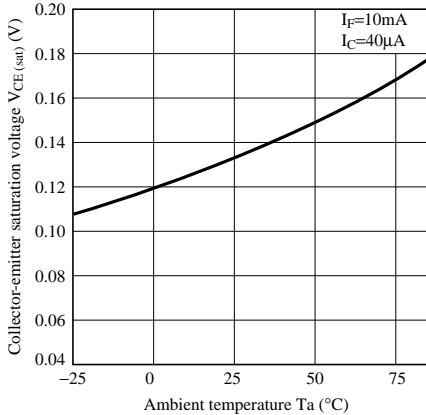

Fig.8 Collector Dark Current vs. Ambient Temperature

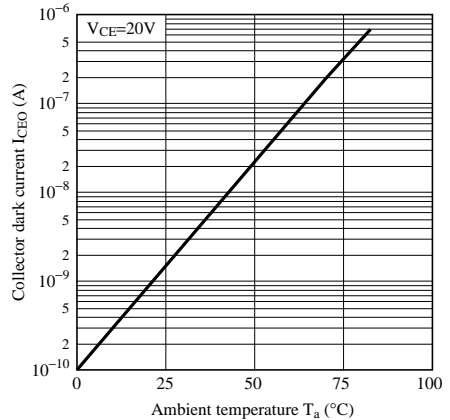

Fig.9 Response Time vs. Load Resistance

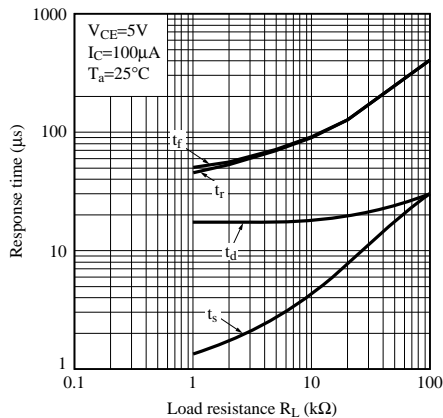

Fig.10 Test Circuit for Response Time

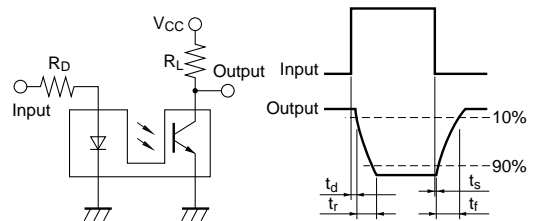

Fig.11 Relative Collector Current vs. Shield Distance (1)

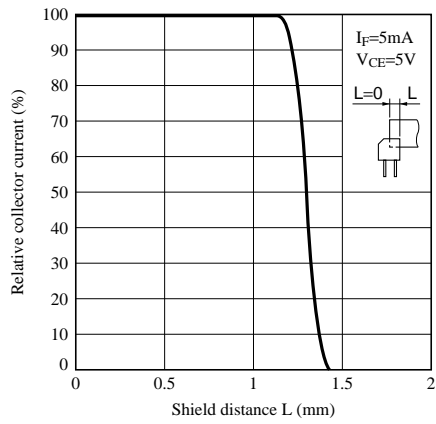
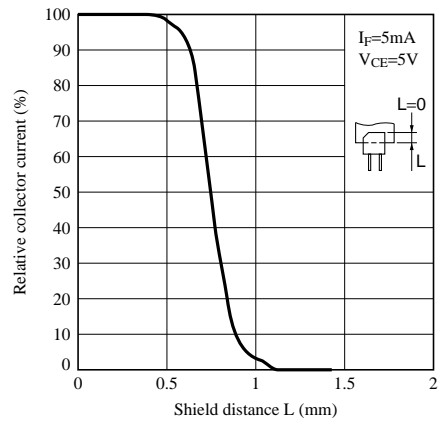

Fig.12 Relative Collector Current vs. Shield Distance (2)



NOTICE

- The circuit application examples in this publication are provided to explain representative applications of SHARP devices and are not intended to guarantee any circuit design or license any intellectual property rights. SHARP takes no responsibility for any problems related to any intellectual property right of a third party resulting from the use of SHARP's devices.
- Contact SHARP in order to obtain the latest device specification sheets before using any SHARP device. SHARP reserves the right to make changes in the specifications, characteristics, data, materials, structure, and other contents described herein at any time without notice in order to improve design or reliability. Manufacturing locations are also subject to change without notice.
- Observe the following points when using any devices in this publication. SHARP takes no responsibility for damage caused by improper use of the devices which does not meet the conditions and absolute maximum ratings to be used specified in the relevant specification sheet nor meet the following conditions:
 - (i) The devices in this publication are designed for use in general electronic equipment designs such as:
 - Personal computers
 - Office automation equipment
 - Telecommunication equipment [terminal]
 - Test and measurement equipment
 - Industrial control
 - Audio visual equipment
 - Consumer electronics
 - (ii) Measures such as fail-safe function and redundant design should be taken to ensure reliability and safety when SHARP devices are used for or in connection with equipment that requires higher reliability such as:
 - Transportation control and safety equipment (i.e., aircraft, trains, automobiles, etc.)
 - Traffic signals
 - Gas leakage sensor breakers
 - Alarm equipment
 - Various safety devices, etc.
 - (iii) SHARP devices shall not be used for or in connection with equipment that requires an extremely high level of reliability and safety such as:
 - Space applications
 - Telecommunication equipment [trunk lines]
 - Nuclear power control equipment
 - Medical and other life support equipment (e.g., scuba).
- Contact a SHARP representative in advance when intending to use SHARP devices for any "specific" applications other than those recommended by SHARP or when it is unclear which category mentioned above controls the intended use.
- If the SHARP devices listed in this publication fall within the scope of strategic products described in the Foreign Exchange and Foreign Trade Control Law of Japan, it is necessary to obtain approval to export such SHARP devices.
- This publication is the proprietary product of SHARP and is copyrighted, with all rights reserved. Under the copyright laws, no part of this publication may be reproduced or transmitted in any form or by any means, electronic or mechanical, for any purpose, in whole or in part, without the express written permission of SHARP. Express written permission is also required before any use of this publication may be made by a third party.
- Contact and consult with a SHARP representative if there are any questions about the contents of this publication.

OUR CERTIFICATE

DiGi provide top-quality products and perfect service for customer worldwide through standardization, technological innovation and continuous improvement. DiGi through third-party certification, we stricly control the quality of products and services. Welcome your RFQ to

Email: Info@DiGi-Electronics.com



Tel: +00 852-30501935

RFQ Email: Info@DiGi-Electronics.com

DiGi is a global authorized distributor of electronic components.