

PC4D10SNIP0F Datasheet

www.digi-electronics.com

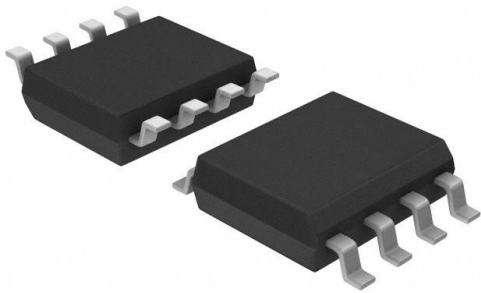

<https://www.DiGi-Electronics.com>

DiGi Electronics Part Number	PC4D10SNIP0F-DG
Manufacturer	Sharp Microelectronics
Manufacturer Product Number	PC4D10SNIP0F
Description	OPTOISO 3.75KV OPEN COLL 8MFLAT
Detailed Description	Logic Output Optoisolator 10Mbps Open Collector 3 750Vrms 2 Channel 10kV/μs CMTI 8-Miniflat

This model PC4D10SNIP0F is available at DiGi Electronics.

DiGi Electronics offers a global database of semiconductor and electronic component datasheets.

We welcome your inquiries regarding pricing, lead time, or other product-related questions.

 [Request a Quote](#)

 [Datasheet Search](#)



Tel: +00 852-30501935

RFQ Email: Info@DiGi-Electronics.com

DiGi is a global authorized distributor of electronic components.

Purchase and inquiry

Manufacturer Product Number:

PC4D10SNIP0F

Series:

OPIC™

Number of Channels:

2

Voltage - Isolation:

3750Vrms

Input Type:

DC

Current - Output / Channel:

50 mA

Propagation Delay tpLH / tpHL (Max):

75ns, 75ns

Voltage - Forward (Vf) (Typ):

1.5V

Voltage - Supply:

4.5V ~ 5.5V

Mounting Type:

Surface Mount

Supplier Device Package:

8-Miniflat

Manufacturer:

Sharp Microelectronics

Product Status:

Obsolete

Inputs - Side 1/Side 2:

2/0

Common Mode Transient Immunity (Min):

10kV/μs

Output Type:

Open Collector

Data Rate:

10Mbps

Rise / Fall Time (Typ):

20ns, 10ns

Current - DC Forward (If) (Max):

20mA

Operating Temperature:

-40°C ~ 85°C

Package / Case:

8-SOIC (0.154", 3.90mm Width)

Environmental & Export classification

Moisture Sensitivity Level (MSL):

1 (Unlimited)

HTSUS:

8541.49.8000

ECCN:

EAR99

PC4D10SNIP0F Series

High Speed 10Mb/s, High CMR
Mini-flat 2-channel Package
*OPIC Photocoupler

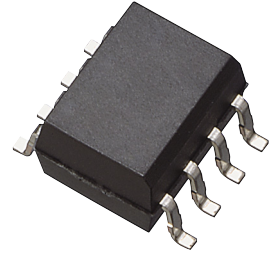

■ Description

PC4D10SNIP0F Series contains a LED optically coupled to an OPIC.

It is packaged in a 8 pin mini-flat (2-ch output).

Input-output isolation voltage(rms) is 3.75 kV.

High speed response (TYP. 10Mb/s) and CMR is MIN. 10kV/μs.

■ Features

1. 2-ch output, 8 pin Mini-flat package
2. Double transfer mold package
(Ideal for Flow Soldering)
3. High noise immunity due to high instantaneous common mode rejection voltage (CM_H : MIN. 10kV/μs, CM_L : MIN. -10kV/μs)
4. High speed response
(t_{PHL} : TYP. 50ns, t_{PLH} : TYP. 48ns)
5. Isolation voltage between input and output ($V_{iso(rms)}$) : 3.75kV)
6. Lead-free and RoHS directive compliant

■ Agency approvals/Compliance

1. Recognized by UL1577 (Double protection isolation), file No. E64380 (as model No. **PC4D10S**)
2. Approved by VDE, DIN EN60747-5-2^(*) (as an option), file No. 40009162 (as model No. **PC4D10S**)
3. Package resin : UL flammability grade (94V-0))

^(*) DIN EN60747-5-2 : successor standard of DIN VDE0884.

■ Applications

1. Programmable controller
2. Inverter

* "OPIC"(Optical IC) is a trademark of the SHARP Corporation. An OPIC consists of a light-detecting element and a signal-processing circuit integrated onto a single chip.

Notice The content of data sheet is subject to change without prior notice.
In the absence of confirmation by device specification sheets, SHARP takes no responsibility for any defects that may occur in equipment using any SHARP devices shown in catalogs, data books, etc. Contact SHARP in order to obtain the latest device specification sheets before using any SHARP device.

Internal Connection Diagram

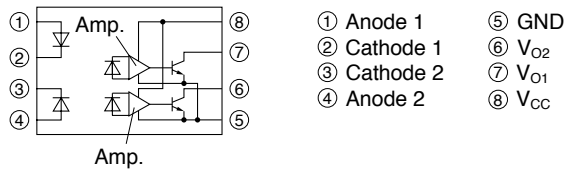

Truth table

Channel	Input	LED	Output
1	H	ON	L
	L	OFF	H
2	H	ON	L
	L	OFF	H

Outline Dimensions

(Unit : mm)

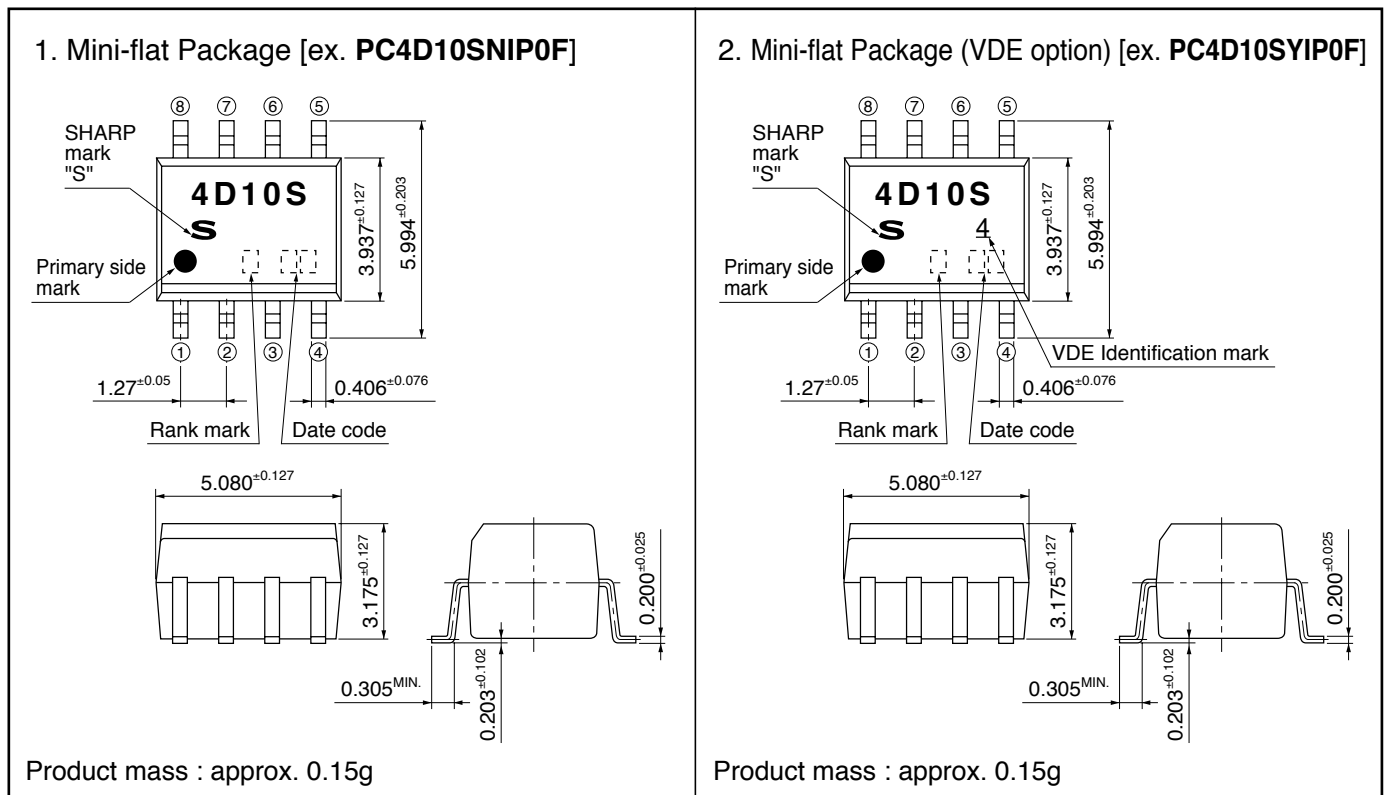

Plating material : Pd (Au flush)

Date code (2 digit)

1st digit				2nd digit	
Year of production				Month of production	
A.D.	Mark	A.D.	Mark	Month	Mark
1990	A	2002	P	January	1
1991	B	2003	R	February	2
1992	C	2004	S	March	3
1993	D	2005	T	April	4
1994	E	2006	U	May	5
1995	F	2007	V	June	6
1996	H	2008	W	July	7
1997	J	2009	X	August	8
1998	K	2010	A	September	9
1999	L	2011	B	October	O
2000	M	2012	C	November	N
2001	N	:	:	December	D

repeats in a 20 year cycle

Country of origin

Japan

Rank mark

With or without.

■ Absolute Maximum Ratings

 (T_a=25°C)

Parameter		Symbol	Rating	Unit
Input	*1 Forward current	I _F	20	mA
	Reverse voltage	V _R	5	V
	Power dissipation	P _I	40	mW
Output	Supply voltage	V _{CC}	7	V
	Output collector voltage	V _O	7	V
	Output collector current	I _O	50	mA
	*1 Output collector power dissipation	P _C	60	mW
Operating temperature		T _{opr}	-40 to +85	°C
Storage temperature		T _{stg}	-55 to +125	°C
*2 Isolation voltage		V _{iso(rms)}	3.75	kV
*3 Soldering temperature		T _{sol}	270	°C

*1 No delating required up to 85°C

*2 40 to 60%RH, AC for 1minute, f=60Hz

*3 For 10s

■ Electro-optical Characteristics

 (Unless otherwise specified T_a=-40 to 85°C)

Parameter		Symbol	Condition	MIN.	TYP.*4	MAX.	Unit		
Input	Forward voltage	V _F	T _a =25°C, I _F =10mA	1.4	1.5	1.75	V		
			I _F =10mA	1.3	-	1.8			
	Reverse current	I _R	T _a =25°C, V _R =5V	-	-	10	μA		
Terminal capacitance		C _t	T _a =25°C, V=0, f=1MHz	-	60	150	pF		
*5 Output	Low level output voltage	V _{OL}	I _{OL} =13mA, V _{CC} =5.5V, V _E =2V, I _F =5mA	-	0.4	0.6	V		
	High level output current	I _{OH}	V _{CC} =V _O =5.5V, I _F =250μA	-	0.02	100	μA		
	Low level supply current	I _{CCL}	V _{CC} =5.5V, I _F =10mA	-	13	21	mA		
	High level supply current	I _{CCH}	V _{CC} =5.5V, I _F =0	-	10	15	mA		
"High→Low" input threshold current		I _{FHL}	V _{CC} =5V, V _O =0.6V, R _L =350Ω	-	2.5	5	mA		
Isolation resistance		R _{ISO}	T _a =25°C, DC500V, 40 to 60%RH	5×10 ¹⁰	10 ¹¹	-	Ω		
Floating capacitance		C _f	T _a =25°C, V=0, f=1MHz	-	0.6	-	pF		
*5 Transfer characteristics	Response time	"High→Low" propagation delay time	t _{PHL}	V _{CC} =5V, I _F =7.5mA, R _L =350Ω, C _L =15pF	T _a =25°C	-	-	100	ns
						25	48	75	ns
		"Low→High" propagation delay time	t _{PLH}	T _a =25°C	-	-	100	ns	
					25	50	75	ns	
		*6 Distortion of pulse width	Δt _w	-	3.5	35	ns		
		Rise time	t _r	-	20	-	ns		
		Fall time	t _f	-	10	-	ns		
Propagation delay skew	t _{PSK}	-	-	40	ns				
Instantaneous common mode rejection voltage (High level output)		CM _H	I _F =0, V _{O(Min)} =2V,	T _a =25°C, V _{CC} =5V, V _{CM} =1kV _(P-P) , R _L =350Ω	10	20	-	kV/μs	
Instantaneous common mode rejection voltage (Low level output)		CM _L	I _F =7.5mA, V _{O(MAX)} =0.8V		-10	-20	-	kV/μs	

 *4 All typical values at V_{CC}=5V, T_a=25°C

 *5 It shall connect a by-pass capacitor of 0.01μF or more between V_{CC} (pin ⑧) and GND (pin ⑤) near the device, when it measures the transfer characteristics and the output side characteristics

 *6 Distortion of pulse width Δt_w=|t_{PHL}-t_{PLH}|

Fig.1 Test Circuit for Propagation Delay Time and Rise Time, Fall Time

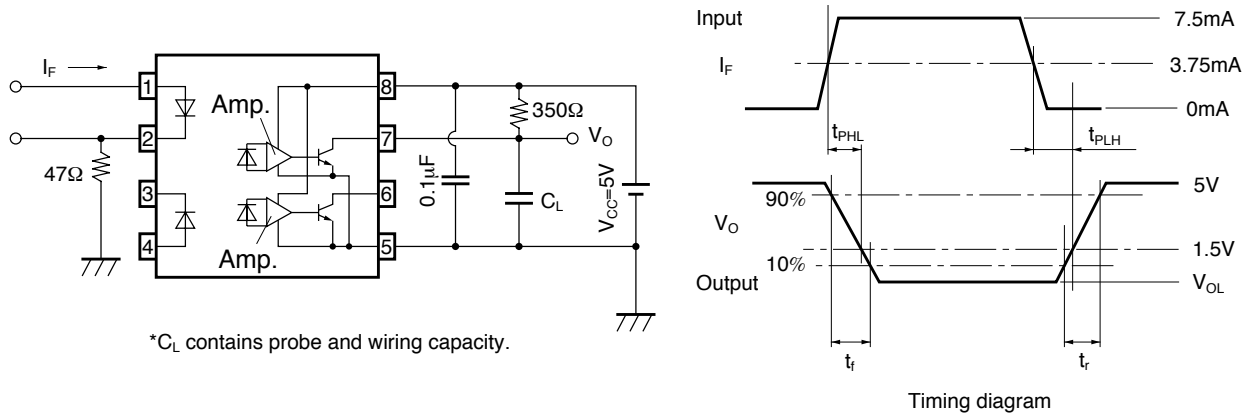

Fig.2 Test Circuit for Instantaneous Common Mode Rejection Voltage

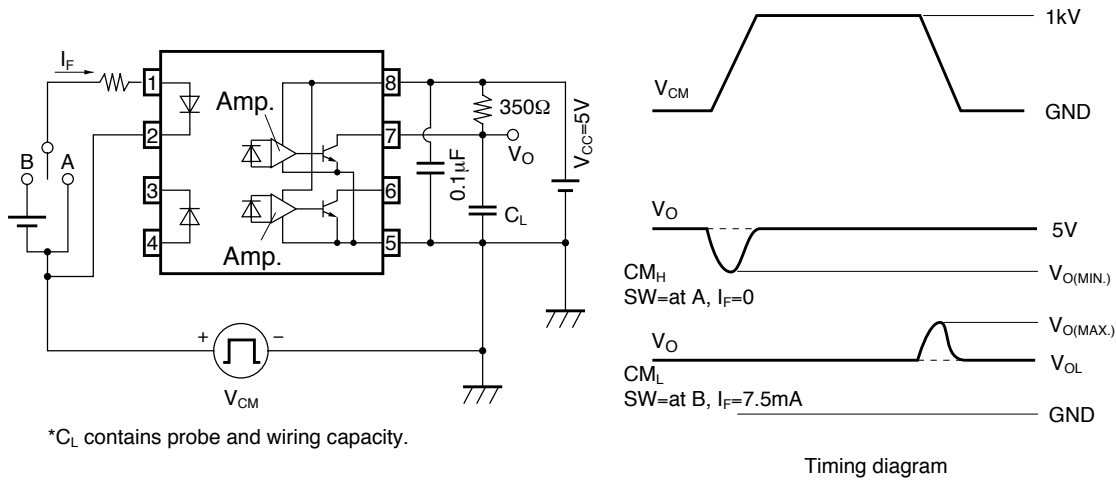

Fig.3 Forward Current vs. Ambient Temperature

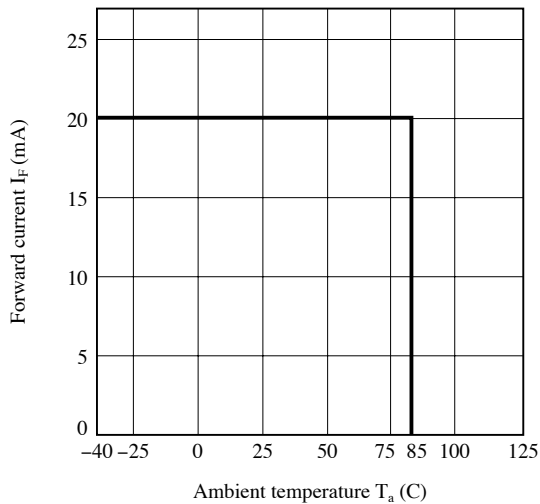

Fig.4 Output Collector Power Dissipation vs. Ambient Temperature

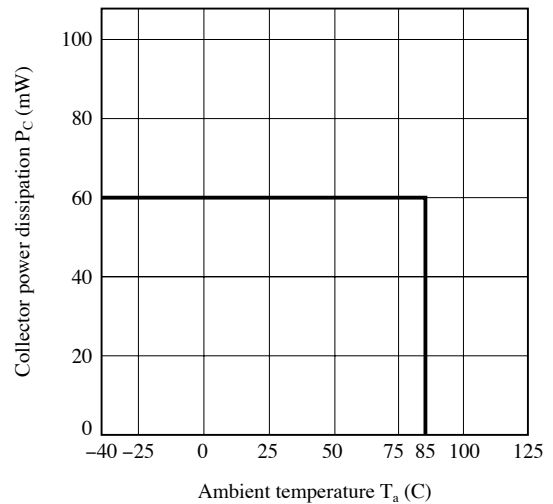

Fig.5 Forward Current vs. Forward Voltage

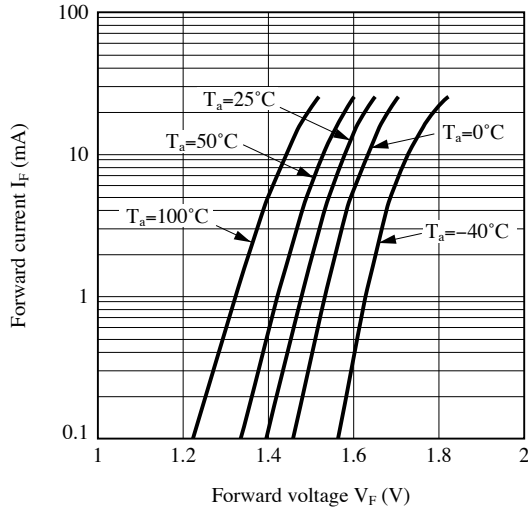

Fig.6 High Level Output Current vs. Ambient Temperature

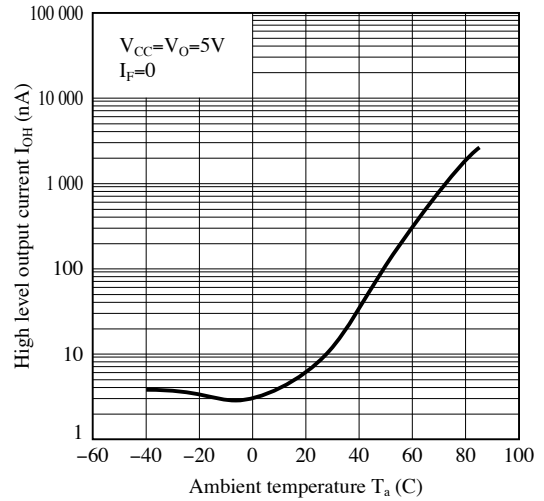

Fig.7 Low Level Output Voltage vs. Ambient Temperature

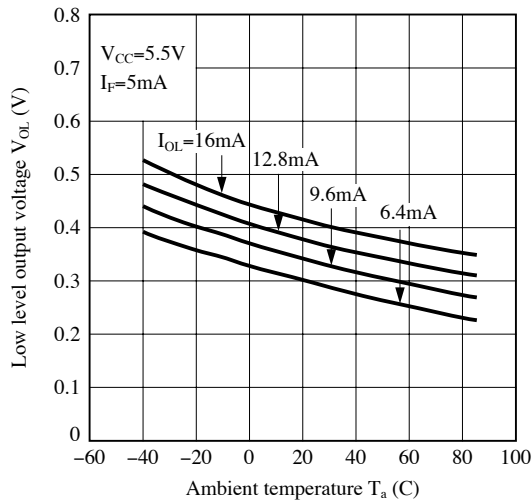

Fig.8 Output Voltage vs. Forward Current

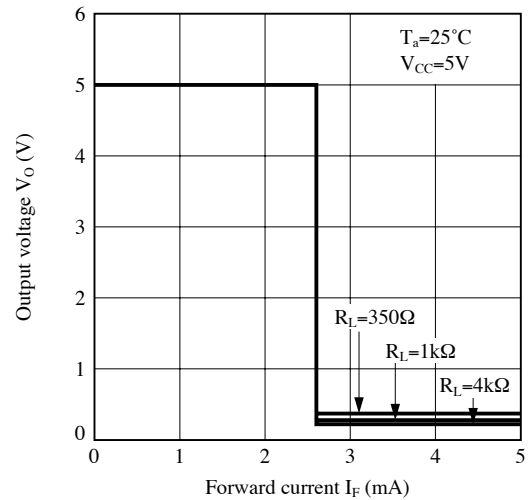

Fig.9 Input Threshold Current vs. Ambient Temperature

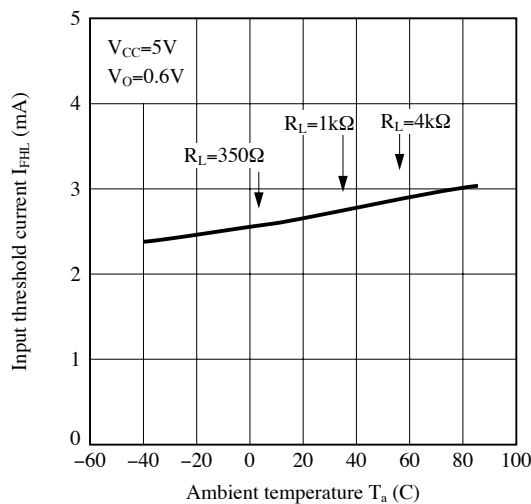

Fig.10 Propagation Delay Time vs. Forward Current

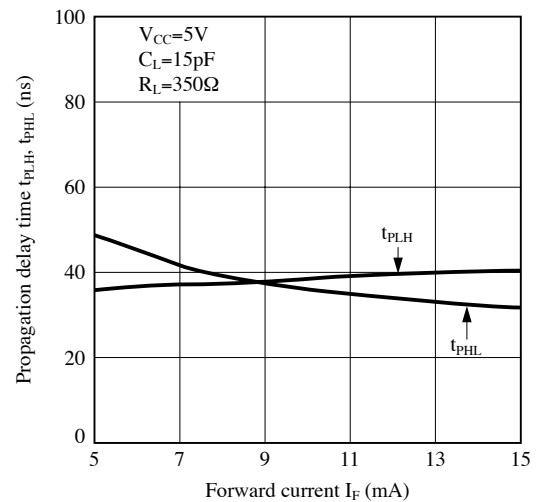

Fig.11-a Propagation Delay Time vs. Ambient Temperature

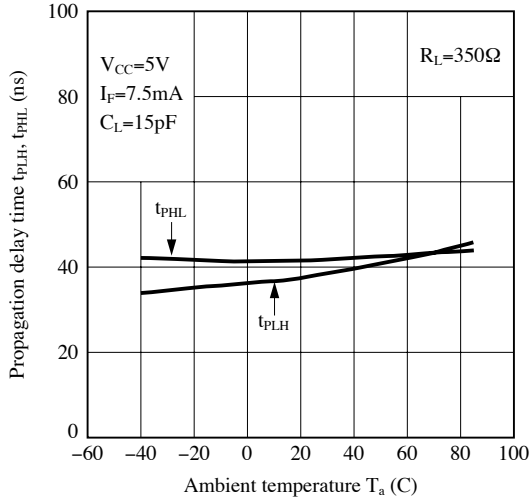

Fig.11-b Propagation Delay Time vs. Ambient Temperature

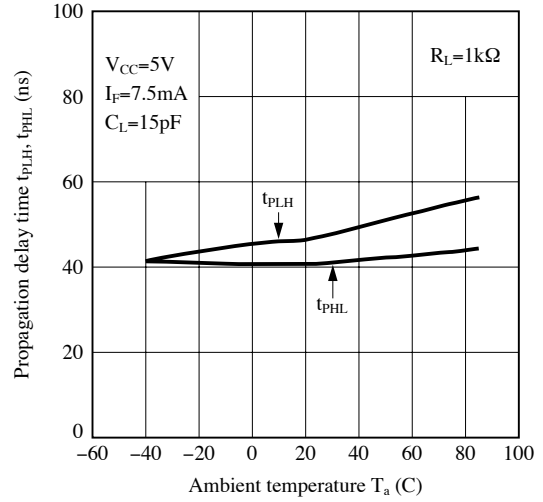

Fig.11-c Propagation Delay Time vs. Ambient Temperature

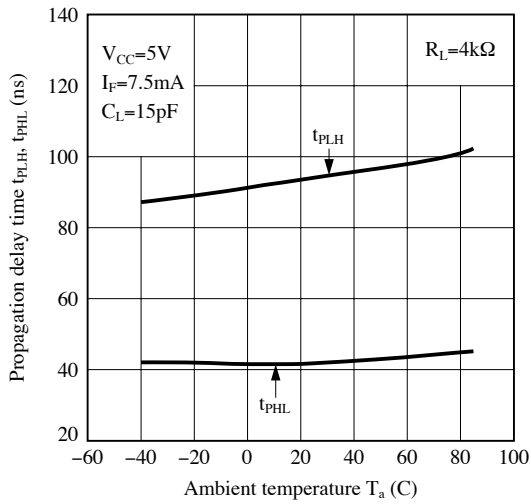

Fig.12 Pulse width Distortion vs. Ambient Temperature

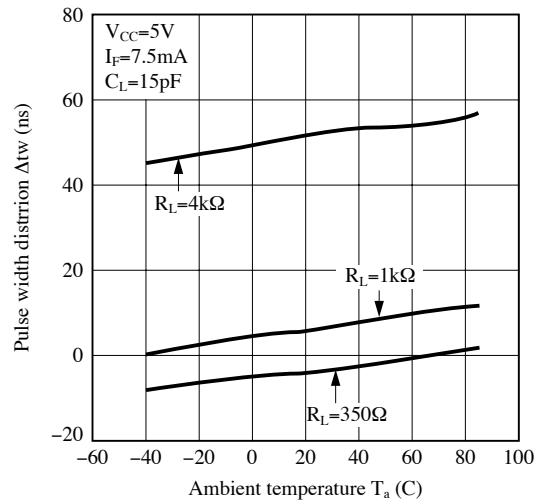
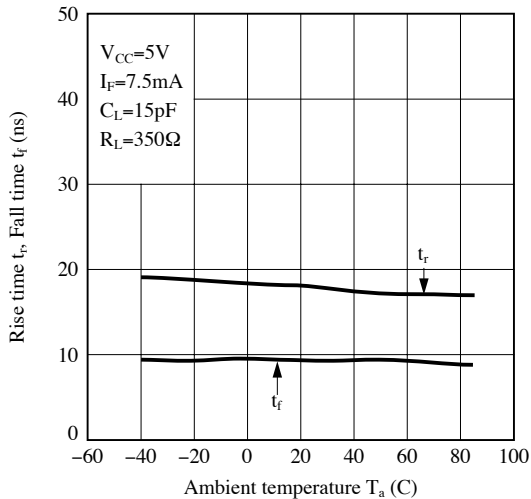

Fig.13 Rise Time / Fall Time vs. Ambient Temperature



Remarks : Please be aware that all data in the graph are just for reference and anot for guarantee.

■ Design Considerations

● Recommended operating conditions

Parameter	Symbol	MIN.	TYP.	MAX.	Unit
Low level input current	I_{FL}	0	–	250	μA
High level input current	I_{FH}	8	–	15	mA
Supply voltage	V_{CC}	4.5	–	5.5	V
Fan out (TTL load)	N	–	–	5	–
Output pull-up resistor	R_L	330	–	4 000	Ω
Operating temperature	T_{opr}	–40	–	+85	$^{\circ}C$

● Notes about static electricity

Transistor of detector side in bipolar configuration may be damaged by static electricity due to its minute design.

When handling these devices, general countermeasure against static electricity should be taken to avoid breakdown of devices or degradation of characteristics.

● Design guide

In order to stabilize power supply line, we should certainly recommend to connect a by-pass capacitor of 0.01 μF or more between V_{CC} and GND near the device.

In case that some sudden big noise caused by voltage variation is provided between primary and secondary terminals of photocoupler some current caused by it is floating capacitance may be generated and result in false operation since current may go through LED or current may change.

If the photocoupler may be used under the circumstances where noise will be generated we recommend to use the bypass capacitors at the both ends of LED.

The detector which is used in this device, has parasitic diode between each pins and GND.

There are cases that miss operation or destruction possibly may be occurred if electric potential of any pin becomes below GND level even for instant.

Therefore it shall be recommended to design the circuit that electric potential of any pin does not become below GND level.

This product is not designed against irradiation and incorporates non-coherent LED.

● Degradation

In general, the emission of the LED used in photocouplers will degrade over time.

In the case of long term operation, please take the general LED degradation (50% degradation over 5 years) into the design consideration.

Please decide the input current which become 2 times of MAX. I_{FHL} .

● Recommended foot print (reference)

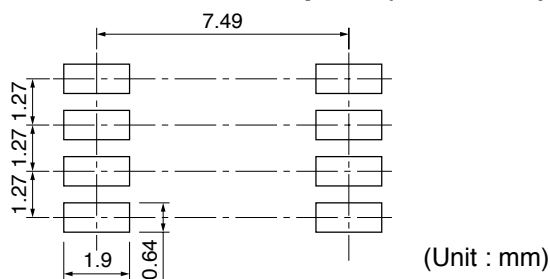

■ **Manufacturing Guidelines**

● **Soldering Method**

Reflow Soldering:

Reflow soldering should follow the temperature profile shown below.
 Soldering should not exceed the curve of temperature profile and time.
 Please don't solder more than twice.

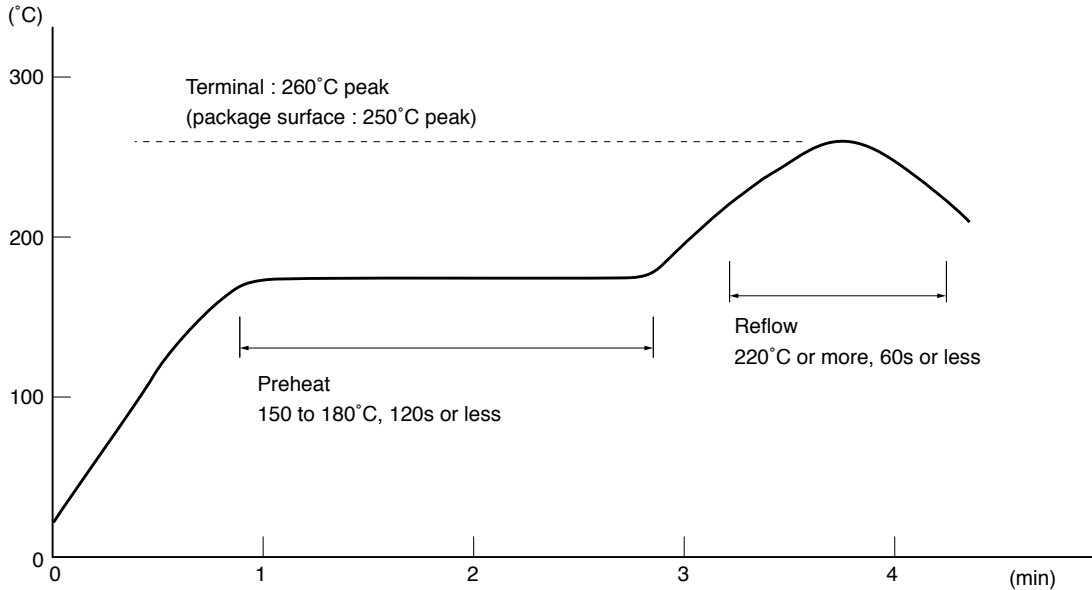

Flow Soldering :

Due to SHARP's double transfer mold construction submersion in flow solder bath is allowed under the below listed guidelines.

Flow soldering should be completed below 270°C and within 10s.
 Preheating is within the bounds of 100 to 150°C and 30 to 80s.
 Please don't solder more than twice.

Hand soldering

Hand soldering should be completed within 3s when the point of solder iron is below 400°C.
 Please don't solder more than twice.

Other notice

Please test the soldering method in actual condition and make sure the soldering works fine, since the impact on the junction between the device and PCB varies depending on the tooling and soldering conditions.

● Cleaning instructions**Solvent cleaning :**

Solvent temperature should be 45°C or below. Immersion time should be 3 minutes or less.

Ultrasonic cleaning :

The impact on the device varies depending on the size of the cleaning bath, ultrasonic output, cleaning time, size of PCB and mounting method of the device.

Therefore, please make sure the device withstands the ultrasonic cleaning in actual conditions in advance of mass production.

Recommended solvent materials :

Ethyl alcohol, Methyl alcohol and Isopropyl alcohol.

In case the other type of solvent materials are intended to be used, please make sure they work fine in actual using conditions since some materials may erode the packaging resin.

● Presence of ODC

This product shall not contain the following materials.

And they are not used in the production process for this product.

Regulation substances : CFCs, Halon, Carbon tetrachloride, 1.1.1-Trichloroethane (Methylchloroform)

Specific brominated flame retardants such as the PBB and PBDE are not used in this product at all.

This product shall not contain the following materials banned in the RoHS Directive (2002/95/EC).

•Lead, Mercury, Cadmium, Hexavalent chromium, Polybrominated biphenyls (PBB), Polybrominated diphenyl ethers (PBDE).

● Tape and Reel package

SMT Gullwing

Package materials

Carrier tape : PS

Cover tape : PET (three layer system)

Reel : PS

Carrier tape structure and Dimensions

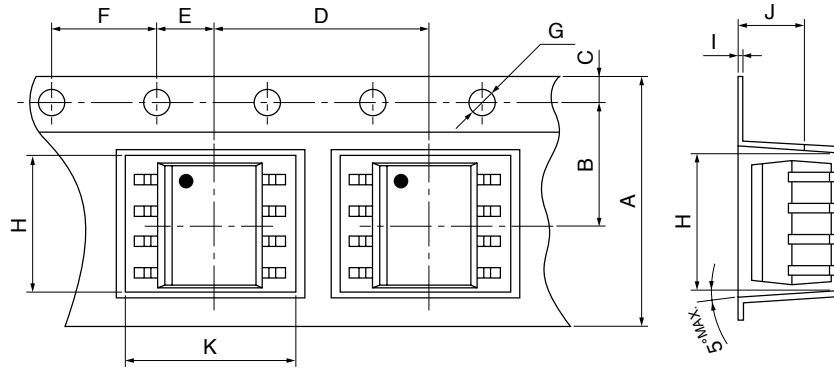

Dimensions List (Unit : mm)

A	B	C	D	E	F	G
12.0±0.3	5.50±0.05	1.75±0.10	8.0±0.1	2.00±0.05	4.0±0.1	φ1.55±0.05
H	I	J	K			
5.4±0.1	0.30±0.05	3.7±0.1	6.3±0.1			

Reel structure and Dimensions

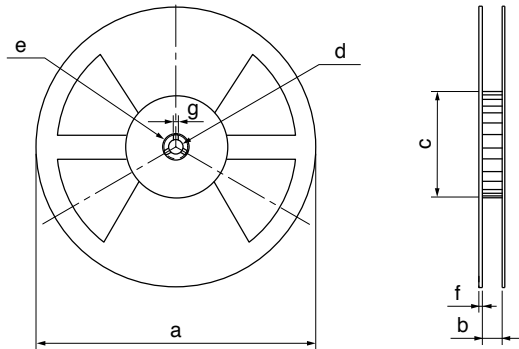

Dimensions List (Unit : mm)

a	b	c	d
φ330	13.5±1.5	φ100±1	φ13.0±0.2
e	f	g	
φ21.0±0.8	2.0 ^{TYP.}	2.0±0.5	

Direction of product insertion

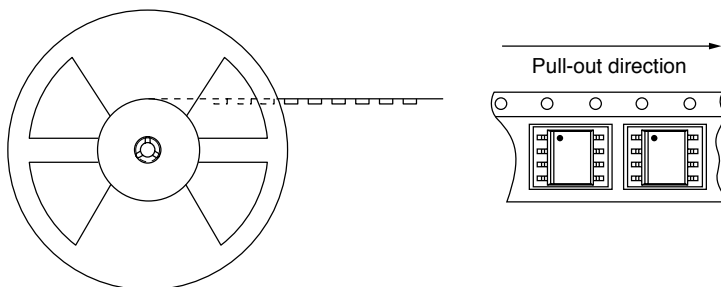

[Packing : 1 500pcs/reel]

■ Important Notices

· The circuit application examples in this publication are provided to explain representative applications of SHARP devices and are not intended to guarantee any circuit design or license any intellectual property rights. SHARP takes no responsibility for any problems related to any intellectual property right of a third party resulting from the use of SHARP's devices.

· Contact SHARP in order to obtain the latest device specification sheets before using any SHARP device. SHARP reserves the right to make changes in the specifications, characteristics, data, materials, structure, and other contents described herein at any time without notice in order to improve design or reliability. Manufacturing locations are also subject to change without notice.

· Observe the following points when using any devices in this publication. SHARP takes no responsibility for damage caused by improper use of the devices which does not meet the conditions and absolute maximum ratings to be used specified in the relevant specification sheet nor meet the following conditions:

(i) The devices in this publication are designed for use in general electronic equipment designs such as:

- Personal computers
- Office automation equipment
- Telecommunication equipment [terminal]
- Test and measurement equipment
- Industrial control
- Audio visual equipment
- Consumer electronics

(ii) Measures such as fail-safe function and redundant design should be taken to ensure reliability and safety when SHARP devices are used for or in connection

with equipment that requires higher reliability such as:

- Transportation control and safety equipment (i.e., aircraft, trains, automobiles, etc.)
- Traffic signals
- Gas leakage sensor breakers
- Alarm equipment
- Various safety devices, etc.

(iii) SHARP devices shall not be used for or in connection with equipment that requires an extremely high level of reliability and safety such as:

- Space applications
- Telecommunication equipment [trunk lines]
- Nuclear power control equipment
- Medical and other life support equipment (e.g., scuba).

· If the SHARP devices listed in this publication fall within the scope of strategic products described in the Foreign Exchange and Foreign Trade Law of Japan, it is necessary to obtain approval to export such SHARP devices.

· This publication is the proprietary product of SHARP and is copyrighted, with all rights reserved. Under the copyright laws, no part of this publication may be reproduced or transmitted in any form or by any means, electronic or mechanical, for any purpose, in whole or in part, without the express written permission of SHARP. Express written permission is also required before any use of this publication may be made by a third party.

· Contact and consult with a SHARP representative if there are any questions about the contents of this publication.

OUR CERTIFICATE

DiGi provide top-quality products and perfect service for customer worldwide through standardization, technological innovation and continuous improvement. DiGi through third-party certification, we stricly control the quality of products and services. Welcome your RFQ to

Email: Info@DiGi-Electronics.com



Tel: +00 852-30501935

RFQ Email: Info@DiGi-Electronics.com

DiGi is a global authorized distributor of electronic components.