

PQ1X331M2ZP Datasheet

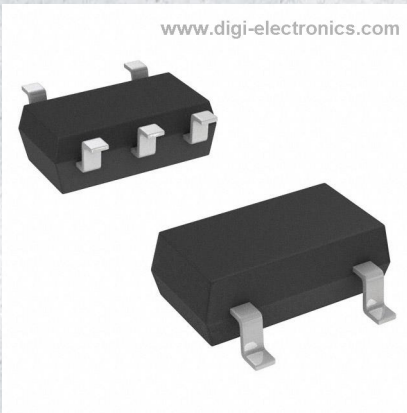

<https://www.DiGi-Electronics.com>

DiGi Electronics Part Number	PQ1X331M2ZP-DG
Manufacturer	Sharp Microelectronics
Manufacturer Product Number	PQ1X331M2ZP
Description	IC REG LINEAR 3.3V 150MA SOT23-5
Detailed Description	Linear Voltage Regulator IC Positive Fixed 1 Output 150mA SOT-23-5

This model PQ1X331M2ZP is available at DiGi Electronics.

DiGi Electronics offers a global database of semiconductor and electronic component datasheets.

We welcome your inquiries regarding pricing, lead time, or other product-related questions.

 [Request a Quote](#)

 [Datasheet Search](#)



Tel: +00 852-30501935

RFQ Email: Info@DiGi-Electronics.com

DiGi is a global authorized distributor of electronic components.

Purchase and inquiry

Manufacturer Product Number:

PQ1X331M2ZP

Series:

-

Output Configuration:

Positive

Number of Regulators:

1

Voltage - Output (Min/Fixed):

3.3V

Voltage Dropout (Max):

0.4V @ 150mA

Current - Quiescent (Iq):

200 μ A

Control Features:

Enable

Operating Temperature:

-30°C ~ 85°C

Package / Case:

SC-74A, SOT-753

Base Product Number:

PQ1X

Manufacturer:

Sharp Microelectronics

Product Status:

Obsolete

Output Type:

Fixed

Voltage - Input (Max):

9V

Voltage - Output (Max):

-

Current - Output:

150mA

PSRR:

70dB (400Hz)

Protection Features:

Over Current, Over Temperature

Mounting Type:

Surface Mount

Supplier Device Package:

SOT-23-5

Environmental & Export classification

RoHS Status:

RoHS non-compliant

ECCN:

EAR99

Moisture Sensitivity Level (MSL):

1 (Unlimited)

HTSUS:

8542.39.0001

PQ1Xxx1M2ZP Series

Low Output Current, Compact Surface Mount Type Low Power-Loss Voltage Regulators

Features

- Compact surface mount package (2.9×1.6×1.1mm)
- Low power-loss
(Dropout voltage: TYP. 0.11 V/MAX. 0.26V at I_o=60mA)
- Also compatible ceramic capacitors because of suppressing oscillation level
- High ripple rejection (TYP. 70dB)
- Low dissipation current
(Dissipation current at no load: TYP. 150μA)
- Built-in ON/OFF control function
(Dissipation current at OFF-state: MAX. 1μA)
- Built-in overcurrent and overheat protection functions

*It is available for every 0.1V of output voltage (1.3V to 5.0V)

Applications

- Cellular phones
- Cordless phones
- Personal information tools
- Cameras/Camcoders
- PCMCIA cards for notebook PCs

Model Line-up

Output Voltage (TYP.)	Model No.	Output Voltage (TYP.)	Model No.
2.5V	PQ1X251M2ZP	3.8V	PQ1X381M2ZP
2.8V	PQ1X281M2ZP	4.0V	PQ1X401M2ZP
3.0V	PQ1X301M2ZP	4.2V	PQ1X421M2ZP
3.3V	PQ1X331M2ZP	4.5V	PQ1X451M2ZP
3.6V	PQ1X361M2ZP	5.0V	PQ1X501M2ZP

Absolute Maximum Ratings

(T_a=25°C)

Parameter	Symbol	Rating	Unit
*1 Input voltage	V _{IN}	9	V
*0 ON/OFF control terminal voltage	V _C	9	V
Output current	I _o	300	mA
*2 Power dissipation	P _D	350	mW
*3 Junction temperature	T _j	150	°C
Operating temperature	T _{opr}	-30 to +80	°C
Storage temperature	T _{stg}	-55 to +150	°C
Soldering temperature	T _{sol}	260 (10s)	°C

*1 All are open except GND and applicable terminals

*2 At mounted on PCB

*3 Overheat protection may operate at T_j:125°C to 150°C

Outline Dimensions

(Unit : mm)

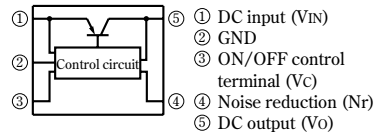
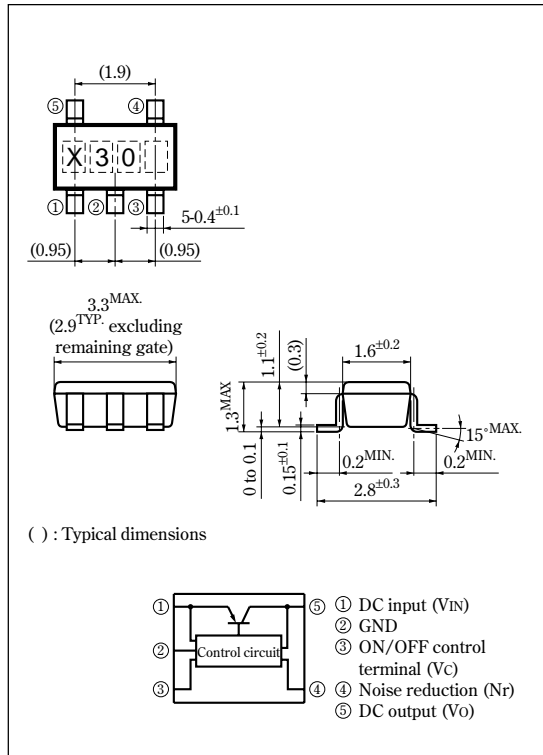

•Please refer to the chapter " Handling Precautions ".

SHARP

Electrical Characteristics

(Unless otherwise specified, $V_{IN}=V_O(TYP)+1.0V$, $I_O=30mA$, $V_C=1.8V$, $T_a=25^\circ C$)

Parameter	Symbol	Conditions	MIN.	TYP.	MAX.	Unit
Output voltage	V_O	—	Refer to the following table.1			V
*4 Output peak current	I_{op}	—	180	300	—	mA
Recommended output current	—	—	—	—	150	mA
Load regulation	R_{egL1}	$I_O=5$ to 60mA	—	10	50	mV
	R_{egL2}	$I_O=5$ to 100mA	—	20	100	mV
	R_{egL3}	$I_O=5$ to 150mA	—	40	160	mV
Line regulation	R_{egI}	$V_{IN}=V_O(TYP)+1V$ to $V_O(TYP)+6V$ (MAX. 9.0V)	—	3.0	20	mV
Temperature coefficient of output voltage	TcV_O	$I_O=10mA$, $T_j=-25$ to $+75^\circ C$	—	0.05	—	mV/ $^\circ C$
Ripple rejection	RR	Refer to Fig.2	—	70	—	dB
Output noise voltage	$V_{no(rms)}$	$10Hz < f < 100kHz$, $C_n=0.1\mu F$, $I_O=30mA$	Refer to the following table.2			μV
Dropout voltage	V_{I-O1}	$I_O=60mA$ *5	—	0.11	0.26	V
	V_{I-O2}	$I_O=150mA$ *5	—	0.20	0.4	
*6 ON-state voltage for control	$V_C(ON)$	—	1.8	—	—	V
ON-state current for control	$I_C(ON)$	$V_C=1.8V$	—	5	30	μA
OFF-state voltage for control	$V_C(OFF)$	—	—	—	0.4	V
Quiescent current	I_q	$I_O=0mA$	—	150	200	μA
Output OFF-state dissipation current	I_{qs}	$V_C=0.2V$	—	—	1	μA

*4 Output current shall be the value when output voltage lowers 0.3V from the voltage at $I_O=30mA$.

*5 Input voltage when output voltage falls 0.1V from that at $V_{IN}=V_O(TYP)+1.0V$.

*6 In case that the control terminal (③ pin) is open, output voltage should be OFF state.

Table.1 Output Voltage Line-up

($V_{IN}=V_O(TYP)+1.0V$, $I_O=30mA$, $V_C=1.8V$, $T_a=25^\circ C$)

Model No.	Symbol	MIN.	TYP.	MAX.	Unit
PQ1X251M2ZP	V_O	2.440	2.5	2.560	V
PQ1X281M2ZP	V_O	2.740	2.8	2.860	V
PQ1X301M2ZP	V_O	2.940	3.0	3.060	V
PQ1v331M2ZP	V_O	3.234	3.3	3.366	V
PQ1X361M2ZP	V_O	3.528	3.6	3.672	V
PQ1X381M2ZP	V_O	3.724	3.8	3.876	V
PQ1X401M2ZP	V_O	3.920	4.0	4.080	V
PQ1X421M2ZP	V_O	4.116	4.2	4.284	V
PQ1X451M2ZP	V_O	4.410	4.5	4.590	V
PQ1X501M2ZP	V_O	4.900	5.0	5.100	V

Table.2 Output Noise Voltage Line-up

($V_{IN}=V_O(TYP)+1.0V$, $I_O=30mA$, $V_C=1.8V$, $C_n=0.1\mu F$, $10Hz < f < 100kHz$, $T_a=25^\circ C$)

Model No.	Symbol	MIN.	TYP.	MAX.	Unit
PQ1X251M2ZP	$V_{no(rms)}$	—	25	—	μV
PQ1X281M2ZP	$V_{no(rms)}$	—	25	—	μV
PQ1X301M2ZP	$V_{no(rms)}$	—	30	—	μV
PQ1X331M2ZP	$V_{no(rms)}$	—	30	—	μV
PQ1X361M2ZP	$V_{no(rms)}$	—	35	—	μV
PQ1X381M2ZP	$V_{no(rms)}$	—	35	—	μV
PQ1X401M2ZP	$V_{no(rms)}$	—	40	—	μV
PQ1X421M2ZP	$V_{no(rms)}$	—	40	—	μV
PQ1X451M2ZP	$V_{no(rms)}$	—	45	—	μV
PQ1X501M2ZP	$V_{no(rms)}$	—	50	—	μV

Fig.1 Test Circuit

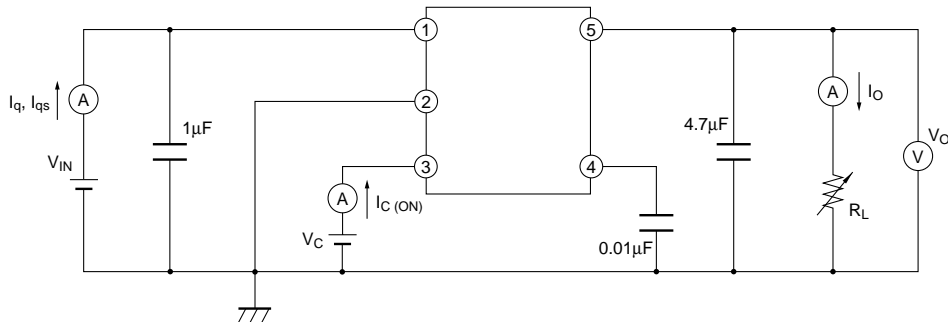

Fig.2 Test Circuit for Ripple Rejection

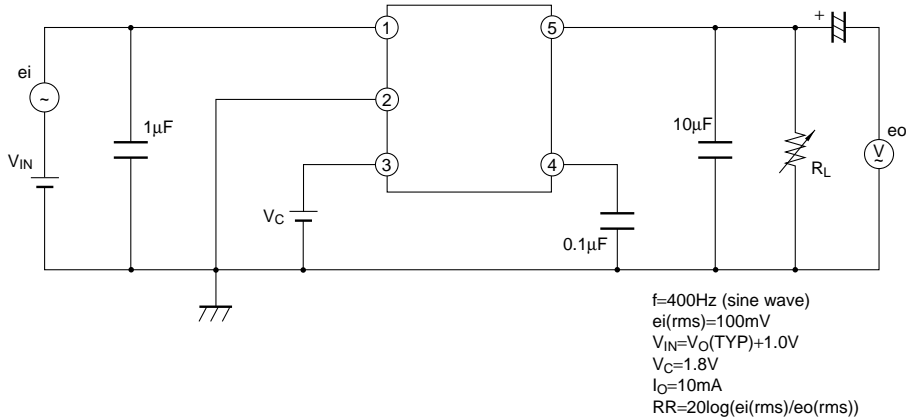
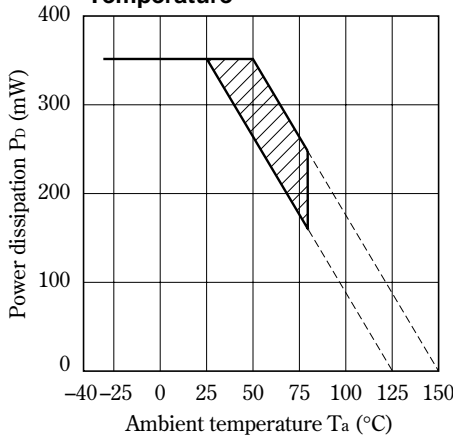

Fig.3 Power Dissipation vs. Ambient Temperature



Note) Oblique line portion: Overheat protection may operate in this area.

Fig.5 Output Voltage Fluctuation vs. Junction Temperature (PQ1X301M2ZP)(Typical Value)

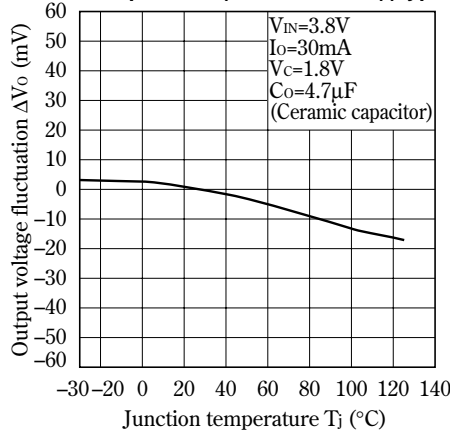

Fig.4 Overcurrent Protection Characteristics (Typical Value)

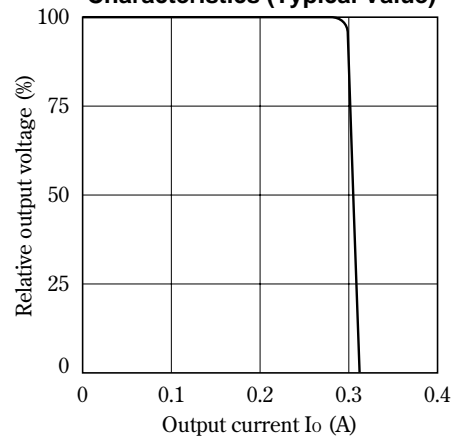

Fig.6 Output Voltage vs. Input Voltage (PQ1X301M2ZP)(Typical Value)

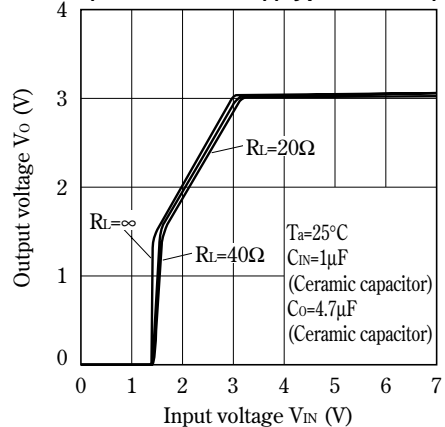

Fig.7 Circuit Operating Current vs. Input Voltage (PQ1X301M2ZP)(Typical Value)

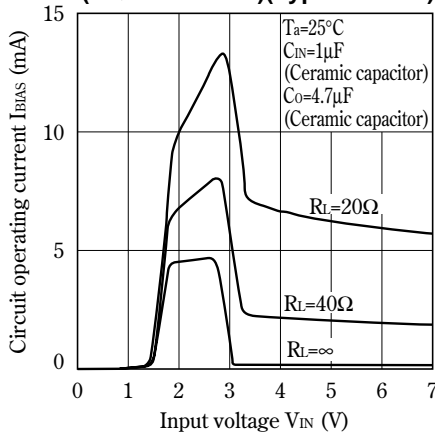

Fig.8 Dropout Voltage vs. Junction Temperature (PQ1X301M2ZP)(Typical Value)

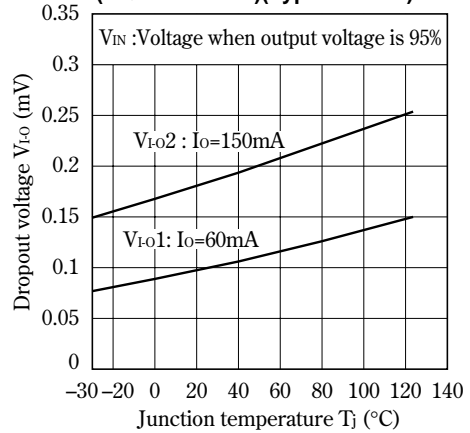

Fig.9 Quiescent Current vs. Junction Temperature (Typical Value)

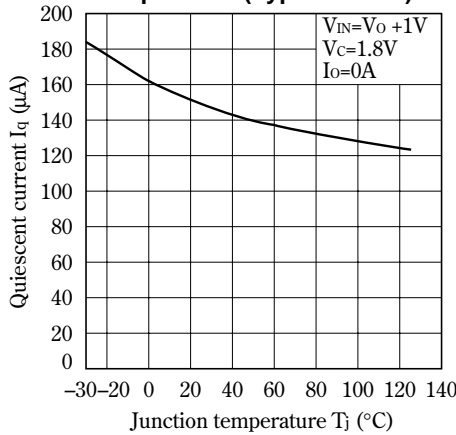

Fig.10 Ripple Rejection vs. Input Ripple Frequency (PQ1X281M2ZP)(Typical Value)

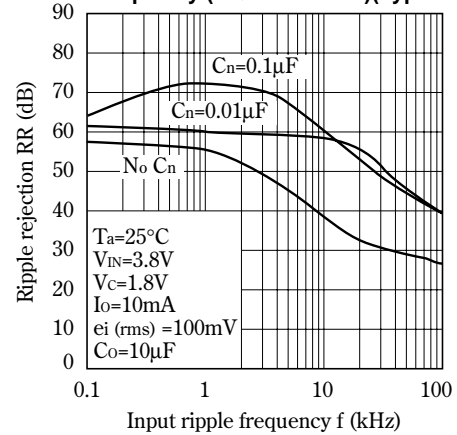
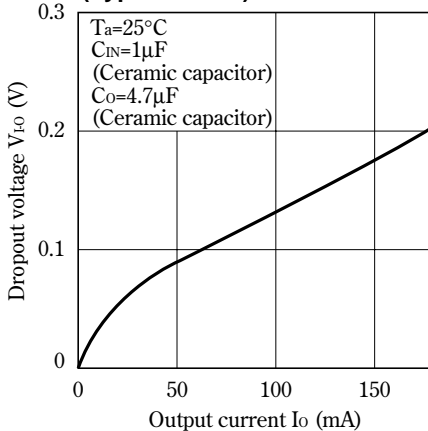

Fig.11 Dropout Voltage vs. Output Current (Typical Value)



NOTICE

- The circuit application examples in this publication are provided to explain representative applications of SHARP devices and are not intended to guarantee any circuit design or license any intellectual property rights. SHARP takes no responsibility for any problems related to any intellectual property right of a third party resulting from the use of SHARP's devices.
- Contact SHARP in order to obtain the latest device specification sheets before using any SHARP device. SHARP reserves the right to make changes in the specifications, characteristics, data, materials, structure, and other contents described herein at any time without notice in order to improve design or reliability. Manufacturing locations are also subject to change without notice.
- Observe the following points when using any devices in this publication. SHARP takes no responsibility for damage caused by improper use of the devices which does not meet the conditions and absolute maximum ratings to be used specified in the relevant specification sheet nor meet the following conditions:
 - (i) The devices in this publication are designed for use in general electronic equipment designs such as:
 - Personal computers
 - Office automation equipment
 - Telecommunication equipment [terminal]
 - Test and measurement equipment
 - Industrial control
 - Audio visual equipment
 - Consumer electronics
 - (ii) Measures such as fail-safe function and redundant design should be taken to ensure reliability and safety when SHARP devices are used for or in connection with equipment that requires higher reliability such as:
 - Transportation control and safety equipment (i.e., aircraft, trains, automobiles, etc.)
 - Traffic signals
 - Gas leakage sensor breakers
 - Alarm equipment
 - Various safety devices, etc.
 - (iii) SHARP devices shall not be used for or in connection with equipment that requires an extremely high level of reliability and safety such as:
 - Space applications
 - Telecommunication equipment [trunk lines]
 - Nuclear power control equipment
 - Medical and other life support equipment (e.g., scuba).
- Contact a SHARP representative in advance when intending to use SHARP devices for any "specific" applications other than those recommended by SHARP or when it is unclear which category mentioned above controls the intended use.
- If the SHARP devices listed in this publication fall within the scope of strategic products described in the Foreign Exchange and Foreign Trade Control Law of Japan, it is necessary to obtain approval to export such SHARP devices.
- This publication is the proprietary product of SHARP and is copyrighted, with all rights reserved. Under the copyright laws, no part of this publication may be reproduced or transmitted in any form or by any means, electronic or mechanical, for any purpose, in whole or in part, without the express written permission of SHARP. Express written permission is also required before any use of this publication may be made by a third party.
- Contact and consult with a SHARP representative if there are any questions about the contents of this publication.

OUR CERTIFICATE

DiGi provide top-quality products and perfect service for customer worldwide through standardization, technological innovation and continuous improvement. DiGi through third-party certification, we stricly control the quality of products and services. Welcome your RFQ to

Email: Info@DiGi-Electronics.com



Tel: +00 852-30501935

RFQ Email: Info@DiGi-Electronics.com

DiGi is a global authorized distributor of electronic components.