

PT480F Datasheet



<https://www.DiGi-Electronics.com>

DiGi Electronics Part Number	PT480F-DG
Manufacturer	Sharp Microelectronics
Manufacturer Product Number	PT480F
Description	SENSOR PHOTO 860NM SIDE VIEW RAD
Detailed Description	Phototransistors 860nm Side View Radial

This model PT480F is available at DiGi Electronics.

DiGi Electronics offers a global database of semiconductor and electronic component datasheets.

We welcome your inquiries regarding pricing, lead time, or other product-related questions.

 [Request a Quote](#)

 [Datasheet Search](#)



Tel: +00 852-30501935

RFQ Email: Info@DiGi-Electronics.com

DiGi is a global authorized distributor of electronic components.

Purchase and inquiry

Manufacturer Product Number:

PT480F

Series:

-

Voltage - Collector Emitter Breakdown (Max):

35 V

Current - Dark (I_d) (Max):

100 nA

Viewing Angle:

70°

Mounting Type:

Through Hole

Operating Temperature:

-25°C ~ 85°C (TA)

Manufacturer:

Sharp Microelectronics

Product Status:

Obsolete

Current - Collector (I_c) (Max):

20 mA

Wavelength:

860nm

Power - Max:

75 mW

Orientation:

Side View

Package / Case:

Radial

Environmental & Export classification

RoHS Status:

RoHS non-compliant

ECCN:

EAR99

Moisture Sensitivity Level (MSL):

1 (Unlimited)

HTSUS:

8541.49.7080

PT480/PT480F

Narrow Acceptance Phototransistor

■ Features

1. Epoxy resin package
2. Narrow acceptance ($\Delta\theta$: TYP. $\pm 13^\circ$)
3. Visible light cut-off type : **PT480F**

■ Applications

1. VCRs, cassette tape recorders
2. Floppy disk drives
3. Optoelectronic switches
4. Automatic stroboscopes

■ Outline Dimensions

(Unit : mm)

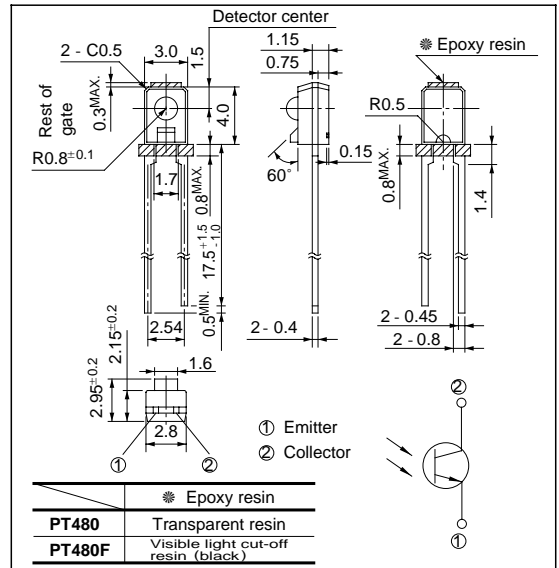

■ Absolute Maximum Ratings

(Ta = 25°C)

Parameter	Symbol	Rating	Unit
Collector-emitter voltage	V _{CEO}	35	V
Emitter-collector voltage	V _{ECO}	6	V
Collector current	I _C	20	mA
Collector power dissipation	P _C	75	mW
Operating temperature	T _{opr}	- 25 to +85	°C
Storage temperature	T _{stg}	- 40 to +85	°C
*1 Soldering temperature	T _{sol}	260	°C

*1 For 5 seconds at the position of 1.4mm from the bottom face of resin package

■ Electro-optical Characteristics

(Ta = 25°C)

Parameter	Symbol	Conditions	MIN.	TYP.	MAX.	Unit
*2 Collector current	I _C	V _{CE} = 5V	0.4	1.7	6.0	mA
		E _e = 1mW/cm ²	0.25	0.8	3.0	mA
Collector dark current	I _{CEO}	V _{CE} = 20V, E _e = 0	-	10 ⁻⁹	10 ⁻⁷	A
*2 Collector-emitter saturation voltage	V _{CE(sat)}	I _C = 0.5mA, E _e = 10mW/cm ²	-	0.1	0.4	V
Peak sensitivity wavelength	λ _P	-	-	800	-	nm
			-	860	-	nm
Response time	Rise time	V _{CE} = 2V, I _C = 2mA	-	3	-	μs
	Fall time	R _L = 100Ω	-	3.5	-	μs

*2 E_e : Irradiance by CIE standard light source A (tungsten lamp)

Fig. 1 Collector Power Dissipation vs. Ambient Temperature

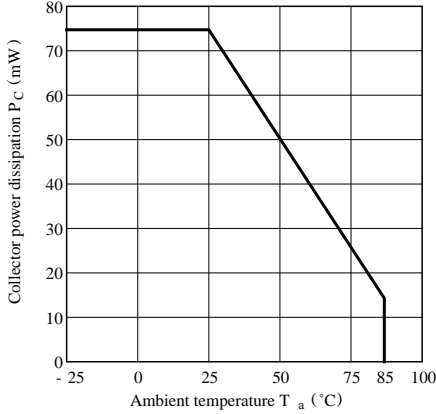

Fig. 2 Collector Dark Current vs. Ambient Temperature

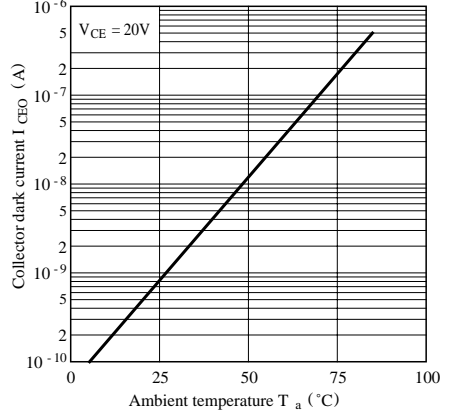

Fig. 3 Relative Collector Current vs. Ambient Temperature

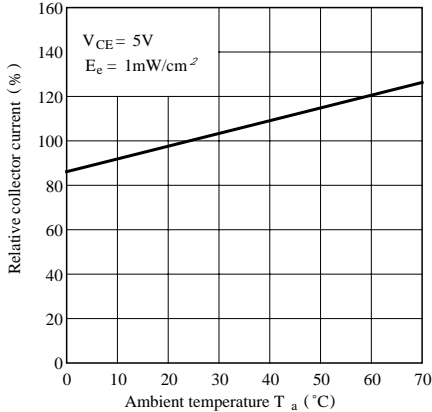

Fig.4-a Collector Current vs. Irradiance (PT480)

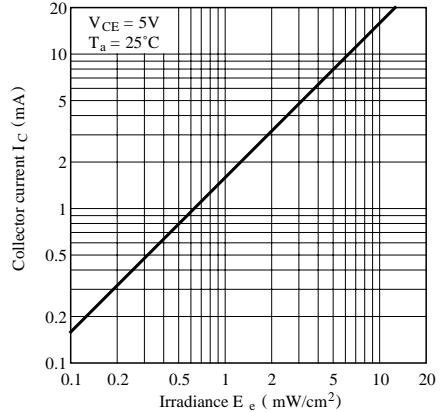

Fig.4-b Collector Current vs. Irradiance (PT480F)

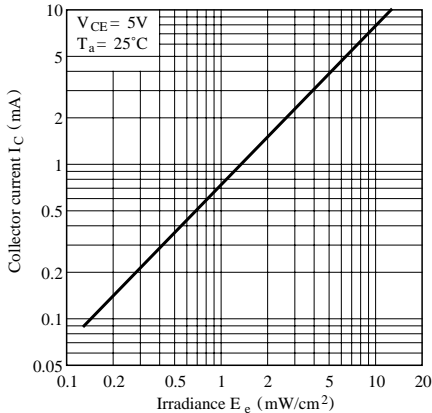

Fig.5-a Collector Current vs. Collector-emitter Voltage (PT480)

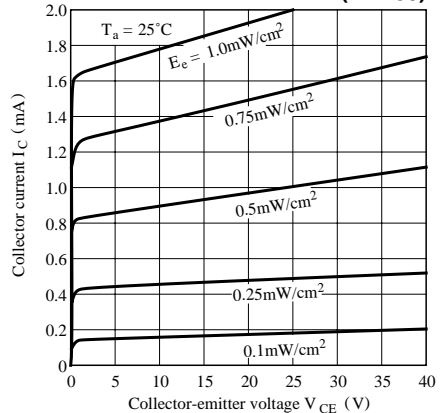

Fig.5-b Collector Current vs. Collector-emitter Voltage (PT480F)

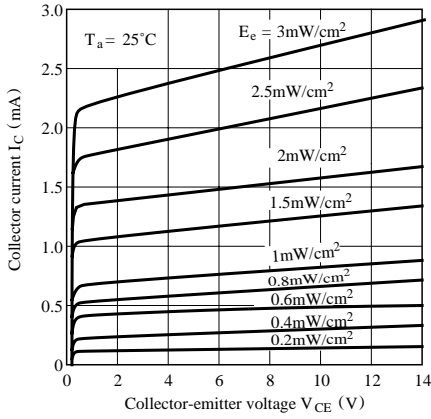

Fig. 6 Spectral Sensitivity

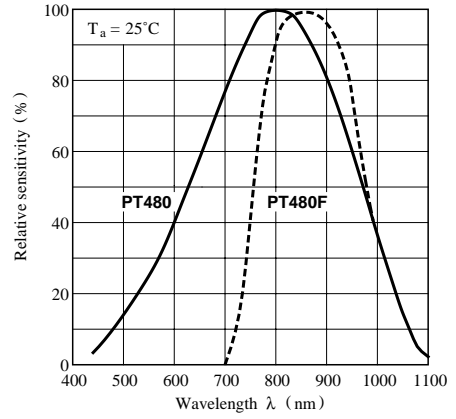
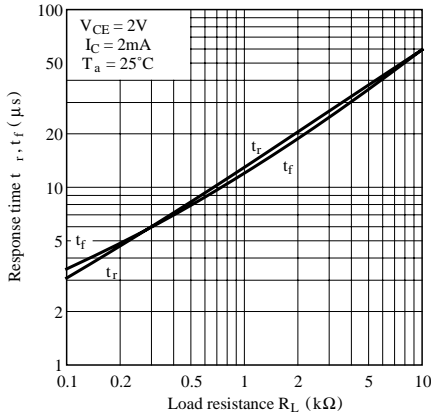

Fig. 7 Response Time vs. Load Resistance



Test Circuit for Response Time

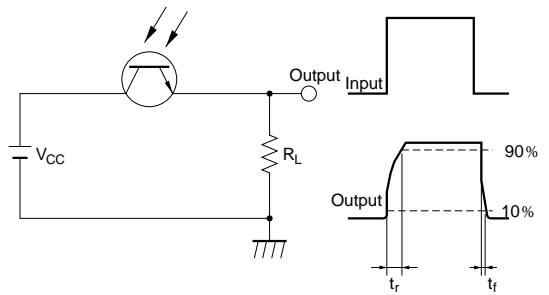

Fig. 8 Sensitivity Diagram (T_a = 25°C)

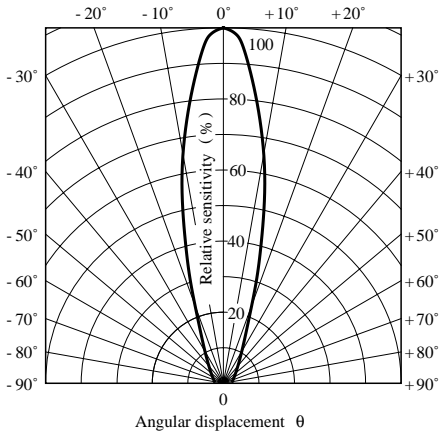

Fig.9-a Collector-emitter Saturation Voltage vs. Irradiance (PT480)

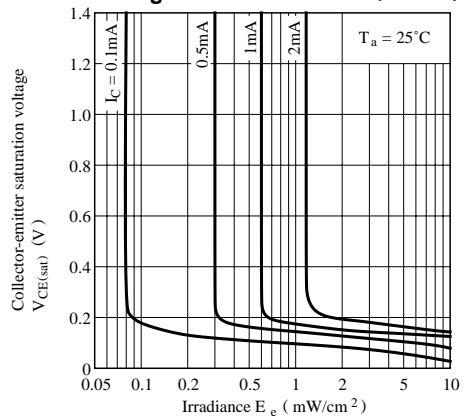

Fig.9-b Collector-emitter Saturation Voltage vs. Irradiance (PT480F)

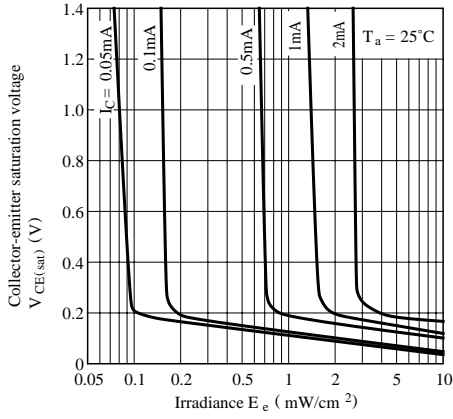
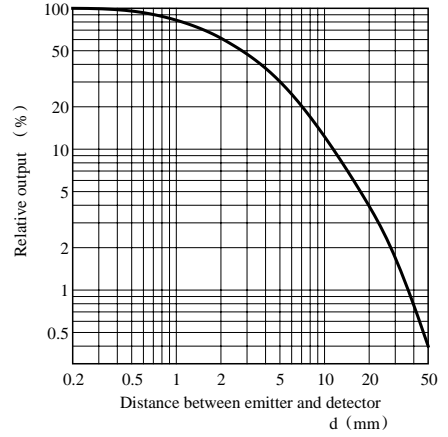

Fig.10 Relative Output vs. Distance (Emitter : GL480)



Please refer to the chapter “Precautions for Use.”

NOTICE

- The circuit application examples in this publication are provided to explain representative applications of SHARP devices and are not intended to guarantee any circuit design or license any intellectual property rights. SHARP takes no responsibility for any problems related to any intellectual property right of a third party resulting from the use of SHARP's devices.
- Contact SHARP in order to obtain the latest device specification sheets before using any SHARP device. SHARP reserves the right to make changes in the specifications, characteristics, data, materials, structure, and other contents described herein at any time without notice in order to improve design or reliability. Manufacturing locations are also subject to change without notice.
- Observe the following points when using any devices in this publication. SHARP takes no responsibility for damage caused by improper use of the devices which does not meet the conditions and absolute maximum ratings to be used specified in the relevant specification sheet nor meet the following conditions:
 - (i) The devices in this publication are designed for use in general electronic equipment designs such as:
 - Personal computers
 - Office automation equipment
 - Telecommunication equipment [terminal]
 - Test and measurement equipment
 - Industrial control
 - Audio visual equipment
 - Consumer electronics
 - (ii) Measures such as fail-safe function and redundant design should be taken to ensure reliability and safety when SHARP devices are used for or in connection with equipment that requires higher reliability such as:
 - Transportation control and safety equipment (i.e., aircraft, trains, automobiles, etc.)
 - Traffic signals
 - Gas leakage sensor breakers
 - Alarm equipment
 - Various safety devices, etc.
 - (iii) SHARP devices shall not be used for or in connection with equipment that requires an extremely high level of reliability and safety such as:
 - Space applications
 - Telecommunication equipment [trunk lines]
 - Nuclear power control equipment
 - Medical and other life support equipment (e.g., scuba).
- Contact a SHARP representative in advance when intending to use SHARP devices for any "specific" applications other than those recommended by SHARP or when it is unclear which category mentioned above controls the intended use.
- If the SHARP devices listed in this publication fall within the scope of strategic products described in the Foreign Exchange and Foreign Trade Control Law of Japan, it is necessary to obtain approval to export such SHARP devices.
- This publication is the proprietary product of SHARP and is copyrighted, with all rights reserved. Under the copyright laws, no part of this publication may be reproduced or transmitted in any form or by any means, electronic or mechanical, for any purpose, in whole or in part, without the express written permission of SHARP. Express written permission is also required before any use of this publication may be made by a third party.
- Contact and consult with a SHARP representative if there are any questions about the contents of this publication.

OUR CERTIFICATE

DiGi provide top-quality products and perfect service for customer worldwide through standardization, technological innovation and continuous improvement. DiGi through third-party certification, we stricly control the quality of products and services. Welcome your RFQ to

Email: Info@DiGi-Electronics.com



Tel: +00 852-30501935

RFQ Email: Info@DiGi-Electronics.com

DiGi is a global authorized distributor of electronic components.