

CP2120-GMR Datasheet

www.digi-electronics.com

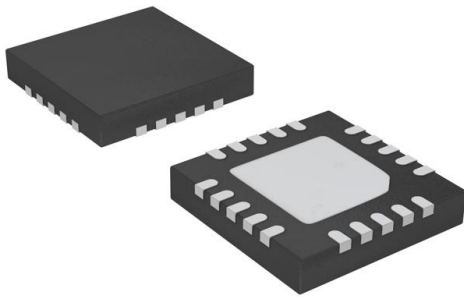

DiGi Electronics Part Number	CP2120-GMR-DG
Manufacturer	Silicon Labs
Manufacturer Product Number	CP2120-GMR
Description	IC XPNDR 400KHZ I2C SPI 20QFN
Detailed Description	I/O Expander 8 I2C, SPI 400 kHz 20-QFN (4x4)

<https://www.DiGi-Electronics.com>



Tel: +00 852-30501935

RFQ Email: Info@DiGi-Electronics.com

DiGi is a global authorized distributor of electronic components.

Purchase and inquiry

Manufacturer Product Number:

CP2120-GMR

Series:

-

DiGi-Electronics Programmable:

Not Verified

Interface:

I2C, SPI

Features:

-

Current - Output Source/Sink:

100mA

Voltage - Supply:

3V ~ 3.6V

Mounting Type:

Surface Mount

Supplier Device Package:

20-QFN (4x4)

Manufacturer:

Silicon Labs

Product Status:

Obsolete

Number of I/O:

8

Interrupt Output:

Yes

Output Type:

Open Drain, Push-Pull

Clock Frequency:

400 kHz

Operating Temperature:

-40°C ~ 85°C

Package / Case:

20-VFQFN Exposed Pad

Base Product Number:

CP2120

Environmental & Export classification

Moisture Sensitivity Level (MSL):

1 (Unlimited)

HTSUS:

8542.39.0001

ECCN:

EAR99

SPI TO I²C BRIDGE AND GPIO PORT EXPANDER

Single Chip SPI to I²C Transfer

- Integrated clock; no external clock required
- On-Chip Voltage Monitor

Slave Serial Peripheral Interface (SPI)

- Up to 1.0 Mbit/s Transfers
- Configurable to Least Significant Bit or Most Significant Bit first byte transfers

I²C Master Interface

- Operates at configurable rates up to 400 kHz
- 255 RX and TX Data Buffers

Input and Output Port Pins

- 8 Pins Configurable as Push-Pull or Open-Drain
- 1 Pin Configurable as an edge-triggered interrupt source
- All pins 5 V Tolerant
- INT active low interrupt pin

Supply Voltage of 2.7 V to 3.6 V

- Typical operating current: 6.4 mA

Package

- Pb-free 20-pin QFN

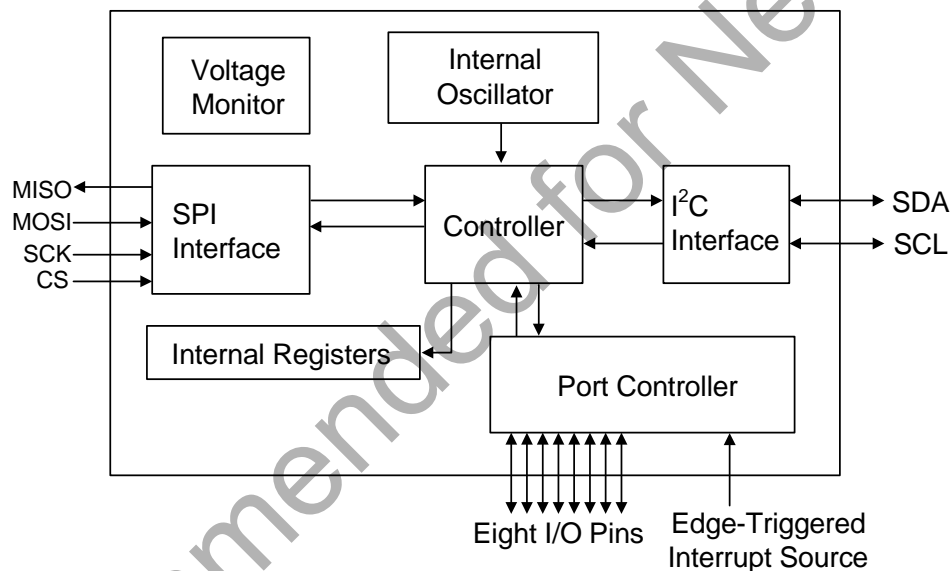

Figure 1. Block Diagram

CP2120

Not Recommended for New Designs

TABLE OF CONTENTS

<u>Section</u>	<u>Page</u>
1. System Overview	4
2. Global DC Electrical Characteristics	4
3. Absolute Maximum Ratings	4
4. Pinout And Package Definition	5
4.1. Pin Out Chart	5
4.2. QFN-20 Pinout Diagram (Top View)	6
4.3. QFN-20 Pinout Diagram (Bottom View)	7
4.4. QFN-20 Solder Paste Recommendations	8
5. SPI Slave Bus	9
5.1. Command Set	10
5.2. Internal Registers	10
5.3. SPI Byte Orientation	11
5.4. SPI Timing Diagrams	11
5.5. I ² C Activity During SPI Transactions	12
6. I²C Serial Interface	13
6.1. Determining Pull-Up Register Values	13
6.2. I ² C Internal Registers	13
6.3. I ² C Status	15
6.4. I ² C Receive Buffer Size	17
6.5. I ² C Commands	17
7. Port I/O	19
8. CP2120 Revision Number	22
Document Change List	23
Contact Information	24

CP2120

1. System Overview

The CP2120 is a highly-integrated SPI-to-I²C Bridge Controller with an SPI interface that provides a simple and reliable method for communicating with I²C devices. The CP2120 includes a 4-wire serial peripheral interface (SPI), a serial I²C interface, 256 byte data buffers, an internal oscillator, eight input/output port pins, and one pin configurable as an edge-triggered interrupt source in a compact 4x4 package. No external components other than pull-up resistors on the I²C pins are required. The SPI Master controls the CP2120 across the SPI interface using a command set that governs all CP2120 configuration and operation.

2. Global DC Electrical Characteristics

Table 1. Global Electrical Characteristics

–40 to +85 °C, 25 MHz system clock unless otherwise specified.

Parameter	Test Condition	Min	Typ	Max	Unit
Digital Supply Voltage		V _{RST}	3.0	3.6	V
Digital Supply Current	V _{DD} = 3.0 V	—	3.8	4.1	mA
Specified Operating Temperature Range		–40	—	+85	°C
V _{DD} POR Threshold (V _{RST})		2.40	2.55	2.70	V

3. Absolute Maximum Ratings

Table 2. Absolute Maximum Ratings

Parameter	Test Condition	Min	Typ	Max	Unit
Ambient temperature under bias		–55	—	125	°C
Storage Temperature		–65	—	150	°C
Voltage on any Port I/O Pin or $\overline{\text{RST}}$ with respect to GND		–0.3	—	5.8	V
Voltage on V _{DD} with respect to GND		–0.3	—	4.2	V
Maximum Total current through V _{DD} or GND		—	—	500	mA
Maximum output current sunk by $\overline{\text{RST}}$ or any Port pin		—	—	100	mA
<p>Note: Stresses above the absolute maximum ratings may cause permanent device damage. This is a stress rating only, and functional operation of the devices at any conditions equal to or greater than those indicated in the operational listings of this specification are not implied. Exposure to maximum rating conditions for extended periods may affect device reliability.</p>					

4. Pinout And Package Definition

4.1. Pin Out Chart

Name	Pin #	Type	Description
V _{DD}	3		Power Supply Pin
GND	2		Ground
$\overline{\text{RST}}$	4	Digital I/O	Device Reset. Open-drain output of internal POR or V _{DD} monitor. An external source can initiate a system reset by driving this pin low for at least 15 μs .
SCLK	1	Digital In	SPI Clock Input
MISO	20	Digital Out	SPI Slave Output
MOSI	19	Digital In	SPI Slave Input
$\overline{\text{CS}}$	18	Digital In	SPI Slave Select
SDA	17	Digital I/O	I ² C Data Input/Output
SCL	16	Digital I/O	I ² C Clock Input/Output
GPIO 0	5	Digital I/O	General Purpose Configurable Digital Input/Output
GPIO 1	12	Digital I/O	General Purpose Configurable Digital Input/Output
GPIO 2	11	Digital I/O	General Purpose Configurable Digital Input/Output
GPIO 3	10	Digital I/O	General Purpose Configurable Digital Input/Output
GPIO 4	9	Digital I/O	General Purpose Configurable Digital Input/Output
GPIO 5	8	Digital I/O	General Purpose Configurable Digital Input/Output
GPIO 6	7	Digital I/O	General Purpose Configurable Digital Input/Output
GPIO 7	6	Digital I/O	General Purpose Configurable Digital Input/Output
EINT	13	Digital I/O	Edge-Triggered Interrupt Source
$\overline{\text{INT}}$	14	Digital Out	CP2120 Interrupt Indicator
NC	15	Digital Out	Not connected, leave floating

CP2120

4.2. QFN-20 Pinout Diagram (Top View)

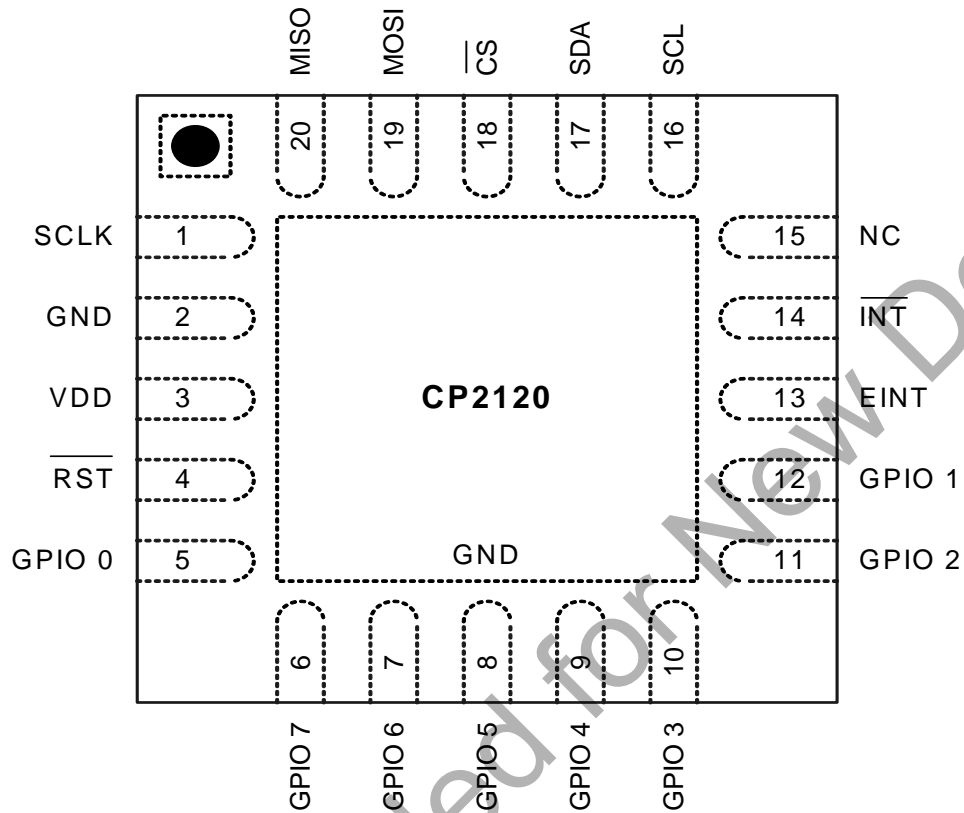

4.3. QFN-20 Pinout Diagram (Bottom View)

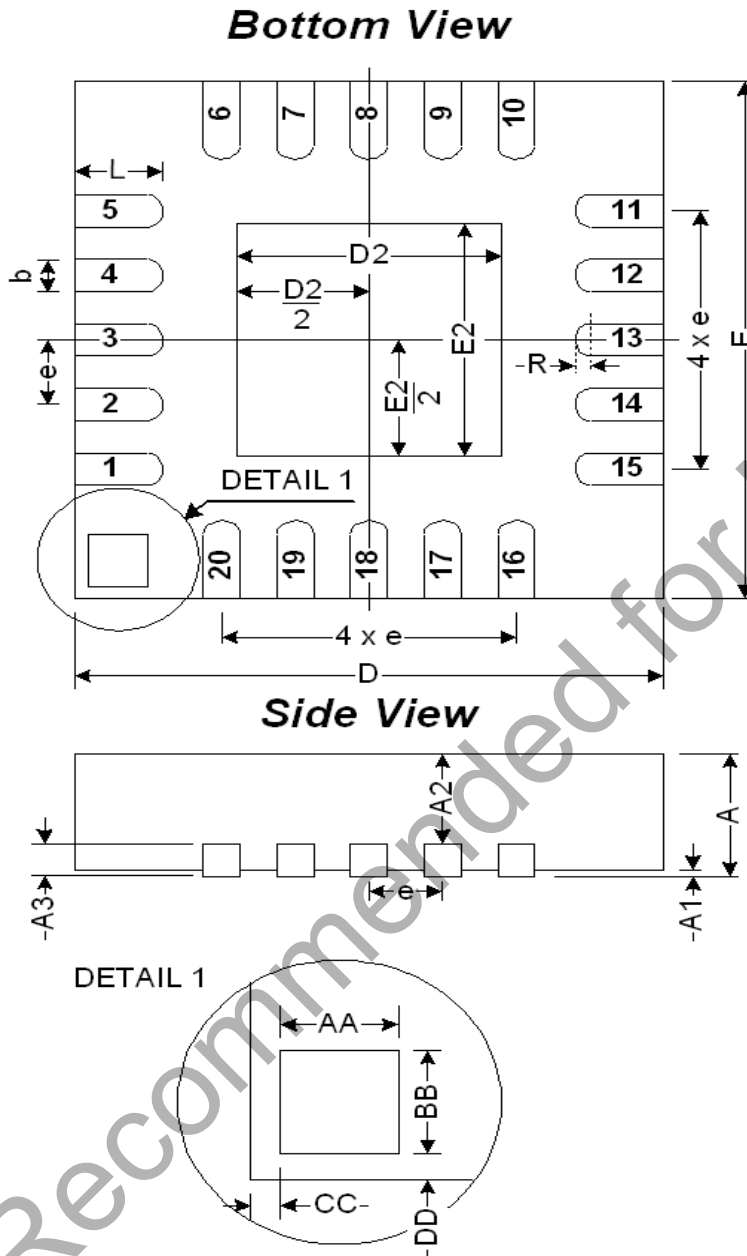

Table 4.1. QFN-20 Package Dimensions

	MM		
	MIN	TYP	MAX
A	0.80	0.90	1.00
A1	0	0.02	0.05
A2	0	0.65	1.00
A3	—	0.25	—
b	0.18	0.23	0.30
D	—	4.00	—
D2	2.00	2.15	2.25
E	—	4.00	—
E2	2.00	2.15	2.25
e	—	0.5	—
L	0.45	0.55	0.65
N	—	20	—
ND	—	5	—
NE	—	5	—
R	0.09	—	—
AA	—	0.435	—
BB	—	0.435	—
CC	—	0.18	—
DD	—	0.18	—

CP2120

4.4. QFN-20 Solder Paste Recommendations

Top View

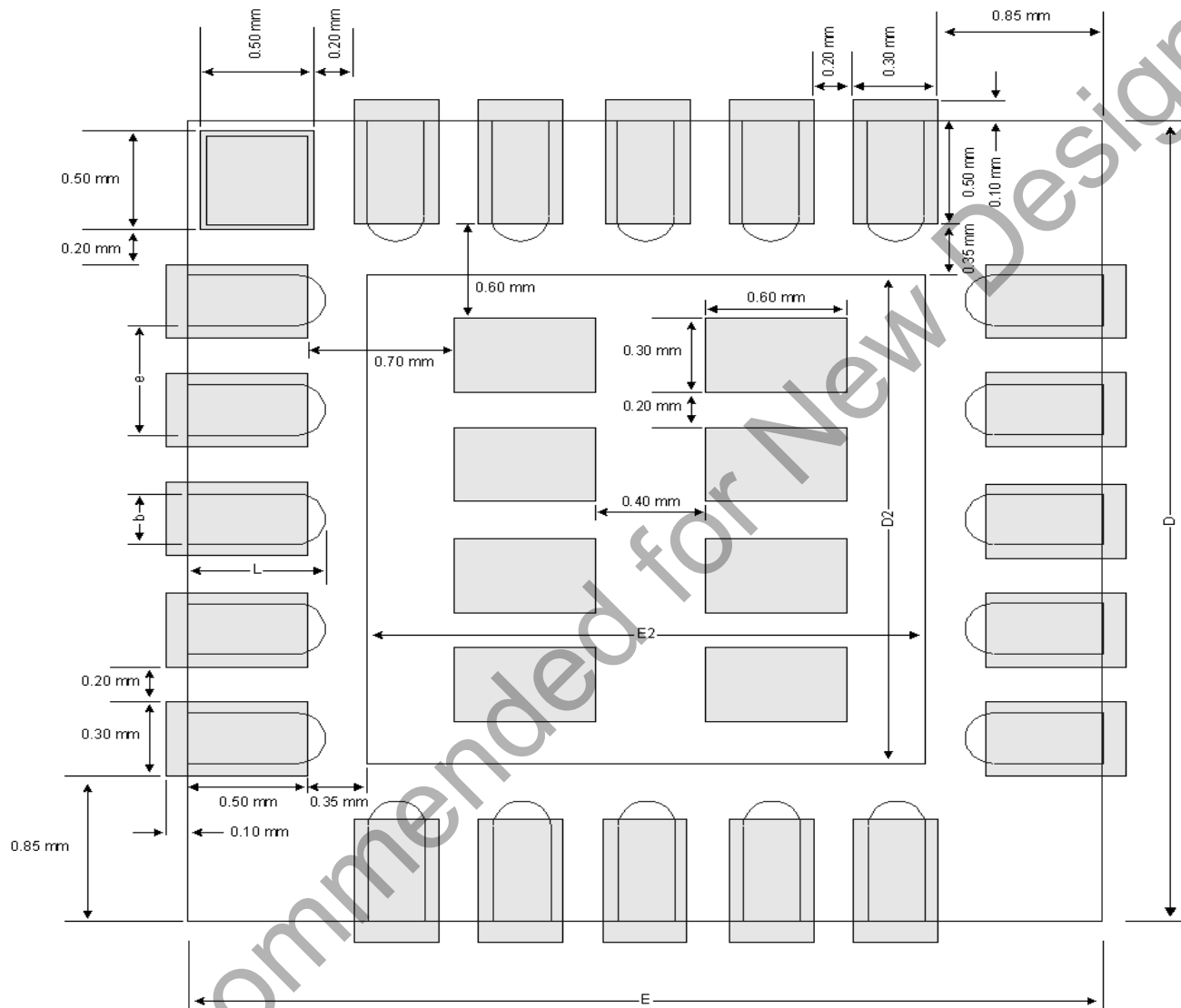

5. SPI Slave Bus

The CP2120 provides a four-wire slave SPI interface. The CP2120's SPI Bus activates whenever the SPI Master pulls the NSS pin low. The master can then clock data into the CP2120 through the Master-Out-Slave-In (MOSI) pin and receive data from the CP2120 through the Master-In-Slave-Out (MISO) pin. The SPI Master provides the SPI with a clock source. Figure 2 shows typical connections for an SPI bus.

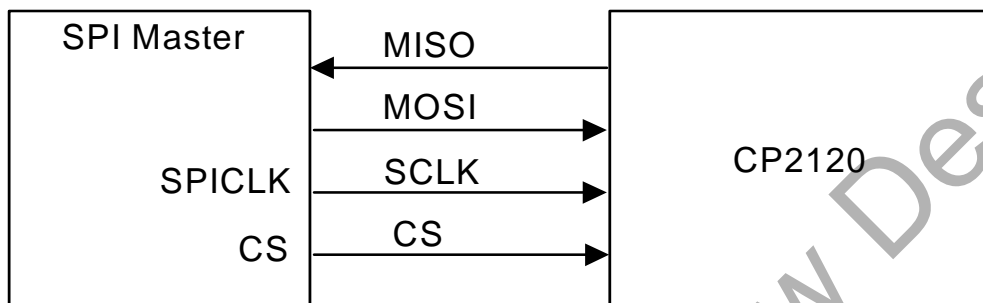

Figure 2. SPI Bus Typical Connections

SCLK should be held high when idle. Figure 3 shows a CP2120 data transfer on the SPI Bus. If the CP2120 is the only slave device on the SPI bus, the NSS pin can be tied low.

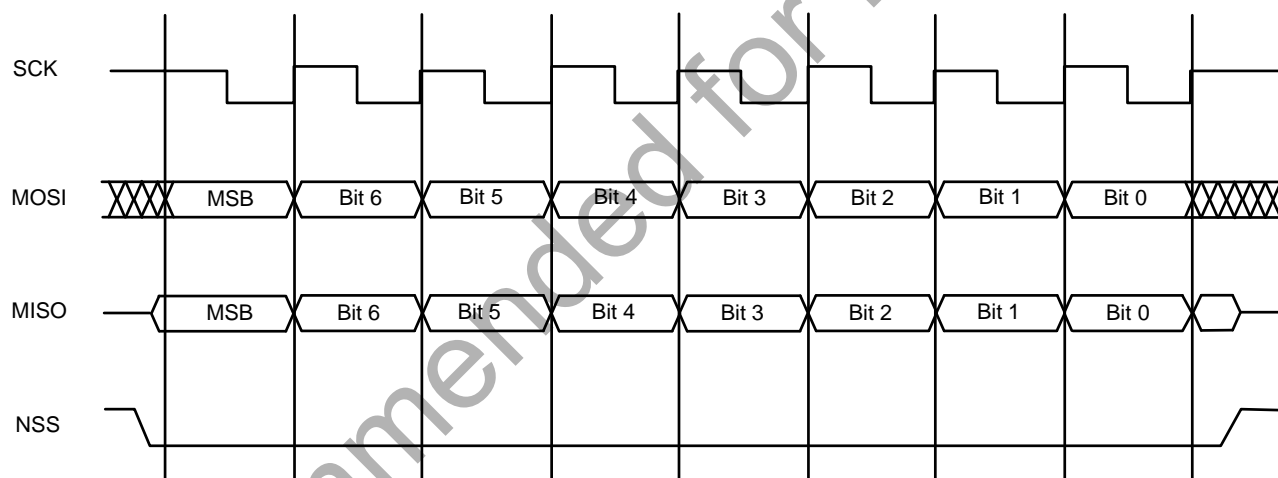

Figure 3. Slave Mode Data/Clock Timing

Note: Some SPI clock speeds in the 100 kHz to 300 kHz range may result in communication issues. Moving the clock rate faster or slower will resolve this problem.

CP2120

5.1. Command Set

An SPI Master controls the CP2120 by sending commands across the SPI bus. Some commands initiate I²C transactions, while other commands modify or monitor CP2120 operation and events.

5.2. Internal Registers

The CP2120 maintains a set of internal registers that can be modified to configure general purpose port I/O and I²C operation and can be read to obtain device status. Commands reading to and writing from the internal registers can be issued at any time, even while an I²C transaction is in progress, as they do not initiate any I²C bus transactions. Table 3 shows a list of all internal registers.

Table 3. Internal Register Addresses

Internal Register	Address	Section
IOCONFIG	0x00	7
IOSTATE	0x01	7
I2CCLOCK	0x02	6.1
I2CTO	0x03	6.1
I2CSTAT	0x04	6.2
I2CADR	0x05	6.1
RXBUFF	0x06	6.3
IOCONFIG2	0x07	7
EDGEINT	0x08	7
I2CTO2	0x09	6.1

5.2.1. Write to Internal Register

SPI Master	0x20 COMMAND	REGISTER X	DATA BYTE
------------	-----------------	---------------	-----------

A *Write to Internal Register* command updates the value of one of the CP2120's Internal Registers. A *Write to Internal Register* command begins with the command byte, 0x20, followed by the internal register address, followed by the new value of the internal register. Only one register can be accessed per *Write to Internal Register* command.

5.2.2. Read From Internal Register

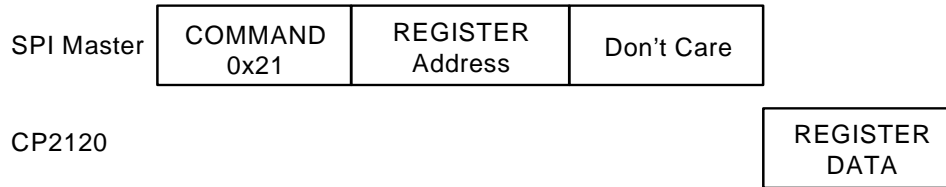

A *Read from Internal Register* command retrieves the current value of one of the CP2120's internal registers. The command begins with the command byte, 0x21, followed by the internal register address. This byte is followed by the transmission of a "don't care" byte, which can be of any value and is ignored by the CP2120. After the "don't care" byte, the internal register value is transmitted across the MISO line.

5.3. SPI Byte Orientation

The *SPI Configuration* command configures the bit orientation of transfers across the SPI bus to one of two states. If SPI transmits most-significant-bit first, bit 7 is transmitted first. If SPI transmits least-significant-bit first, bit 0 is transmitted first.

5.3.1. SPI Configuration



The command begins with the command byte (0x18), followed by *SPI Configuration* byte, which should equal one of the values shown in the following table. Any values other than those listed in the table are ignored.

Byte Value	Configuration
0x81	Most Significant Bit First
0x42	Least Significant Bit First

5.4. SPI Timing Diagrams

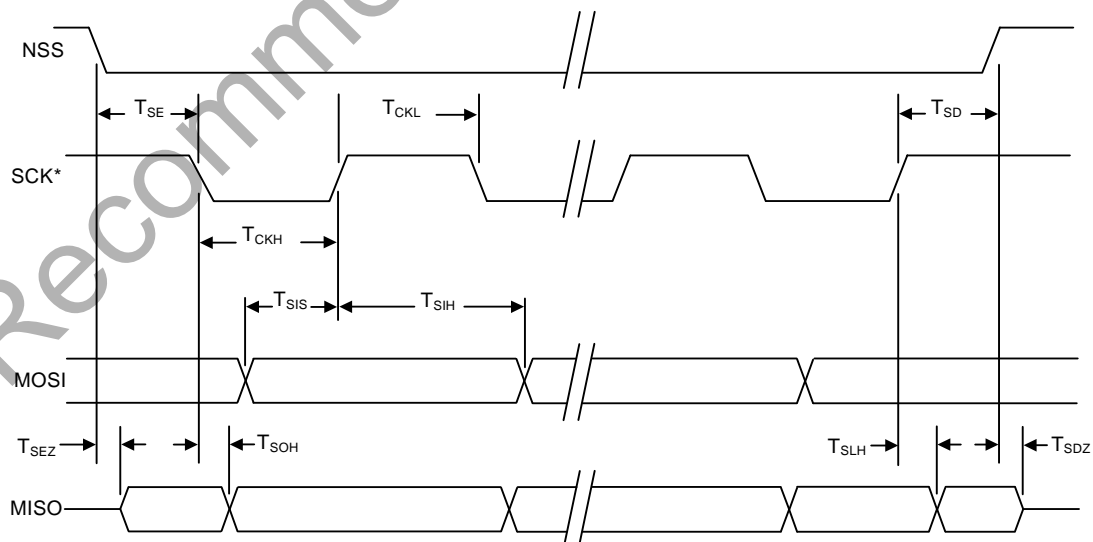

Figure 4. SPI Slave Timing

CP2120

Table 4. SPI Slave Timing Parameters

Slave Mode Timing* (See Figure 4)				
T_{SE}	NSS Falling to First SCLK Edge	$2 \times T_{SYSCLK}$	—	ns
T_{SD}	Last SCLK Edge to NSS Rising	$2 \times T_{SYSCLK}$	—	ns
T_{SEZ}	NSS Falling to MISO Valid	—	$4 \times T_{SYSCLK}$	ns
T_{SDZ}	NSS Rising to MISO High-Z	—	$4 \times T_{SYSCLK}$	ns
T_{CKH}	SCLK High Time	$5 \times T_{SYSCLK}$	—	ns
T_{CKL}	SCLK Low Time	$5 \times T_{SYSCLK}$	—	ns
T_{SIS}	MOSI Valid to SCLK Sample Edge	$2 \times T_{SYSCLK}$	—	ns
T_{SIH}	SCLK Sample Edge to MOSI Change	$2 \times T_{SYSCLK}$	—	ns
T_{SOH}	SCLK Shift Edge to MISO Change	—	$4 \times T_{SYSCLK}$	ns
T_{SLH}	Last SCLK Edge to MISO Change (CKPHA = 1 ONLY)	$6 \times T_{SYSCLK}$	$8 \times T_{SYSCLK}$	ns
*Note: T_{SYSCLK} equals 24.5 MHz.				

5.5. I²C Activity During SPI Transactions

If the SPI Master attempts to transmit a command to the CP2120 while the I²C bus is inactive, the CP2120 will disable its slave response. If an I²C Master device on the bus attempts to address the CP2120 during this time, the CP2120 will not ACK the address defined in the I2CADR Internal Register.

If the SPI Master attempts to transmit a command to the CP2120 while the CP2120 is acting as the Master on the I²C bus, the CP2120 will suspend I²C bus activity until the SPI Master has completed transmission of the command. For instance, if the SPI Master calls the Read Internal Register command while the CP2120 is in the middle of an I²C transaction, that I²C transaction will stall until the CP2120 completely processes the *Read Internal Register* command.

6. I²C Serial Interface

The CP2120 provides an I²C interface able to transfer data at frequencies up to 400 kHz. During a transaction, the CP2120, operating as the I²C master, sources a data clock on the SCL pin as data travels across the bidirectional SDA pin to and from an I²C slave device. The I²C interface lines each require a pull-up resistor. Figure 5 shows a typical I²C bus.

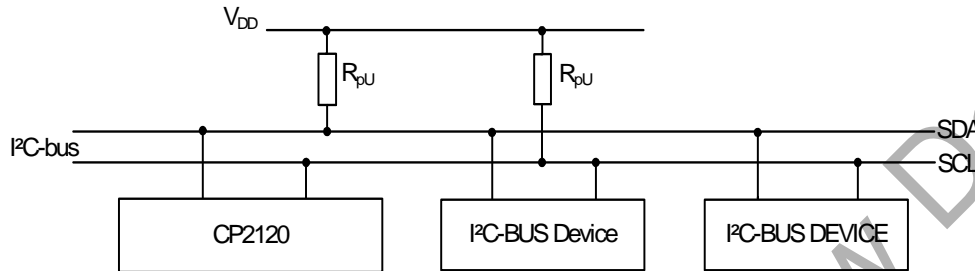

Figure 5. Typical I²C Bus*

Note: V_{DD} is defined in Table 2, “Absolute Maximum Ratings,” on page 4. For R_{pu} values, please see “6.1. Determining Pull-Up Register Values”.

Note: The I²C interface does not currently support repeated start transactions, as required by some I²C slave devices.

6.1. Determining Pull-Up Register Values

Logic low to logic high transitions on the SCL and SDA pins, which are configured to open-drain output with external pull-ups to V_{DD} , take the form of an exponential curve with an RC time constant, where C equals the capacitance of the bus and R equals the pull-up resistor value. I²C specification defines rise time as the time required for a signal level to change from $V_{min} + 0.15$ V to $V_{max} - 0.15$ V. By solving the exponential equation using a V_{min} of 0 V and a V_{max} of 3.3 V, the following equation can be used to find values for pull-up resistors:

$$\text{Rise time} = 3.04448 \text{ RC}$$

Bus capacitance is governed by a number of factors, including signal trace length and capacitance introduced by devices on the bus. 8 mm PCB signal traces on a two-layer board generally add 1 pF of capacitance per centimeter of trace length. To determine the amount of capacitance introduced to the bus by I²C devices, consult those devices’ datasheets. The maximum capacitance allowed before the bus violates I²C specification is 400 pF.

Rise time requirements vary depending on each connected I²C device’s timing requirements and the SCL clock frequency. The maximum rise time allowed by the I²C specification is 1000 ns.

6.2. I²C Internal Registers

Features of the I²C interface are configured through the CP2120’s Internal Registers. SCL clock frequency is set by writing to the I2CCLK Internal Register. The frequency can be determined using the equation below. The I²C frequency configured by the I2CCLOCK register is only an approximate frequency. Actual I²C frequencies can vary due to conditions on the bus, such as a slave device extending the SCL low time.

$$\text{I}^2\text{C Clock Frequency (kHz)} = \frac{2000}{\text{I}^2\text{CCLK}}$$

Equation 1. I²C Clock Frequency

CP2120

Internal Register Definition 1. I2CCLOCK: I²C Clock Frequency Configuration

R/W	R/W	R/W	R/W	R/W	R/W	R/W	R/W
I2CCK7	I2CCK6	I2CCK5	I2CCK4	I2CCK3	I2CCK2	I2CCK1	I2CCK0
Bit 7	Bit 6	Bit 5	Bit 4	Bit 3	Bit 2	Bit 1	Bit 0

Internal Register Address: 0x02
 Reset Value: 0xA0
 Bit 7-0: I2CCK7-0: I²C Clock Frequency Configuration value (minimum register value = 5, maximum register value = 255)

The transaction time-out counter, which terminates an I²C transaction after a set period of time has passed, can be configured through the I2CTO Internal Register. If the time-out counter is not enabled, the CP2120 will make only one attempt at executing an I²C transaction and abort if that transaction attempt fails.

$$\text{Time-out Frequency} = \frac{TO}{128} (\text{Hz})$$

Equation 2. CTO Time-Out Frequency

Internal Register Definition 2. I2CTO: I²C Time Out

R/W	R/W	R/W	R/W	R/W	R/W	R/W	R/W
TO6	TO5	TO4	TO3	TO2	TO1	TO0	TEN
Bit 7	Bit 6	Bit 5	Bit 4	Bit 3	Bit 2	Bit 1	Bit 0

Internal Register Address: 0x03
 Reset Value: 0x00
 Bit 7-1: TO6-0: Time Out Value
 Bit 0: TEN: Time Out Enable Bit.
 0: Disable Timer,
 1: Enable Timer.

The SPI Master can assign an I²C address to the CP2120 by writing to the I2CADR Internal Register. Setting this address is not necessary for device operation. If set, the CP2120 will ACK this address when another I²C Master on the bus attempts to communicate with it. The CP2120 will NACK all attempts at data transfer when responding as an I²C slave.

Internal Register Definition 3. I2CADR: I²C Address

R/W	R/W	R/W	R/W	R/W	R/W	R/W	R/W
I2CAD7	I2CAD6	I2CAD5	I2CAD4	I2CAD3	I2CAD2	I2CAD1	I2CAD0
Bit 7	Bit 6	Bit 5	Bit 4	Bit 3	Bit 2	Bit 1	Bit 0

Internal Register Address: 0x05
 Reset Value: 0x00
 Bit 7-Bit 0: I2CAD7-0: I²C Address
 Sets I²C bus address.

The SPI2I2C provides additional SMBus-related timers to enable I²C protocol compatibility. Setting the I²C Bus Free Detect enables the device to poll the SMBus lines and determine when a transfer can begin. Setting the SCL Low Time Out detect will cause an SMBus transaction to abort if the SCL line has been held low by a device for a period of approximately 25 ms.

Internal Register Definition 4. I2CTO2: Additional I²C Time Outs

R/W	R/W	R/W	R/W	R/W	R/W	R/W	R/W
Reserved	Reserved	Reserved	Reserved	Reserved	Reserved	FREN	LWEN
Bit 7	Bit 6	Bit 5	Bit 4	Bit 3	Bit 2	Bit 1	Bit 0

Internal Register Address: 0x09
 Reset Value: 0x00

Bit 1: I²C Bus Free Detect
 0: Bus Free Detect Disabled
 1: Bus Free Detect Enabled

Bit 0: I²C SCL Low Time Out Detect
 0: SCL Low Time Out Detect disable
 1: SCL Low Time Out Detect enable

6.3. I²C Status

The CP2120 maintains an Internal Register, I2CSTAT, which describes the current status of the I²C Interface. The I2CSTAT register can be read at any time. The CP2120 updates I2CSTAT when an I²C transaction begins, when an I²C transaction completes (successfully or unsuccessfully), and when a received SPI command contains errors. It is not recommended that an SPI master poll the CP2120's I2CSTAT Internal Register to determine when an I²C transaction has completed. The SPI master should instead watch for the INT pin to drop low, and then read the I2CSTAT register to determine the I²C transaction results.

CP2120

Internal Register Definition 5. I2CSTAT: I²C Status Register

R	R	R	R	R	R	R	R
I2ST7	I2ST6	I2ST5	I2ST4	I2ST3	I2ST2	I2ST1	I2ST0
Bit 7	Bit 6	Bit 5	Bit 4	Bit 3	Bit 2	Bit 1	Bit 0

Internal Register Address: 0x04

Reset Value: 0x00

Bit 7–0

I2ST: I²C Status

I ² C Status Value	Status Description
0xF0	I ² C transaction completed successfully.
0xF1	Slave address NACKed.
0xF2	Slave data NACKed.
0xF3	I ² C transaction in progress.
0xF8	I ² C transaction timed out due to timer configured in I2CTO.
0xF9	Command's Bytes to Transmit Byte and Data Buffer Size do not match, or Read Buffer read number of bytes greater than buffer count.
0xFA	I ² C SCL Low time-out, using timer configured in I2CTO2.
0xFB	I ² C bus free detect has been disabled, and the bus is not free.

6.4. I²C Receive Buffer Size

Bytes received from I²C transactions are stored in the 255-byte data buffer. The number of bytes currently stored inside this buffer is saved in the RXBUFF Internal Register.

Internal Register Definition 6. RXBUFF: Receive Buffer Size Register

R	R	R	R	R	R	R	R
RXB7	RXB6	RXB5	RXB4	RXB3	RXB2	RXB1	RXB0
Bit 7	Bit 6	Bit 5	Bit 4	Bit 3	Bit 2	Bit 1	Bit 0

Internal Register Address: 0x06
 Reset Value: 0x00
 Bit 7-0: RXB7-0: Receive Buffer Size
 Indicates the number of bytes received during the last I²C read transaction.

6.5. I²C Commands

SPI commands initiate all I²C transactions. The CP2120 executes I²C transactions only after every byte of the command has been successfully received across the SPI bus. Once the CP2120 has completed the I²C transaction prompted by the command, the INT pin will be pulled low to indicate that command execution has completed. If an I²C command is issued while an I²C command is in progress, the second I²C command will be ignored.

6.5.1. Write Bytes to I²C



This command transmits data to an I²C slave device. The command begins with the command byte (0x00), followed by the number of bytes to be transmitted across I²C, which can range from 1 to 255, and the address of the I²C Slave. The SPI master then sends the data to be transmitted across I²C. Sending more or fewer bytes than was indicated by the second byte of the command will result in an error condition, and the I²C transaction will not be initiated.

Once the I²C transaction completes, the CP2120 pulls the INT pin low and sets the internal register according to the results of the transaction.

6.5.2. Read Bytes from I²C

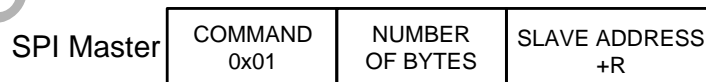

This command attempts to retrieve bytes from an I²C Slave device. The command begins with the command byte, 0x01, followed by the number of bytes to read (1 to 255) and the address of the I²C slave device.

Once the I²C transaction completes, the CP2120 pulls the INT pin low and sets I2CSTAT according to the results of the transaction. The CP2120 saves the number of bytes stored in the buffer in the internal register named RXBUFF. A *Read Buffer* command can be issued to retrieve the bytes from the buffer.

Note: If the SPI Master issues a second Read Bytes from I²C command before issuing a Read Buffer command, the bytes stored in the CP2120's buffer will be overwritten.

CP2120

6.5.3. Read Buffer

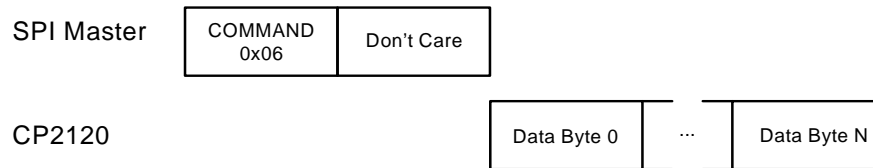

The *Read Buffer* command retrieves bytes from the CP2120's data buffer. The command begins with the command byte, 0x06. After the command byte, the SPI Master must transmit a single byte of data, which is ignored by the CP2120. After receiving the ignored byte of data, the CP2120 transmits data bytes across the MISO pin.

It is recommended that the SPI Master read the RXBUFF Internal Register to determine how many bytes are stored in the CP2120's buffer before issuing a *Read Buffer* command. If the SPI Master attempts to retrieve more bytes than the buffer contains, the CP2120 will signal the error in I2CSTAT. If an SPI Master attempts to retrieve fewer bytes than are stored in the data buffer, all bytes left in the buffer will be deleted when the *Read Buffer* command terminates.

6.5.4. Read After Write

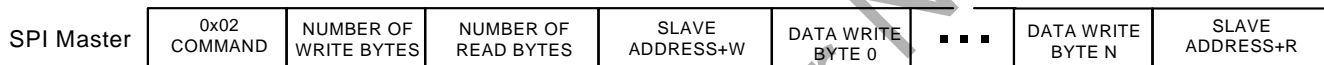

The *Read After Write* command writes bytes to one I²C slave and then reads bytes from another I²C slave. The SPI Master calls this command by first sending the command byte, 0x02, then the number of bytes to write (1 to 255) and bytes to read (1 to 255). These bytes are followed by the address of the I²C slave to which the CP2120 will attempt to write bytes, followed by the data bytes to write. The last byte of the command is the I²C slave from which the CP2120 will attempt to read bytes.

6.5.5. Write After Write



The *Write After Write* command writes to an I²C slave device and then issues another write to a second I²C slave device. The command begins with the command byte, 0x08, followed by the number of bytes to write to the first I²C device and the bytes to write to the second I²C device. The SPI master sends the slave address of the first I²C device and the data bytes to write to the first I²C slave. The SPI Master then sends the slave address of the second I²C slave device followed by the data bytes to transmit to that slave device.

6.5.6. Write To Multiple Slaves

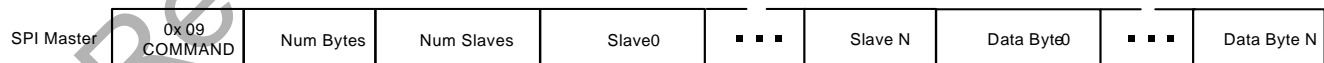

The *Write to Multiple Slaves* command allows an SPI Master to write the same data buffer to multiple I²C slaves. The command begins with the command byte, 0x09, followed by the size of the data buffer (0 to 255), followed by the number of slaves (0 to 254). Next, the list of slave addresses is transmitted. Following that, the data buffer to write to each slave is transmitted. The combined size of the slave address list and the data buffer should not exceed 255 bytes. The I2CSTAT Internal Register shows the results from the last I²C transaction of the command.

7. Port I/O

The CP2120 offers eight general-purpose port pins that can be configured as output, input, or quasi-bidirectional output by writing to the internal registers, IOCONFIG and IOCONFIG2. Pin state can be updated by writing to the internal register, IOSTATE. Reading the IOSTATE Internal Register will return the current values of each port pin.

The port pin, EINT, can be configured as an edge-triggered interrupt source by writing to the EDGEINT Internal Register. The EIT bit sets the interrupt to trigger upon a 0 to 1 or a 1 to 0 logic change on the pin. The bit, EIE, enables the pin as an interrupt source.

Once the interrupt has been configured and enabled, the CP2120 will pull the INT pin low when the port pin's logic value switches to "1" or "0", depending on the interrupt configuration specified in the EIT bit. When an interrupt is triggered, EIF in the EDGEINT Internal Register is set. Reading from EDGEINT will clear the EIF bit.

Internal Register Definition 7. IOCONFIG: Port I/O Configuration

R/W	R/W	R/W	R/W	R/W	R/W	R/W	R/W
PCIO3.1	PCIO3.0	PCIO2.1	PCIO2.0	PCIO1.1	PCIO1.0	PCIO0.1	PCIO0.0
Bit 7	Bit 6	Bit 5	Bit 4	Bit 3	Bit 2	Bit 1	Bit 0

Internal Register Address: 0x00
Reset Value: 0x00
Bit 7-6: PCIO3.1-PCIO3.0: Port Configuration for GPIO Pin 3
Bit 5-4: PCIO2.1-PCIO2.0: Port Configuration for GPIO Pin 2
Bit 3-2: PCIO1.1-PCIO1.0: Port Configuration for GPIO Pin 1
Bit 1-0: PCIO0.1-PCIO0.0: Port Configuration for GPIO Pin 0
These bits select the port state for GPIO pins 3 through 0.

PCIOx.1	PCIOx.0	GPIO Pin x Mode
0	0	Open Drain Output
0	1	Input Only
1	0	Push-Pull Output
1	1	Reserved

CP2120

Internal Register Definition 8. IOCONFIG2: Port I/O Configuration 2

R/W	R/W	R/W	R/W	R/W	R/W	R/W	R/W
PCIO7.1	PCIO7.0	PCIO6.1	PCIO6.0	PCIO5.1	PCIO5.0	PCIO4.1	PCIO4.0
Bit 7	Bit 6	Bit 5	Bit 4	Bit 3	Bit 2	Bit 1	Bit 0

Internal Register Address: 0x07
Reset Value: 0x00

Bit 7-6: PCIO7.1-PCIO7.0: Port Configuration for GPIO Pin 7
Bit 5-4: PCIO6.1-PCIO6.0: Port Configuration for GPIO Pin 6
Bit 3-2: PCIO5.1-PCIO5.0: Port Configuration for GPIO Pin 5
Bit 1-0: PCIO4.1-PCIO4.0: Port Configuration for GPIO Pin 4
These bits select the port state for GPIO pins 7 through 4.

PCIOx.1	PCIOx.0	GPIO Pin x Mode
0	0	Open Drain Output
0	1	Input Only
1	0	Push-Pull Output
1	1	Input Only

Internal Register Definition 9. IOSTATE: Port I/O State

R/W	R/W	R/W	R/W	R/W	R/W	R/W	R/W
GPIO7	GPIO6	GPIO5	GPIO4	GPIO3	GPIO2	GPIO1	GPIO0
Bit 7	Bit 6	Bit 5	Bit 4	Bit 3	Bit 2	Bit 1	Bit 0

Internal Register Address: 0x01
Reset Value: 0x00

Bit 7-0: GPIO7-0: General Purpose Input/Output State
Write - Output appears on output pins.
0: GPIOx set to logic low output.
1: GPIO set to logic high output.
Read - Reads port state.
0: GPIOx is logic low.
1: GPIOx is logic high.

Internal Register Definition 10. EDGEINT: Edge Triggered Interrupt Enable

R/W	R/W	R/W	R/W	R/W	R/W	R/W	R/W
EIF	EIE	EIT	Rsvd	Rsvd	Rsvd	Rsvd	Rsvd
Bit 7	Bit 6	Bit 5	Bit 4	Bit 3	Bit 2	Bit 1	Bit 0

Internal Register Address: 0x08
Reset Value: 0x00

Bit 7: EIF: Edge Triggered Interrupt Flag
0: No edge triggered event has occurred on the EI_INT pin.
1: Edge-triggered event has occurred on the EI_INT pin.

Bit 6: EIE: Edge Triggered Interrupt Enable
0: Edge Triggered interrupts disabled.
1: Edge Triggered interrupts enabled.

Bit 5: EIT: Edge Triggered Interrupt Trigger
0: Interrupt triggered on negative-to-positive digital transition on the EI_INT port pin.
1: Interrupt triggered on positive-to-negative digital transition on the EI_INT port pin.

Bit 4–Bit 0: Not used.

CP2120

8. CP2120 Revision Number

The CP2120 revision number can be retrieved by first sending the *Revision Number* command byte of 0x40 and then transmitting one “don’t care” transitional byte. The CP2120 then transmits the two-byte revision number, most significant byte first, in BCD format. For example, a transmitted byte sequence of “0x01 0x44” would indicate that the CP2120’s revision number is equal to 1.44.

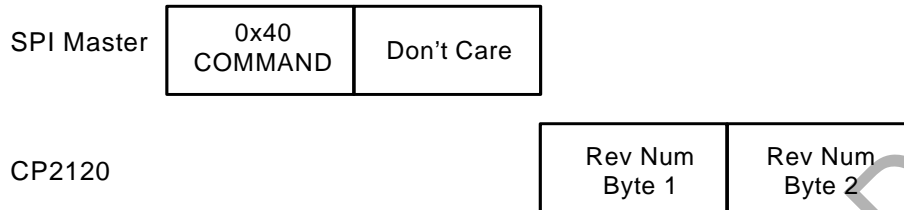

DOCUMENT CHANGE LIST

Revision 0.1 to Revision 0.2

- Various small text changes.
- Updated 4.1 Pin Out Chart.
- Updated 4.2 Pin Out Diagram.
- Updated Figure 2. SPI Bus Typical Connections.
- Added Table 3. Internal Register Addresses.
- Updated all CP2120 command drawings.
- Added section 6.1 Determining Pull-Up Register Values.
- Changed appearance of all Internal Register Definition charts.
- Changed contents of Section 8. CP2120 Revision Number.

Revision 0.2 to Revision 0.3

- Removed references to power down mode.
- Corrected Equation 1, "I2C Clock Frequency," on page 13.
- In Internal Register 4, "I2CTO2: Additional I²C Time Outs," on page 15, changed Internal Register Address to "0x09".
- In Internal Register 5, "I2CSTAT: I²C Status Register," on page 16, changed all bits to "R" instead of "R/W".
- In Internal Register 6, "RXBUFF: Receive Buffer Size Register," on page 17, changed all bits to "R" instead of "R/W".

Revision 0.3 to Revision 0.4

- Updated Figure 1.
- Updated Digital Supply Voltage in Table 2.
- Updated Figure 3.

Revision 0.4 to Revision 1.0

- Updated CS and INT to have the overbar in Section 4.1.
- Added V_{RST} parameter to Table 1 on page 4.
- Updated the description of Register 7, "IOCONFIG: Port I/O Configuration," on page 19 to describe 11b as Reserved.
- Added a note regarding no repeated start support in Section 6 on page 13.
- Added a note regarding SPI clock speeds to Section 5 on page 9.



Simplicity Studio

One-click access to MCU and wireless tools, documentation, software, source code libraries & more. Available for Windows, Mac and Linux!



IoT Portfolio
www.silabs.com/loT



SW/HW
www.silabs.com/simplicity



Quality
www.silabs.com/quality



Support and Community
community.silabs.com

Disclaimer

Silicon Labs intends to provide customers with the latest, accurate, and in-depth documentation of all peripherals and modules available for system and software implementers using or intending to use the Silicon Labs products. Characterization data, available modules and peripherals, memory sizes and memory addresses refer to each specific device, and "Typical" parameters provided can and do vary in different applications. Application examples described herein are for illustrative purposes only. Silicon Labs reserves the right to make changes without further notice and limitation to product information, specifications, and descriptions herein, and does not give warranties as to the accuracy or completeness of the included information. Silicon Labs shall have no liability for the consequences of use of the information supplied herein. This document does not imply or express copyright licenses granted hereunder to design or fabricate any integrated circuits. The products are not designed or authorized to be used within any Life Support System without the specific written consent of Silicon Labs. A "Life Support System" is any product or system intended to support or sustain life and/or health, which, if it fails, can be reasonably expected to result in significant personal injury or death. Silicon Labs products are not designed or authorized for military applications. Silicon Labs products shall under no circumstances be used in weapons of mass destruction including (but not limited to) nuclear, biological or chemical weapons, or missiles capable of delivering such weapons.

Trademark Information

Silicon Laboratories Inc.®, Silicon Laboratories®, Silicon Labs®, SiLabs® and the Silicon Labs logo®, Bluegiga®, Bluegiga Logo®, Clockbuilder®, CMEMS®, DSPLL®, EFM®, EFM32®, EFR®, Ember®, Energy Micro, Energy Micro logo and combinations thereof, "the world's most energy friendly microcontrollers", Ember®, EZLink®, EZRadio®, EZRadioPRO®, Gecko®, ISOModem®, Precision32®, ProSLIC®, Simplicity Studio®, SiPHY®, Telegesis, the Telegesis Logo®, USBXpress® and others are trademarks or registered trademarks of Silicon Labs. ARM, CORTEX, Cortex-M3 and THUMB are trademarks or registered trademarks of ARM Holdings. Keil is a registered trademark of ARM Limited. All other products or brand names mentioned herein are trademarks of their respective holders.



Silicon Laboratories Inc.
 400 West Cesar Chavez
 Austin, TX 78701
 USA

<http://www.silabs.com>

OUR CERTIFICATE

DiGi provide top-quality products and perfect service for customer worldwide through standardization, technological innovation and continuous improvement. DiGi through third-party certification, we stricly control the quality of products and services. Welcome your RFQ to

Email: Info@DiGi-Electronics.com



Tel: +00 852-30501935

RFQ Email: Info@DiGi-Electronics.com

DiGi is a global authorized distributor of electronic components.